

# awave

*Owner's Manual*  
**Digital Signal Processor**



## **DSP-12D**

**DIGITAL SIGNAL PROCESSOR**

**INDEX**

1. PRODUCT DESCRIPTION-PRECAUTIONARY NOTES.....02

2. PACKAGING CONTENTS.....02

3. DSP AND DRC INSTALLATION.....03

4. CONNECTION PANELS-DESCRIPTION.....04

    4.1 Input signals .....04

5. SOFTWARE INSTALLATION.....05

    5.1 DSP GUI installation .....05-06

6. GUI OPERATION INSTRUCTION.....06

    6.1 Guide to GUI after installation .....06

    6.2 Interface introduction .....06

7. INTERFACE INTRODUCTION.....07-11

8. REMOTE INTRODUCTION.....12







9 . TECHNICAL FEATURES.....12

**1.PRODUCT DESCRIPTION-PRECAUTIONARY NOTES**

The DSP is a digital signal processor essential to maximize the acoustic performance of your car audio system. It consists of a 32-bit DSP processor and 24-bit AD and DA converters. It can connect to any factory system, even in vehicles featuring an integrated audio processor, since, thanks to the De-equalization function, the DSP will send back a linear signal. It features selectable High and low level inputs as well as 3.5MM Aux and digital inputs that feed 8 completely variable output channels. Each output channel has a 31-band equalizer available. It also features a 66-frequency electronic crossover as well as BUTTERWORTH or LINKWITZ filters with 6-24dB slopes and a digital time delay line. The user can select adjustments. That allow him or her to interact with the DSP through a remote control device called DRC.

**WARNING:** 1-a PC provided with Windows XP, Windows Vista or Windows 7 operating system, 1.5GHz minimum. Processor speed, 1 GB RAM minimum memory and a graphics card with a minimum resolution. Of 1024x600 pixels are required to install the software and setup the DSP.  
2-Before connecting your DSP, carefully read this manual. Improper connections may cause damage to the DSP or to the speakers in the car audio system.

**2.PACKAGING CONTENTS**

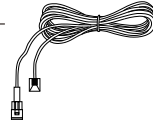
- DSP- Signal Interface Processor 
  - Power supply cable/Remote/wifi/Inputs 
  - 5.0m USB cable 
  - Control High Level Input 
  - 4 of 4.0\*15 mm self-tapping, Cross-head fixing screws, 
- OPTIONAL:**
- DRC(Digital Remote Control)control panel: 
  - 5.0 m DRC-AC Link cable 

### 3.DSP AND DRC INSTALLATION

#### External dimensions

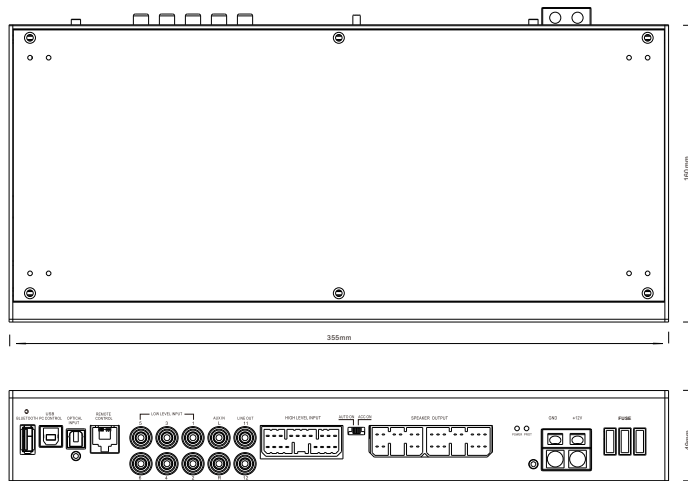

#### How to install



WARNING: do not use aggressive cleaning agents or abrasive cloth to clean the display. Simply use a soft cotton cloth lightly damped with water.

### 4.CONNECTION PANELS-DESCRIPTION

#### 4.1 Input signals

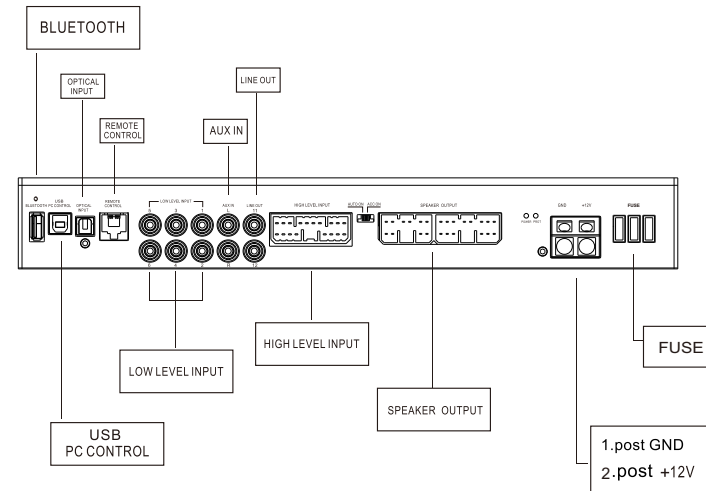

## 5. SOFTWARE INSTALLATION

### 5.1 DSP GUI installation

#### 1. Insert CD, Double-Click DSP

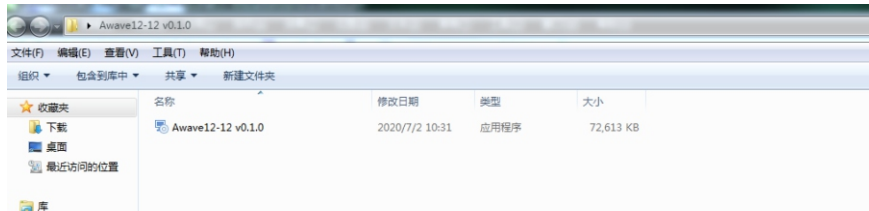

#### 2. Click NEXT



#### 3. Click NEXT



#### 4. Click NEXT

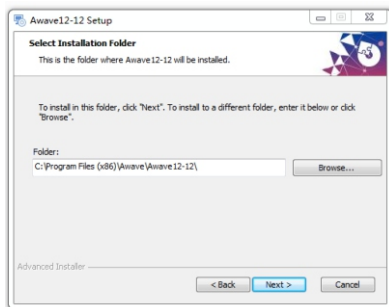

#### 5. Click NEXT

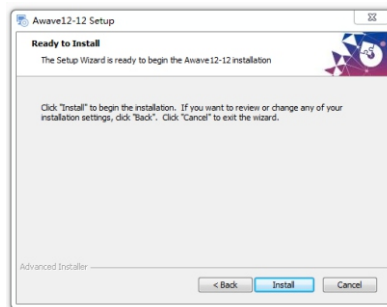

#### . Click NEXT

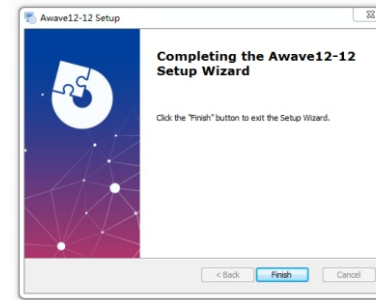

## 6 .GUI OPERATION INSTRUCTION

### 6.1 Guide to GUI after installation

#### 1. Double - click icon of DSP-CONTROL

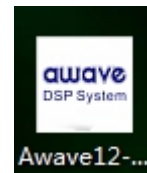

3. Enter the GUI you long for! Now you could tone every signal details as experts do To bring sound effect on your beloved car to a higher level.If the password has been set, You need to enter the password.



7.2 Interface introduction  
1.DSP interface guidance



2. "FILE" MAIN MENU 1

1. Connect(connect to the DSP)

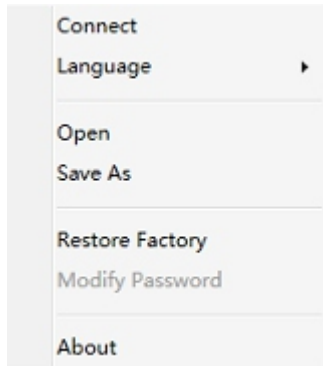

2. Language(choose you need language)

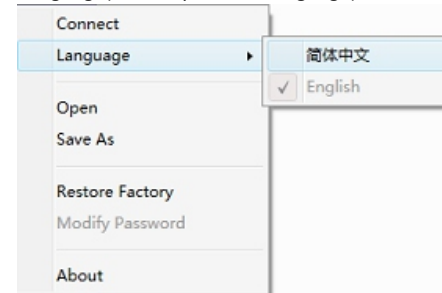

- 3. Open(To load preset file in PC folder)
- 4. Save(To save setting to PC)
- 5. Save as(To save another file setting to PC)
- 6. Restore Factory(To save preset file in DSP)
- 7.Modify Password

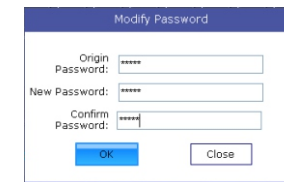
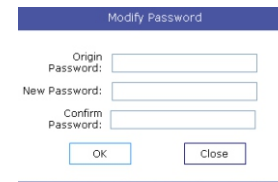

- 9. Read From Device
- 10. About
- 11. Exit

3. INPUT MODE.  
To select different input devices.

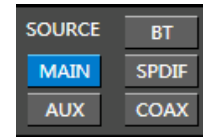

4. CHANNAL SETTING.  
① CH mode(2CH 4CH 6CH MIX).

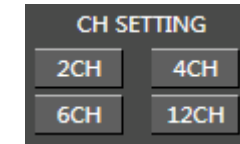

② Input channel: 1. 2. 3. 4. 5. 6. 7. 8. 9. 10.11.12

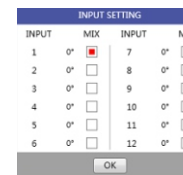

1  When highlighted red is selected, this channel input is indicated. If two or more are selected, this channel input is indicated

2 0° Click 0° to switch to 180°, corresponding to the output of this channel

③ Output channel:FL FullRange.FR FullRange.

When you click the drop-down button, you can choose the state of the channel input.  
There is : Null.Front.Rear.Center.Subwoofer and Full.Tweeter.Mid-T.Midrange.M-WF. Woofer.

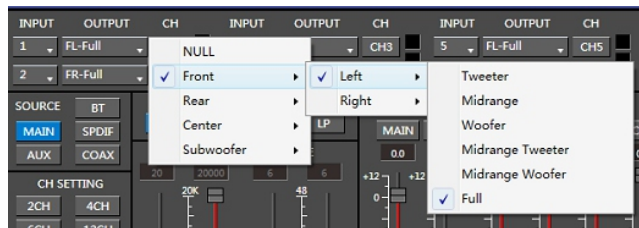

Options on the "Link" are for combine setting for Left CH and Right CH .  
Options on the Left CH/right CH allow you tone each selected channel respectively.

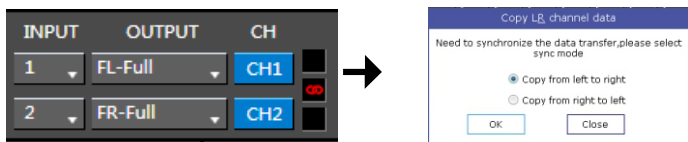

5. CROSSOVER X-TPE.

To choose different crossover type, for example select CH selection on 3RD spot .that would locate CH you want to choose for crossover configuration .



6. CROSSOVER FREQUENCY.

Set frequency of LP/HP individually .

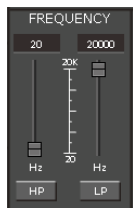

7. GAIN.

0--40dB is optional range for gain control kf every CH.

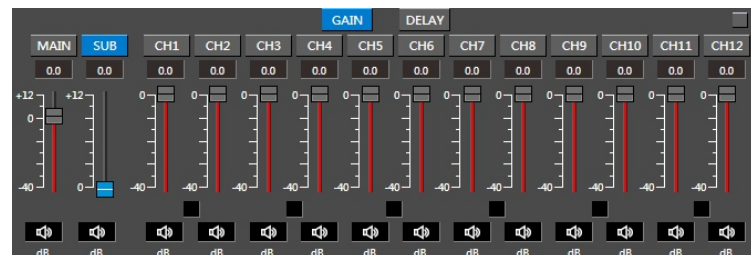

8. DELAY.

- 1.Auto configuration(base on 1.5 setting).
- 2.Manual configuration, change specifications in selected CH manually.

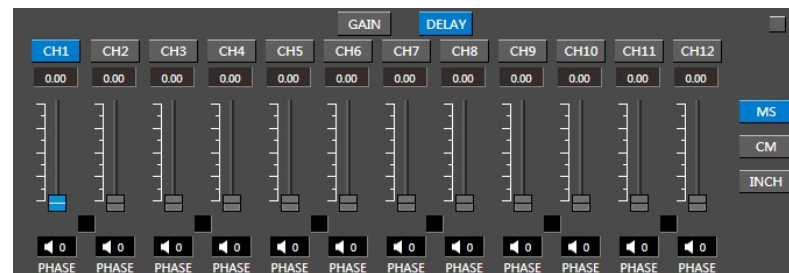

9. LP/SLOPE.

1.6dB/oct 12dB/oct 18dB/oct 24dB/oct 30dB/oct 36dB/oct. 42dB/oct 48dB/oct are available.

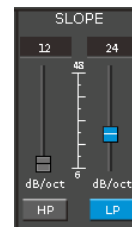

10. HP/SLOPE.

1.6dB/oct 12dB/oct 18dB/oct 24dB/oct 30dB/oct 36dB/oct.42dB/oct 48dB/oct are available.



11. Filter Model.

To choose different Filter type Linkwitz Bessel Butterworth.

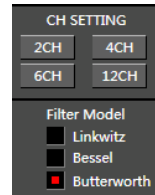

12. WRITE.

To Write To Device(POS1-POS8).

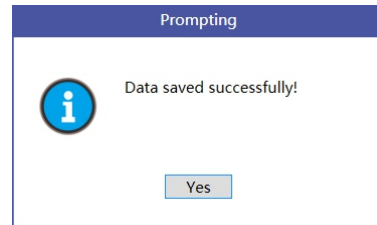
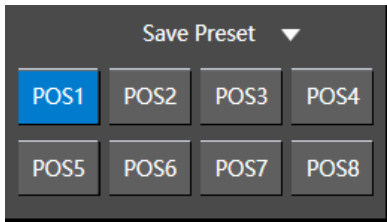

13. READ.

To Read From Device(POS1-POS8).

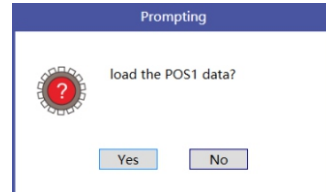
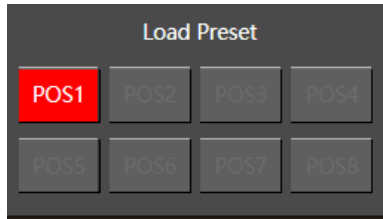

14. X-OVER AND EQ CHARTS.

- 1.Red lines and slopes will change accordingly when HP/LP of crossover and EQ are modified.
- 2.EQ all frequency points can be move left or right.For 20Hz-20KHz can be any Regulation.

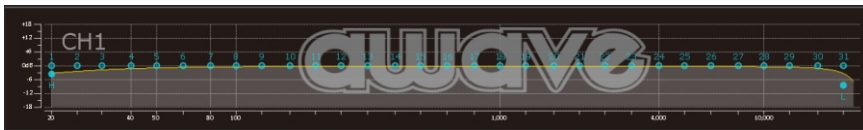

15. EQ SETTING.

Q value=1-12.



8.REMOTE INTRODUCTION



1. A.Main volume.  
 B.When you press this button for a short time,It is in the "MUTE" state. And theclose "MUTE".  
 C.When you press this button for a longer time(for a second) ,It will enter the menu mode .  
 In the "MODE" or "INPUT" flashing. You can adjust the mode which you want.
- 2.Main volume display window.
- 3.DSP mode display window(1-8).
- 4.Input display status.(CD.AUX.SPDIF.WIFI).

9.TECHNICAL FEATURES

POWER SUPPLY	
Voltange	9.0-15VDC
Idling current	1.5A
Switched off without DRC	5mm
Switched off with DRC	4mA
Remote IN voltage	6-15 VDC
Remote OUT voltage	12 VDC(130mA)

SIGNAL STAGE	
Distortion - THD @ 1kHz, 1V RMS Output	0.01%
Bandwith @-3 dB	10-20kHz
S/N ratio Full Power A-	90 dB
Hight level input range	3V-15V
THD+N VS Power 1%	(CH1/CH2/CH3/CH4/CH5/CH6/CH7/CH8/CH9/CH10/CH11/CH12)12X 80WATTS

INPUT STAGE	
High Level(Speaker)	1. 2. 3. 4. 5. 6. 7. 8. 9. 10.11.12 in
Low level(Pre)	1. 2. 3. 4. 5. 6 AUX in

CONNECTION	
From/To Personal Computer	1 x USB/B(1.1/2.0) 5M

CROSSOVER N.5(one each output channel)	
Filter Type	Full/High/Low Pass /Band Pass
Slope Setting	6/12/18/24/30/42/48 dB
Crossover frequency	68 steps @ 20- 20kHz
Phase control indepent setting for each channel	0 - 180°