

Manual

FD-R Extended.2

Item no. 42-01170 | 42-01171 | 42-01173

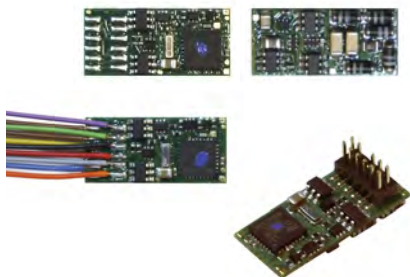

Function decoder

MM

DCC



tams elektronik



Contents

1. Getting started.....	4
2. Safety instructions.....	6
3. Safe and correct soldering.....	9
4. Operation overview.....	10
4.1. Modes of operation.....	10
4.2. Function outputs.....	11
4.3. Sound functions.....	13
4.4. Servo outputs and switching inputs.....	13
4.5. Releasing the actions.....	13
4.6. Feedback with RailCom**.....	14
4.7. POM-update.....	16
5. Technical specifications.....	17
6. Connections.....	19
6.1. Connector pin assignment.....	20
6.2. Using a FD-R Extended.2 with PluX12-interface connector... ..	22
6.3. Connection to the voltage supply.....	23
6.4. Connecting accessories to the outputs.....	24
6.5. Connecting LEDs to the function outputs.....	25
6.6. Connecting inductive loads.....	28
6.7. Connecting accessories via a relay.....	28
6.8. Connecting a loudspeaker.....	29
6.9. Connecting a buffer capacitor.....	30
6.10. Connecting a servo.....	32
6.11. Connecting the switching inputs.....	33
6.12. Connecting an impulse generator.....	34
6.13. Fixing the decoder.....	34

7. Programming.....	35
8. Configuration variables and registers.....	38
8.1. Setting the address.....	38
8.2. Information (Readable in DCC format only!).....	39
8.3. Auxiliary functions.....	40
8.4. Basic settings.....	41
8.5. Use of X13 and X14.....	46
8.6. Function mapping.....	48
8.7. Effects of the outputs.....	56
9. Performing a POM-Update.....	59
10. Check list for troubleshooting.....	61
11. Guarantee bond.....	66
12. EU declaration of conformity.....	67
13. Declarations conforming to the WEEE directive.....	67

© 10/2018 Tams Elektronik GmbH

All rights reserved. No part of this publication may be reproduced or transmitted in any form or by any means, electronic or mechanical, including photocopying, without prior permission in writing from Tams Elektronik GmbH.

Subject to technical modification.

The asterisks **

This manual mentions the following companies:

Gebr. MÄRKLIN & Cie. GmbH

Stuttgarter Str. 55-57 | DE-73033 Göppingen

1. Getting started

How to use this manual

This manual gives step-by-step instructions for safe and correct fitting and connecting of the decoder, and operation. Before you start, we advise you to read the whole manual, particularly the chapter on safety instructions and the checklist for trouble shooting. You will then know where to take care and how to prevent mistakes which take a lot of effort to correct.

Keep this manual safely so that you can solve problems in the future. If you pass the decoder on to another person, please pass on the manual with it.

Intended use

The function decoder FD-R Extended.2 is designed to be operated according to the instructions in this manual in model building, especially in digital model railroad layouts. Any other use is inappropriate and invalidates any guarantees.

The function decoder FD-R Extended.2 should not be mounted by children under the age of 14. Reading, understanding and following the instructions in this manual are mandatory for the user.

Checking the package contents

Please make sure that your package contains:

- one or five function decoders, depending on the version
 - without soldered connecting wires or
 - with soldered connecting wires or
 - with PluX12 connector;
- one or five buffer electrolytic capacitors (100 μ F / 25 V);
- one or five suppression chokes (470 μ H / 90 mA);
- a CD (containing the manual, Software "POM-Updater.exe" and further information).

Required materials

For mounting and connecting the decoder you need:

- an electronic soldering iron (max. 30 Watt) or a regulated soldering iron with a fine tip and a soldering iron stand,
- a tip-cleaning sponge,
- a heat-resistant mat,
- a small side cutter, a wire stripper and a pair of tweezers,
- electronic tin solder (0.5 mm diameter).

In order to connect decoders without soldered connecting wires or PluX12 interface you will need:

- wire. Recommended cross sections $\geq 0.04 \text{ mm}^2$ for all connections.

For playing back the sounds you need:

- a loudspeaker with an impedance of min. 4 Ohm and a rated load-carrying capacity of min. 0,1 Watt.

If you want to release switching operations automatically and/or perform speed or distance measurements as a basis for dynamic RailCom information, you need:

- reed contacts 1 x closing contact (e.g. item-no. 84-53110) and/or
- Hall-sensors (e.g. item-no. 84-53210);
- permanent magnets (e.g. neodymium magnets \varnothing 3mm, thickness = 2mm, item-no. 84-53990).

If you want to use the servo-outputs:

- one or two servos,
- voltage supplies for the servo(s), e.g. servo PCB item-no. 70-05900.

2. Safety instructions



Caution:

Integrated circuits (ICs) are inserted on the decoder. They are sensitive to static electricity. Do not touch components without first discharging yourself. Touching a radiator or other grounded metal part will discharge you.

Mechanical hazards

Cut wires can have sharp ends and can cause serious injuries. Watch out for sharp edges when you pick up the PCB.

Visibly damaged parts can cause unpredictable danger. Do not use damaged parts: recycle and replace them with new ones.

Electrical hazards

- Touching powered, live components,
- touching conducting components which are live due to malfunction,
- short circuits and connecting the circuit to another voltage than specified,
- impermissibly high humidity and condensation build up

can cause serious injury due to electrical shock. Take the following precautions to prevent this danger:

- Never perform wiring on a powered module.
- Assembling and mounting the kit should only be done in closed, clean, dry rooms. Beware of humidity.
- Only use low power for this module as described in this manual and only use certified transformers.
- Connect transformers and soldering irons only in approved mains sockets installed by an authorised electrician.
- Observe cable diameter requirements.
- After condensation build up, allow a minimum of 2 hours for dispersion.

- Use only original spare parts if you have to repair the kit or the ready-built module.

Fire risk

Touching flammable material with a hot soldering iron can cause fire, which can result in injury or death through burns or suffocation. Connect your soldering iron or soldering station only when actually needed. Always keep the soldering iron away from inflammable materials. Use a suitable soldering iron stand. Never leave a hot soldering iron or station unattended.

Thermal danger

A hot soldering iron or liquid solder accidentally touching your skin can cause skin burns. As a precaution:

- use a heat-resistant mat during soldering,
- always put the hot soldering iron in the soldering iron stand,
- point the soldering iron tip carefully when soldering, and
- remove liquid solder with a thick wet rag or wet sponge from the soldering tip.

Dangerous environments

A working area that is too small or cramped is unsuitable and can cause accidents, fires and injury. Prevent this by working in a clean, dry room with enough freedom of movement.

Other dangers

Children can cause any of the accidents mentioned above because they are inattentive and not responsible enough. Children under the age of 14 should not be allowed to work with this kit or the ready-built module.

**Caution:**

Little children can swallow small components with sharp edges, with fatal results! Do not allow components to reach small children.

In schools, training centres, clubs and workshops, assembly must be supervised by qualified personnel.

In industrial institutions, health and safety regulations applying to electronic work must be adhered to.

3. Safe and correct soldering

**Caution:**

Incorrect soldering can cause dangers through fires and heat. Avoid these dangers by reading and following the directions given in the chapter **Safety instructions**.

- Use a small soldering iron with max. 30 Watt. Keep the soldering tip clean so the heat of the soldering iron is applied to the solder point effectively.
- Only use electronic tin solder with flux.
- When soldering electronic circuits never use soldering-water or soldering grease. They contain acids that can corrode components and copper tracks.
- Solder quickly: holding the iron on the joints longer than necessary can destroy components and can damage copper tracks or soldering eyes.
- Apply the soldering tip to the soldering spot in such a way that the wire and the soldering eye are heated at the same time. Simultaneously add solder (not too much). As soon as the solder becomes liquid take it away. Hold the soldering tip at the spot for a few seconds so that the solder flows into the joint, then remove the soldering iron.
- The joint should be held still for about 5 seconds after soldering.
- To make a good soldering joint you should use a clean and unoxidised soldering tip. Clean the soldering tip with a damp piece of cloth, a damp sponge or a piece of silicon cloth.
- After soldering check (preferably with a magnifying glass) tracks for accidental solder bridges and short circuits. This would cause faulty operation or, in the worst case, permanent damage. You can remove excess solder by putting a clean soldering tip on the spot. The solder will become liquid again and flow from the soldering spot to the soldering tip.

4. Operation overview

4.1. Modes of operation

Digital operation

The function decoder FD-R Extended.2 is a multiple protocol decoder, that can operate with and automatically recognise both DCC or Motorola formats.

The number of addresses is dependant on the format being used:

- Motorola-Format: 255 addresses,
- DCC-Format: 127 Basis-addresses or 10.239 Extended.2 addresses.

In the DCC format the decoder can be driven in all speed levels (14, 28 or 128). In the Motorola format the decoder can be driven in 14 speed levels.

Programming the decoders is done:

- in Motorola format by setting the registers,
- in DCC format by setting the configuration variables (direct programming, DCC conform) or by POM (programming on main = main track programming).

Analogue mode

The decoder can also be used in analogue model railway layouts run with a **D.C.** speed control. When putting the vehicle on the rails the decoder recognizes automatically if it is run in analogue or digital mode and sets the corresponding operation mode. The automatic recognition of the analogue mode can be switched off.

**Caution:**

Old analogue driving transformers (e.g. models in a blue housing from Maerklin**) are not suitable for use with digital decoders in analogue operation! These transformers have been designed for the older supply voltage of 220 V and, due to construction, generate very high excess voltage impulses when changing the driving direction. When using them with the modern supply voltage of 230 V too high excess voltage impulses can occur, damaging electronic parts on the decoder. For that reason only use driving transformers designed for a net voltage of 230 V.

Switching the function outputs on or off is not possible in analogue mode. They can be programmed so that they are either switched on or off in analogue mode. The effects set for the outputs are active in analogue mode as well.

Outputs to be switched with F0 are switched on or off in analogue mode according to the direction of travel with layouts run with a D.C. speed control, provided the return conductor of the lamps or accessories is connected to the decoder's return conductor for all functions.

4.2. Function outputs

The decoder has five function outputs with a maximum current of

- 300 mA each (F0f, F0r, AUX1, AUX2) or
- 500 mA (AUX3).

The decoder's maximum total current is 1.200 mA.

Effects of the function outputs

- Flashing (all outputs). Both the frequency and the keying ratio can be set. Example of use: flash lights or strobe lights.
- Kick function (all outputs). It is possible to set the outputs so that they get the full voltage first for up to 12,5 seconds and then are switched off. Example of use: For some types of electric couplings

you need the full voltage for decoupling and the voltage then switched off to protect the couplings.

- Dimming (not possible for output F0r). Example of use: The electric bulbs of older vehicles made for analogue operation can be dimmed and thus must not be exchanged after the mounting of the decoder.
- Dimming depending on the speed level (not possible for output F0r). The voltage will be dimmed depending on the speed level. This enables weak smoke generation during halts or a switched off or dimmed cab lighting while the train is moving.
- Inverted switching (all outputs): When set to position "on" the assigned function output will be switched off, when set to position "off" switched on.

Function mapping according to RCN-227

Assigning the functions to the outputs follows RailCommunity standard RCN-227. It is possible to assign one or several outputs to each function (F0 to F28, separately for forward and backward motion for each function). In addition, it is possible to assign another function as an "OFF"-switch to the functions.

This mode of function mapping allows to implement special features, e.g.:

- Switching on and off depending on the direction of travel.
- Shunting light: When switching to shunting operation the signals for shunting locomotive are switched on and those for standard operation switched off.
- Switching off the locomotive's taillights when connecting wagons.

4.3. Sound functions

Integrated sounds

Three integrated sounds are available:

- door's snapping when closing,
- door's bleeping when closing,
- train conductor's whistle.

4.4. Servo outputs and switching inputs

The FD-R Extended.2 has two connections to be used optionally as

- two switching inputs or
- two servo outputs (for the transmission of signals operating servos) or
- one switching input and one servo output.

The voltage supply for the servo(s) cannot be provided by the decoder. For that reason an external voltage supply (e.g. servo PCB item-no. 70-05900) is required.

The servo is controlled by:

- setting the end positions via CVs and
- activating the functions ("on" = end position 1, "off" = end position 2).

4.5. Releasing the actions

The function outputs and the integrated sounds can be released by:

- the functions and / or
- automatically via the switching inputs. The switching inputs are released via external contacts, e.g. via reed contacts or Hall sensors in combination with permanent magnets in the rails.

The servo outputs can be triggered by the functions only.

Mapping of the actions to the functions (Function Mapping)

The mapping of the decoder's actions (in other words the function and servo outputs and the integrated sounds) to the functions is arbitrary, separately for forward and backward motion.

Actions	DCC format	MM format
Outputs F0f, For,AUX1 to AUX3	F0 to F28 assignment according to RCN-227	F0 to F4
Servo outputs 1 and 2		
Integrated sounds 1 to 3		

4.6. Feedback with RailCom**

Notes on RailCom®

The function decoder FD-R Extended.2 is a RailCom transmitter and complies with the RailCommunity draft code RCN-217 "RailCom DCC-feedback protocol" (status 18.12.2016) to mobile decoders (vehicle decoders). RCN-217 has been published on:

www.railcommunity.org

RailCom® is a registered trademark of Lenz Elektronik GmbH. In order to increase the readability of this text, we do without referring to this with every use of the term RailCom.

Background information: RailCom-messages of vehicle decoders

On channel 1 vehicle decoders send their address when a DCC-command has been sent to any vehicle decoder. On channel 2 they send their messages after a DCC-command has been sent to their address.

Sending RailCom messages is only possible in layouts with a DCC signal on the rails. It is not possible to use the RailCom-function in a pure Motorola environment.

Background information: Dynamic RailCom information

"Dynamic information" mean contents of CVs (RailComCVs 64-127) which change during operation (e.g. real speed, reception statistics, tank content). If needed, they are sent to the decoder spontaneously.

The reception statistics are kept by the vehicle decoder, and reported as number of faulty data packet in relation to the total number of data packages. These statistics allow conclusions on the transmission quality between vehicle and rails.

The FD-R Extended.2 can send the following dynamic RailCom information:

- reception statistics
- real speed
- actually covered distance

For speed and distance measurement you have to fix an impulse generator (one or max. 4 magnets) at the vehicle's measuring wheel and a measuring sensor (reed contact or Hall sensor) nearby.

For test purposes you can configure output F0r as an impulse display by appropriate CV programming. Every time the magnet(s) fixed to the measuring wheel are detected by the measuring sensor, the lamp or LED connected to F0r is switched on or off. This allows an optical control of the correct working of impulse generator and measuring sensor.

4.7. POM-update

POM-update is a procedure allowing to update the decoder's firmware (= specific decoder software) without dismounting the decoder or using a specific device. POM-update is based upon programming on main (POM) for the DCC format.

Preconditions for using the procedure are:

- Digital central unit with PC interface providing the DCC format and POM. Hint: As nearly every manufacturer of central units uses his own procedure for programming on main, the POM-update can be performed with the following central units only (status 07/2018):

MasterControl (Tams Elektronik)

RedBox (Tams Elektronik)

CS2 (Maerklin**)

The current list of central units allowing to perform the POM-update is available on our homepage.

- PC. The system software must support Java.
- Software "POM-Updater.exe": You will find it on the CD included in delivery. It is also available on our homepage for free download.

You can download the current firmware version of the decoder free of charge from our homepage. If you want to get information on new firmware versions please subscribe to our newsletter on our homepage.

5. Technical specifications

Data format	DCC and MM
Feedback log	RailCom
Supply voltage	12-24 V digital voltage or max. 20 V analogue DC voltage
Current consumption (without connected loads)	max. 40 mA
Max. total current	1 200 mA
Number of function outputs Max. current per output	5 F0f, F0r, AUX1, AUX2: 300 mA AUX3: 500 mA
Output for servo max. current for servo output	max. 2 5 mA
Number of switching inputs	max. 2 Hint: the connections can be used optionally as: 2 servo outputs or 2 switching inputs or 1 servo output and 1 switching input.
Output for loudspeaker Playback Impedance Rated load-carrying capacity	1 mono $\geq 4 \text{ Ohm}$ $\geq 0.1 \text{ Watt}$
Connection for buffer capacitor Capacity Electric strength	1 100 to 470 μF $\geq 25 \text{ V}$

Protected to	IP 00
Ambient temperature in use	0 ... +60 °C
Ambient temperature in storage	-10 ... +80 °C
Comparative humidity allowed	max. 85 %
Dimensions (approx.) - without PluX12 interface - with PluX12 interface	19,5 x 9 x 4,5 mm 19,5 x 9 x 7,5 mm
Gewicht (approx.) - without connecting wires - with soldered connecting wires - with PluX12 interface	1,0 g 3,0 g 1,2 g

6. Connections



Note the following comment in order to protect the decoder from (maybe irreparable) damage!

Avoid all conducting connections between the decoder and accessories connected to the decoder's common return conductor for all function outputs on the one hand and metal parts of the vehicle or the rails on the other hand. Connections result for example from badly isolated connecting wires (as well as at the stripped ends of connecting wires not in use) or insufficient fixing and isolating the decoder or the accessories, for example. Risk of short circuit!

Before connecting the lighting and other accessories to the outputs check if their current is below the maximum permissible value per output and the total current is below the safe load. Should the permissible current be exceeded, this normally results in damage to the decoder.

You should under no circumstances connect the decoder's return conductor for all functions to vehicle ground. Risk of short circuit!

Old analogue driving transformers (e.g. models in a blue housing from Maerklin**) are not suitable for use with digital decoders in analogue operation! These transformers have been designed for the older supply voltage of 220 V and, due to construction, generate very high excess voltage impulses when changing the driving direction. When using them with the modern supply voltage of 230 V too high excess voltage impulses can occur, damaging electronic parts on the decoder. For that reason only use driving transformers designed for a net voltage of 230 V.

6.1. Connector pin assignment

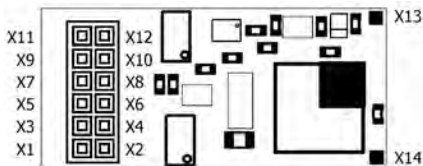

FD-R Extended 2
- Front side -

Front side	Colour of wire	Connection to (for use of settings in state of delivery)	Assigned function (in state of delivery)
X1	white	F0f = lighting forward motion	function F0 forward
X2	orange	Return conductor for AUX3 (+). Not for use as return conductor for other outputs!	
X3	blue	Return conductor for all functions (+)	
X4	grey	AUX3	function F3
X5	---	Index, not occupied	
X6	red	Right current collector (or slider)	
X7	yellow	F0r = lighting backward motion; When programming CV 102 accordingly: impulse display for speed and distance measurement.	function F0 reverse
X8	black	Left current collector (or vehicle ground)	
X9	brown	Loudspeaker connection A (signal / -)	
X10	green	AUX1	function F1
X11	brown	Loudspeaker connection B (+)	

Front side	Colour of wire	Connection to (for use of settings in state of delivery)	Assigned function (in state of delivery)
X12	violet	AUX2	function F2
X13	grey	Servo output 1 or Switching input IN1 or Impulse generator for speed and distance measurement	---
X14	grey	Servo output 2 or switching input IN2	

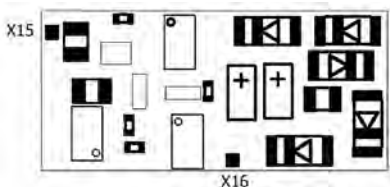
FD-R Extended 2
- Rear side -

Rear side	Colour of wire	Connection to
X15	brown	Negative pole (-) of buffer capacitor Earth connection for reed contacts / Hall sensors or servo
X16	blue	Positive pole (+) of buffer capacitor; Supply voltage for Hall sensors

6.2. Using a FD-R Extended.2 with PluX12-interface connector

Some vehicle manufacturers mount ex works PluX interfaces in carriages with lightings or other accessories. The connection points X2 and X4, normally used with the PluX interface for the motor connection, are not in use in this case. For that reason, you cannot switch output AUX3 of the FD-R Extended.2 in carriages with ex works PluX interface.

Please note: The FD-R Extended.2 is a pure function decoder and not designed to control a motor. Therefore, it cannot be used as a locomotive decoder in locomotives with PluX interface.

	Bezeichnung	Anzahl der Pole	MOROP Norm
	PluX12	11	NEM 658

Using a (function-) decoder with a suitable connector saves separating the connections and soldering works at the vehicle. The interface enables you to connect the decoder to the rail current collectors, the lighting and additional accessories.

The PluX-connectors according to NEM 658 can be mounted in one direction only. You can use a decoder with PluX12 interface connector in a vehicle with PluX16 or PluX22 interface as well. All functions provided by the decoder (except AUX3) are available then.

6.3. Connection to the voltage supply

When connecting the vehicle's current collectors check the right assignment (left/right). When interchanging the connections, the outputs switched depending on the direction of motion will be switched incorrectly in regard to the direction of travel.

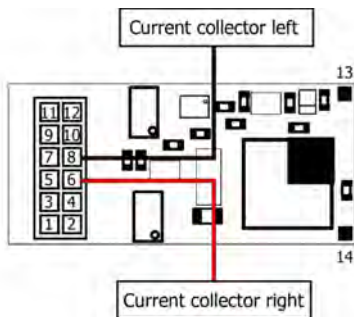

Fig. 1: Connection to the voltage supply

6.4. Connecting accessories to the outputs

Disconnect any existing diodes in the leads to the lamps, otherwise the lamps might not light. Connect the lamps and the accessories to the function outputs of the decoder (F0f, F0r, AUX1 to AUX3).

When you want to use the factory (default) settings of the decoder, check the preceding lists on pages 21 and 22. Otherwise you can assign the outputs to the functions voluntarily by setting the configuration variables. Regard the effect "Dimming" cannot be set for the outputs F0r.

If the lamp or the accessory is already connected with one side to vehicle ground, the connection is complete. If not, connect the second side of the lamp or the accessory to the decoder's return conductor for all functions (point X3). Alternatively, you can use X2 as a return conductor for output AUX3 (but not for the other outputs).

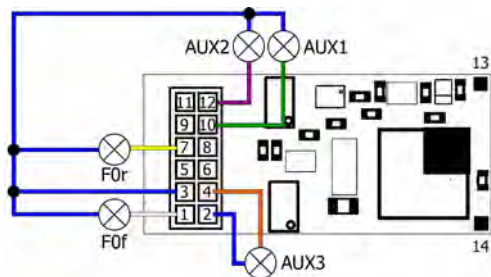

F0f, F0r, AUX1, AUX2	AUX3	max. total current
max. 300 mA each	max. 500 mA	1.200 mA

Fig. 2: Connection of accessories

6.5. Connecting LEDs to the function outputs

The decoder's function outputs switch respective to the decoder ground. For that reason you must connect the cathodes (-) of the LEDs to the function outputs and the anodes (+) to the decoder's common return conductor for all function outputs (X3).



Caution:

If you use light-emitting diodes (LEDs) you must always operate them via a series resistor, otherwise they will be damaged when put into operation or their duration of life will be reduced considerably!

When doing without a series resistor, other components undertake the series resistor's function (e.g. rails, wheels, current connectors), possibly leading to a modification of the data signal and thus to disturbances in digital operation.

Always determine the necessary series resistor's value for the peak value of the available operating voltage. With regulated boosters this corresponds to the specified boosters' output (= track) voltage. With not regulated boosters or analogue driving transformers the peak value is approx. 1,4 fold the nominal voltage specified on the transformer.

Serial connection of LEDs

When you want to connect several LEDs to one output you can switch them in series via a common series resistor. The current consumption is max. 20 mA for all LEDs, depending on the series resistor's value. The maximum number of LEDs to be connected in series results from

Peak value of the operating voltage

- sum of the forward voltages of all LEDs

> 0

The advantage of this solution is the low current consumption.

In order to determine the necessary series resistor for a serial LED's connection first add the forward voltages of all LEDs. The forward voltages depend on the lighting colour and should be given in the technical specifications. In case there is no manufacturer information available, you can take as a basis 4 V for white and blue LEDs and 2 V for yellow, orange, red and green LEDs.

The remaining voltage has to be "eliminated" by a resistor. The formula for the calculation of the resistor is:

$$\text{required } R_V [\text{Ohm}] = (U_B [\text{V}] - \sum U_F [\text{V}]) / (I_F [\text{mA}] \times 0.001)$$

U_B = operating voltage (peak value) | $\sum U_F$ = sum of the forward voltages of all LEDs

I_F = current with max. luminosity

Parallel connection of LEDs

Alternatively, you can connect several LEDs in parallel, each via a series resistor of its own. The current consumption is max. 20 mA for all LEDs, depending on the series resistor's value. The maximum number of LEDs to be connected in parallel results from

maximum current at the output

- sum of the current consumption of all LEDs

> 0

Advantageous with this solution is that the LEDs already lighten when their forward voltage has been reached (2 to 4 V, depending on the fluorescent colour), which makes this solution suitable for analogue mode. Disadvantageous is the high current consumption.

The formula for the calculation of the resistor is:

$$\text{required } R_V [\text{Ohm}] = (U_B [\text{V}] - U_F [\text{V}]) / (I_F [\text{mA}] \times 0.001)$$

U_B = operating voltage (peak value) | U_F = forward voltage of the LED

I_F = current with max. luminosity

In order to save current, you can limit the LEDs' current consumption to 10 mA, which normally does not cause a visible loss of luminance.

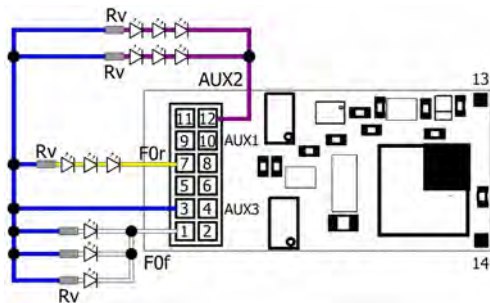

F0f, F0r, AUX1, AUX2	AUX3	max. total current
max. 300 mA each	max. 500 mA	1.200 mA

Fig. 3: Connection of LEDs (examples)

F0f: parallel connection

F0r: serial connection

AUX2: combination of parallel and serial connection

Rv: series resistor

6.6. Connecting inductive loads

When connecting inductive loads (e.g. TELEX couplings, relays or other accessories with coils), you should switch a free-wheeling diode (e.g. 1N400x) in parallel, in order to avoid damage at the output. Check to connect the anode (+) to the function output.

6.7. Connecting accessories via a relay

When you want to switch an accessory / accessories via the decoder, which connection would lead to exceeding the maximum current at the output or of the decoder, you can switch the accessories via a monostable relay (e.g. 1xUm 1A 12V, item no. 84-61010).

The current consumed by the relay depends on its type. The relay named in the example needs approx. 100 mA.

As described in the section "Connecting inductive loads" you should switch a free-wheeling diode (e.g. 1N400x) in parallel to the relay.

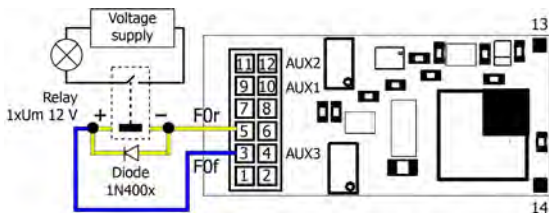

Fig. 4: Connection of an accessory via a relay

6.8. Connecting a loudspeaker

Use a loudspeaker with an impedance of at least 4 Ohm. When connecting a loudspeaker with a lower impedance, the output for the loudspeaker will be damaged. As a rule the playback quality increases with the loudspeaker's size. For that reason you should choose a loudspeaker as large as possible.

In addition, the correct mounting of the loudspeaker is decisive for the sound reproduction. The loudspeaker membrane should emit directly to the outside, the other side into the inside of the vehicle which should be as airtight as possible. The larger the volume in the inside, the better is the reproduction quality. Suitable for the mounting are e.g. the bottom of the vehicle or the back of the driver's cab.

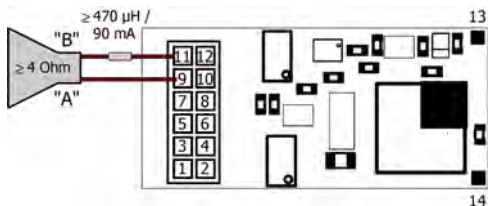

Fig. 5: Connection of a loudspeaker

As a matter of principle the sound playback can be distorted or disturbed by a high whistling noise. For that purpose you should solder a suppression choke ($\geq 470 \mu\text{H} / 90 \text{ mA}$) into one of the supply wires of the loudspeaker.

Hint: When using sound functions, it is generally recommended to connect a buffer capacitor (see section 6.8.).

6.9. Connecting a buffer capacitor

In sections with bad contact to the rails the power supply of the decoder can be interrupted. Possible consequences are e.g. flickering lighting or disturbing noises from the loudspeaker. In these and similar cases you can find a remedy by connecting a buffer capacitor.

It is generally recommended to connect a buffer capacitor for the following applications:

- sound functions
- controlling servos
- distance measurement

The minimum capacity depends on the application of the decoder:

without sound or controlling servos	with sound or controlling servos	with impulse generator for distance measurement
min. 100 μF / 25 V	min. 220 μF / 25 V	min. 470 μF / 25 V

! Observe the correct polarity when connecting the capacitor!

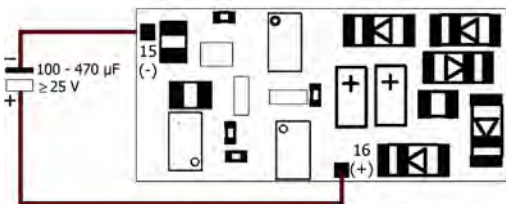

Fig. 6: Connection of a buffer capacitor $\leq 470\ \mu\text{F}$
(rear side of the decoder)

Connecting a buffer capacitor > 470 μF

When using a buffer capacitor with a capacity exceeding 470 μF , you need a charging circuit, consisting of

- resistor 100 Ohm
- free wheeling diode 1N400x, $x \geq 2$

On the one hand, this ensures a slow charging of the capacitor (and prevents a voltage drop due to charging the capacitor when switched on) and on the other hand, it quickly provides the required voltage in case of need.

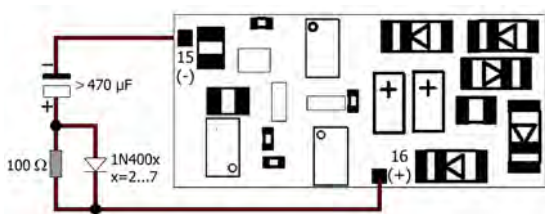

Fig. 7: Connection of a buffer capacitor > 470 μF via a charging circuit

6.10. Connecting a servo

Connect the signal input of the servo to connecting point X13 and/or X14 and the earth connection of the servo to point X15 of the decoder. The voltage supply for the servo should not be taken from the decoder, as the decoder cannot supply the current needed to control the servo. For that reason you need an external voltage supply for the servo (e.g. servo PCB item no. 70-05900).

Please note: You have to assign at least one function to the servo(s) in function mapping.

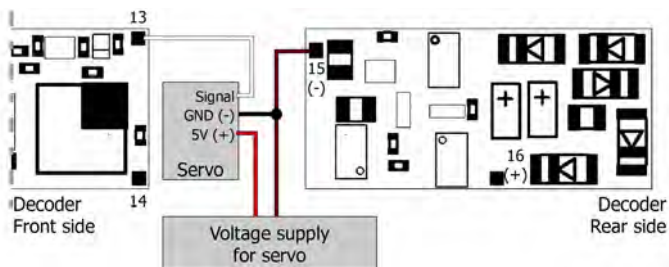

Fig. 8: Connection of a servo to X13

Hint: When controlling a servo, it is generally recommended to connect a buffer capacitor (see section 6.8.).

Hint: When using a servo PCB (item no. 70-05900) as a voltage supply for the servo, it is recommended to connect the voltage supply for the PCB in parallel to the buffer capacitor to the decoder (X15 and X16), instead of connecting it to the current collectors.

6.11. Connecting the switching inputs

The switching inputs switch respective to the decoder ground and thus can be connected to all (external) circuits allowing to make contact to earth. It is possible to connect reed contacts or Hall sensors, for example, which make contact to earth when getting into the magnetic field of a permanent magnet.

Connect the reed contacts to the switching inputs (X13 and/or X14) and the earth connection (X15). Reed contacts are not polarized, you can assign the two contacts voluntarily.

When connecting Hall sensors check for the correct polarity. Connect the earth connection of the Hall sensor to X15, the connection for the voltage supply to X16 and the output to one of the switching inputs (X13 or X14).



Attention:

When exchanging the earth connection for the connection of the voltage supply, the Hall sensor can be damaged!

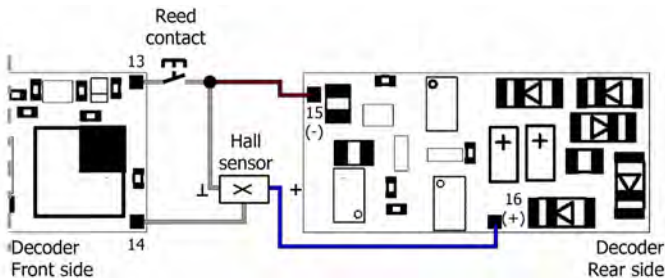

Fig. 9: Connection of a reed contact (X13) and a Hall sensor (X14) to the switching inputs

6.12. Connecting an impulse generator

For speed and distance measurement you have to fix an impulse generator (one or max. 4 magnets) at the vehicle's measuring wheel and a measuring sensor (reed contact or Hall sensor) at the vehicle's underbody. Connect the reed contact or the Hall sensor according to section 6.10. (Connecting the switching inputs) to X13 (not to X14).

Hint: When using an impulse generator for distance measurement, it is generally recommended to connect a buffer capacitor (see section 6.8.).

You can use X14 for the connection of a servo or a reed contact or a Hall sensor for use as switching input.

6.13. Fixing the decoder

After having finished all connections you should fix the decoder (except version with PluX interface), to avoid short circuits by contact to metal parts of the vehicle, for example. You can use double sided adhesive tape for it or a decoder holder (item no. 70-01810 or 70-01820), for example.

7. Programming

Programming with DCC central units

You can program the configuration variables (CV) of the decoder from the digital central unit, you can use main track programming as well. See the chapter in the manual of your central unit where the byte wise programming of configuration variables (CVs) (Direct programming) and main track programming (POM) are explained. With central units that allow only register-programming it is not possible to program the FD-R Extended.2.

Please note: It is not necessary to connect an accessory to one of the outputs before starting programming the decoder.

Programming with Motorola central units

In Motorola format the settings are saved in registers.

Hint: With pure Motorola central units it is not possible to use the function mapping. For this you need a DCC central unit. If you do not have a DCC central unit at hand and if you do not want to use the default values, you can send in the decoder for (free of charge) programming (address see last page).

Please note: If you use a central unit for both DCC and Motorola format it is recommended to program the decoder in the DCC format. After having finished programming the decoder it is possible to control it in Motorola format as well.

Please note: You should connect a lamp or a LED to at least F0f or F0r before starting to program the decoder with a Motorola central unit, as the decoder shows the status of the programming by flashing the lighting connected to these outputs. The flashing frequency shows, which input the decoder expects:

Slow flashing	Fast flashing
---------------	---------------

Number of the register to be programmed	Value of the register to be programmed
--	---

Put the vehicle on a track oval or a track section connected to the central unit's track output (not to the connection for the programming track). Make sure no other vehicle than the one you intend to program is set on the track as the decoder inside this vehicle might be programmed as well.

Starting the programming mode	Programming the decoder
<ol style="list-style-type: none"> 1. Switch on the central unit or perform a reset at the central unit (pushing "stop" and "go" simultaneously). 2. Set the current decoder address (default value: 3) or the address "80". 3. Set all functions to "off". 4. Push button "stop" → switch off the track voltage. 5. Operate the direction switch and hold it in that position. Push the button "go" at once. 6. As soon as the lighting flashes, release the direction switch. 	<ol style="list-style-type: none"> 1. Enter the number of the register as a Motorola-address. If necessary: with a leading "0". 2. Operate the direction switch. → Lighting flashes faster. 3. Enter the value you want to set into the register (as Motorola-address). 4. Operate the direction switch. → Lighting flashes more slowly. <p>Repeat steps 1 – 4 for all registers.</p> <p>Push button "stop".</p>
→ Programming mode	→ End of programming mode.

Programming with the Central Station and the Mobile Station

With the Central Station I or the Mobile Station of Maerklin** you can program the registers. Select the article no. 29750 from the locomotive database and program the decoder as described for this article in the Central Station´s or Mobile Station´s manual.

Programming with the CV-Navi

Instead of programming the configuration variables or registers of the decoder using the digital central unit, you can use the free software CV-Navi. You will find the free download under:

www.tams-online.de

A central unit RedBox or Master Control is required for using the software.

8. Configuration variables and registers

In the lists you will find in the column "No." the numbers of the configuration variables for programming in DCC format. The numbers of the registers for programming in Motorola format are identical to the CV numbers. The defaults are those values set in the state of delivery and after a reset.

Please note: With variables destined to set several parameters, the input value has to be calculated by adding the numerical values assigned to the desired parameters.

8.1. Setting the address

Name of CVs / registers	No.	Input value (Default)	Remarks and Tips
Basic address	1	1 ... 255 (3)	Range of values in DCC-Format: 1 ... 127
Tip: If a value higher than 127 is set for the basic address and the use of Extended.2 addresses in CV 29 is set to off, the decoder does not react to signals in DCC format!			
Name of CVs	No.	Input value (Default)	Remarks and Tips
Extended.2 address	17	192 ... 255 (192)	In DCC format only! Most central units permit entering Extended.2 addresses directly. The CVs 17, 18 and 29 are set automatically to the proper values.
	18	0 ... 255 (255)	
Consist address	19	1 ... 127 (0)	In DCC format only! = Address for multiple units

8.2. Information (Readable in DCC format only!)

Name of CVs	No.	Input value (Default)	Remarks and Tips
Version	7	---	Readable in DCC format only!
Manufacturer	8	--- (62)	Readable in DCC format only!
Permitted modes of operation	12	--- (37)	Readable in DCC format only! Defines the permitted modes of operation for the decoder 37 = DC (1) + DCC (4) + MM (32)
Method for assigning the functions	96	--- (2)	Readable in DCC format only! Defines the method for assigning the functions: using CV 257 to 512 using CV for each function according to RCN 227

8.3. Auxiliary functions

Name of CVs / registers	No.	Input value (Default)	Remarks and Tips
Reset	8	0 ... 255	Any input value restores the settings in state of delivery.
Decoder lock	15	0 ... 255 (3)	Allows to alter the CVs seperately for each decoder when using several decoders with the same basic (CV 1) or extended address (CV 17 and CV 18) in one vehicle.
	16	0 ... 255 (3)	
<p>Example of use: Before mounting, an individual value is set for each decoder in CV 16, e.g. "1" for motor decoders, "2" for sound decoders, "3" or higher for other types of decoders. Hint: The value "0" has been allocated to "all locked".</p> <p>In order to alter or read the CVs of one of the mounted decoders, you have to enter the value of CV 16 into CV 15. The decoders compare the values of CV 15 and 16 and only in case both values match, access to the CVs will be enabled.</p>			
Name of CVs	No.	Input value (Default)	Remarks and Tips
Index for higher CV-Pages	31	0 (0)	Adjustable in DCC format only! Function mapping 0 RailCom 0
	32	42, 255 (42)	Adjustable in DCC format only! Function mapping 42 RailCom 255

8.4. Basic settings

In general

Name of CVs / registers	No.	Input value (Default)	Remarks and Tips
Configuration data 1	29	0 ... 255 (14)	Direction "Standard" 0
			Reverse direction 1
			14 speed levels 0
			For DCC format only! 28 or 128 speed levels 2
			Analoge recognition off 0
			Analoge recognition on 4
			RailCom off 0
			RailCom on 8
			Basic addresses 0
			For DCC format only! Extended addresses 32
<p>Example: CV 29 = 0. → Direction = "Standard". 14 speed levels. Basic addresses. Automatic analogue recognition = "off". RailCom = "off".</p> <p>Example: CV 29 = 46. → Direction = "Standard". 28 or 128 speed levels in DCC-mode. Automatic analogue recognition = "on". RailCom = "on". Extended.2 addresses.</p> <p>Tip: If the use of Extended.2 addresses is activated in CV 29, the decoder does not react to signals in Motorola format!</p>			

Settings for analogue mode

Name of CVs / registers	No.	Input value (Default)	Remarks and Tips
Packet time out for analogue recognition	11	0 ... 255 (5)	The higher the set value, the longer it takes until the decoder automatically switches to analogue mode after having received the last digital signal. Increasing the input value by "1" extends the time period by 10 ms.
Functions active in analogue mode (F1 to F8)	13	0 ... 255 (0)	F1 on 1
			F2 on 2
			F3 on 4
			F4 on 8
			F5 on 16
			F6 on 32
			F7 on 64
			F8 on 128
Functions active in analogue mode (F0, F9 to F12)	14	0 ... 255 (0)	F0f on 1
			F0r on 2
			F9 on 4
			F10 on 8
			F11 on 16
			F12 on 32

Controlling functions in multiple units (Consist operation)

As a standard, in consist operation you can only control velocity and direction. In CV 21 and 22 you can define additional functions to be switched when using the address for multiple units defined in CV 19. The value "0" means that the function can be switched only when using the vehicle address set in CV 1 or CV 17 / 18.

Name of CVs / registers	No.	Input value (Default)	Remarks and Tips
Functions active in consist operation (F1 to F8)	21	0 ... 255 (0)	F1 on 1
			F2 on 2
			F3 on 4
			F4 on 8
			F5 on 16
			F6 on 32
			F7 on 64
			F8 on 128
Functions active in consist operation (F0, F9 to F12)	22	0 ... 255 (0)	F0f on 1
			F0r on 2
			F9 on 4
			F10 on 8
			F11 on 16
			F12 on 32

Settings for RailCom

Name of CVs / registers	No.	Input value (Default)	Remarks and Tips
Dynamic RailCom information	10	0,1,2,3,4 (0)	0 = off 1 = Reception statistics: The decoder keeps statistics on all DCC packets and reports the number of faulty packets / total number of packets in %. 2 = Real speed. The speed is reported in km/h. 4 = Distance measurement: actually covered distance in mm.
<p>In order to read out RailCom information, you have to make the following additional settings:</p> <ul style="list-style-type: none"> - RailCom on (CV 29) - RailCom settings: channel 2 or channel 1 and 2 on (CV 28) <p>For measuring speed and distance you have to install an impulse generator and to make settings in CV 101 to 104.</p> <p>Hint: When choosing "Distance measurement", you have to switch off "Reception statistics" and "Real speed".</p>			
RailCom settings	28	0,1,2,3,4,5,6,7 (3)	0 = no feedback 1 = channel 1 on only 2 = channel 2 on only 3 = channel 1 and 2 on 4 = dynamic channel 1 use (address report on channel 1 restricted)

Name of CVs / registers	No.	Input value (Default)	Remarks and Tips
Layout scale	101	22, 32, 43, 87, 120, 160, 220 (87)	Nominal size
			Z 220
			N 160
			TT 120
			H0 87
			0 43
			I 32
			II 22
Measuring wheel / Number or magnets	102	0, 1, 2, 3, 4, 129, 130 ,131, 132 (0)	For testing purposes you can configure F0r as an impulse display (all other functions can be used as normal). As soon as the measuring sensor detects a magnet, the output switched by F0r will be switched on or off.
			1 magnet 1
			2 magnets 2
			3 magnets 3
			4 magnets 4
			Test function on 128
Wheel diameter	103		Pre-decimal digits
	104		Decimal digits
<p>The wheel diameter has to be entered in mm. Example: wheel diameter = 11,4 mm: CV 103 = 11 and CV 104 = 4.</p>			

8.5. Use of X13 and X14

You can use the connections X13 and X14 optionally as

- two switching inputs to switch the outputs and the integrated sound functions or
- two servo outputs or
- one switching input and one servo output

Please note: If you want to control servos, they have to be assigned to at least one function (see section 8.6. "Function Mapping").

Name of CVs / registers	No.	Input value (Default)	Remarks and Tips
Use as servo outputs			
X13	62	0 (0)	Servo signal 0
X14	64	0 (0)	Hint: in order to activate the signal output, you have to assign a function to the servo output (CV 259 ff).
or: Use as switching inputs			Assignment to the outputs:
X13	62	1 ... 255 (0)	F0f 1
X14	64	1 ... 255 (0)	F0r 2
Hint: As soon as assigning a function to a servo in function mapping, the settings made in CV 62 and 64 will be ignored.			AUX1 4
			AUX2 8
			AUX3 16
			Sound 1 (door's snapping) 32
			Sound 2 (door's bleeping) 64
			Sound 3 (conductor's whistle) 128

Setting the minimum on-time of the switching inputs

Name of CVs / registers	No.	Input value (Default)	Remarks and Tips
IN1	97	0 ... 255 (0)	= Length of time for the input to be switched on after having been connected to earth. Increasing the value by "1" will prolong the length of time by 0,1 sec. 0 = 0 sec. (off) 255 = 25.5 sec.
IN2	98	0 ... 255 (0)	

Setting the servo

Name of CVs / registers	No.	Input value (Default)	Remarks and Tips		
Left stop Servo 1 / 2	121	40...250 (112)		Value for stop	
	125			left < right	left > right
Right stop Servo 1 / 2	122	40...250 (176)	F on	→ right	→ left
	126		F off	→ left	→ right
Velocity Servo 1 / 2	123	0 ... 255 (16)	0 = highest velocity		
	127		255 = lowest velocity		
Servo configuration Servo 1 / 2	124	0, 1 (0)	0 = signal switched off after reaching the position		
	128		1 = signal remains switched on		

8.6. Function mapping

Assigning the actions (in other words the function and servo outputs and the integrated sounds) to the functions follows RailCommunity standard RCN-227.

Please note: With pure Motorola central units it is not possible to use the function mapping.

In order to get access to the relevant memory area (the so-called "page"), you have to set in CV 31 and 32 the values for "Function mapping".

Name of CVs	No.	Input value (Default)	Remarks and Tips
Index for higher pages	31	0 ... 255 (0)	Function mapping 0
	32	0 ... 255 (42)	Function mapping 42

There are eight configuration variables (CVs) assigned to each function (F0 bis F28), always four for forward ("**f**") and backward ("**r**") motion:

- 2 CVs for outputs (F0f, F0r, AUX1 to AUX3): They are used to define the outputs switched with the function.
- 2 CVs for sound functions 1 to 3: They are used to define which of the integrated sounds has to be switched with the function:
 - Sound 1: door's snapping when closing,
 - Sound 2: door's bleeping when closing,
 - Sound 3: train conductor's whistle.
- 2 CVs for servo outputs 1 and 2: They are used to define the servo outputs switched with the function.
- Off-funktion: You can define a function which switches **off** the assigned functions when switched **on**. Hint: the assigned functions are generally switched **off**. It is of no importance if they have been switched on or off before.

	Outputs					Sounds			Servos		off/on with function
	F0f	F0r	1	2	3	1	2	3	1	2	
Value	1	2	4	8	16	1	2	4	1	2	F0, F1, F2, ..., F28
Input values	0, 1, 2, 3, 4,..., 31					0, 1, 2, 3			0, 1, 2		0, 1, 2,... 28

CV name	Outputs		Sounds		Servos		off/on with function	
	CV-No.	Default value	CV-No.	Default value	CV-No.	Default value	CV-No.	Default value
F0 f	257	(1) F0f on while moving forward	258	(0)	259	(0)	260	(255)
F0 r	261	(2) F0r on while moving backward	262	(0)	263	(0)	264	(255)
F1 f	265	(4) AUX1 on while moving forward	266	(0)	267	(0)	268	(255)
F1 r	269	(4) AUX1 on while moving backward	270	(0)	271	(0)	272	(255)
F2f	273	(8) AUX2 on while moving forward	274	(0)	275	(0)	276	(255)
F2 r	277	(8) AUX2 on while moving backward	278	(0)	279	(0)	280	(255)
F3 f	281	(16) AUX3 on while moving forward	282	(0)	283	(0)	284	(255)
F3 r	285	(16) AUX3 on while moving backward	286	(0)	287	(0)	288	(255)

	Outputs					Sounds			Servos		off/on with function
	F0f	F0r	1	2	3	1	2	3	1	2	
Value	1	2	4	8	16	1	2	4	1	2	F0, F1, F2, ..., F28
Input values	0, 1, 2, 3, 4,..., 31					0, 1, 2, 3			0, 1, 2		0, 1, 2,... 28

CV name	Outputs		Sounds		Servos		off/on with function	
	CV-No.	Default value	CV-No.	Default value	CV-No.	Default value	CV-No.	Default value
F4 f	289	(0)	290	(0)	291	(0)	292	(255)
F4 r	293	(0)	294	(0)	295	(0)	296	(255)
F5 f	297	(0)	298	(1) Sound 1 on while moving forward	299	(0)	300	(255)
F5 r	301	(0)	302	(1) Sound 1 on while moving backward	303	(0)	304	(255)
F6 f	305	(0)	306	(2) Sound 2 on while moving forward	307	(0)	308	(255)
F6 r	309	(0)	310	(2) Sound 2 on while moving backward	311	(0)	312	(255)
F7 f	313	(0)	314	(4) Sound 3 on while moving forward	315	(0)	316	(255)
F7 r	317	(0)	318	(4) Sound 3 on while moving backward	319	(0)	320	(255)
F8 f	321	(0)	322	(0)	323	(0)	324	(255)
F8 r	325	(0)	326	(0)	327	(0)	328	(255)

	Outputs					Sounds			Servos		off/on with function
	F0f	F0r	1	2	3	1	2	3	1	2	
Value	1	2	4	8	16	1	2	4	1	2	F0, F1, F2, ..., F28
Input values	0, 1, 2, 3, 4,..., 31					0, 1, 2, 3			0, 1, 2		0, 1, 2,... 28

CV name	Outputs		Sounds		Servos		off/on with function	
	CV-No.	Default value	CV-No.	Default value	CV-No.	Default value	CV-No.	Default value
F9 f	329	(0)	330	(0)	331	(0)	332	(255)
F9 r	333	(0)	334	(0)	335	(0)	336	(255)
F10 f	337	(0)	338	(0)	339	(0)	340	(255)
F10 r	341	(0)	342	(0)	343	(0)	344	(255)
F11 f	345	(0)	346	(0)	347	(0)	348	(255)
F11 r	349	(0)	350	(0)	351	(0)	352	(255)
F12f	353	(0)	354	(0)	355	(0)	356	(255)
F12 r	357	(0)	358	(0)	359	(0)	360	(255)
F13 f	361	(0)	362	(0)	363	(0)	364	(255)
F13 r	365	(0)	366	(0)	367	(0)	368	(255)
F14 f	369	(0)	370	(0)	371	(0)	372	(255)
F14 r	373	(0)	374	(0)	375	(0)	376	(255)
F15 f	377	(0)	378	(0)	379	(0)	380	(255)
F15 r	381	(0)	382	(0)	383	(0)	384	(255)
F16 f	385	(0)	386	(0)	387	(0)	388	(255)
F16 r	389	(0)	390	(0)	391	(0)	392	(255)

	Outputs					Sounds			Servos		off/on with function
	F0f	F0r	1	2	3	1	2	3	1	2	
Value	1	2	4	8	16	1	2	4	1	2	F0, F1, F2, ..., F28
Input values	0, 1, 2, 3, 4,..., 31					0, 1, 2, 3			0, 1, 2		0, 1, 2,... 28

CV name	Outputs		Sounds		Servos		off/on with function	
	CV-No.	Default value	CV-No.	Default value	CV-No.	Default value	CV-No.	Default value
F17 f	393	(0)	394	(0)	395	(0)	396	(255)
F17 r	397	(0)	398	(0)	399	(0)	400	(255)
F18 f	401	(0)	402	(0)	403	(0)	404	(255)
F18 r	405	(0)	406	(0)	407	(0)	408	(255)
F19 f	409	(0)	410	(0)	411	(0)	412	(255)
F19 r	413	(0)	414	(0)	415	(0)	416	(255)
F20 f	417	(0)	418	(0)	419	(0)	420	(255)
F20 r	421	(0)	422	(0)	423	(0)	424	(255)
F21 f	425	(0)	426	(0)	427	(0)	428	(255)
F21 r	429	(0)	430	(0)	431	(0)	432	(255)
F22f	433	(0)	434	(0)	435	(0)	436	(255)
F22 r	437	(0)	438	(0)	439	(0)	440	(255)
F23 f	441	(0)	442	(0)	443	(0)	444	(255)
F23 r	445	(0)	446	(0)	447	(0)	448	(255)
F24 f	449	(0)	450	(0)	451	(0)	452	(255)
F24 r	453	(0)	454	(0)	455	(0)	456	(255)

	Outputs					Sounds			Servos		off/on with function
	F0f	F0r	1	2	3	1	2	3	1	2	
Value	1	2	4	8	16	1	2	4	1	2	F0, F1, F2, ..., F28
Input values	0, 1, 2, 3, 4,..., 31					0, 1, 2, 3			0, 1, 2		0, 1, 2,... 28

CV name	Outputs		Sounds		Servos		off/on with function	
	CV-No.	Default value	CV-No.	Default value	CV-No.	Default value	CV-No.	Default value
F25 f	457	(0)	458	(0)	459	(0)	460	(255)
F25 r	461	(0)	462	(0)	463	(0)	464	(255)
F26 f	465	(0)	466	(0)	467	(0)	468	(255)
F26 r	469	(0)	470	(0)	471	(0)	472	(255)
F27 f	473	(0)	474	(0)	475	(0)	476	(255)
F27 r	477	(0)	478	(0)	479	(0)	480	(255)
F28 f	481	(0)	482	(0)	483	(0)	484	(255)
F28 r	485	(0)	486	(0)	487	(0)	488	(255)

Example: Programming for shunting operation für Rangierbetrieb

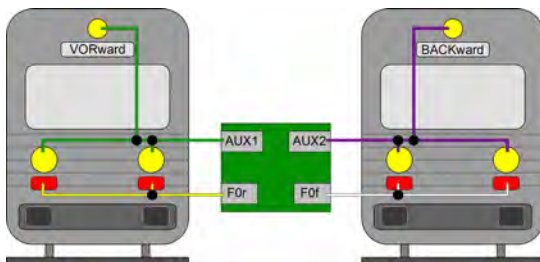

Hint: The connection of the return conductor is not shown.

	Outputs					off/on with function
	F0f	F0r	1	2	3	
Values	1	2	4	8	16	1...254
CV name	CV-No.	Set value			CV-No.	Set value
F0 f	257	5 (outputs F0f and AUX1)			260	3 (F3=shunting operation)
F0 r	261	10 (outputs F0r and AUX2)			264	3 (F3=shunting operation)
F3 f	265	12 (outputs AUX1 and AUX2)			268	(255 = off)
F3 r	269	12 (outputs AUX1 and AUX2)			272	(255 = off)

With this programming you achieve the following effects when changing to shunting operation (here using function F3):

- the rear end signal for the active direction of motion will be switched off and
- the three-light head end signal will be switched on on both sides.

Example: Programming for rear end signal "off" with coupled carriages

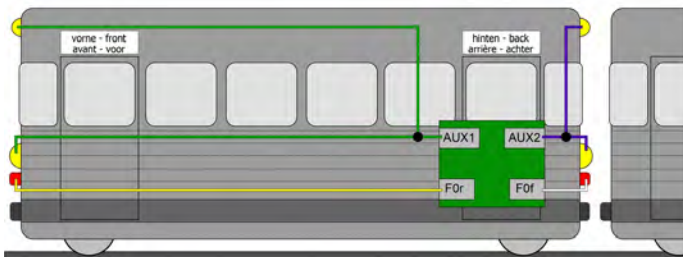

Hint: The connection of the return conductor is not shown.

	Outputs					off/on with function
	F0f	F0r	1	2	3	
Values	1	2	4	8	16	1...254
CV name	CV-No.	Set value			CV-No.	Set value
F0 f	257	5 (outputs F0f and AUX1)			260	5 (F5=coupled carriage)
F0 r	261	10 (outputs F0r and AUX2)			264	5 (F5=coupled carriage)
F5 f	297	4 (output AUX1)			268	(255 = off)
F5 r	301	2 (output F0r)			272	(255 = off)

With this programming you achieve the following effects when changing to operation with coupled carriages (here using function F5):

- the signals appropriate for the direction of motion will be switched on and
- the signals on the side of the coupled carriages will be switched off.

8.7. Effects of the outputs

Name of CVs / registers	No.	Input value (Default)	Remarks and Tips
F0f	57	0 ... 255 (0)	Function inverted 4
F0r	58	0 ... 255 (0)	Flashing inverted 8
AUX1	59	0 ... 255 (0)	Flashing on 16
AUX2	60	0 ... 255 (0)	Kick function on 128
AUX3	61	0 ... 255 (0)	

Example:

Alternating flashing with AUX2 and AUX3:

→ Input value for AUX2: CV 60 = 16 | Input value for AUX3: CV 61 = 24 (16 + 8)

Kick function

Name of CVs / registers	No.	Input value (Default)	Remarks and Tips
Kicking time for direction "forward"	99	0 ... 255 (32)	0 = short 255 = long
Kicking time for direction "backward"	100		

Settings for the flash lights

Name of CVs / registers	No.	Input value (Default)	Remarks and Tips
Flashing frequency of the lighting			
F0f	109	10 ... 255 (20)	Determines the duration of one period. 10 = highest possible frequency 255 = lowest possible frequency
F0r	110		
AUX1	111		
AUX2	112		
AUX3	113		
On-time of the flashlights			
F0f	114	0 ... 255 (4)	The maximum value of the on-time is the value set in CV 109 et seq. The higher the input value, the longer is the on-time.
F0r	115		
AUX1	116		
AUX2	117		
AUX3	118		
<p>Example: For F0f is set in CV 109 a value of 100 for the flashing frequency and in CV 114 a value of 60 for the on-time.</p> <p>With a value of 50 in CV 114 on- and off-time would have the same length, with a value of 100 the light would be switched on permanently.</p>			

Dimming of the outputs

Name of CVs / registers	No.	Input value (Default)	Remarks and Tips
F0f	47	1...255 (255)	= Reduction of the voltage applied to the output. "1" = lowest voltage, "255" = maximum voltage
AUX1	48		
AUX2	49		
AUX3	50		

Dimming of the outputs depending on the speed level

Name of CVs / registers	No.	Input value (Default)	Remarks and Tips
Internal speed level for CV 56	55	1 ... 255 (10)	= speed level, from which the outputs defined in CV 56 are dimmed with the settings in CV 51 to 54 (instead of settings in CV 47 to 50).
Outputs dimmed depending on the speed level	56	0 ... 15 (0)	F0f 1
			AUX1 2
			AUX2 4
			AUX3 8
Dimming depending on the speed level			= reduction of the voltage at the output
F0f	51	1...255 (255)	"1" = lowest voltage
AUX1	52		"255" = maximum voltage
AUX2	53		Values are applied to the outputs determined in CV 55 and starting from a speed level determined in CV 56 only.
AUX3	54		

9. Performing a POM-Update

Preparations

1. In order to perform the firmware update you do **not** have to dismount the decoder. Put the vehicle with the mounted decoder on the main track. Hint: You can perform a firmware update with several decoders FD-R Extended.2 at once, the current software version of the decoders is of no importance. The individual CV settings of the decoder will not be altered by updating.
2. Save the file with the newest firmware on your PC, e.g. FD-R_Extended.2_V2_1_0_0.hex for version 2.1.0.0
You can download the newest firmware from our homepage without charge. When getting (on the part of any third parties) a packed file (e.g. *.zip) you have to unpack it first.
3. Get ready the CD with the program "POM-Updater.exe" (included in the delivery) or download the program from our homepage.
4. Connect your central unit with the PC. At present (status: 07/2018) the POM-Update can be carried out with the MasterControl (Tams Elektronik), the RedBox (Tams Elektronik) and the CS2 (Maerklin**). You find the current list of central units allowing to perform the POM-update on our homepage.
5. Before starting the update connect at least one lamp or LED to AUX2 (F0r) as the update's status is shown by lighting or flashing of the lighting connected to this output.

Changing into the update mode

Execute the programm POM-update.exe, follow the helpfile. Proceed as follows:

1. Make the settings for the update.
2. Enter the addresses of the function decoders FD-R Extended.2 you want to update.
3. Change into the update mode.

The lighting connected to the outputs AUX2 (F0r) of the decoders which are chosen for an update start to flash slowly. If flashing quickly, the decoder cannot be updated

- because the decoder type does not correspond to the hex-file or
- because the decoder´s firmware already conforms to the version of the hex-file.

The concerned vehicles can stay on the track, they do not affect updating the other decoders. As an alternative you can cut them from current shortly in order to stop them flashing quickly.

Performing the POM-Update

After having changed into the update mode you can start the update. The lighting connected to the outputs AUX2 of the decoders in update mode stop to flash and show permanent lighting.

The duration of the update depends on the central unit in use and the extent of the transferred data. The progress is shown in the screen mask. As soon as the update has been finished the lighting start to flash slowly. Cut the vehicles from current shortly. Now the vehicles are in standard operation again.

When a fault occurs during updating, the update is interrupted and the lighting starts to flash quickly. In this case restart the update after altering the settings if necessary (see helpfile of the programm for further information).

10. Check list for troubleshooting

- Parts are getting very hot and/or start to smoke.



Disconnect the system from the mains immediately!

Possible cause: one or more connections are soldered incorrectly.
→ Check the connections.

Possible cause: Short circuit. The decoder is connected to locomotive or carriage ground. → Check the connections. A short circuit can result in irreparable damage.

Problems with switching of the functions

- After programming, the decoder does not react as desired.
Possible cause: The input values for the CVs are incoherent.
→ Perform a decoder reset and first test the decoder with the default values. Programm the decoder anew afterwards.
- An accessory / a light does not react to switching commands.
Possible cause: The accessory is defective or incorrectly connected.
→ Check the accessory / the connections.
Possible cause: The output is defective (e.g. due to overload or short circuit). → Send in the decoder for check / repair (with costs).
- The lighting does not correspond to the direction of motion.
Possible cause: The configuration data (CV29) of the locomotive decoder in the block train are programmed in a different way from the function decoder. → Alter the parameters of the locomotive or the function decoder.
Possible cause: A wrong function (or direction) has been assigned to an output in function mapping. → Check the settings.
- The lighting goes on and off when the speed levels are turned up or the lighting cannot be switched on or off.
Possible cause: The speed mode of the decoder and the digital control

unit do not correspond. Example: The central is set to the mode 28 speed levels, but the decoder to the mode 14 speed levels. → Change the speed mode at the central and / or at the decoder.

Problems in analogue mode

- The decoder does not work in analogue mode.

Possible cause: The analogue mode is switched off. → Alter the value for CV 29.

- The decoder does not switch to analogue mode (or switches over although it is still digitally controlled).

Possible cause: The value in CV 11 is set too high or too low. → Alter the value and check the settings in operation.

Problems with switching via switching inputs

- After passing a permanent magnet in the rails no action is activated.

Possible cause: The reed contact or the Hall sensor has been mounted incorrectly. → Check the connections.

Possible cause: The distance to the magnet is too large or the magnet is too weak. → Alter the position of the magnet (if possible) or use a stronger one.

Possible cause: The magnet has been mounted incorrectly polarized. → Alter the mounting direction.

Possible cause: The action has been assigned incorrectly to the switching input. → Check the settings in CV 62 or 64.

Possible cause: The connection points X13 and/or X14 have been programmed for use as servo outputs. → Check the settings in CV 62 and 64 and in function mapping.

Problems with the sound playback

- There is no sound to be heard after switching on.
Possible cause: The loudspeaker has been connected incorrectly.
→ Check the connections.
Possible cause: A wrong function (or direction) has been assigned to a sound in function mapping. → Check the settings.
Possible cause: The assignment of the sounds to a switching input is wrong. → Check the settings in CV 62 and 64.
- The sound playback is bad, the loudspeaker hums, you can hear disturbing noises. → Mount a buffer capacitor and a suppression choke.

Problems with switching the servo

- The servo does not move.
Possible cause: The left and the right stop are defined incorrectly.
→ Check the settings in CV 121, 122, 125, 126.
Possible cause: The connection points X13 and/or X14 have been programmed for use as switching inputs. → Check the settings in CV 62 and 64.
Possible cause: A wrong function (or direction) has been assigned to the servo output in function mapping. → Check the settings.
Possible cause: The servo has been mounted incorrectly. → Check the connections.
Possible cause: The power supply is connected incorrectly → Check the connections.

Problems with testing the impulse generator for distance and speed measuring

When having configured F0r as an impulse generator in CV 102 the lighting connected to F0r should be switched on or off at every impulse.

- The lighting connected to F0r does not switch.

Possible cause: Magnet(s) and impulse generator have been mounted that way the impulse generator does not detect the magnet(s). → Check the mounting of magnet(s) and impulse generator.

- The lighting connected to F0r flashes shortly (possibly two times), the pauses between the flashes are unevenly long.

Possible cause: The distance between magnet(s) and impulse generator is too long. → Reduce the distance(s).

- The lighting connected to F0r flickers.

Possible cause: Interference voltages. They are possibly caused by other nearby locomotives, accessories in the vehicle (e.g. servos being readjusted). → Eliminate the interfering sources. The cable between the switching input (X13) and the impulse generator should be as short as possible. Mounting an anti-interference capacitor (e.g. 1.5 nF) between switching input (X13) and earth connection (X15) possibly reduces the effects of the interference voltages.

Problems with the POM-Update

- While updating the decoder the lighting starts to flash, the update is interrupted.

Possible cause: The settings for the POM-Update are wrong. → Check and alter the settings if necessary. The helpfile contains explanations.

Hotline

If problems with your decoder occur, our hotline is pleased to help you (mail address on the last page).

Repairs

You can send in a defective decoder for repair (address on the last page). In case of guarantee the repair is free of charge for you. With damages not covered by guarantee, the maximum fee for the repair is 50 % of the sales price according to our valid price list. We reserve the right to reject the repairing of a decoder when the repair is impossible for technical or economic reasons.

Please do not send in decoders for repair charged to us. In case of warranty we will reimburse the forwarding expenses up to the flat rate we charge according to our valid price list for the delivery of the product. With repairs not covered by guarantee you have to bear the expenses for sending back and forth.

11. Guarantee bond

For this product we issue voluntarily a guarantee of 2 years from the date of purchase by the first customer, but in maximum 3 years after the end of series production. The first customer is the consumer first purchasing the product from us, a dealer or another natural or juristic person reselling or mounting the product on the basis of self-employment. The guarantee exists supplementary to the legal warranty of merchantability due to the consumer by the seller.

The warranty includes the free correction of faults which can be proved to be due to material failure or factory flaw. With kits we guarantee the completeness and quality of the components as well as the function of the parts according to the parameters in not mounted state. We guarantee the adherence to the technical specifications when the kit has been assembled and the ready-built circuit connected according to the manual and when start and mode of operation follow the instructions.

We retain the right to repair, make improvements, to deliver spares or to return the purchase price. Other claims are excluded. Claims for secondary damages or product liability consist only according to legal requirements.

Condition for this guarantee to be valid, is the adherence to the manual. In addition, the guarantee claim is excluded in the following cases:

- if arbitrary changes in the circuit are made,
- if repair attempts have failed with a ready-built module or device,
- if damaged by other persons,
- if damaged by faulty operation or by careless use or abuse.

12. EU declaration of conformity

 This product conforms with the EC-directives mentioned below and is therefore CE certified.

2004/108/EG on electromagnetic. Underlying standards: EN 55014-1 and EN 61000-6-3. To guarantee the electromagnetic tolerance in operation you must take the following precautions:

- Connect the transformer only to an approved mains socket installed by an authorised electrician.
- Make no changes to the original parts and accurately follow the instructions, connection diagrams and PCB layout included with this manual.
- Use only original spare parts for repairs.

2011/65/EG on the restriction of the use of certain hazardous substances in electrical and electronic equipment (ROHS). Underlying standard: EN 50581.

13. Declarations conforming to the WEEE directive



This product conforms with the EC-directive 2012/19/EG on waste electrical and electronic equipment (WEEE).

Don't dispose of this product in the house refuse, bring it to the next recycling bay.

Information and tips:

<http://www.tams-online.de>

Warranty and service:

Tams Elektronik GmbH

Fuhrberger Straße 4

DE-30625 Hannover

fon: +49 (0)511 / 55 60 60

fax: +49 (0)511 / 55 61 61

e-mail: modellbahn@tams-online.de

