

HIGH END  
MOTORCYCLE  
TRAVEL  
EQUIPMENT



NEW IDEAS FOR MOTORBIKES

**TOURATECH**



**EXPLORE**

BMW  
HONDA  
KTM  
TRIUMPH  
YAMAHA  
AND MORE...



CATALOG ENGLISH / AMERICAN

**2022/2023**

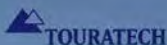

MOTORCYCLE ADVENTURE

1



## IMPRESSUM

Appears annually at  
**TOURATECH GmbH**  
Auf dem Zimmermann 7-9  
78078 Niedereschach  
GERMANY  
Tel.: +49 (0) 77 28 92 79-0  
Fax: +49 (0) 77 28 92 79-29  
info@touratech.de  
www.touratech.de  
www.touratech.com

### **Publisher**

TOURATECH GmbH

### **Editors | DTP**

Touratech Marketing | Volker Haller  
Touratech Product Management | Dan Prume

### **Development and Prototypes**

Touratech Research & Development

### **Photography** (unless otherwise noted)

Touratech, Katja Wickert, Katharina Ußling,  
Andrej Justus, Jo Wolfram and Claudius Vasilescu

### **Layout**

Touratech Marketing | Volker Haller | Christiane Schott

### **Translations** (Germany)

Tetraserv, RKT, Tectranslate

### **Printing**

GGP Media GmbH, Pößneck (Germany)

### **Overall organisation**

Touratech Marketing | Volker Haller  
Touratech Product Management | Dan Prume

Marc Pelzer (Owner),  
Nadine Arglebe (CFO),  
Alberto Reinhart (CEO)



Silke Winterer (OEM),  
Jochen Schanz (COO),  
Martin Wickert (CMO),



### **Hello Adventure Rider,**

Here it is: the new Touratech Catalogue 2022! On the following 800 pages you will find a concentrated bundle of ideas for your motorcycle adventures, new and proven parts for all the major adventure bikes, and a great many accessories already for some brand new motorcycles. We now have parts on offer for the freshly overhauled KTM 390 Adventure as well as for its big sister, the super-sporty 890. And that's not the end of it.

### **Adventure bikes 2022: more attractive than ever!**

The already wide and very attractive range of adventure bikes available at present will be supplemented by a few more delicacies in the coming season. Husqvarna sends the long-awaited Norden onto the tracks, Aprilia has created a contemporary reinterpretation of the legendary Tuareg, Triumph has almost reinvented the Tiger 1200, Harley is celebrating its off-road premiere, packing a powerful punch, and Ducati surprises us with an adventure bike in its purest form, the no-frills DesertX. A newcomer in this segment, the Italian high-end manufacturer MV Agusta takes the stage with two models, the Lucky Explorer 9.5 and the 5.5 as a tribute to the legendary „Desert Elephants“. Our experts have already „investigated“ these bikes, so you can expect the first parts soon.

### **Concentrated information on many channels**

Our newsletter and a regular look in our online shop - which now has an extensive magazine section - will keep you up to date on the new parts available for your bike.

À propos: you can also pick up the latest information at our „Rolling Trade Fair“. Our show truck with exhibition trailer will be driving to selected events and meeting points throughout the season. On board, there are not only fully equipped motorcycles to test ride but also, of course, the freshest parts made in Niedereschach.

And in this context, not to be overlooked, our customer magazine Travel Time, which provides you with gripping travel reports, technology features and scene news.

### **ACT Pyrenees**

It is well known in the scene that testing is nowhere harder than at Touratech. You can see what adventures we had on our ride through the Pyrenees on our YouTube channel. And there is more: you can experience this tour for yourself, because we have routed the fifth Adventure Country Track (ACT) through this very fascinating mountain range. Facts about this exciting project and how to ride an ACT yourself can be found here in this catalogue.

### **Touratech Suspension: 400 new suspensions**

A year of hard work lies behind our suspension team, with the result that spring elements from Touratech Suspension are now available not only for adventure bikes but also for the entire range from cruisers and sports bikes to youngtimers.

### **Experience adventure together with others**

We want to celebrate and ride together with you again this year. Make a note of the Travel Event in Niedereschach, the Adventure Bike Show Adventure Camp in Mammutpark and the Active Adventure with off-road locations throughout the Black Forest!

Your Touratech team wishes you a lot of enjoyment with this catalogue and an eventful motorcycle season!

### **Keep up to date:**

[www.touratech.com/magazine](http://www.touratech.com/magazine)

*Best regards,  
your Touratech Team*



# GERMANY



## TOURATECH Allgäu

Adventure Company A7 GmbH  
In der Paint 12  
87730 Bad Grönenbach  
+49 (0)8334 36 29 399  
info@touratech-allgaeu.de  
www.touratech-allgäu.de



## TOURATECH Karlsruhe

Bohling u. Eisele  
& Co. GmbH  
Eisenbahnstr. 40  
76229 Karlsruhe  
Tel: +49 (0)721 7907770  
info@bohling-eisele.de  
www.bohling-eisele.de



## TOURATECH Kassel

Dresdener Str. 1  
34125 Kassel  
Tel: +49 (0)561 941 50 96  
Fax: +49 (0)561 941 50 97  
info@touratech-kassel.de  
www.touratech-kassel.de



## TOURATECH Mitte

Zweirad Norton GmbH  
Obernburger Str. 46/48  
63853 Mömlingen  
Tel: +49 (0)60 22 68 17 06  
Fax: +49 (0)60 22 68 17 08  
info@zweirad-norton.de  
www.zweirad-norton.de



## TOURATECH München

Gruber & Alt GmbH  
Auf den Schrederswiesen 30  
80995 München  
Tel: +49 (0)89/46 13 58 30,  
Fax: +49 (0)89/46 13 58 31  
info@touratech-sued.de  
www.touratech-sued.de



## TOURATECH Nord

Holstenhofweg 42 - 44  
22043 Hamburg  
Tel: +49 (0)40 21 90 46 55  
Fax: +49 (0)40 21 90 48 97  
info@touratech-nord.de  
www.touratech-nord.de



# TOURATECH HEADQUARTERS

Auf dem Zimmermann 7 - 9  
78078 Niedereschach  
GERMANY  
Tel: +49 (0)77 28 92 79-0  
Fax: +49 (0)77 28 92 79-29  
info@touratech.de  
www.touratech.de  
www.touratech.com  
GPS  
N 48°07.573  
E 008°31.931

## SHOP HEADQUARTERS:

Dauchinger Str. 80  
78078 Niedereschach

## OPENING HOURS / ÖFFNUNGSZEITEN

Monday-Friday /  
Montag-Freitag:  
10:00 – 18:00 h  
Saturday / Samstag:  
10:00 – 14:00 h



## TOURATECH West

KOHL-Automobile GmbH  
Neuenhofstr. 160  
52078 Aachen  
Tel: +49 (0)241 568 84 62  
Fax: +49 (0)241 568 81 87  
thomas.nick@kohl.de  
www.touratech-west.de

# WORLDWIDE

## ARGENTINA

### Bamp Group

Calle 14 Nro. 1010

Tolosa - La Plata

Provincia de Buenos Aires

Tel: +54-911-5305-7778

## AUSTRALIA

### Touratech Australia

1933 Carboor - Everton Road

Carboor, Victoria 3678

Tel: +61 357 295 529

www.touratech.com.au

info@touratech.com.au

## AUSTRIA

### Touratech Österreich

c/o Bierbaum GmbH

Vöslauerstraße 67

2500 Baden bei Wien

Tel: +43 2252 / 254300

www.touratech.at

info@touratech.at

## BELGIUM

### Touratech Belgium

Tel: +49 7728 / 92790

www.touratech.be

info@touratech.be

## CANADA

### Touratech Canada

1661 chemin de l'industrie,

Local 111

Beloëil, Québec

J3G 0S5 | CANADA

Tel: +1 855 363.6686

motomotto.ca

info@motomotto.ca

## CHILE

### COMERCIAL TUFE S.A.

Avenida el Retiro 1270 35/36B

Santiago de Chile / Renca

Tel: +562 4781195

www.mototechnik.cl

info@mototechnik.cl

## CHINA

### Hefei Tutaik Trading Co. Ltd

Room 2105, Building 16

West Mountain Gingko Garden

No. 1833 Huaining Road,

Shushan District

Hefei, Anhui 230000

CHINA

Tel: +86 136 0551 2625

michael@touratech.cc

## COSTA RICA

### Moto Matti S.A.

Nacascolo Holdings, 3er piso

Torre Lexus,

Avenida Escazu, Escazu,

San Jose, COSTA RICA

www.touratech.co.cr

info@touratech.co.cr

Tel: +506-4010-6600

## COLOMBIA

### AUTOCOLOMBIANA SAS

Calle 127a # 7-12

Edificio BMW Plaza

Bogota, COLOMBIA

tourstore@autocolombiana.

com.co

Tel: +57 312 3085568

## CZECH REPUBLIC

### Touratech CZ

Modletice 142

25101 Ricany okr. Praha

Tel: +420 602 349970

+420 602 100677

www.touratech.cz

shop@touratech.cz

## DENMARK

### Touratech Denmark

dk.touratech-nordic.com

Tel: +49772892790

info@touratech-nordic.com

## ECUADOR

### INSUME CIA LTDA

BeloHorizonte E9-22

y 6 de Diciembre

PB 17-11-6504

Zip Code 170150

Quito | ECUADOR

Tel: +593 98 880 5500

## Touratech Cuenca

Av. Gran Colombia 22-239 y U.

Nacional,

Ed. River Palace LC 4

Cuenca, ECUADOR

## EL SALVADOR

### Motorider, S. A. de C. V.

Km 26 1/2 carretera a Santa Ana

San Juan Opico

EL SALVADOR

Tel: +503 7683 7048

www.touratech.com.sv

info@touratech.com.sv

## FINLAND

### Touratech Finland

fi.touratech-nordic.com

Tel: +49772892790

info@touratech-nordic.com

## BIKETEAM

Antaksentie 4,

01510 Vantaa Finland

www.biketeam.fi

tomi.kurkilahti@biketeam.fi

Tel: +358 207417217

## BIKETEAM PIRKKALA

Autokeskuksentie 12,

33960 Pirkkala Finland

## BIKETEAM RAISIO

Tuotekatu 12, 21200

Raisio, Finland

## BIKETEAM EUROBIKER

Antaksentie 4 B, 01510

Vantaa Finland

www.eurobiker.fi

sami@eurobiker.fi

Tel: +35895656040

## FRANCE

### Touratech France

www.touratech-france.com

info@touratech-france.com

E-mail SAV et support :

support@touratech-france.com

Tel: +33 97 30 51 056

## Touratech Orange

Rue Roussanne

ZAC Porte Sud, BP 124

84100 Orange

FRANCE

Tel: +33 4 90 34 85 24

www.motoadventure.fr

info@motoadventure.fr

## GREECE | CYPRUS (EU)

### Makan Touratech Greece

Sfaktirias 6 street

10435 Athens

Tel: +30 21 12 16 98 88

www.touratech.gr

info@touratech.gr

## GUATEMALA

### Comercial Automotriz, S.A

Karl Sapper

Ruta 6 4-34 zona 4

GT-Ciudad de Guatemala

Tel: +502 2384 8000

www.bavaria.com.gt

## HUNGARY

### Full-Gas

Nyárfa u.13.

Balatonboglar, 8630

Tel: +36 85 550 560

touratech@fullgas.hu

www.touratech.hu

## INDIA

### Tusker Touratech India

Shop No.118, Lavelle Road

Bangalore – 560 001 India

Tel: +91 80 4949 7676

sales@touratech.in

## IRELAND

### Adventure Motorcycles

Ireland Ltd.

Unit 35 Gorey Business Park

Ramstown Gorey Co.Wexford

Tel: +353 53 94 22415

www.touratech.ie

info@touratech.ie

## ISRAEL

**Touratech Israel  
ADVX LTD.**  
249 Hapeleg St.  
POB 143 Beerotaim  
4285000 ISRAEL  
www.touratech.co.il  
info@touratech.co.il

## ITALY

**SP161 S.r.l.**  
Via del Lavoro, 4/6  
20060 Vignate (MI) | Italy  
Tel: +39 02 09954021  
info@touratech.it  
www.shop.touratech.it

## JAPAN

**Touratech Japan**  
988, Nakano, Midori-Ku  
252-0157 Kanagawa  
Sagamihara-City, Japan  
Tel: +81 42 850 4790  
www.touratechjapan.com  
info@touratechjapan.com

## KOREA

**AUDIOPROBE Inc.**  
B205, Dangsang-ro 41-gil 11,  
Yeongdeungpo-Gu,  
Seoul, 07217 South Korea  
Tel: +82-70-7668-4902  
www.senamoto.kr  
touratech@senakorea.kr

## MALAYSIA

**Touratech Malaysia**  
Route 77 Adventure Sdn. Bhd.  
Block A, Lot 67, No. 7,  
Jalan Kilang 51/205, Seksyen 51,  
46050 Petaling Jaya, Selangor.  
MALAYSIA  
Tel: +6 03 77857777  
info@route77adv.my

## MEXICO

**Touratech Mexico Toluca**  
Toluca Planta de Distribución  
SA de CV Km 47.5 Carr. México –  
Toluca MX 52005 Lerma  
Tel: +52 722 262 98 51  
carmen.garcia@  
plantatoluca.com

## MIDDLE EAST

**Touratech Middle East**  
Warehouse 5, Street 6th  
Alqouz 3  
Dubai, UAE  
Tel: +971506510770  
info@touratech.ae

## NETHERLANDS

**Touratech Nederland**  
Tel: +31 97 010280772  
www.touratech.nl  
info@touratech.nl

**Touratech NL Mill**  
Houtzagerijstraat 5  
5451 hz Mill, nederland  
info@touratech-mill.nl  
Tel. +31 6 53870041

**Touratech NL North**  
BlueRider  
Hogeweg 1, 9801 TG ,  
Zuidhorn, The Netherlands  
Tel: +31 06 13 55 98 49  
Bluerider.nl  
info@bluerider.nl

## NEW ZEALAND

**Motomart**  
7 Rutherford Street  
Lower Hutt 5010  
Wellington  
Tel: +64 45895106  
www.touratech.co.nz  
touratech@motomart.co.nz

## NORWAY

**Touratech Norway**  
no.touratech-nordic.com  
Tel: +49 77 28 92 790  
info@touratech-nordic.com

## PERU

**Motoviajeros Peru S.A.C.**  
Av. Los Faisanes #196,  
Urb. La Campiña - Chorrillos  
Lima, 09 Peru  
Tel: +51 1234 2191  
www.touratech.pe  
info@touratech.pe

## PHILIPPINES

**HLT International Inc.**  
Unit 4 Pelbel 2 Bldg. Shaw Blvd.  
1600 Pasig City

Tel: +632 63 551 95  
www.touratech.ph  
info@touratech.ph

## POLAND

**Touratech Polska**  
Tel: +48 22 1531700  
www.touratech.pl  
info@touratech.pl

**Touratech Bielsko-Biala**  
Suzi-Moto  
ul. Kreta 78  
43-502 Czechowice-Dziedzice  
Tel. +48 575 170 700  
biuro@touratech.suzimoto.pl

## Touratech Łódź

Liberty Motors  
ul. Dąbrowskiego 207/213  
93-232 Łódź  
Tel: +48 723 732 046  
touratech@libertymotors.pl

## Touratech Piaseczno

Liberty Motors  
ul. Puławska 44D  
05-500 Piaseczno  
Tel: +48 22 233 0815  
touratech@libertymotors.pl

## Touratech Kraków

Moto-Tour  
ul. Al 29-Listopda 170  
31-326 Kraków  
Tel: +48 602 138 128  
info@moto-tour.com.pl

## PORTUGAL

**Longitude 009**  
Avenida Infante D. Henrique  
Edifício Beira Riio, Fração T  
1950-408 Lisboa  
Tel: +351 218 650 244  
info@touratech.pt  
www.touratech.pt

## ROMANIA

**Romania Motorcycle Tours**  
Str. Dr. Draghiescu, nr.12,  
camera 1, et.1, ap 2, sector 5,  
București, ROMANIA  
Mobile: +40-731-141931  
shop.touratech.ro  
Tel: +40 731 141 931  
info@touratech.ro

## RUSSIA

**WikiMoto**  
Instrumental' naya str. 3, lit. V  
197022 Saint-Petersburg  
Tel: +7 (812) 677 94 35  
www.touratech.ru  
info@touratech.ru

## SERBIA

**Touratech Serbia  
TAGO CAR d.o.o.**  
Zrenjaninski put no.6  
Novi Sad , 21000  
SERBIA  
www.touratech.rs  
info@touratech.rs

## SINGAPORE

**Touratech Singapore**  
Route 55 Adventures Pte Ltd  
38 Ang Mo Kio Industrial Park 2  
#03-53 Singapore 569511  
SINGAPORE  
Tel: +65 9229 0055  
www.touratech.sg  
touratechsg@hotmail.com

## SLOVAKIA

**Touranbike**  
Alzbeta 27  
05801 Poprad  
Tel: +421 905 790 246  
www.touratech.sk  
info@touratech.sk

## SOUTH AFRICA

Bike Adventure Imports  
(Pty) Ltd  
T/A Touratech South Africa  
Unit A008, One Highveld  
5 Bellingham Road  
Centurion | South Africa | 0157  
Tel: +27 (0) 12 665 1139  
Cell: +27 (0) 60 786 6185  
info@touratech.co.za  
www.touratech.co.za

## SPAIN

**Touratech España**  
www.touratech.es  
info@touratech.es  
Tel: +34 965 656 754



Touratech THAILAND

#### Alicante

Avenida Hospital, 10  
03550 San Juan De Alicante  
Tel: +34 965 656 754  
info@touratech.es

#### Barcelona

Carrer de Nicaragua, 48,  
08029 Barcelona, Spain  
Tel: +34 935 284 828  
barcelona@  
motocentercompany.com  
**Madrid**  
Celle. Euclides, 11  
28806 Alcalá de Henares,  
Madrid, Spain  
Tel: +34 911 520880  
madrid@  
motocentercompany.com

#### Malaga

C. Reserva, 51,  
29130 Alhaurin de la Torre,  
Málaga  
Tel. +34 952 41 43 59  
malaga@  
motocentercompany.com

#### SWEDEN

**Touratech Sweden**  
se.touratech-nordic.com  
Tel: +49772892790  
info@touratech-nordic.com

#### Gothenburg

Kenneths MC-Service AB  
Tagenevägen 21,  
425 37 Hisings Kärra, Sweden  
Tel: +46 031-51 64 12  
www.kennethsmc.se

#### Helsingborg

Nilssons MC  
Kanongatan 159  
254 67 Helsingborg, Sweden  
Tel: +46 042-159511  
www.nilssonsmc.se  
info@nilssonsmc.se

#### SWITZERLAND

Touratech Swiss  
Happich Pelzer GmbH  
Luzernerstrasse 38  
6030 Ebikon/Luzern  
SWITZERLAND  
Tel: +41 41 3109700  
www.touratech-swiss.ch  
info@touratech-swiss.ch

#### THAILAND

**Touratech (Thailand) Co., LTD**  
126 Moo 6 Wat Sriwaree noi Road  
Srisajorakhaeyai  
Bangsaothong  
Samutprakarn 10540  
Tel: +66 2327 9361  
www.touratech.co.th  
info@touratech.co.th

#### TURKEY

**Zega Motorlu Araçlar  
Tic. ve Servis Ltd. Şti.**  
Tuna Plaza  
Zümrütevler Mah.  
Nazmi İlker Sok. No: 8  
Maltepe / Istanbul  
Tel: +90 216 3603263  
info@touratech-tr.com  
www.touratech-tr.com

#### UNITED KINGDOM

**Touratech UK**  
www.touratech-uk.co.uk  
info@touratech-uk.co.uk  
Tel: +44(0) 208 089 96 92

#### Touratech UK North

Hermod  
322G Mayoral Way  
Team Valley | Gateshead  
NE11 0RT  
Tel: +44(0) 1914 871 123  
www.hermod.co.uk  
info@hermod.co.uk

#### Touratech UK South

Rugged Roads Ltd  
20 Waterloo Road  
Lymington, Hampshire  
SO41 9DB, UK  
Tel: +44 1590 675657  
touratech@ruggedroads.co.uk  
www.ruggedroads.co.uk

#### Touratech UK South East

Adventure Bike Shop Ltd  
Unit 19 Inca Business Park  
Melford Road | Acton  
Sudbury, Suffolk | CO10 0BB, UK  
Tel: +44(0) 1787 372 901  
www.adventurebikeshop.co.uk  
enquiries@  
adventurebikeshop.co.uk

#### Touratech UK Wales

Adventure Bike Store Ltd  
Unit 16 Woodlands Business  
Park, Ystradgynlais, South  
Wales, SA9 1JW UK  
Tel: +44(0) 1639 841 765  
info@adventurebikestore.co.uk  
www.adventurebikestore.co.uk

#### USA

#### Touratech USA

4021 Airport Way South  
Seattle, WA 98108  
Tel: +1 206-323-2349  
Toll free: +1-800-491-2926  
www.touratech-usa.com  
sales@touratech-usa.com

#### Touratech USA EAST

COMING SOON!

#### Touratech MIAMI

7501 NW 36th Street  
Miami, FL 33166 USA  
Tel. +1 786-845-0052

#### BOB'S BMW MOTORCYCLES

10720 Guilford Road  
Jessup, MD 20794  
Tel. +1 301-497-8949  
www.bobsbmw.com  
parts@bobsbmw.com

#### VIETNAM

#### Pit Stop Auto & Events

224 Mai Chi Tho  
An Phu Ward, District 2  
Ho Chi Minh City  
Tel: +84 8 3620 6677  
www.touratech.vn  
info@touratech.vn

**MADE FOR ADVENTURE.**





# CONTENT

Imprint	p. 2	Aluminum Panniers + Equipment	p. 436
Foreword	p. 3	Soft Luggage	p. 514
Headquarters	p. 4	Touratech Waterproof	p. 546
Distributors	p. 5	Seats	p. 572
Index	p. 8	Wind shields	p. 588
Catalog Navigation	p. 10	Touratech Suspension	p. 596
Touratech Online	p. 16	Special Parts	p. 628
		Equipment	p. 646
BMW R 1250   1200 GS   ADV (LC)	p. 18	<b>Story: ACT Pyrenees</b>	<b>p. 746</b>
BMW R 1200 GS   ADV (AC)	p. 130		
<b>Customspecials</b>	<b>p. 172</b>	Lifestyle	p. 754
BMW F 850 GS	p. 174	Navigation   Communication	p. 766
BMW F 800   700 GS	p. 200	Outdoor	p. 796
<b>Story: Made in Germany</b>	<b>p. 226</b>		
		<b>Travel Time</b>	<b>p. 806</b>
Honda CRF 1100 L Africa Twin	p. 238	General Terms and Conditions	p. 808
Honda CRF 1000 L Africa Twin	p. 274	Gift Voucher	p. 813
Harley-Davidson Panamericana	p. 306	Touratech Online	p. 814
KTM 1290   1190   1050 ADV	p. 320	Contact Information	p. 815
KTM 890   790 Adventure   R	p. 354		
KTM 390 Adventure	p. 380		
Triumph Tiger 900	p. 386		
Yamaha Ténéré 700	p. 398		
<b>Story: Martin Leonhardt</b>	<b>p. 426</b>		



For more adventure  
equipment please visit  
**TOURATECH.COM**



## BMW R 1250 | 1200 GS | ADV

p. 18



R 1250 | 1200 GS | ADV

## BMW R 1200 GS | ADV AC

p. 130



R 1200 GS | ADV AC

## BMW F 850 | 750 GS

p. 174



F 850 | 750 GS

## BMW F 800 | 700 GS

p. 200



F 800 | F 700 GS

## Honda CRF 1100 L Africa Twin

p. 238



CRF 1100 L AFRICA TWIN

## Honda CRF 1000 L Africa Twin

p. 274



CRF 1000 L AFRICA TWIN

**Harley Pan America**

p. 306



HARLEY PANAMERICANA

**KTM 1290 | 1190 | 1050 ADV**

p. 320



1290 | 1190 | 1090 ADV

**KTM 890 | 790 ADV/R**

p. 354



790 | 890 ADVENTURE / R

**KTM 390 ADV**

p. 380



KTM 390

**Triumph Tiger 900**

p. 386



TRIUMPH TIGER 900

**Yamaha Ténéré 700**

p. 398



YAMAHA TÉNÉRÉ 700



ALUMINUM PANNIERS

## Aluminum Panniers

p. 436



## Accessories

p. 477



ACCESSORIES

SOFT LUGGAGE

## Soft Luggage

p. 514



## Touratech Waterproof

p. 546



WATERPROOF

SEATS

## Seats

p. 572



## Wind Shields

p. 588



WIND SHIELDS

## Touratech Suspension

p. 596



TOURATECH SUSPENSION

## Special Parts

p. 628



SPECIAL PARTS

## Equipment

p. 646



EQUIPMENT

## Lifestyle | Fan

p. 754



LIFESTYLE | FAN

## Navigation Communication

p. 766



NAVIGATION | COMMUNICATION

## Outdoor

p. 796



OUTDOOR



**YOU HAVE NOT  
FOUND YOUR  
MOTORCYCLE IN  
THE CATALOG?**



**ACCESSORIES FOR  
OVER 400 MODELS  
IN THE WEBSHOP!**



For more motorbike  
models please visit  
**TOURATECH.COM**

# STORIES

**Made in Germany**  
p. 226



**Martin Leonhardt**  
p. 426



**ACT  
Pyrenees**  
p. 746



- + All the news at a glance
- + New product topics and exciting travel stories as well as comprehensive news coverage of Touratech events
- + Special offers and new items
- + Detailed product information incl. 360° views, videos and mounting instructions



## Many more products in our webshop!



[touratech.com](http://touratech.com)

Shop from home!  
All the news at a glance!

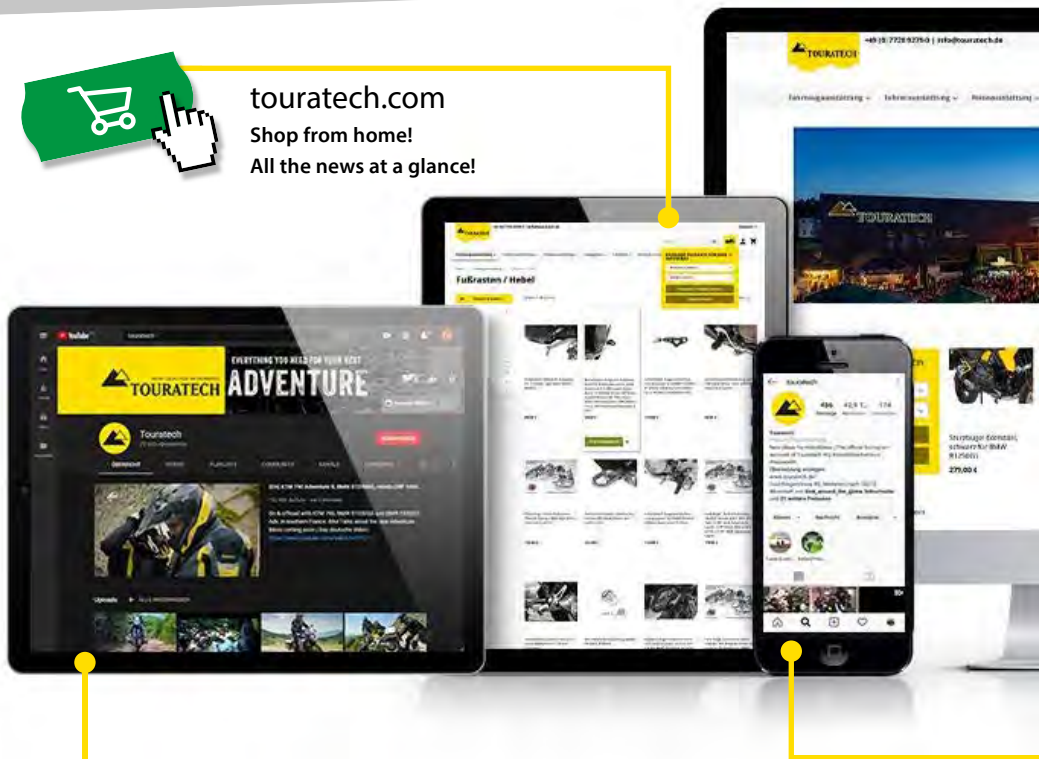

Touratech YouTube  
Watch the latest Adventure-Videos!  
[youtube.com/TouratechVideo](http://youtube.com/TouratechVideo)



USA: [touratech-usa.com](http://touratech-usa.com)  
UK: [touratech-uk.co.uk](http://touratech-uk.co.uk)  
CANADA: [motomotto.ca](http://motomotto.ca)  
INTERNATIONAL: [touratech.com](http://touratech.com)



# FIND THE EQUIPMENT FOR YOUR MOTORCYCLE!

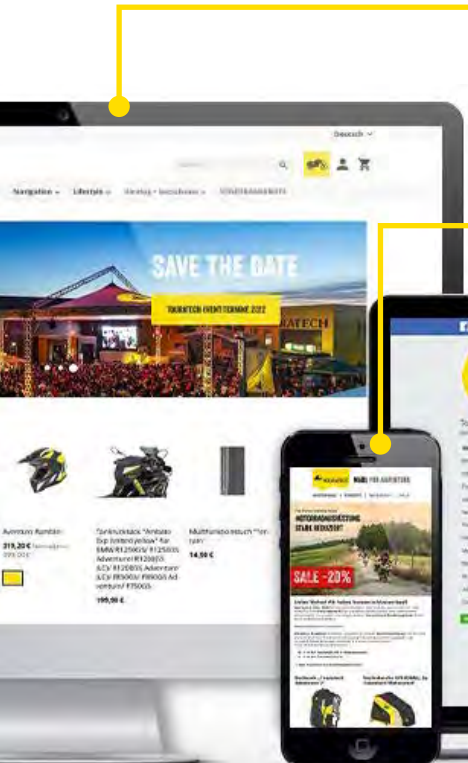

[touratech.com](http://touratech.com)  
All the news at a glance!  
Shop from home!



Touratech Newsletter  
Discover the latest news and offers!  
[www.touratech.com](http://www.touratech.com)

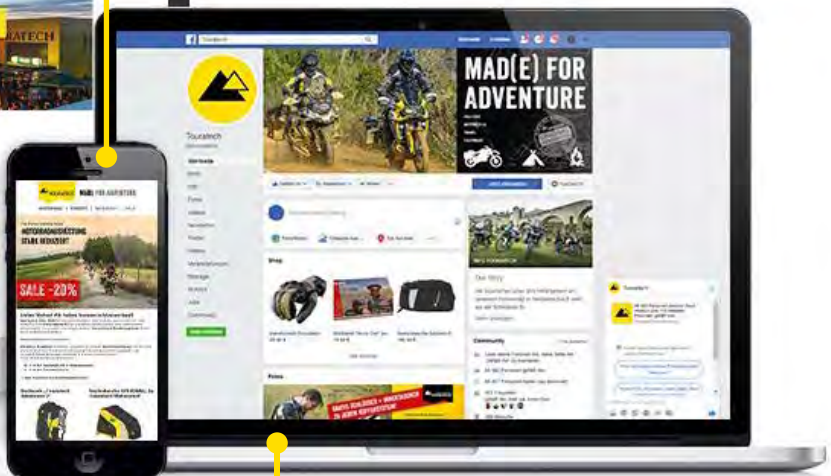

Touratech Instagram  
Get inspired!  
[instagram.com/touratech](http://instagram.com/touratech)



Touratech Facebook  
Be connected to the Touratech-Team!  
[facebook.com/touratech](http://facebook.com/touratech)



NEW IDEAS FOR MOTORBIKES

**TOURATECH**



- 1 Handlebar | Cockpit | Windscreens | Lighting from p. 20
- 2 Engine guard | Cylinder protection | Fairing from p. 39
- 3 Foot pegs from p. 70
- 4 Seats from p. 76
- 5 Suspension from p. 79
- 6 Tank bags from p. 86
- 7 Tail rack bags from p. 99
- 8 Pannier systems from p. 108



# BMW

R 1250 GS / ADV  
R 1200 GS / ADV  
(LC) LIQUID COOLED





# DESIERTO V

## Fairing Desierto V

BMW R 1250 GS / ADV / R 1200 GS (LC) / ADV (LC)

Desierto fairings have been setting standards for the conversion of a GS to an Adventure Enduro for the last 20 years. This conversion is now available in the fifth generation: The Desierto V! From the first design sketch, over 3D simulations and intense driving tests with prototypes, through to series production, the Desierto V is entirely a child of the house of Touratech.

Already at first glance, the Desierto V stands out from the standard GS, giving the impression of a stand-alone model with its striking appearance. The lines of the machine are skilfully taken up and developed to create a distinctive appearance with those edges so typical for Touratech.

Harmony of form and function: In addition to the new, individual design, you will be enchanted by the substantial improvement in the touring capability of your GS. The Desierto V combines maximum weather protection with optimal aerodynamics.





038-5445

Mudguard  
Extension  
p. 68





The Desierto V consists of two main components: A panel made of fibre-reinforced polyurethane, as well as a windscreen made of high quality, splinter-resistant Plexiglass. The proven original BMW mechanism is still used to adjust the screen. The tinted screen adds to the striking Desierto V Adventure look.

The lower section of the Desierto V fairing comes with a high-quality black paint finish as standard, which matches all available GS colour schemes perfectly.

Installation is exceedingly easy and, thanks to the general operating permit (ABE), TÜV approval is not required.

Naturally, the Desierto V also fits the Adventure, as well as the GS special models „Rally“ and „Exclusive“.

Order at the same time: Perfect the new, sporty Adventure look of your Desierto V GS with the matching mudguard extension and Touratech hand protectors!

R 1200 GS Adventure (LC): Not in combination with LED auxiliary headlights 045-5477 and 045-5479!

038-6300

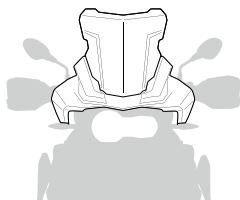





## Cockpit shield

**BMW R 1200 GS (LC) / Adventure (LC)**

The new anti-glare shield really enhances your BMW look.

The Touratech anti-glare shield has an extremely positive effect on the BMW. It makes the whole headlight look more appealing. The black plastic shield is easy to fit behind the windscreen.

045-5270 2013-2016

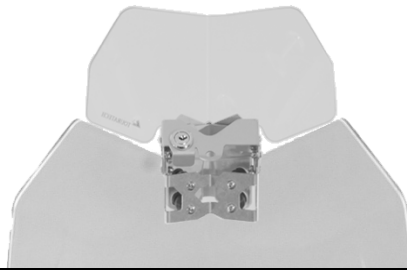

## Spoiler for windscreen, lockable

**BMW R 1250 GS / R 1200 GS (LC)**

This special spoiler for the windscreen of the BMW R1200GS is perfect for undertaking long, fast motorbike journeys in comfort. There is a significant reduction in turbulence and wind pressure against the helmet.

It simply fits onto the windscreen, and is secured using the snap closure. When going off-road, the spoiler is easy to remove in seconds.

A high quality brand lock secures the spoiler against unauthorised removal. The locks are also available with the same closure as our ZEGA Case and GPS bracket locks.

045-5350

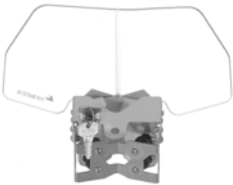

## Set rubber bushing for windscreen

**BMW R 1200 GS (LC) (2013)**

Necessary for mounting a Touratech windshield on your GS construction year 2013.

045-5349





## Windscreen, with ABE

BMW R 1250 GS / ADV

BMW R 1200 GS (LC) (2014-)/ ADV (LC)

Not satisfied with the original wind shield of your bike? Thanks to countless miles of adventure experience and to the know-how of our production department, we developed a wind shield that unites an appealing adventure design and an optimal function for every application.

Replace your original windscreen with the Touratech wind shield and discover much better driving properties! The form and function of the upper edge of the wind shield is based on our rally experience. The aerodynamic optimization guides the air streams over the head of the pilot without unnecessary turbulences. So, the wind shield is not only flatter-free, it also guarantees a relaxed driving pleasure that doesn't exhaust the pilot nor the pillion passenger. With ABE.

038-6200 S, transparent

038-6202 S, tinted

038-6210 M, transparent

038-6212 M, tinted

038-6220 L, transparent

038-6222 L, tinted



038-6220





### **Windscreen spoiler Evo, with ABE**

**BMW R 1250 GS / ADV / R 1200 GS (LC) / ADV (LC)**

Whether you need it for your original windscreen or as accessory to your new Touratech windscreen - with Touratech's windscreen spoiler Evo, you absolutely gain extra comfort on each terrain.

Evo offers the right balance between protection and ventilation - whether you drive on motorways, roads or off-road. Height, inclination and distance to the windscreen can easily be adjusted - you do not need any tools.

If you are going fast and the weather is rainy, fasten the spoiler at its highest level to benefit from an effective wind and weather protection. It is a noticeable relief for your head and upper body, and wind noises in your helmet are significantly reduced.

If you set the lowest level, the windscreen spoiler almost disappears. This guarantees maximum ventilation when riding off-road.

**040-1380 transparent**

**040-1381 tinted**

## Handlebar Riser with ABE

BMW R 1250 GS / ADV / R 1200 GS (LC) / ADV (LC)

It's often the little things that make all the difference! This is the case with the Touratech handlebar riser for the BMW R1250 GS & R 1200 GS. Raising the handlebar by 15 mm results in a more upright, much more relaxed seating position. The adjustment range of the handlebar angle is increased, which further increases rider comfort. The Touratech handlebar riser also makes riding while standing less tiring, which is of tremendous benefit to taller riders in particular.

The overall result is a noticeable increase in stamina and concentration. Long stretches on the motorway are less nerve-racking, and even fast, difficult sections off-road are easier to handle.

Material: silver anodised aluminium.

045-5255 15 mm

045-5256 25 mm

045-5257 40 mm



## Offset handlebar riser 35 mm with ABE

BMW R 1250 GS / ADV / R 1200 GS (LC) / ADV (LC)

Long-distance comfort and perfect handling - pure and unadulterated.

Our offset handlebar riser does not only raise the handlebar 35 mm, but also brings it 20 mm closer to the rider. This provides perfect ergonomics for tall riders and also allows a much sportier riding style.

We never leave home without it.

045-5258



## GPS Handlebar Bracket Adapter

BMW R 1250 GS / ADV / R 1200 GS (LC) / ADV (LC)

The bracket adapter is simply fitted to the handlebar mounting clamps on your BMW. Our GPS brackets all fit perfectly on its 12 mm brace. For easy, safe attachment of your GPS. With no impairment of the view of the instruments.

045-5410





037-5176

## TFT anti-theft

### BMW R 1250 GS / ADV / R 1200 GS (LC) / ADV (LC)

The TFT display of your GS is more than just a display instrument. It is the central communication unit in the interaction between man and machine. With its extensive functionalities, it is unfortunately also a very expensive component.

Did you know that your TFT display is only secured with three rather weakly dimensioned retaining rings? One strong pull on the housing and the entire TFT unit is gone.

With the TFT theft protection, this quick but expensive „theft“ is impossible!

The version with „sun visor“ also has a 45mm anti-glare screen.

The simultaneous use of Touratech or BMW navigation device holders is not restricted.



037-5177

### Safe and lightweight:

**2 mm black anodised aluminium**

037-5177

**2 mm black anodised aluminium, with sun visor**

037-5178

### Safe and solid:

**2 mm stainless steel black powder-coated**

037-5175

**2 mm stainless steel black powder-coated, with sun visor**

037-5176



## Windscreen stabilizer with GPS mounting bracket

### BMW R 1250 GS / ADV / R 1200 GS (LC) / ADV (LC)

The windshield of the GS seems to be very unstable, which in the long run can lead to irritation and dangerous distractions.

This mounting adapter effectively stabilizes the windshield and replaces the original BMW GPS bracket. The bracket is wide enough for you to be able to position a GPS unit, for example, wherever you want. You can thus position your GPS unit properly above the instruments of your BMW.

It is fitted to the original attachment points, while the height adjustment is naturally retained. Compatible with original BMW and Touratech windshields.

045-5330



### Handlebar mounting BMW Navigator IV, V & VI, lockable

The BMW Navigator handlebar mount has been developed specifically for motorbike use.

The base mount with the power supply strip and control buttons on the side which is supplied with the BMW Navigator is integrated into the Touratech handlebar mount. Using the original BMW base mount on its own does not sufficiently protect the Navigator against the vibrations that occur specifically on motorcycles. Another feature of our handlebar mount is that the BMW Navigator securely locks into the motorcycle mounting.

065-0561

### Safety rear-view mirror set, aspherical, right-hand thread M10 x 1.5

BMW R 1250 GS / ADV / R 1200 GS (LC) / ADV (LC)

The Safety rear-view mirror is the ideal motorcycle mirror for your Adventure Bike. It fits any motorcycle with an M10 x 1.5 right-hand thread mirror mounting. The mirror not only looks great, it is also made of high quality and extremely sturdy plastic. Thanks to the aspherical part, the visible area is increased - making the „dead angle“ a thing of the past. The ball joint allows for easy adjustment of the rear-view mirror.

A worthwhile safety feature - for city traffic, roads and motorways! A set for both the left and the right side. With ECE test mark!

Dimensions: Total approx. (hwx) 160 x 260 mm,  
Glass approx. (hwx) 82 x 140 mm

040-0780





### Set of LED Auxiliary Headlights

BMW R 1250 GS / ADV / R 1200 GS (LC) / ADV (LC)

We use innovative LED headlights of 70 mm diameter for our auxiliary headlights. The excellent light output is made possible by the latest lighting technology and high-performance LEDs with a higher level of efficiency. Power consumption just 13 watts per headlight! (Halogen: ~55 watts).

	Set fog / fog, black	Set fog right / full beam headlight left, black
R 1200 GS   R 1250 GS	045-5471	045-5473
R 1200 GS ADV   R 1250 GS ADV	045-5477	045-5479

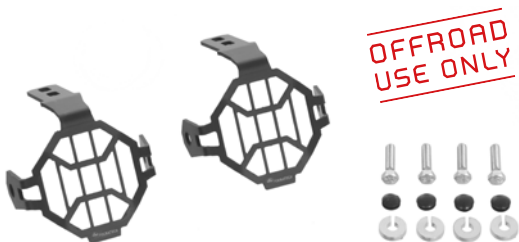

**OFFROAD USE ONLY**

### Headlight protector for original BMW LED fog headlight

BMW R 1200 GS (LC) (-2017) / Adventure (LC) (-2017)

Robust enough to protect against flying stones - filigree enough not to impair the lighting intensity!

This protector made of anodised black aluminium can be easily mounted on the original BMW LED fog auxiliary headlights.

045-5468



**OFFROAD USE ONLY**

### Headlight protector for original BMW LED „Nano“ headlight

BMW R 1250 GS / ADV / R 1200 GS (LC) / ADV (LC)

Robust enough to protect against flying stones - filigree enough not to impair the lighting intensity!

This protector made of stainless steel can be easily mounted on the original BMW LED „Nano“ auxiliary headlights.

Set for left and right!

038-5468 (2017-)

045-5095



**OFFROAD  
USE ONLY**

### Headlight Protector with Quick Release Fastener for LED Headlight

BMW R 1250 GS / ADV / R 1200 GS (LC) / ADV (LC)

Our headlight protector has been thoroughly tried and tested over the years – we've sold thousands.

Even the biggest stones won't be able to damage your headlight with this!

New durable stainless steel model now available with quick release fastener! Now you can clip on the headlight protector and detach it again as needed. Just bolt the sturdy and secure side struts. And of course the protector comes with everything you need to fit it. This headlight protector has been developed for off-road use and is not street legal.

037-5095



045-5091



045-5093



Stainless steel headlight protector black, with quick release fastener for LED bending headlight

037-5095

Headlight protector Makrolon Type 2 with quick release fastener

045-5091

Stainless steel headlight protector with quick release fastener

045-5093

Stainless steel black headlight protector with quick release fastener

045-5095

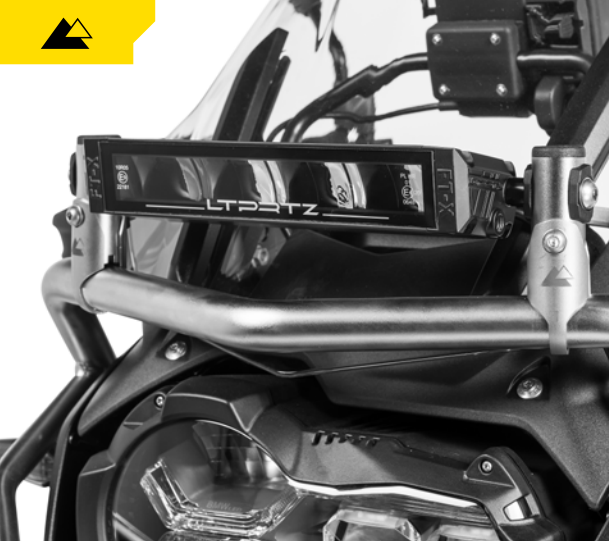

## LED Lightbar Aux light 30° FLOOD

### Special features:

- Certification as driving light and electromagnetic compatibility
- Homologation ECE R112 and R10
- Range: 300 m (1.0 Lx)
- Reference number: 20
- Shock- and waterproof
- UV-shielded

### Technical Data:

- Input Voltage: 12-24 V
- Light Source: 4x OSRAM LED Chips
- Power input: 31 W
- Raw lumens: 3360 lm
- Light spread: ECE driving pattern
- Light intensity: 83.600 cd
- Protection class: IP69K
- Lens: break-resistant polycarbonate
- Housing: die-cast Aluminium
- Connection: DT-plug
- Weight: 700 gr.
- Dimension: 224 x 67.2 x 38.5 mm

040-2023



## LED Lightbar Aux light 8° SPOT

### Special features:

- Certification as driving light and electromagnetic compatibility
- Homologation ECE R112 and R10
- Range: 377m (0.25Lx)
- Reference number: 12.5
- Shock- and waterproof
- UV-shielded
- Anodized polyester-powder coating
- Efficient polycarbonate-lensreflector

### Technical Data:

- Input Voltage: 9-36 V
- Light Source: 6x OSRAM LED Chips
- Power input: 14 W
- Raw lumens: 920 lm
- Light spread: ECE driving pattern Spot 8°
- Light intensity: 35.600 cd
- Protection class: IP68
- Lens: break-resistant polycarbonate
- Housing: die-cast Aluminium
- Mounting: standing | hanging
- Connection: DT-plug
- Weight: 324 gr.
- Dimension: 182.0 x 63.5 x 38.0 mm
- Hole distance: 113.0 mm

040-2022



## Crashbar "Bull Bar"

### BMW R 1250 GS Adventure

No matter what you intend to do with your GS, the Bull Bar is the perfect companion for adventures of all kinds. Whether you want to mount an additional light (fog lights, searchlights, etc.) or are looking for an exciting position for your ActionCam, the protective bar will not let you down. The tube is positioned above the headlamp and still allows unrestricted use of our headlamp guards (e.g. 01-045-5095-0).

- Material: 25mm stainless steel, electro polished
- Just as stable as Touratech crash bars and pannier racks
- Multiple use
- With additional light, active and passive safety is increased while driving
- Rounds off the adventure's off-road look

Note: Not suitable with the Desierto V (01-038-6300-0)

**037-5171 Bull Bar**

**037-5170 Bull Bar XL**



## Mounting adapter M6 | M8 for Bullbar additional headlights (set with 2 pieces)

You want to really light up the darkness? Then the Touratech Lightbar for the BMW R 1250 GS Adventure is exactly the right choice! With this attachment adapter, the Lightbar can be easily mounted on the Touratech Bull Bar's 037-5170 and 037-5171. In addition, the mounting adapters are also suitable for mounting almost any kind of auxiliary headlamp on 25 mm tubes with a comparable mounting angle! For example, also on crash bars.

**037-5173 M6 for 040-2022**

**037-5174 M8 for 040-2023**





Defensa PURE



Defensa EXTENSION  
(SPOILER)



Defensa EXPEDITION  
+ EXTENSION



037-5661



037-5661



037-5653

## Hand protectors DEFENSA

BMW R 1250 GS / R 1250 GS Adventure  
R 1200 GS (2013-) / R 1200 GS Adventure (2014-)

Whether off-road riding or touring – the Touratech Defensa offers reliable protection for handlebar fittings and hands, so that a minor mishap does not turn into a major problem. With the Defensa, Touratech has developed an extra-robust protector for handlebar fittings and hands. The construction made of high-strength aircraft aluminium is precisely adapted to your motorbike model. Thanks to the „Defensa System“, the protector offers interesting variation possibilities. Whether you choose a pure protector or a wide protector with an extra spoiler... Defensa hand protectors – for a particularly wide range of uses.

### Defensa Pure

- 037-5650 silver
- 037-5660 black

### Defensa Expedition

- 037-5651 silver / black
- 037-5652 silver / white
- 037-5661 black / black
- 037-5662 black / white
- 037-5653 yellow / black

### Defensa Extension

- 102-5651 black
- 102-5652 white

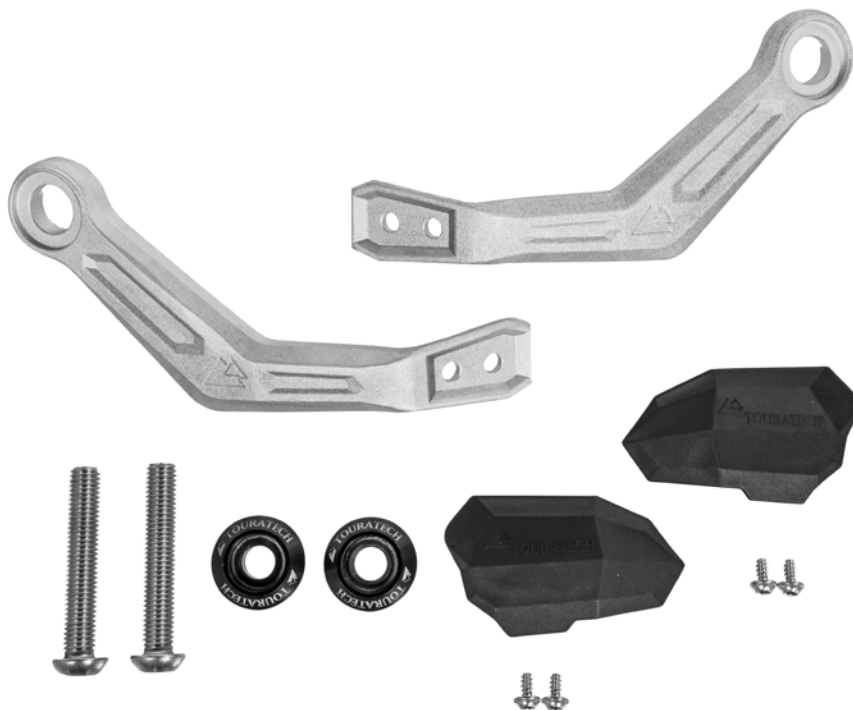

## DEFENSA Leverguard (Set)

BMW R 1250 GS / R 1250 GS Adventure  
R 1200 GS (2013-) / R 1200 GS Adventure (2014-)

For all motorbike purists, but thoughtful of their machine, the Defensa Leverguard will provide the right level of protection for the front brake and clutch levers.

To prevent you braking one or the other levers, Touratech proposes a simple, useful and aesthetic solution: the Defensa Leverguard. They do not only protect your levers in case of a crash, but they furthermore protect the levers from being hit by e.g. tree branches or car mirrors.

Made of high-strength drop forged aircraft aluminum and finished with a plastic nozzle as a matter of design, they are lightweight and stylish.

It can be adapted to become another variant of our Defensa portfolio: Pure or Expedition.

037-5655

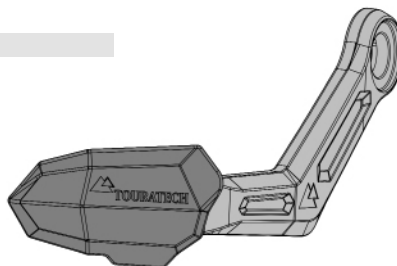
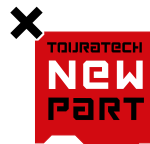



### Touratech Hand Protectors GD

BMW R 1250 GS / ADV / R 1200 GS (LC) / ADV (LC)

Unlike the original ones these hand protectors are not fitted to the clamps on the control units or brake unit but directly onto the tubular handlebars. This considerably reduces the risk of the hand brake lever mounting breaking off if you fall and thus making it doubtful whether you can continue riding. The hand protector can be combined with various spoilers and then offers optimum protection against wind and weather. A very strong, sturdy construction which has proved itself time and again in many rallies and on other motor cycles.

- Colours for hand protectors and spoilers can be combined at random
- Vibration isolation maintained (100%)
- For use in conjunction with heated grips
- Includes special adapters when fitted to R 1200 GS

**Hand protector colours:** black (X=0), white (X=4)

**Spoiler colours:** black (X=1), white (X=5)

**When ordering, please substitute the X on the end of the order number for the number in brackets.**

045-565X

### Spoiler for Touratech Hand Protectors GD, black

040-7301



### Spoiler for Original BMW Hand Protectors

BMW R 1250 GS / ADV / R 1200 GS (LC) / ADV (LC)

Optimal hand protection for the original protectors. Very useful and pleasant in rain, snow, hail and cold. The spoilers are made out of resistant and light synthetic. Easy to fix!

Very useful accessories for the GS-biker.

045-5665 (Set) black

045-5666 (Set) white

045-5667 (Set) red

## Touratech brake and clutch lever set, adjustable, folding and length adjustable

BMW R 1250 GS / ADV /  
R 1200 GS (LC) / ADV (LC)

The Touratech levers are milled from high-strength aluminum as in aircraft construction from the full. They are 6-way adjustable and hinged. In case of a fall the lever can fold up without breaking it. In normal operation, the levers are protected by a fold-up mechanism.

The levers are adjustable in length by dovetail connection by 35 mm. The anodization meets the highest quality standards. All screw connections comply with the DIN standard and are tightened before delivery with the torque wrench.

The CNC levers are delivered with German ABE (General Operating Permit) and are therefore registration free.

045-5640



## Touratech brake and clutch lever set, adjustable, short version

BMW R 1250 GS / ADV /  
R 1200 GS (LC) / ADV (LC)

CNC machined high-tech lever in the short version about 17 cm long and are therefore ideal for the so-called „two-finger brake system“.

High-strength aluminum (material: T6063 T6), which is also used in aircraft construction, milled from solid, weight only about 250 g (both sides).

We use a high quality anodization process which is tested for longevity and corrosion resistance.

The levers are adjustable by means of adjusting lever 6-fold at a distance to the handlebars.

045-5641





## Hard Part steering stop

BMW R 1250 GS / ADV / R 1200 GS (LC) / ADV (LC)

Even during minor accidents or if the motorcycle falls over, the front wheel may, for example, come into contact with the road surface so unfavourably that the standard steering stop on the yokes and calliper support is bent or shears off. Replacement of the yokes and calliper support is expensive and annoying, and additional parts may also be destroyed. The hard part is made of laser-cut stainless steel and tough plastic parts which absorb the impact. A small section is also muffled by a resilient rubber pad. The steering stop is barely restricted by the hard part.

The stainless steel part is coated with black plastic powder.

045-5296 / 045-5298 suitable for special model R 1200 GS „Rallye“ and R 1250 GS „HP“ with special equipment „sports suspension“.

045-5295 GS, black

045-5296 ADV, black

045-5297 GS, yellow

045-5298 ADV, yellow



045-5298



## Locking Oil Filler Cap

BMW R 1250 GS / ADV / R 1200 GS (LC) / ADV (LC)

044-0210



## Oil Filler Cap for Torx 50

BMW R 1250 GS / ADV / R 1200 GS (LC) / ADV (LC)

045-5230 black





## Engine guard RALLY

The symbiosis of advanced manufacturing technology and individual design!

The RALLY engine guard is designed to protect everything, from the manifold to the catalytic converter of your R 1200 GS. It fits all water-cooled R 1200 GS and Adventure models - including the 2017 model update! During development, we also paid attention to compatibility with the original BMW and Touratech crash bars. Thanks to innovative production technology, there are no disturbing welds, which are often considered to be a vulnerable point.

The unique design of the 4 mm thick aluminium part guarantees effective protection, high stability and gives your GS a sporty, modern look. The RALLY engine guard encloses your manifold like a protective sheath to protect it from all sides, in the best way possible. It hugs the body

of your BMW, guaranteeing maximum ground clearance. The positioning of side slots ensures that there is no need to worry about overheating, and cleaning with a high-pressure cleaner is a breeze. The organic, rounded forms provide for effective dissipation of energy in the event of impact. Jamming or snagging is also prevented. Direct impacts are compensated by the additional stainless steel plate inside. Due to the fact that the RALLY engine guard reaches behind the main stand of your GS, even the catalytic converter is effectively protected. Details such as starting chamfers protect the screw heads in the hard off-road use.

Thanks to the use of hex screws the installation / removal of the motor protection is very easy when you maintain your GS.

### BMW R 1200 GS (LC) / Adventure (LC)

045-5138

045-5139 black

### BMW R 1250 GS / ADV

037-5135

037-5136 black





## Engine Guard EXPEDITION

### BMW R 1200 GS (LC) / Adventure (LC)

In creating the BMW R 1200 GS, the developers at BMW have produced a motorbike that practically invites you take it on an off-road excursion. Our development team were able to make a number of further improvements to its positive off-road characteristics. This engine guard is an absolute revolution! Touratech have attached great importance to its robustness and functionality. Serious damage, such as holes in the engine block, can be effectively prevented by fitting the large Touratech engine guard. Maximum strength is provided by multiple folded ridges in the 4 mm thick aluminium base plate, while an additional lower stainless steel attachment plate

on the engine ensures the force of an impact is distributed over a large area via 6 bolting points. Ground clearance is not restricted by these two base plates. Another benefit is that the front of the engine guard rises up far enough to prevent damage to the oil filter and oil cooler as well. Plastic rails on the lower part of the base plate ensure that the bolt heads - which are already sunken - are completely covered. Not least, the plastic rails facilitate "sliding" the bike over rocks, stones and tree stumps.

Almost as an afterthought, they also prevent dirt build-up. To sum up, the large Touratech engine guard for the BMW R 1200 GS is a product that meets the most demanding requirements as well as being an absolute visual highlight!

045-5135 Expedition

038-5140 Expedition XL

038-5141 Expedition XL black

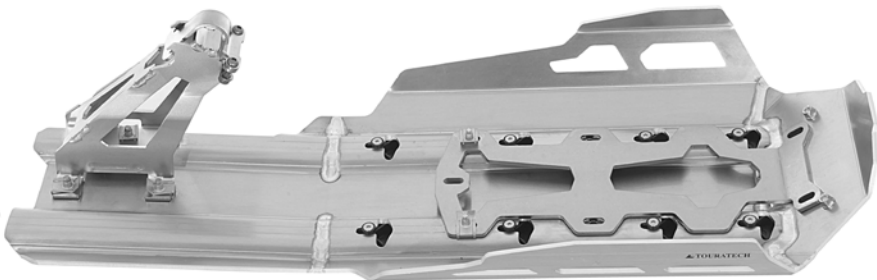

045-5135 Expedition

038-5140 Expedition XL





## Engine Guard Extension EXPEDITION

BMW R 1250 GS / ADV / R 1200 GS (LC) / ADV (LC)

We have developed an engine guard extension to go with our EXPEDITION engine guard. The design is the same, technically and optically. The EXPEDITION extension closes the gap between the engine guard and the rear wheel. An unbeatable advantage, especially off-road! Nothing can get stuck or caught around the main stand. This makes it much easier to "slide" over stones, rocks or tree stumps. The engine guard extension also protects parts of the exhaust from stones and other kinds of dirt that get thrown up. Also really useful in road use! The many angles of the 4-mm thick aluminium sheet provide maximum stability. There is no restriction of ground clearance. The EXPEDITION engine guard extension attaches to the main stand in moments.

045-5145



## Stainless Steel Crash Bar

### BMW R 1250 GS

No matter which way the GS should fall, the Touratech crash bar is right where it is needed. The most comprehensive all-round protection there has ever been for a boxer engine! A „cage“ of 25-mm strong, 2-mm thick stainless steel tubes completely encloses the cylinders. Any forces that occur are safely deflected and distributed to gently break them down. Numerous assembly points, intended bending points and the central strut guarantee safe protection not only of the cylinders, but also of the frame and engine of your R 1250 GS. Despite the impressive tube

diameter, the crash bar is positioned as closely as possible to the vehicle and has no effect at all on the leaning angles or ground clearance. Made exclusively of strong, electropolished stainless steel, the crash bar will not rust. Even deep scratches are less frightening, and can simply be ground off. The assembly points are perfectly matched to the R 1250 GS! And needless to say, everything that is needed to fit it is included in the delivery. TIP for perfect all-round protection: The perfect addition to the crash bar is our fairing crash bar for the R 1250 GS (037-5161/5163).

037-5160

037-5162 black



## Fairing crash bar stainless steel

### BMW R 1250 GS

On a long trip it can easily happen: just a minor fall or bump, and your tank and fairing are damaged. The Touratech crash bar extension protects the delicate radiator, the fairing and even the tank of the new boxer!

If the bike falls over, the crash bar will support it – so those expensive plastic parts will not get scratched or broken. In fact, the crash bar can take a serious beating.

As well as being functional, the stainless steel is a real eye-catcher. Suitable for combination with original BMW engine crash bar.

037-5161

037-5163    black







## Stainless Steel Crash Bar

### BMW R 1200 GS (LC)

A crash bar is definitely one of the most important components that you should add to your bike! The Touratech crash bar is the most comprehensive all-round protection there has ever been for a boxer engine! To protect the heart of your BMW, we use sturdy stainless steel tubing with a diameter of 2 mm and a wall thickness of 2 mm. Furthermore, the excellent design of its attachment locations makes fastening this one-piece bar to the threaded mounting points already provided by BMW a smooth and easy task.

In the event of a crash, the bar will very efficiently dissipate the associated energy and optimally distribute the resulting forces.

The electropolished surface of the stainless steel tubing is extremely tough and highly resistant to wear, even to deep scratches; rust is out of the question. Even deep scratches are less frightening, and can simply be ground off. The assembly points are perfectly matched to the R 1200 GS! And needless to say, everything that is needed to fit it is included in the delivery. TIP for perfect all-round protection: The perfect addition to the crash bar is our crash bar extension for the R 1200 GS (045-5161/5163). Also suitable for special model R 1200 GS „Rallye“ with special equipment „sports suspension“.

038-5160

038-5162 black

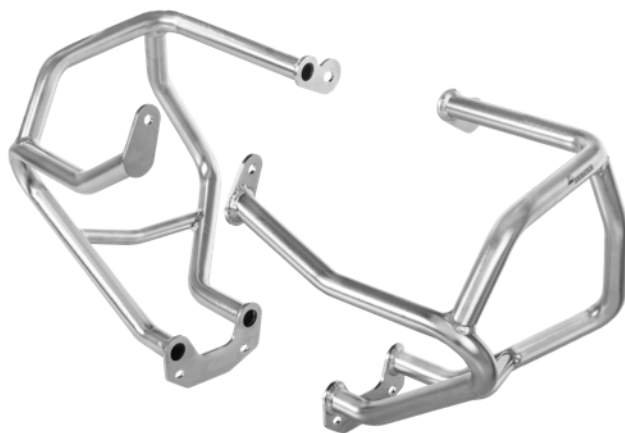



## Guard

### original BMW R 1200 GS Adventure (LC)

The screen adds fresh wind to the overall look of your motorcycle. It was specially adapted with clearance of the protection guard in mind and clearly improves its design.

It not only looks good but also increases the protective effect of the guard.

A total of 3 screw clamps fixate the screen and provide excellent stability. Damage through stones or scratches is prevented successfully.

045-5166 silver

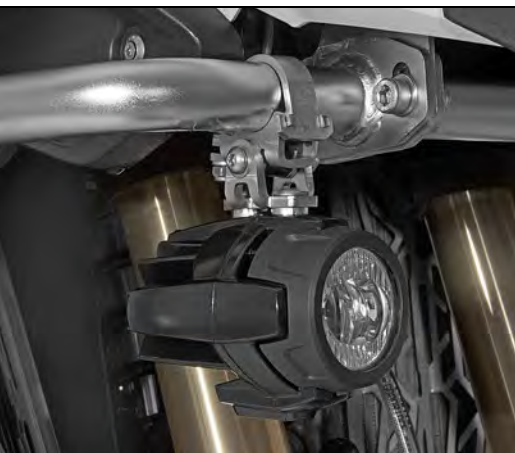

## Adapter kit for original BMW LED auxiliary headlights

045-5200





## Stainless Steel Crash Bar Extension

BMW R 1200 GS (LC) / Adventure (LC)

The Touratech crash bar extension protects the delicate radiator, the fairing and even the tank of the new water boxer! Even though BMW has fitted the radiator as closely as possible to the R1200GS, its bottom corners still protrude quite a lot. A bad drop can be all it takes to put paid to a trip – and you can expect a large bill for repairs. The Touratech crash bar extension will put an end to annoying scratches on the fairing! Made exclusively of strong, electropolished stainless steel, the extension will not rust. Even deep scratches are less frightening, and can simply be ground off.

Fitting the crash bar extension onto the Touratech engine guard or the original BMW engine guard is simple and straightforward.

045-5161 (2013–2016)

045-5165 Adventure (2014–)





### Stainless steel reinforcing strut for original BMW engine crash bar

The BMW engine crash bar on the water-cooled R 1200 GS isn't a proper crash bar until you fit the Touratech reinforcing strut! The additional supporting point is the key to providing maximum safety.

In terms of design and appearance, it perfectly matches the BMW engine crash bar on the GS since it is the same diameter and has an electropolished surface. Made from sturdy 25 mm stainless steel tube, the reinforcing strut is very easy to fit thanks to a new fastening system. The Touratech reinforcing strut provides lots of additional benefits at little cost or effort!

#### BMW R 1200 GS (LC) / Adventure (LC)

Usable without 045-5165

045-5164 (2013–2016) / ADV (2014–2016)

Usable with 045-5165

045-5170 (2013–2016) / ADV (2014–2016)

Usable with and without 045-5165

045-5169 (2017–) / ADV (2017–)

#### BMW R 1250 GS / ADV\*

037-5164

\*Not suitable for "Option 719" Cylinder cover.

037-5164



045-5164







### Stainless steel cylinder guard for original BMW engine guards

BMW R 1200 GS (LC) (2013–2016)

BMW R 1200 GS Adventure (LC) (2014–07.2016)

The stainless steel Touratech cylinder guard is the ideal complement to the original BMW engine guard as it closes the gap between the pipes.

For example, this prevents sharp stones from hitting and damaging the valve cover.

Made from 2mm thick stainless steel and intrinsically strengthened with beads and curves, the stainless steel cylinder guard can withstand the toughest conditions. It has been optimized further by replaceable plastic scrubber pads.

Fitting is easy with the clamping mechanism.

A technically intelligent accessory and real visual „highlight“ for your R 1200 GS/GSA!

045-5134





037-5130

037-5169

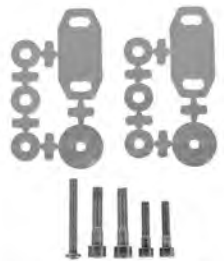

037-5132



## Cylinder protection (set)

BMW R 1250 GS | R 1250 R | R 1250 RS | R 1250 RT

Complete the sporty adventure look of your boxer and effectively protect the exposed cylinders! Whether it's a bump when manoeuvring in a narrow garage, a rock fall on the motorway or a fall after a strenuous stage - the cylinders of the BMW Boxer are quickly scratched. In the worst case, the valve cover even gets a hole and the journey is abruptly ended. The complex construction of the shiftcam mechanism of the R1250 series in particular requires special protection. Our developers have designed this cylinder protection especially for this purpose. The unique design of the stainless steel part guarantees effective protection, high stability and gives your BMW a sporty, modern look. The stainless steel/ aluminium protector encloses your cylinder like a protective sheath. Thanks to the well thought-out design, the forces are kept away from the valve cover in case of a fall. An impact with expensive consequences turns into a slide with a small scratch on the protector. In a set for both sides. For combination with the Touratech crash bars 01-037-5160-0 and 01-037-5162-0, we recommend to use 01-037-5169-0. For combination with the original BMW engine guards (R 1250 GS Adventure), please remove its rubber element.

037-5130 stainless steel

037-5131 aluminium

037-5132 aluminium black

037-5169 expansion kit crash bar

037-5131







045-5131



## Cylinder Protector, Aluminium

### BMW R 1200 GS (LC)

Easy to fit + lightweight + high level of protection

We accepted these challenges, and the result is a cylinder protector that meets all these criteria! Made of 3 mm aluminium and with specific attachment points, the Touratech cylinder protector can cope with R 1200 GS „drops“ as well as tougher impacts. Now there's an end to scratches - and even worse damage - to valve covers.

Tested in Madagascar as well as various other locations, the protector has more than proved its abilities.

A „must“ for any boxer engine with wide cylinders!

- Can be mounted along with the Touratech stainless steel crash bar 045-5160
- Made of 3 mm silver anodised aluminium
- Easily and quickly fitted.

What's included:

Cylinder protectors right + left, fittings, instructions

**045-5130** natural aluminium

**045-5131** black aluminium



## Cylinder protector for original BMW crash bars

### BMW R 1200 GS (LC) (2013–2016) / Adventure (LC)

- can be mounted along with original BMW crash bars

**045-5132** natural aluminium

**045-5133** black aluminium



## Heat Protection Shield Front Manifolds

BMW R 1200 GS (LC) / Adventure (LC)

Due to the position of the R 1200 GS boxer engine, unlike on other motorbikes, the manifolds are far over to the outside, completely free and exposed. Travelling over rough and smooth, there is always a risk of scratching a manifold on something or getting stuck. The consequences - dents, scratches or, in the worst case scenario, holes. We have the solution: the heat protection shield by Touratech provides optimum protection for the manifold. A useful and inexpensive accessory that usually pays for itself the first time it's used. This heat shield is made from laser-cut stainless steel. The design blends perfectly with the overall look of the new R 1200 GS. Very simple, fast and secure mounting.

045-5065 (2 pieces)



## Rear Brake Fluid Reservoir Guard

BMW R 1250 GS / ADV / R 1200 GS (LC) / ADV (LC)

On the BMW the brake fluid reservoir is all too easily accessible, putting it at risk of damage or tampering. Made from laser-cut aluminium, Touratech's brake fluid reservoir guard effectively prevents damage and undesired access to the reservoir lid, yet you can still easily see the fluid level. The guard simply bolts onto the existing mounting point.

045-5030



**Stainless Steel Radiator Protector**

BMW is going to rely on water cooling in new boxer engines as well from 2013. This means that optimum performance can be combined with a long service life. With its technically perfect implementation, the system has just one weak point: the sensitive radiator.

The Touratech radiator protector shields the vulnerable lamellae of the radiator against damage and thus provides an enormous safety benefit! The dread of flying stones, sticks or other debris

will be no more. A small investment will make your trip a whole lot safer!  
 Optically unobtrusive yet in the unmistakable Touratech-style, the radiator protector made of laser cut, stainless steel blends in with the R 1200 GS design perfectly.  
 Parts supplied: 2 parts (left and right).

**BMW R 1250 GS / R 1200 GS (LC) / ADV (LC)**

**045-5014**

**045-5013 black**

**BMW R 1250 GS / ADV**

**037-5016**

**037-5015 black**

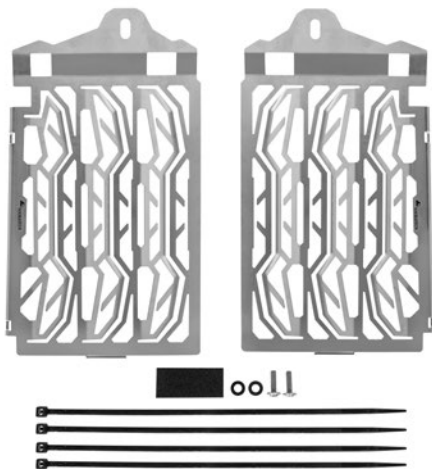

037-5016



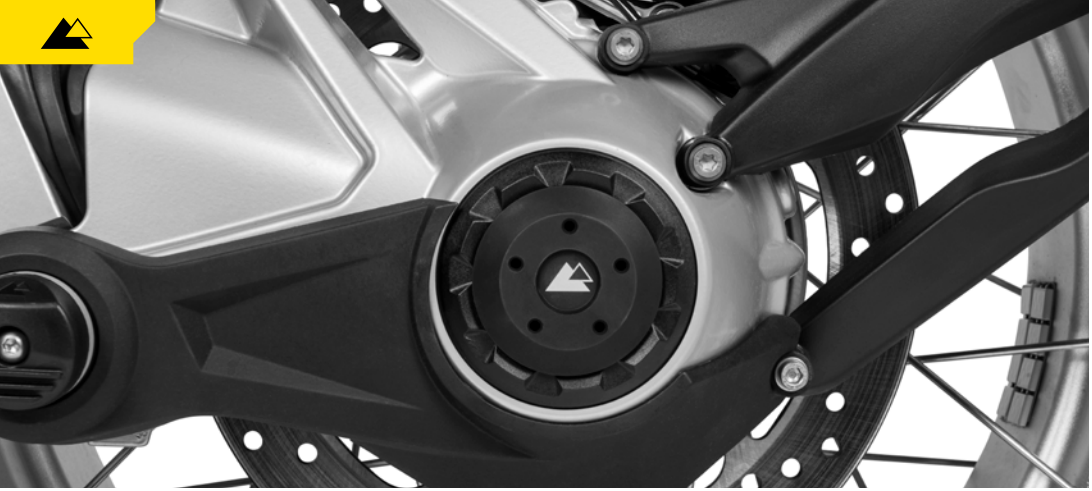

### Wheel hub cover

BMW R 1250 GS / ADV / R 1200 GS (LC) / ADV (LC)

The Touratech wheel hub cover is made from high quality anodised aluminium, and the classy laser inscription adds stylish accents.

In addition, it provides effective protection for the hub of your valuable GS.

045-5675



### Relocation Cardan Ventilation

BMW R 1250 GS / ADV / R 1200 GS (LC) / ADV (LC)

Riding a GS through deep water - no problem. Unfortunately not!

A small and inconspicuous valve at the cardan housing ensures the necessary ventilation and pressure exchange. If the valve gets dipped under water, moisture can get into the housing and damage the whole drive. The solution of the problem: relocating the cardan ventilation valve to a protected position. Due to two robust connectors made of lathed aluminium and a durable hose, the valve will be repositioned in a very easy way.

A MUST HAVE for every long-distance journey!

045-5506







## Cardan Guard

**BMW R 1250 GS / ADV / R 1200 GS (LC) / ADV (LC)**

The exposed rear axle housing is subjected to extreme loads when riding off-road. We have developed the perfect protection to prevent scratches and stone damage, as well as more serious damage, when riding over scree or other obstacles. It is made of impact-resistant, fibreglass-reinforced plastic, and wraps itself around the cardan housing like a protective hand. Needless to say, we have allowed for BMW's proposed cooling air supply, and have left a corresponding opening on the underside at the front. And furthermore, our cardan guard will also give your R 1200 GS an unmistakable, individual look!

- Made of fibreglass-reinforced PU
- Easy to fit
- Maximum protection
- Low weight
- Fascinating looks
- Repellent effect even with branches and loose stones

Colour: black

045-5500



## Cardan Crash Bung

**BMW R 1250 GS / ADV / R 1200 GS (LC) / ADV (LC)**

A little item that prevents big damage!

Sadly, the cardan housing of your R 1200 GS can suffer serious scratching and other damage even if it just falls over when stationary. If such a mishap occurs off-road, scree and dirt can even damage the rear axle seal, and in the worst case leaking oil can prevent you from travelling further.

Fitting this highly resilient, beautifully shaped crash bung in time can eliminate this danger - and prevent the expensive consequences!

045-5505

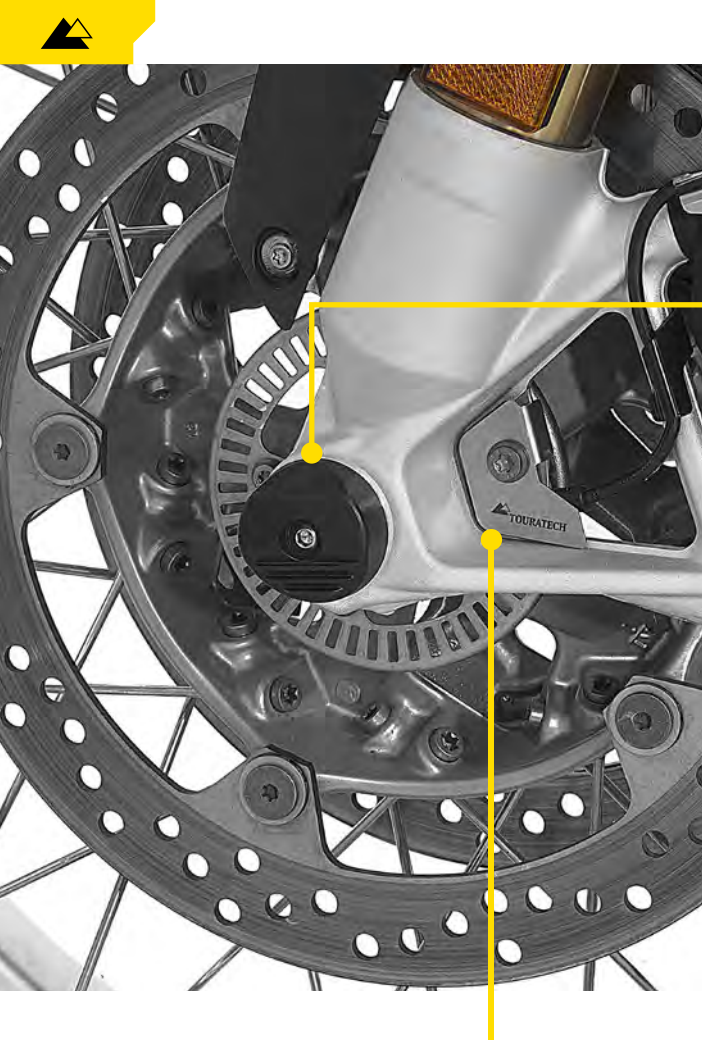

### Front axle crash bung (set)

BMW R 1250 GS / ADV /  
R 1200 GS (LC) / ADV (LC)

To complement our cardan crash bungs, we also offer crash bungs for the front axle of your GS. These small but effective parts efficiently protect the critical points of your bike and prevent damage to your fork legs and axle seats in the event of tipping over. Available as a set for both sides.

045-5507



### ABS sensor protection, front

BMW R 1250 GS / ADV /  
R 1200 GS (LC) / ADV (LC)

ABS cannot function without information about the wheel speed. Proper protection for the sensitive wheel speed sensors is therefore essential, especially on machines that often travel on rough ground.

The shapely guard made of stainless steel protects the front ABS sensor from coarse dirt and stones.

045-5005

## Protector for brake callipers front (Set)

BMW R 1200 GS (LC) / Adventure (LC)

Protects the brake callipers against damage and is a treat for the eye!

The strong, laser-cut aluminium guard takes just moments to fit.

045-5497 silver



R 1250 GS / ADV | R 1200 GS / ADV (LC)



## Brake Calliper Cover (Set) Front

BMW R 1200 GS (LC) / Adventure (LC)

Just a few years ago, an elegant cover over the callipers was included in the standard fittings on many motorbikes when they left the factory. Unfortunately, though, all searches for this protective and attractive cover for the R 1200 GS have proved futile. And yet it not only hides the often ugly individual components of the brake, but also stops the aggressive brake dust from settling on the rims and protects the brakes against rain and salt water, pebbles and dirt. Our covers are made of PU, come as an easy-to-fit set, and make sure that the front brake system of your GS looks good - a beautiful accessory elegantly covering the very technical brake calliper.

045-5172 black

045-5173 red







## Large Frame Guard

BMW R 1250 GS / ADV / R 1200 GS (LC) / ADV (LC)

Maximum protection for any conditions!

Our small frame guard is already pretty impressive in effectiveness. But anyone who wants more protection for the entire vulnerable foot peg/frame area should opt for this larger version in order to prevent paint wear and damage to the frame. This is achieved by means of a precisely fitting plastic cover that fits over three main frame pipes, the area around the swingarm bearing and the front bolted fixtures of the paralever strut to provide

the optimum protection against wear and dirt.

Combined with the easiest installation and perfect, precisely fitting design!

- Made of impact resistant plastic
- Tough, and able to cope with just about anything
- Lightweight and thermally stable
- Fitting as easy as ABC
- Perfect damage protection for the grid frame

Colour: black

045-5035 left

045-5036 right



## Small Frame Guard

BMW R 1250 GS / ADV / R 1200 GS (LC) / ADV (LC)

Perfect protection for the frame of the GS - and preserves its value! Years of experience have taught us that it is essential to protect the painted frame pipes around the area of the boots. Sadly, the paint in this area is unable to cope even with the normal amount of stress that occurs when touring and wearing road boots. The frames of bikes whose riders often ride standing up, wear enduro boots or ride off-road soon become unsightly because the paint is rubbed off, leaving the unprotected frame pipes exposed to all sorts of destructive influences.

045-5037 left

045-5038 right



### Cover for butterfly valves (Set), black BMW R1250GS / R1200GS (LC) (2017-)

The part that BMW missed to add!

The butterfly valve cover blends harmoniously into the bodywork of the BMW R 1250 GS / R 1200 GS (LC) from 2017 onwards. Easy to install with two screws, the panel covers the butterfly valve body elegantly. Look and feel of the product correspond with the high-quality appearance of the surrounding BMW Plastics.

As standard in black, the panel made of super-light polyamide can also be painted in color to create an interesting visual accent.

037-5495



Without cover



### Side cover (set)

BMW R 1250 GS / ADV / R 1200 GS (LC) / ADV (LC)

The high quality material mix of plastic and stainless steel combines stability, light weight and individual look. Produced with precision machinery, these protective parts fit exactly and are easy to install. Available as a set for both sides.

045-5438



### Set Side Covers + Small frame guard

BMW R 1250 GS / ADV / R 1200 GS (LC) / ADV (LC)  
(Set Left and Right)

045-5437



### Number Plate Splash Guard

BMW R 1250 GS / ADV / R 1200 GS (LC) / ADV (LC)

This black anodised splash guard is mounted behind the number plate bracket and extends it both downwards and towards the rear of the bike. It therefore effectively prevents dirt and other debris from soiling or damaging your seat, clothing, or luggage.

The aluminium splash guard also stabilises the

number plate and prevents it working loose due to vibration.

Made of black anodised aluminium.

045-5000 GS

045-5001 ADV

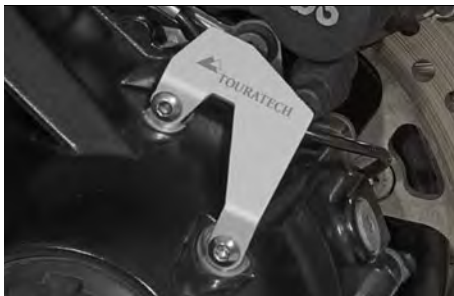

### Hub cap cover

BMW R 1250 GS / ADV / R 1200 GS (LC) / ADV (LC)

You can use this panel to cover the fastening points of the rear wheel cap if you want to dispense with the wheel cap.

(Off-road use, appearance)

- Made from 2 mm aluminium
- Natural anodised

045-5265 silver

045-5266 black



## Protection exhaust flap

BMW R 1250 GS / ADV / R 1200 GS (LC) / ADV (LC)

An elegant and protective eye-catcher.

The exhaust flap on the R 1200 GS is almost unprotected. This protection is made from anodized aluminium. It fits slickly into the overall appearance of the BMW and protects the exhaust flap against damage.

Simply attaches using the original fixing materials.

045-5080 silver

045-5081 black



R 1250 GS / ADV | R 1200 GS / ADV (LC)



## Protection for flap control

BMW R 1250 GS / ADV / R 1200 GS (LC) / ADV (LC)

Protects the flap control against damage and is a treat for the eye!

The strong, laser-cut aluminium guard takes just moments to fit.

045-5082 silver

045-5083 black



## Protection for starter

BMW R 1250 GS / ADV / R 1200 GS (LC) / ADV (LC)

Protects the starter against damage and is a treat for the eye!

The strong, laser-cut aluminium guard takes just moments to fit.

045-5311    **black**

045-5312    **aluminum**



## Decal Set

BMW R 1250 GS / ADV / R 1200 GS (LC) / ADV (LC)

Absolutely strong, thick film protects against stones and other types of damage. Very easy to apply - strong adhesive.

100-0508    Fork            (2013–2016)            (for both sides)

100-0509    Fork            (2017–)                (for both sides)



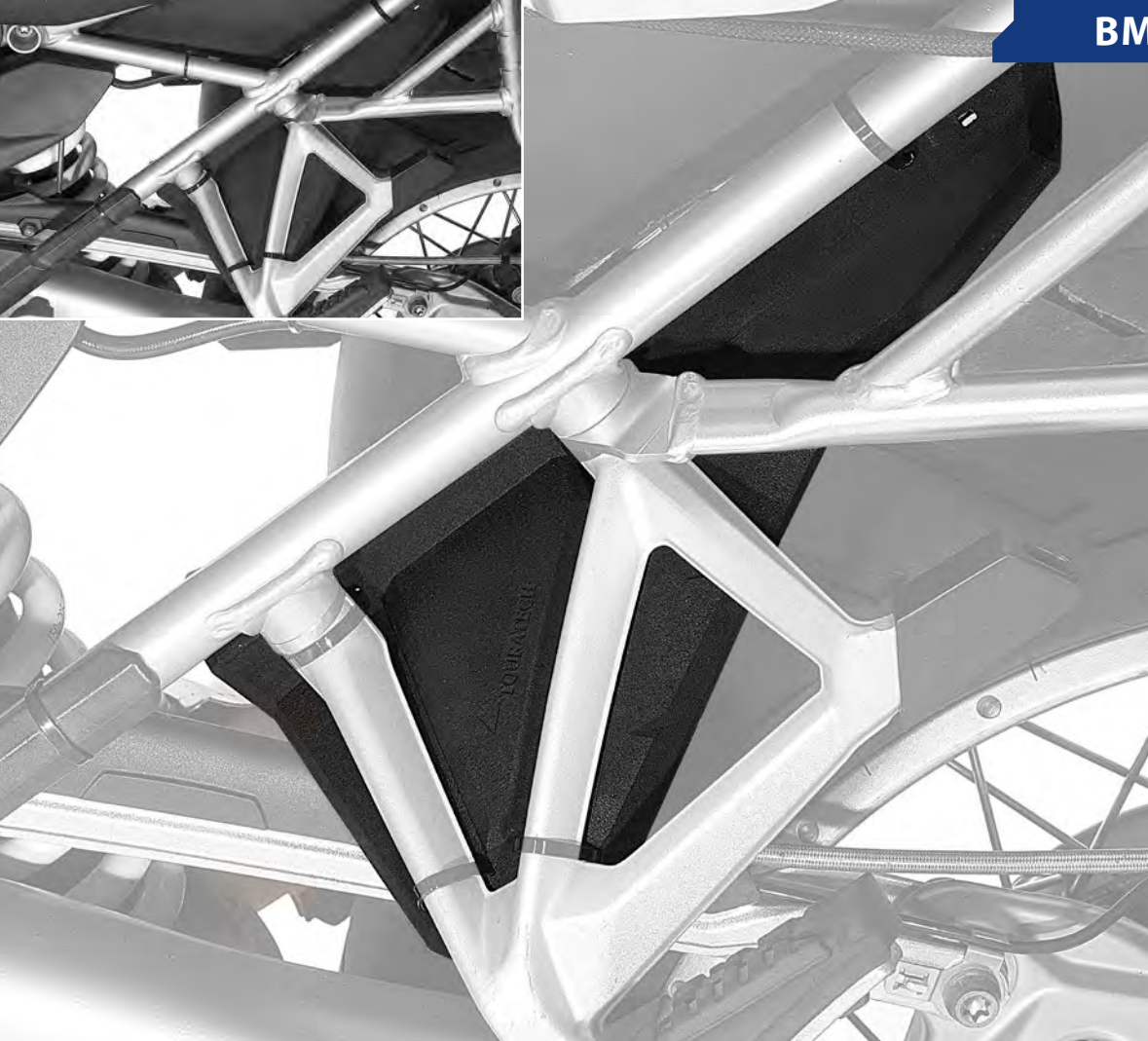

### Passenger footpeg splash guard (set)

BMW R 1250 GS / ADV / R 1200 GS (LC) / ADV (LC)

When driving in the rain, the rear wheel often flings the dirt and the water up your boots and legs. These high quality and super lightweight plastic parts prevent this happening and look great into the bargain. Available as a set for both sides.

045-5440



## Mudguard Extension

### BMW R 1250 GS / R 1200 GS (LC)

When riding on wet roads of off-road, the rider instantly notices how little splash protection the GS has to offer! Dirt and water are spun away to the front, and then pushed back against the upper body by the airstream. This effect is dramatically reduced by the extension for the front upper mudguard. The front of the vehicle and the rider's visor stay clean for longer, and stones and scratches are minimised!

Furthermore, the mudguard extension visually changes the vehicle's looks towards the „Adventure“. In fact, the very distinctive mudguard of the R 1200 GS | R 1250 GS is not to everybody's taste and looks a lot better with our extension - the GS is given a sporty, individual appearance that you too will love!

- Made of tough, highly resilient PU
- Easy to fit
- All materials included in the delivery
- Continues the design and style of the R 1200 GS | R 1250 GS
- Elegant matt black finish
- Subtle Touratech logo at the front.

Colour: black.

045-5445 (2013–2016)

038-5445 (2017–)





045-5315



045-5316

### **WORKS Long-Distance Foot Pegs, with ABE**

**BMW R 1250 GS / ADV / R 1200 GS (LC) / ADV (LC)**

- 52 mm wide and 4 mm thick stainless steel claw profile that is kind to your boots
- Perfect combination of grip and self-cleaning
- With a more slender design for better ground clearance
- Significantly less susceptible to impacts
- Strengthened mounting point
- With a blasted surface and laser inscription for a superior finish

045-5315

045-5316 \*low\* -20 mm



## Pivot Pegz MK4

BMW R 1200 GS (LC) / ADV (LC) | R 1250 GS ADV

Pivot Pegz MK4 now with 6 cm wide and 10 cm long tread for even better grip!

Thanks to a spring joint, these foot pegs follow the forward and backward movements of the foot to an angle of 20 degrees. This protects the boot, and gives the Rider a better position on the bike - even in extreme situations.

040-5521

040-5525 **Toppers**



040-5525



TOURATECH  
**NEW  
PART**

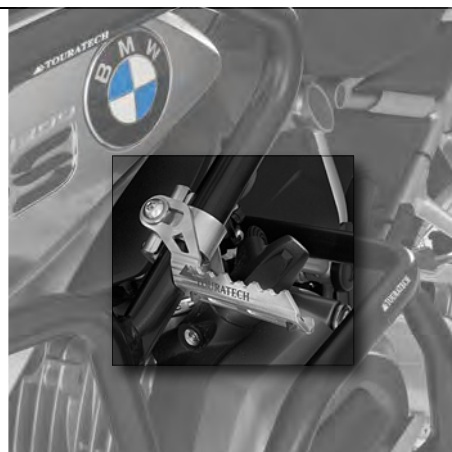

## Highway Pegs

BMW R 1200 GS (LC)

Finally - a way to relax your legs on long journeys! These motorway pegs are additional folding foot rests that let you stretch out your legs into a more comfortable position while riding. They make long runs a breeze. Touratech motorway pegs provide optimal grip even for heavy cross boots, thanks to their serrated surface developed in enduro racing.

They fold up close to the tube, taking up little space - an obvious advantage if things get tight during an off-road excursion. With their special attachment mechanism, they are an ideal accessory on the Touratech fairing crash bar for the BMW R 1200 GS, 2013 onwards (045-5161), see p. 47.

045-5317

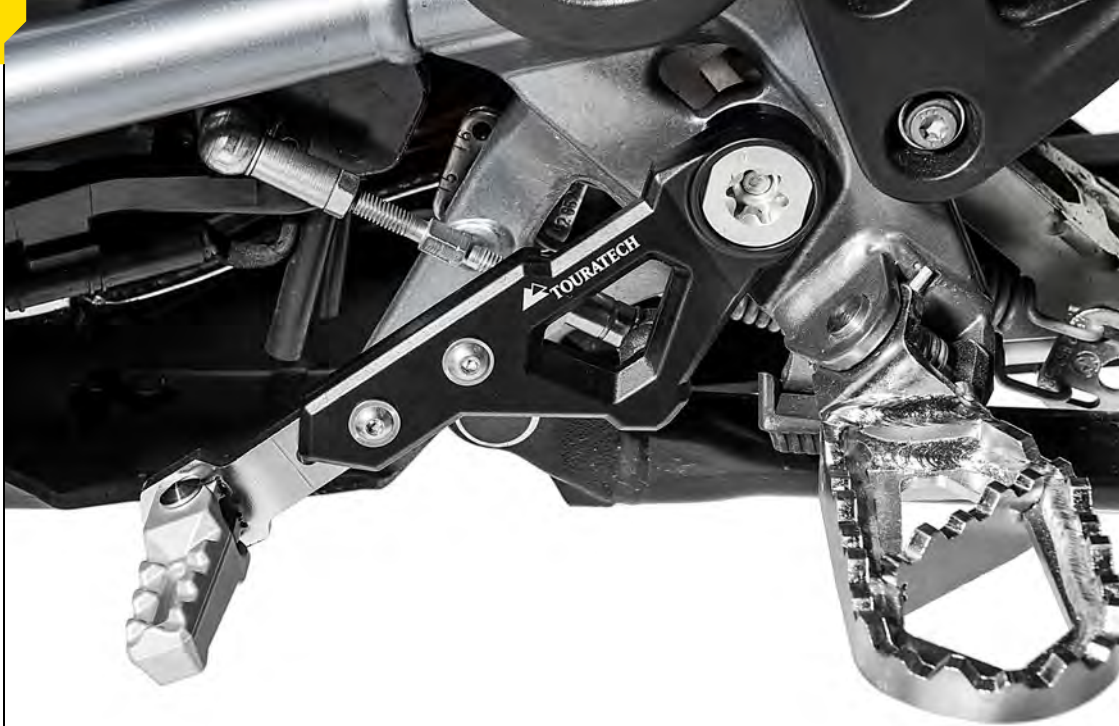

### **Gear lever length adjustable and foldable**

**BMW R 1250 GS / ADV / R 1200 GS (LC) / ADV (LC)**

Often it is just little things that are necessary to achieve the optimum ride experience. Take the original GS gear lever, for instance, the height could be adjusted but not the length. The Touratech gear lever can be adjusted to your foot precisely and, due to being foldable, doesn't break off every time you tip over either. In addition, this gear lever, made from a high quality aluminium stainless steel material mix, optically upgrades your GS!

Adjustment range: 32 mm

**045-5405**







### Stainless Steel Folding Brake Lever

BMW R 1250 GS / ADV / R 1200 GS (LC) / ADV (LC)

The brake lever can break even if you just fall. This will make it very difficult, if not impossible, to go any further. With our stainless steel brake lever you can reduce this risk easily and effectively because of the folding back end. The lever is adjustable in several ways to fit every foot and riding style. Compared to the original lever the Touratech folding brake lever can be adjusted in length by +5/-5 mm and in height by +4/+10 mm. This makes braking while standing up a lot easier. For extreme off-road use you can also attach a catch-rope.

Note:

The Touratech folding and adjustable brake lever in lower position is situated 13 mm higher regarding the original break lever height.

045-5395





TOURATECH

## Side stand base extension

BMW R 1250 GS / R 1200 GS (LC) 2013 and from 2017

045-5275

## Side stand base extension, wide shape

BMW R 1250 GS / ADV / R 1200 GS (LC) / ADV (LC)

It's a familiar problem that has tested the temper of many motorcyclists. After riding your bike along rocky, bumpy off-road tracks, you just want to stop for a rest. But that's easier said than done. Parking your bike on soft ground can be a real problem! Usually you can't find a wooden board or something similar to stand the bike on when you need it. Touratech has the solution: the side stand base extension more than doubles the area of the supporting surface, so you won't find yourself straining to lift the fully laden machine. A mix of stainless steel and black anodised aluminium components ensure the base extension looks good and provide full stability.

Securely fixed to the side stand, the base extension is a useful accessory that is always there to save you a lot of hassle and frustration.

045-5276 suitable for special model R 1200 GS „Rallye“ with special equipment „sports suspension“ and R 1200 GS ADV from 2014.

045-5276 2014-2016 + R1250GSA

045-5277 2014-2016 lowering kit

037-5277 R1250GS+GSA lowering kit

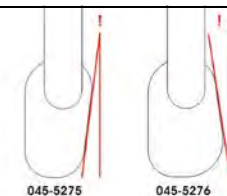

## Side stand switch protector

BMW R 1250 GS / ADV / R 1200 GS (LC) / ADV (LC)

If the side stand switch stops working, the ignition cuts out and it's the end of the trip for your GS.

The Touratech side stand switch protector perfectly shields this absolutely vital component. Neither your boot tips nor twigs or stones can do it any damage.

045-5105 (2014-)





## FRESH TOUCH

The high quality, multi-layer seat cover is equipped with a durable Fresh Touch surface coating. It reduces the surface temperature by significantly reflecting infrared light radiation and providing a cooler feeling when mounting a motorcycle parked in the sun. An additional, exclusive gain in comfort for your riding pleasure!



## Comfort Seat FRESH TOUCH

BMW R 1250 GS / ADV / R 1200 GS (LC) / ADV (LC)

There are many ways to significantly improve the comfort and long-distance suitability of the standard seat on the new GS! For example, increasing the surface area of the seat is top of the wish lists of many riders and passengers. We provide the desired level of comfort by producing a larger, anatomically shaped foam core together with our own plastic base pan. The seat is perfect over long distances thanks to its high-quality, non-slip, bi-elastic covering material that provides a sweat-resistant surface. Of course these seats also feature proven Touratech optimisations such as a hollowed recess to relieve coccyx pressure, a special contour on the pillion seat surface for support while braking and accelerating, and perfect positioning of the seams. The extremely useful ability to adjust the seat angle and move the pillion seat is retained with our seats. All in all a great investment in the future of your GS! This high quality seat is supplied complete and ready-to-fit. There is no delay waiting for reupholstery work. It does not require any modifications to your motorbike and simply replaces the original seat, which you can keep.

045-5949	extra low (-3 cm)
045-5950	low (-2 cm)
045-5951	standard
045-5952	high (+2 cm)
045-5957	pillion

**Our rider and pillion seats  
can only be used together  
on the Adventure!**

## We also offer this popular comfort seat in our patented breathable version for the most discerning riders!

The seat construction is based on an open-pored foam core with a spacer fabric around the seat to allow air to flow more easily through the ultra strong, elastic, waterproof textile cover.

The result of this elaborate construction is overwhelming, and guarantees maximum riding comfort not only on long rides, but also at high outside temperatures and in extreme humidity. And yet there are no disadvantages or restrictions in normal every day use.

## Comfort Seat BREATHABLE

045-5904	standard
045-5905	high (+2 cm)
045-5910	pillion





## Single-Piece Sports Seat FRESH TOUCH

**BMW R 1250 GS / ADV / R 1200 GS (LC) / ADV (LC)**

Developed by Touratech, the highly resilient, precision fitting seat base pan is topped with a single-piece high-strength foam core and finished with a tear-resistant, sweat-resistant, bi-elastic seat cover. The seat is designed to allow quick reactions when needed. The optimised contours of the seat surfaces and the ability to easily adjust the seating position mean that longer journeys are now also a breeze. Despite this being a rider-oriented seat, it provides sufficient space for two people and contact between rider and passenger is actually improved as a result of the single-piece design. Not least, this single-piece sports seat gives the R 1200 GS an exclusive, customised look.

This high quality seat is supplied complete and ready-to-fit - there is no delay waiting for reupholstery work. It does not require any modifications to your motorbike and simply replaces the original seat, which you can keep.

### Features:

- Anatomically shaped based on extensive test riding in Germany
- Our proprietary high-strength foam provides superior cushioning to prevent pressure sores
- Even weight distribution plus optimised contact with the bike equals perfect control
- Bi-elastic, sweat-resistant covering material with sealed seams
- HOLLOWED RECESS in the middle of the seat relieves coccyx pressure
- Available in different heights
- Seams are optimally positioned to avoid creating pressure points on the seat
- Suitable for long-distance touring
- Top quality materials manufactured to the highest standards
- Made in Germany.

### Single-Piece Sports Seat

045-5962	low (-2 cm)
045-5963	standard
045-5964	high (+2 cm)

### Single-Piece Sports Seat BREATHABLE

045-5916	standard
045-5917	high (+2 cm)



## Progressive replacement springs for front and rear shock absorber

BMW R 1250 GS / ADV / R 1200 GS (LC) / ADV (LC)

This Set of progressive replacement springs has been designed to match the BMW R 1250 GS & R 1200 GS perfectly, and offer a "tremendous improvement" in response and greater safety in extreme situations. Replacing the front and rear springs will lead to a significant improvement and more riding pleasure with your motorbike.

<b>045-7439</b>	R 1250 GS / R 1200 GS (LC) (2013-2018)
<b>045-7440</b>	R 1250 GS / R 1200 GS (LC) (2013-2016) ESA
<b>045-7441</b>	R 1250 GS / R 1200 GS (LC) (2017-2018) ESA
<b>045-7442</b>	R 1250 GS / R 1200 GS ADV (LC) (2014-2017)
<b>045-7443</b>	R 1250 GS / R 1200 GS ADV (LC) (2013-2017) ESA

## Replacement springs lowering kit -20 mm

BMW R 1250 GS / ADV / R 1200 GS (LC) / ADV (LC)

The height lowering replacement springs has been designed to match the BMW GS perfectly This spring set provides you with a -20 mm reduction in height without affecting the riding properties – at the expense of a little ground clearance. The progressive springs have been designed to match the original shocks BMW GS perfectly, and offer good response and safety in extreme situations. The balance of your motorcycle remains fully intact.

<b>045-7444</b>	R 1200 GS (LC) (2013-2016) ESA
<b>045-7445</b>	R 1250 GS / R 1200 GS (LC) (2017-) ESA
<b>045-7446</b>	R 1200 GS ADV (LC) (2014-2017) ESA
<b>037-8000</b>	R 1250 GS ADV (2018-) ESA



# TOURATECH SUSPENSION



## SEMIACTIVE

FULLY SERVICEABLE.

NO ERROR MESSAGE  
ON THE BMW DISPLAY.

Additional high and low speed damping for the entire setup.

The world's first suspension purpose-built for adventure touring motorcycles with luggage

Unique patented DDA high-performance solenoid valve developed by Tractive.

Uniquely, solid, hydraulic spring pre-load, controlled via the original BMW control unit.

Also for BMW R1250GS  
Dynamic ESA Next Generation  
For more information, please visit  
[www.touratech-suspension.com](http://www.touratech-suspension.com)

Connects to the original BMW plugs.



- This premium suspension system is systematically designed for long-distance touring with lots of luggage, on any type of road surface – and even off-road.
- The Plug & Travel suspension system is manufactured using the same precision components and parts that have been tried-and-tested in our shock absorbers over thousands of miles of touring, under the most intense conditions.
- Our semi-active Plug & Travel suspension system does not isolate your motorcycle from the ground.
- You always have perfect feedback from the suspension plus our specially tested Touratech setup for your BMW R 1250 GS / R 1200 GS.
- Touratech Suspension Plug & Travel shock absorbers simply replace the BMW DDC shocks.
- The existing plug connectors and switches on the handlebar are retained and used as usual.
- The Touratech Plug & Travel suspension system



becomes an integral part of your motorcycle via the original BMW control unit.

- All riding modes and configurations are accessed in the usual way and appear on the BMW cockpit display.
- **This Touratech suspension system adapts itself to the adventurer inside you – so all you have to do is ride!**

**Touratech Suspension shock absorber DDA / Plug & Travel**

	front	rear	Set
BMW R 1200 GS (LC) (2013–2016)	045-5883	045-5884	045-5885
BMW R 1200 GS ADV (LC) (2014–2016)	045-5873	045-5874	045-5887
BMW R 1250 GS BMW R 1200 GS (LC) (2017–)	045-5863	045-5864	045-5865
BMW R 1250 GS ADV BMW R 1200 GS ADV (LC) (2017–)	045-5859	045-5860	045-5861

**Lowering kit SET DDA / Plug & Travel**

BMW R 1200 GS (LC) (2013–2016)	-50 mm	045-5886
BMW R 1200 GS ADV (LC) (2014–2016)	-40 mm (ADV)	045-5888
BMW R 1200 GS ADV (LC) (2014–2016)	-25 mm (ADV)	045-5889
BMW R 1250 GS BMW R 1200 GS (LC) (2017–)	-50 mm	045-5862
BMW R 1250 GS ADV BMW R 1200 GS ADV (LC) (2017–)	-25 mm (ADV)	045-5866
BMW R 1250 GS ADV BMW R 1200 GS ADV (LC) (2017–)	-40 mm (ADV)	045-5867



## The **EXTREME SUSPENSION** for your BMW R 1250 GS / R 1200 GS **WITHOUT THE DDC** system

The Extreme suspension system for the BMW R 1250 GS / R 1200 GS (LC). The name says it all.

This suspension system for the BMW R 1250 GS / R 1200 GS (LC) enhances stability and comfort for greater safety and riding enjoyment even over thousands of miles of the harshest off-road terrain. A suspension system that is uncompromisingly tuned for hard touring use.

The required settings are made by hand, and the motorcycle is balanced according to the load. The hydraulic position-dependent damping system (PDS) ensures that the spring elements will not bottom out even with heavy luggage in the most extreme off-road conditions.

**Touratech Suspension EXTREME front**

**045-5876**

for BMW R 1250 GS / R 1200 GS (LC) (2013–2017)

**Touratech Suspension EXTREME rear**

**045-5870**

for BMW R 1250 GS / R 1200 GS (LC), (2013–2017)

**Touratech Suspension EXTREME front**

**045-5877**

for BMW R 1250 GS / R 1200 GS Adventure (LC) (2014–2017)

**Touratech Suspension EXTREME rear**

**045-5871**

for BMW R 1250 GS / R 1200 GS Adventure (LC) (2014–2017)

**Are you planning to fit this Extreme suspension system to your BMW R 1200 GS (2013–2017), with DDC? It can be done.**

To avoid Dynamic Damping Control (DDC) error messages on the display after switching to a Touratech Suspension Extreme suspension system, Touratech has developed a disable plug (045-5879). This ensures that the riding modes ASC, ABS and DTC continue to operate perfectly.



ADVENTURE



## Touratech Suspension

# STEERING DAMPER

The stabilisation factor



The Touratech Suspension CSC steering damper effectively optimises ride stability – whether for off-road and touring use carrying a heavy load or while chasing curves. Trials and experience have shown that the linear Touratech Suspension CSC (Constant Safety Control) steering damper with its permanent assistive effect adds a whole new dimension to riding.

What the Touratech Suspension CSC steering damper does:

- No more hard steering when cornering slowly with a heavy load
- Minimised disturbances transmitted to the handlebar by the rider
- For example: wind flow over motorcycle clothing and turbulence caused by a truck or van in front
- Minimised instability caused by ruts on motorways, main roads and dirt tracks
- Small front wheel with knobbly tires is noticeably more stable when riding off-road or on sand
- Less fatigue on long journeys thanks to consistently greater ride stability

Fitting the CSC steering damper makes your bike's ride and handling significantly more stable, less tiring, and safer.

Always supplied complete with appropriate mounting kit for the motorcycle type.

- CNC-milled from high-grade 7075 aircraft aluminium
- Optimal response characteristics for maximum safety
- Elegant Touratech design and 75 mm stroke
- Individual damping adjustment through 24 clicks
- Road legal

**Touratech Suspension steering damper CSC**

**Currently available for the following motorcycle models:**

**BMW R 1200 GS (LC) 2013 with mounting kit**

**045-5830**

**BMW R 1250 GS / R 1250 GS ADV / R 1200 GS (LC) / ADV (LC)**  
(2014–)

with mounting kit

**045-5832**



## Stealth silencer, slip on, stainless steel black, all street legal

BMW R 1250 | 1200 GS (LC) / Adventure (LC)

Features:

- Carbon inlet and outlet cap
- Coat in „black“ Stainless Steel
- Core in stainless steel
- Asymmetric hexagonal jacket shape
- Dual system with removable sound insert
- Weight 2.84 kg
- Power and torque increase
- Supersound
- For original BMW or Remus manifold
- Including carbon heat protection
- Street legal

045-5857 (2017-)



## REMUS Black Hawk muffler slip on, stainless steel black, all street legal

BMW R 1200 GS (LC) / Adventure (LC)

Features:

- Carbon outlet cover
- Jacket in stainless steel, black
- Core in stainless steel

- Asymmetric hexagonal jacket shape
- Dual system with removable sound insert
- Increases power and torque
- Super sound
- Includes connecting tube for original or Remus manifold
- Street legal

045-5855 (2017-)



### Handlebar bag Ibarra Smart

Practical storage space and waterproof smartphone holder - always within reach!

The highlight of our "Ibarra Smart" is the waterproof compartment for all common smartphones (up to approx. 9x16 cm). Thanks to a small opening you can connect your charging cable.

Under the lid there is a large, weatherproof main compartment (approx. 2.4 litres) for first aid kits, high-visibility vests or sunglasses. A further, smaller compartment allows quick access to important documents and other small items. The yellow lining helps you to find the contents of the bag more easily.

A key feature is that our bag doesn't in any way restrict the rider's movements or affect control of the bike. The use of certified Cordura guarantees highest material quality.

Dimensions: (L x W x H) approx. 33/17 x 8 x 13 cm

Volume: approx. 2.4 litres

055-1285





## Tank Bag AMBATO PURE

BMW R 1250 GS / ADV / R 1200 GS (LC) / ADV (LC)

This minimalist tank bag is a practical, well thought out piece of equipment that represents outstanding value for money. Flatter in shape and with fewer adornments, this model is suitable for all kinds of uses. For instance, it provides enough space for a day trip, can hold documents, a mobile phone, wallet and drinks on the way to a city sightseeing tour, and is also the preferred choice for off-road riding as it doesn't restrict the rider's movements while standing or affect the bike's handling.

An ideal accessory providing excellent utility value at a great price.

- Vehicle-specific, precisely fitting base plate for secure, play-free attachment to the bike
- Insert panels made from strong waterproof tarpaulin
- The material that we use is not plain nylon - it is certified Cordura fabric, as also used for protective motorcycle clothing and expedition equipment
- Sturdy body and top made from high-quality, water-resistant and abrasion-resistant 1100 Dtex Cordura
- Waterproof coating on inside of fabric
- Fluorocarbon impregnation and Teflon coating by DuPont using nanotechnology for protection against moisture, dirt, oil and fading
- Washable and easy to clean
- The fabric used has been tested for harmful substances and certified in accordance with OEKO-TEX Standard 100
- Reflective 3M Scotchlite panels for maximum visibility

Size: (l x w x h) approx. 35 x 27 x 20 cm

Volume: approx. 9 litres

Colour: black

045-5802







045-5800



045-5825

### Tank bag AMBATO EXP / SPORT

BMW R 1250 GS / ADV / R 1200 GS (LC) / ADV (LC)

As we develop and offer the exclusive base plates and strong attachment kits for our robust tank bags for each specific vehicle, it is a given that a perfect fit with no play at all should be achieved!

The "AMBATO EXP" is also notable for the expansion option with an all-round zipper; small items can easily be stored under the adjustable elastic strap on the back. Thanks to the water-repellent cable hole, it's now easy to charge a mobile pho-

ne in the tank bag - plus the side pockets have an expansion pleat, which means there's even more room inside them than you would think.

You'll be extremely impressed by the long list of special features.

Size: (l x w x h) approx. 37 x 27 x 22/32 cm;

Capacity: approx. 13/20 litres.

**045-5800 AMBATO EXP - black**

**045-5825 AMBATO EXP Sport - black/white**



### Tank bag AMBATO EXP

BMW R 1250 GS / ADV / R 1200 GS (LC) / ADV (LC)

**045-5824 AMBATO EXP limited - red**

**045-5829 AMBATO EXP limited - yellow**





## Tank bag Ambato Exp HP

BMW R 1250 GS / ADV  
R 1200 GS (LC) / ADV (LC)

The Ambato Exp in  
BMW Motorsport colors!

Size: (L x W x H)  
approx. 37 x 27 x 22/32 cm  
Volume: approx. 13/20 litres

045-5803



### TANK BAG AMBATO EXP

As we develop and offer the exclusive base plates and strong attachment kits for our robust tank bags for each specific vehicle, it is a given that a perfect fit with no play at all should be achieved!

The Ambato Exp is also notable for the expansion option with an all-round zipper; small items can easily be stored under the adjustable elastic strap on the back.

Thanks to the water-repellent cable hole, it's now easy to charge a mobile phone in the tank bag - plus the side pockets have an expansion pleat, which means there's even more room inside them than you would think.



## Tank bag Ambato Exp Rallye

BMW R 1250 GS / ADV  
R 1200 GS (LC) / ADV (LC)

Size: (L x W x H) approx.  
37 x 27 x 22/32 cm

Volume: approx. 13/20 litres

045-5828



- Vehicle-specific, precisely fitting base plate for secure, play-free attachment to the bike
- Waterproof coating on inside of fabric
- Fluorocarbon impregnation and Teflon coating by DuPont using nanotechnology for protection against moisture, dirt, oil and fading
- Washable and easy to clean
- Reflective 3M Scotchlite panels for maximum visibility
- Strong, ergonomic carry handle for practical transportation away from the bike
- All-round zip for easy expansion
- Made for extreme loads and built to last
- Organiser with small inner pocket inside the top cover for toll cards, credit cards and loops for pens or a small torch
- Securely attached but can be quickly taken off

the bike

- Map pocket with Velcro fastener and large opening included
- Carry straps for use as a shoulder bag or rucksack are included
- Water-resistant, high-quality zips
- Reflective quick-release elastic straps for quickly stowing gloves or a rain jacket
- Practical, spacious side pockets with generous expansion flap
- Water-resistant cable grommet for a charging cable or other power supply

**Please note: Use paint protection film if necessary!** (Item number 01-101-0100-0)



## Tank Bag TOURING

BMW R 1250 GS / ADV / R 1200 GS (LC) / ADV (LC)

A timeless, classic design with proven features: That's what you get from our „Touring“ tank bag. With its large main compartment, two zippered outer pockets and a removable map pocket (DIN A4 size), this bag has exactly what you need for both small and large tours. If you should unexpectedly need more storage space, the volume of the bag can be readily increased by opening its central surrounding zipper. The included carrying straps allow it to be also quickly and easily used as a shoulder bag or backpack. Practical, high-quality and extremely durable!

Size: (l x w x h) approx. 35 x 26 x 18/25 cm.

Capacity: approx. 14/22 litres.

Colour: black

045-5801



## Rain cover for the tank bags

A very special rain cover!

Thanks to the rubber band, the rain cover can be lashed down in such a way as to substantially reduce the billowing out caused by the airflow.

High-class finish with a large visible map compartment.

055-1269

## Rain cover by Touratech Waterproof

055-3132 yellow

055-3133 black



## Tank bag IBARRA

BMW R 1250 GS / ADV / R 1200 GS (LC) / ADV (LC)

The „Ibarra“ tank bag has been specially designed for big trail bikes and large space requirements. With its foamed base plate, it sits precisely and securely on the tank. Thanks to a stable basic body made of high-quality textile fabric, the Ibarra retains its shape in all situations. The upper material is water-repellent and abrasion-resistant.

With its large main compartment, two zipped outer pockets and detachable map pocket in DIN A4 size, the Ibarra offers enough volume even on long tours. The expansion zip allows for additional storage space. The all-round zip provides easy access. Like all Touratech tank bags, the Ibarra can also be fitted or removed in seconds with click fasteners.

Elasticated straps with quick-release fasteners, YKK brand zips and reflective sections by 3M round off these high-quality features.

Dimensions: (L x W x H) approx. 35 x 26 x 18/25 cm;

Volume: approx. 14/22 litres.



055-1281



## Bags AMBATO for Crash bars / Crash bar Extensions

**A brilliant bag for rain suit, spare gloves etc.**

The bags are just put over the tank bracket and fixed in place with 2 straps. When you're planning a short trip out on your motorbike, it's often tricky to know where to put your map, something to drink, your waterproofs, a spare pair of gloves, even something to clean your glasses with. They're all things you need to have with you, and although they don't take up a lot of space, they won't usually fit in your jacket. A pannier system or rucksack is more than is required, and will only get in the way. Touratech has the solution in the shape of bags for the original crash bars. They have just the right amount of space, especially for those little things. The bags are sold in pairs, and fit on the original crash bar. They are simply placed over the bar and secured by two straps.

- The material that we use is not plain nylon – it is certified Cordura fabric as also used for protective motorcycle clothing and expedition equipment
- Waterproof coating on inside of fabric
- Fluorocarbon impregnation and Teflon coating by DuPont using nanotechnology for protection against moisture, dirt, oil and fading
- Washable and easy to clean
- The fabric used has been tested for harmful substances and certified in accordance with OEKO-TEX Standard 100
- Reflective 3M Scotchlite panels for maximum visibility
- Made for extreme loads and built to last
- Perfect fit
- Securely attached but can be quickly taken off the bike
- Low-weight bag with high carrying capacity and large usable volume



## Ibarra bag for original crash bar

BMW R 1250 GS Adventure

Fitted to the original crash bars of the Adventure, our elaborately designed bags offer additional storage space for all those small items that are needed in a rush. They are easy to mount with velcro straps, will take every load, can be removed easily if required, and match our other soft luggage solutions for the GS perfectly!

037-5840 1 pair Vol. 2 x 2 l



R 1250 GS / ADV | R 1200 GS / ADV (LC)

## AMBATO bags for original crash bar

BMW R 1200 GS Adventure (LC)

045-5839 1 pair Vol. 2 x 2 l

## Crash bar bags AMBATO for 045-5165 / 045-5165

BMW R 1200 GS Adventure (LC)

045-5834 1 pair Vol. 2 x 5 l



## Tank Side Bags AMBATO

BMW R 1200 GS Adventure (LC)

The perfect supplement to the tank bag! The two tank side bags provide additional storage space without restricting the rider's movement. In developing these bags, we ensured that they have a complementary shape that neither disturbs the smooth, modern lines of the bike nor interferes with the flow of cooling air. They also sit securely without fluttering and help to shield the rider during adverse weather conditions.

To achieve all this, it was necessary to make attachment kits specifically for these bikes. To provide the greatest possible flexibility, we made sure that these tank side bags can be attached both with and without our tank bags. This convenient design allows riders to easily create their own customized luggage solution

045-5835 Vol. 2 x 6 l





## Side bags for frame triangle

BMW R 1250 GS / ADV / R 1200 GS (LC) / ADV (LC)

Two bags that fit well and unobtrusively on the bike! The two side bags provide additional storage space without restricting the rider's movement. And, of course, we took care to ensure passenger suitability. The back of the bag is made of water and dirt repellent tarpaulin.

Size: (L x W x H) approx. 48 x 5 x 20 cm

045-5822



## Crash Bar Bags AMBATO

for 045-5168 / 045-5171 & 037-5161 / 037-5163

BMW R 1250 GS / R 1200 GS (LC) (2017-)

038-5816 1 pair

Vol. 2 x 3 l





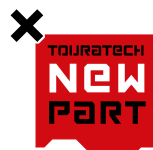

## Touratech Waterproof Bags for original crash bar

### BMW R 1250 GS ADV

Waterproof storage space on your motorcycle - whether you're just off for a short ride after work, or using it as a replacement for a tank bag that is much too large, or as a luggage supplement on a round-the-world trip - is always useful! Touratech Waterproof crash bar bags are welded to make them waterproof and dustproof. You are already familiar with the robust, non-sensitive material of our Rack Packs, a double layer of which is used in the production of these crash bar bags.

With 2 x 3 litres of packing volume, these bags offer enough space for your wallet, papers, snacks or other small items.

The water-protected YKK brand zip can be easily operated even when wearing thick gloves. The extra-large zip garage effectively prevents rainwater, carried on the air stream, from penetrating.

The vehicle-specific Velcro straps make it child's play to attach the bags absolutely securely to the fairing crash bar. You can find contents quickly, thanks to the yellow interior. Your contents are additionally protected through the doubling of the material.

The design of the crash bar bag blends discreetly with the lines of your R1250GS Adventure. The reflective strip increases your passive safety through better visibility - an unbeatable plus, especially in the rain and in the dark. As a set for both sides.

Dimensions: (L x W x H) approx. 18 x 6 x 34 cm

Volume: approx. 2 x 3 litres.

037-5841



### Handlebar bag Ibarra

BMW R 1250 GS / ADV / R 1200 GS (LC) / ADV (LC)

The sturdy handlebar provides enough space to attach an extremely practical and travel-worthy bag. A wide opening water-repellent dustproof zip provides easy access to a large main compartment in which the things you need quickly - a first aid kit, spare pair of gloves, breakdown kit or also your travel documents, wallet, sunglasses and mobile phone - are well protected.

A key feature is that our bag doesn't in any way restrict the rider's movements or affect control of the bike.

045-5827



### Bag to fit under luggage rack

BMW R 1250 GS / ADV / R 1200 GS (LC) / ADV (LC)

This small yet practical bag fits perfectly into the space under the standard luggage rack, looking made-to-measure on its own or together with the side bags 045-5814. It attaches using strong and easy-to-fit belts, and its large, covered zip provides fast access to the contents.

A small bag that's big on benefits! Size: (L x W x H) approx. 26 x 20 x 5 cm

Volume: approx. 1,5 litres

Colour: black

045-5842

045-5843 Adventure



### Pillion Seat Bag AMBATO EXP

BMW R 1250 GS / ADV / R 1200 GS (LC) / ADV (LC)

The perfect solution for more luggage: AMBATO EXP! Anyone who expects more of a pillion bag than others really should take a closer look at the AMBATO EXP series! With two outer pockets, a large main compartment, the elastic drawstring on the top, the all-round zipper for when you want to increase its size and the practical carrying handle, this pillion bag can cope with any challenge! In looks, it matches the other luggage solutions in the AMBATO series, and is easily attached to the vehicle-specific base by means of two easy-opening zippers.

With a water-repellent cable hole on the inside, tasks such as charging electrical devices is not a problem. And that's just a couple of the many options offered by this pillion bag!

Size: (l x w x h) approx. 35 x 26 x 18/25 cm.

Capacity: approx. 14/22 litres.

055-1282





## Pillion Seat Bag AMBATO PURE

BMW R 1250 GS / ADV / R 1200 GS (LC) / ADV (LC)

This is the one that offers maximum benefit for minimum expense!

If you're looking for a high-quality, sturdy and rugged pillion bag that takes up the least amount of space, doesn't get in the rider's way, is easy to mount and also offers some nice, practical features, then this is the right one for you. You can be sure that we haven't cut any corners on our AMBATO PURE pillion bag: Despite its flatter design, this bag still offers an impressive amount of space. It's made of Cordura fabric, so it can take on the toughest demands and most extreme conditions, and its superb workmanship is legendary.

An outstanding value for the money that's very hard to resist!

055-1283



## Pannier AMBATO for the Luggage Rack

BMW R 1250 GS / ADV / R 1200 GS (LC) / ADV (LC)

Doesn't get in the way and is unbeatably useful!

There is plenty of room on the original luggage rack for a strong, practical bag. It is perfect for storing waterproofs, spare gloves, tools and small amounts of shopping safely and out of the weather.

Of course, this in no way impairs the passenger's comfort, and because the bag is far back on the vehicle, the rider is still able to get on with ease.

The pannier slides onto the luggage rack from the back, is secured at the front with two straps, and the special base plate ensure that it remains safely in place.

This is also a perfect ready-to-travel addition to the existing storage space!

Size: (l x w x h) approx. 24 x 29 x 17 cm.

Capacity: approx. 9 litres.

Colour: black.

045-5811

045-5836 Adventure



## Luggage Rack Side Bags

BMW R 1250 GS / ADV / R 1200 GS (LC) / ADV (LC)

The space on the left and right below the pillion grab handles is just perfect for attaching two side bags meant to hold smaller equipment items. They don't get in the way at all and offer enough storage space for items such as a first aid kit, a spare pair of gloves or your most important tools. Made of durable Cordura fabric, these bags with water-repellent zippers allow easy access to their contents and can be easily removed whenever necessary. Two small bags that fit well and unobtrusively on the bike and will prove to be very helpful!

Size: (l x w x h) approx. 37 x 10 x 9 cm.

Capacity: approx. 2 litres x 2.

Colour: black.

045-5814

045-5838 Adventure





## Inner Bag for BMW Vario Panniers and Vario Topcase

### BMW R 1250 GS / R 1200 GS (All Model Years)

Once you start to appreciate how useful these inner bags for panniers are, you'll never want to be without them!

These high quality, perfectly fitting inner bags made of tough Cordura material make packing for your trip much easier. Thanks to the inner bag with its large zipped top, at last you can be sure that everything you pack will actually fit in the pannier. During your trip, you can leave the dirty, heavy panniers and top case on the bike and conveniently carry all your luggage to your tent or room in the pannier bags, which are equipped with two handles. As the panniers on your bike are now empty, they provide you with enough space to store your riding clothing and any gear you won't be needing until the next day.

The large inner bag (045-5840) fits perfectly into the BMW Vario top case on all GS models and into the larger of the two Vario panniers (right side on models up to 2012, left side on models from 2013). Its all-round zip allows the bag to expand easily with the adjustable volume of the panniers.

Dimensions of large inner bag (l x w x h):  
approx. 38 x 22/28 x 27 cm.

Volume: approx. 22/29 litres.

Colour: black.

Dimensions of small inner bag (l x w x h):  
approx. 38 x 14/18 x 27 cm.

Volume: approx. 15/18 litres.

Colour: black.

**045-5840** large

**045-5841** small



## Additional pannier top bags for original BMW plastic panniers (1 pair)

### BMW R 1250 GS / R 1200 GS (LC)

Size: (L x W x H) approx. 46 x 24 x 13/23 cm

Volume: approx. 2 x 10/2 x 15 litres, Colour: black

**045-5810**

Not suitable for BMW R 1200 GS ADV



## Luggage Rack

### BMW R 1250 GS / R 1200 GS (LC)

A bike as big as the GS need a huge luggage rack! The Touratech luggage rack almost doubles the usable surface for your equipment! Furthermore, it blends perfectly with the design of the GS.

The solid construction consists of a stainless steel base plate that is riveted to an anodised aluminium cover. Various recesses and slots offer plenty of options for securing your cargo. The strong design provides the necessary stability even when the belts are really tight. The increased base offers space for plenty of luggage. The precisely fitting luggage rack is quickly and easily attached to existing screw points.

#### Features:

- Precisely laser cut 4 mm aluminium
- Larger surface for your luggage, with slotted holes for straps
- Original pillion handles are retained
- Extremely sturdy design

It comes with all required mounting materials, including the special spacers.

**045-5450** silver

**045-5451** black

## Hard Part for your original luggage rack

### BMW R 1250 GS / R 1200 GS (LC)

With the Hard Part you can utilise the full potential of your original BMW luggage rack. The high quality stainless steel part is simply screwed on under your plastic luggage rack. Through increased stability and distortion minimisation, the durability of your luggage rack is improved and you can fully utilise your permissible payload.

**045-5464**

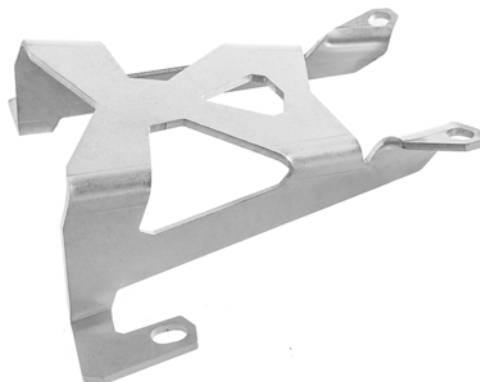



045-5460



### Pillion seat luggage rack

BMW R 1250 GS / ADV / R 1200 GS (LC)

Our pillion seat luggage rack provides numerous cut-out areas and strap loops so you can secure and transport virtually any kind of luggage. Moving the load forwards has a positive effect on the bike's ride dynamics and handling.

The unsightly „hole“ beneath the seat is closed with an unobtrusive plastic cover.

Easy and uncomplicated to use - because the original pillion seat locking mechanism is retained, this solution enables ultra-quick changes between the pillion seat and luggage rack.

045-5460 silver

045-5461 black

### Pillion seat luggage rack XL

BMW R 1250 GS ADV / R 1200 GS (LC)

045-5462 silver

045-5463 black

045-5463







## Fold-out luggage rack

### BMW R 1250 GS / ADV / R 1200 GS (LC) / ADV (LC)

The first Touratech luggage rack to adapt to your needs! Folded up, it blends neatly into contours of your GS, is no hindrance during sporty, off-road excursions, but still offers enough stowage space when you're off on a day tour. It folds out in a few seconds - no need for tools - and provides a secure place for even the largest of baggage items on your GS.

You can fit this luggage rack to your GS in just a few simple steps.

The plate fits precisely onto the existing attachment points. This sturdily built, larger luggage rack gives you a strong and stable surface providing many ways to attach your gear.

### Features

- Precisely laser cut 4 mm aluminium and 3 mm stainless steel
- Folded up, only 42 cm wide
- Folded out, up to 60 cm wide
- Larger surface for your luggage, with slotted holes for straps
- Original pillion handles are retained
- Extremely sturdy design

045-5452



## Luggage rack for Rallye seat

BMW R 1250 GS / ADV / R 1200 GS (LC) (2017-)

The Touratech luggage rack was designed specifically for the Rallye seat when riding alone. It replaces the original luggage rack. The usable surface is doubled and is lower than the BMW original. Due to this, it matches the GS Rallye design perfectly and allows better handling.

Various recesses and slots offer plenty of options for securing your cargo. The strong design provides the necessary stability even when the belts are really tight. The increased base offers space for plenty of luggage.

The precisely fitting luggage rack is quickly and easily attached to existing screw points.

### Features

- Precisely laser cut 4 mm aluminium and 3 mm stainless steel
- Larger surface for your luggage, with slotted holes for straps
- Extremely sturdy design
- Specially developed for the sporty solo driver
- Only in conjunction with the Rallye Seat

045-5453





### Luggage plate for Touratech Topcase rack and BMW Adventure luggage racks

Do you need more stability for large soft luggage on your Touratech top case carrier or BMW Adventure luggage rack? This luggage plate increases the contact surface, is super stable and allows even large pieces of luggage to be securely fastened.

- fits on every Touratech topcase carrier
- fits on all BMW Adventure luggage racks
- lightweight yet stable aluminium base plate
- 8 lashing eyes
- simple installation

037-5450





## Stainless Steel Pannier Rack

**BMW R 1250 GS / ADV / R 1200 GS (LC) / ADV (LC)**

Touratech's stainless steel pannier rack for the GS is a sturdy rack designed to take Touratech ZEGA Pro cases. This is the perfect pannier system for extended touring.

Made of 18 mm stainless steel tubing, this non-rusting system matches the appearance of the bike's frame and guarantees extra high stability even off the beaten track. Fitted as closely as possible to the vehicle frame using existing attachment points. Just a few screws is all it takes for the very strong construction to be securely attached (or removed). The angle brackets remain unobtrusive on the motorbike. The fitted width of the pannier rack is 51 cm.

- Made of 18 mm stainless steel tube
- Also suitable for tough off-road use
- No restrictions to pillion
- Blends elegantly with the overall look of the BMW R 1200 GS | R 1250 GS
- Easy to fit and remove

**038-5560** black

**038-5555** silver



045-5455

## ZEGA Topcase Rack

The special mounting for our ZEGA top cases.

Made entirely of stainless steel and extremely robust, the top case carrier is the perfect mount for ZEGA Pro and Evo top cases. The design and function of the carrier was developed specifically for the requirements of the BMW Boxer GS. It can be mounted on both the GS and GS Adventure.

In addition, the passenger hand grips are part of the carrier. And, of course, the top case can be secured without restricting the passenger. The carrier can be used alone or in conjunction with the case system.

**BMW R 1250 GS / R 1200 GS (LC)**

**045-5455**

**045-5456** black



045-5457

**BMW R 1250 GS / ADV / R 1200 GS (LC) / ADV (LC)**

**045-5457**

**045-5458** black

## ZEGA Evo / ZEGA Pro Topcase

The ZEGA Pro and ZEGA Evo Topcase offers all of the same advantages as are found with our tried and tested ZEGA Pro and ZEGA Evo panniers! Absolutely waterproof Topcase made from rugged, polished aluminium with protective corners! On the lid are four top loops for attachment the luggage.

Dimensions:

25 Litre Topcase (L x W x H):	315 x 400 x 180 mm
38 Litre Topcase (L x W x H):	315 x 400 x 300 mm

(helmet fits in!)

ZEGA Pro



Integral lock 050-0870 & 050-0871 ZEGA Pro | 050-6001 ZEGA Evo optional.

### ZEGA Pro Topcase

050-0680 38 Litres

### ZEGA Pro AND-S Topcase

050-0682 38 Litres

### ZEGA Pro AND-Black Topcase

050-0683 38 Litres

### ZEGA Evo AND-S Topcase

050-6066 25 Litres

050-6076 38 Litres

### ZEGA Evo AND-Black Topcase

050-6067 25 Litres

050-6077 38 Litres



ZEGA Evo





## Toolbox for original case carrier

**BMW R 1250 GS / R 1250 GS Adventure  
BMW R 1200 GS / R 1200 GS Adventure**

The Touratech tool box is the ideal solution for the safe storage of small items on your GS. The optimal utilisation of space on the vehicle allows tools, first-aid kit, breakdown kit and many other useful items to remain on the motorcycle permanently and without interfering. They are always readily accessible, even when the cases are not mounted.

The approx. 4.2 litre large storage space is protected against spray water and a large opening makes loading and unloading easy, even when the cases are mounted. The lid can be removed completely for easier loading, a safety mechanism prevents loss.

The toolbox was developed specifically for the original BMW case carriers and matches the GS in materials and design. The perfect combination of stainless steel and plastic provides optimal stability and a look that is difficult to beat. Even if the cases are not mounted, it is an absolute eye-catcher!

Using special clamps, the box can be mounted to the case carrier easily and very quickly. A protection cap on the lock against spray water provides permanent ease of use.

Quality „Made in Germany“

- lockable and resistant
- important small items are always readily accessible
- optimal utilisation of space on the vehicle
- protected against spray water

Dimensions: 33 x 9.5 x 19.5 cm

Volume: 4.2 liters

Material: plastic, stainless steel

**045-5610**

**Internal bag  
for toolbox**

**p. 486**



**Note:**

**Toolbox for original stainless steel  
pannier rack BMW**

- BMW R 1200 GS (2004 – 2012)
- BMW R 1200 GS ADV (2006 – 2012)
- BMW R 1250 GS / R 1200 GS (LC)
- BMW R 1250 GS ADV / R 1200 GS ADV (LC)



## Luggage space expansion ZEGA Mundo, ZEGA Pro + BMW Adventure Case

We have designed a series with a sensible luggage space expansion for your new ZEGA PRO. This adapter solution can be fitted anywhere on the outside of the case. At the heart of the system is the base plate. This „docking station“ is appropriate and necessary for all of the adapters offered on this page.

The system offers the advantage of enabling any adapter to be used on a single base plate. So once the base plate has been fitted, you can use any of the adapter plates shown here to suit your particular purpose - it's a flexible, well-designed system that is ideal for all kinds of trips'n'tours.

The base plate and adapter are extremely sturdy, and mean that additional fuel cans, bottles etc. can be safely and securely attached without damaging or dirtying your other luggage.

Made of stainless steel with all the necessary attachments and detailed fitting instructions. Suitable for all ZEGA Pro cases and the 35 and 41l ZEGA cases.

### Base plate

050-0830

ZEGA Pro/ZEGA Mundo - Adapter plate with straps protection with Ortlieb first aid kit by Touratech Waterproof

050-0914

Simple and fast - changed by just one click!

Adapter plate with Ortlieb additional bag - including Touratech waterproof additional bags

050-0840 size S

050-0842 size L



More Cases Accessories  
see from page 480!

050-0830





# VOLUME BOOSTER



## Pannier extension VOLUME BOOSTER for original BMW aluminium pannier

BMW R 1250 GS / R 1250 GS Adventure /  
BMW R 1200 GS (LC) / R 1200 GS Adventure (LC)

Get the most out of your pannier and create maximum space! The VOLUME BOOSTER pannier extension increases the volume of your original BMW aluminium pannier by 12 litres!

Simply place the VOLUME BOOSTER between the pannier and the lid to increase the height of your pannier by 11 cm. The ingenious mechanism engages in the lockable latch of your pannier and makes any other locking system superfluous. In a matter of seconds, you can hook in the new safety cable and open, load and close your pannier as usual. The pannier extension is made of the same high-quality materials as your BMW pannier. Thanks to the precise fit and the seal in the plastic frame, your pannier remains waterproof and fits perfectly.





**The advantages at a glance:**

- 12 litres additional luggage volume
- Securely lockable using existing latches - no additional latches required
- Easy to open and completely removable
- Made of the same high-quality, visually and technically identical materials as your BMW pannier
- Waterproof due to special seal in the plastic frame
- Robust construction made in Germany

Original BMW OEM number:

pannier right: 8 562 410 (ECE) / 8 414 630 (USA)

pannier left: 8 562 409 (ECE) / 8 414 629 (USA)

Size: (L x W x H) approx. 27 x 44 x 11 cm

Volume: approx. 12 litres

We recommend using only one VOLUME BOOSTER per pannier! Please observe the permissible maximum payload of your vehicle! The BMW pannier is not included!

**050-1010 aluminium**

**050-1011 aluminium (set of 2)**

**050-1012 black**

**050-1013 black (set of 2)**

**Touratech Booster Bag**

The Touratech pannier bag especially for your new VOLUME BOOSTER!

The Booster bags also fit in our ZEGA aluminium panniers perfectly. Discover the combination possibilities!

With these versatile bags used for arranging your luggage and keeping it together you will be better organised immediately. The material is super robust and water repellent! It has a full length zip and a carrying handle of course.

Size: 42 x 25 x 9 cm

**050-0837**





## Protective pannier lid covering decal for BMW aluminium panniers

**BMW R 1250 GS / ADV / R 1200 GS (LC) / ADV (LC) / F 850 GS ADV**

The Touratech protective pannier lid covering is much more than an ordinary adhesive foil for your pannier lid! Why do you need it? Because the stresses and strains of everyday travel life have increased.

Due to its special „raindrop“ surface, this precisely cut covering provides optimum grip as well as slip protection.

This means that your luggage is held on the lid even more securely, reducing strain on the lashings.

The protective pannier covering is well able to meet the toughest demands - when you use the pannier as a motorcycle assembly stand, for example.

The two millimetre thick rubber padding made of polyurethane is not only extremely resilient, it also allows scratches and even deep grooves in the pannier lid to simply disappear. Despite this, it is impossible for the protective film to become saturated with water.

Tip: The polyurethane anti-slip coating reduces the risk of getting a cold butt if you use the pannier as a seat!

The self-adhesive anti-slip mat can be applied to the lid of the pannier quickly and easily.

- High slip resistance
- High wear resistance
- Impact resistant
- Durable
- Precisely cut to size (2 mm distance to each corner and edge of the pannier lid)

Thickness: 2 mm

Dimensions: 377 x 212 mm

Colour: black

Materials: Polyurethane

### Quality:

Dekra certified quality to VDI 2700, sheet 14

Slip resistance tested to DIN 51130

Friction value, also in wet conditions,  $\mu_D > 0.60$

Coefficient of friction  $\mu = > 0.90$

**045-5599**



TOURATECH  
**NEW  
PART**



ZEGA MUNDO

ZEGA PRO



R 1250 GS / ADV | R 1200 GS / ADV (LC)

### ZEGA Mundo / Pro Aluminium Pannier System

BMW R 1250 GS / ADV / R 1200 GS (LC) / ADV (LC)

The aluminium pannier system again has a very robust construction. We have tried to bring the pannier racks and the panniers as close as possible to the motorcycle. Numerous tests have already been performed in order to ensure that the entire development satisfies the required demands. The rack is made of 18 mm steel tubing and is attached to existing mounting points using special fixing clips and reinforcing pieces.

- Pillion comfort not restricted in any way.
- Enhances the enduro and touring appearance of the R 1200 GS | R 1250 GS.
- All pannier systems are preassembled.

AND-S / AND-Black: anodised aluminium panniers.

For further information on ZEGA Pro and accessories please have a look at pages 436 et seqq.



AND-S

AND-Black



**ZEGA MUNDO**

**ZEGA PRO**

**ZEGA EVO**



More information  
about ZEGA cases  
from page

**>436**



Pannier system with:	Stainless steel rack	Stainless steel rack black
ZEGA Mundo 31/38 litres	<b>045-6130</b>	<b>045-6180</b>
ZEGA Pro 31/38 litres	<b>045-5730</b>	<b>045-5780</b>
ZEGA Pro AND-S 31/38 litres	<b>045-5731</b>	<b>045-5781</b>
ZEGA Pro AND-Black 31/38 litres	<b>045-5732</b>	<b>045-5782</b>

Pannier system with:	Stainless steel rack	Stainless steel rack black
ZEGA Mundo 38/45 litres	<b>045-6135</b>	<b>045-6185</b>
ZEGA Pro 38/45 litres	<b>045-5735</b>	<b>045-5785</b>
ZEGA Pro AND-S 38/45 litres	<b>045-5736</b>	<b>045-5786</b>
ZEGA Pro AND-Black 38/45 litres	<b>045-5737</b>	<b>045-5787</b>



# ZEGA EVO



## Viva la Evolution!

Continuous EVOLUTION - under this motto we have further developed our ZEGA pannier systems and so the name of our latest aluminium pannier was clear from the start. The ZEGA Evo combines the robustness proven ten thousand times over with extra convenient handling - not least thanks to a completely new fastening system.

For further information on ZEGA EVO and accessories please have a look at pages 461 et seqq.





- 1 Newly designed plastic corners - protect driver and pannier in the event of an accident
- 2 Proven fixing pins - for ZEGA Evo accessory holder
- 3 Proven handle - for comfortable carrying
- 4 Newly developed fastening system - for easy mounting and secure hold on the pannier rack
- 5 Newly developed lockable one-hand locking system - for convenient and secure attachment to the pannier rack
- 6 Newly developed lockable lid catch- for convenient opening and closing from both sides, thanks to practical hinge function
- 7 Proven silicone seal - for a pannier that's dry on the inside, even in the pouring rain
- 8 Proven attachment eyes - for secure fastening of pannier lid bags and other soft luggage
- 9 Standard hooks on the inside of the lid - for attaching accessories (bags, nets)



**BMW R 1250 GS / ADV  
R 1200 GS (LC) / ADV (LC)**

**stainless steel rack**

**stainless steel rack  
(black)**

**width**

**AND-S 31 / 38 L**

**045-6831**

**045-6881**

**96 cm**

**AND-Black 31 / 38 L**

**045-6832**

**045-6882**

**96 cm**

**AND-S 38 / 45 L**

**045-6836**

**045-6886**

**104 cm**

**AND-Black 38 / 45 L**

**045-6837**

**045-6887**

**104 cm**



### **Exhaust extension for ZEGA Evo X special system**

**BMW R1250GS/ADV / R1200GS (LC) / ADV (LC)**

The heat dissipates optimally. The exhaust extension effectively prevents heat build-up in your ZEGA case. The perfect complement to your new ZEGA Evo X special system!

Suitable for original silencer only!

**045-5597**



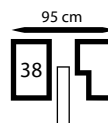
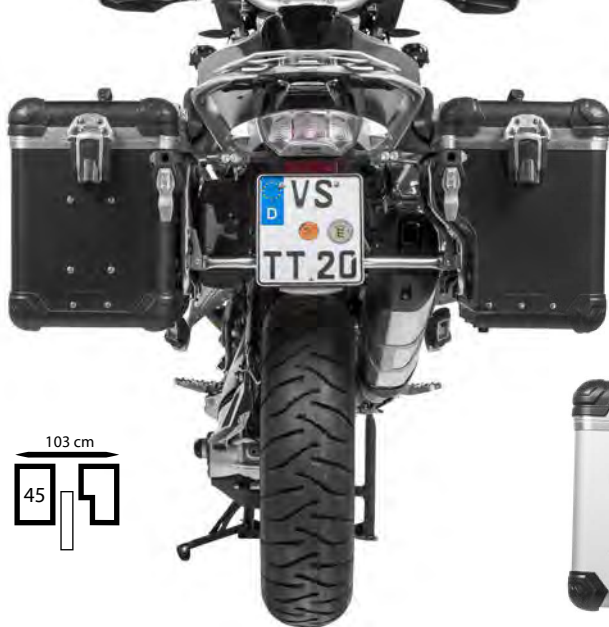

### ZEGA Evo X special systems

#### BMW R 1250 GS / ADV / R 1200 GS (LC) / ADV (LC)

The ZEGA Evo, like all Touratech panniers before it, was not developed as an isolated product but was intended from the outset to be part of a luggage system. The outstanding practical benefits are the result of the unique combination of an elegant and indestructible pannier, an ingenious fastening mechanism and a terrain-immune rack made of 18 mm thick stainless steel tubes.

A typical feature of the special system is the recess on the right-hand pannier that allows it to nestle snugly against the exhaust. The panniers are positioned closer to the bike's centreline, the overall width is reduced, and the system as a whole appears more balanced thanks to the symmetrical pannier lids. Made from stainless steel, the sturdy pannier racks are scratch and rust resistant.

Special System with:	stainless steel rack	stainless steel rack black
ZEGA Evo AND-S 38/38 litres	<b>045-6816</b>	<b>045-6866</b>
ZEGA Evo AND-Black 38/38 litres	<b>045-6817</b>	<b>045-6867</b>

Special System with:	stainless steel rack	stainless steel rack black
ZEGA Evo AND-S 45/45 litres	<b>045-6826</b>	<b>045-6876</b>
ZEGA Evo AND-Black 45/45 litres	<b>045-6827</b>	<b>045-6877</b>



## Toolbox for ZEGA Evo pannier systems

BMW R 1250 GS / ADV / R 1200 GS (LC) / ADV (LC)

The Touratech tool box is the ideal solution for the safe storage of small items on your GS. The optimal utilisation of space on the vehicle allows tools, first-aid kit, breakdown kit and many other useful items to remain on the motorcycle permanently and without interfering. They are always readily accessible, even when the cases are not mounted.

The approx. 4.2 litre large storage space is protected against spray water and a large opening makes loading and unloading easy, even when the cases are mounted. The lid can be removed completely for easier loading, a safety mechanism prevents loss.

The toolbox matches the GS in materials and design. The perfect combination of stainless steel and plastic provides optimal stability and a look that is difficult to beat. Even if the cases are not mounted, it is an absolute eye-catcher!

Info: if you require a certain key number, please use item 01-050-0870-0 and enter the quantity required.

Using special clamps, the box can be mounted to the case carrier easily and very quickly. A protection cap on the lock against spray water provides permanent ease of use.

Quality „Made in Germany“



- especially for ZEGA Pro2 pannier systems and special systems
- lockable and resistant
- important small items are always readily accessible
- optimal utilisation of space on the vehicle
- protected against spray water

Dimensions: 33 x 9.5 x 19.5 cm

Volume: 4.2 liters

Material: plastic, stainless steel

The mudguard should be removed for off-road use.

Not with Touratech Suspension with external compensating reservoir.

**045-5614**

## Mounting kit for toolbox without pannier rack

BMW R 1250 GS / ADV /  
R 1200 GS (LC) / ADV (LC)

With this mounting kit, you can mount your Touratech tool box (01-045-5610-0) on your GS (LC) without a pannier rack.

045-5613



## Wall bracket for Touratech ZEGA panniers and topcases p. 487

### Wall bracket for original BMW Adventure aluminium panniers

They are space-saving and versatile, the Touratech wall holders for BMW Adventure cases. Simply mount your panniers on the wall behind your motorbike. The panniers are no longer in the way when they are not needed. This way they won't get unnecessary scratches or dents. By using the original stainless steel supports, your BMW Adventure cases fit ideally on the Touratech wall mount. Really tight. Of course, the locking function of the existing case lock can also be used. Because a good wall bracket also helps against theft! To ensure extra ease of use, the case, when mounted, is at an optimum distance from the wall. Due to the clever construction similar to a pannier rack, the panniers can be mounted on the holders even when fully loaded. This makes the Touratech wall brackets 100% usable on motorhomes, trailers or pickup trucks, in contrast to the usual simple bent sheet metal constructions.

**Compatible with BMW aluminium cases for:**

- BMW R 1250 GS
- BMW R 1250 GS Adventure
- BMW R 1200 GS (LC)
- BMW R 1200 GS Adventure (LC)
- BMW F850GS Adventure

Original BMW OEM number:

Case right: 2 455 446 (ECE) / 2 459 679 (USA)

Case left: 2 455 445 (ECE) / 2 459 676 (USA)

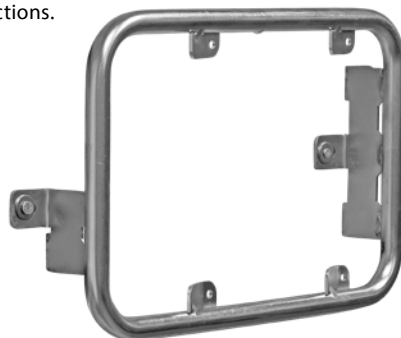
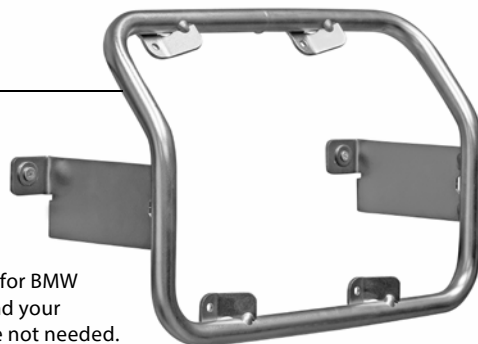

045-6150 2 x wall bracket for BMW Adventure panniers

045-6170 wall bracket for BMW Adventure aluminium topcase



# NEXT GENERATION



## CONNECT

The latest version of the Touratech Connect smartphone app offers a veritable plethora of new functions. Its use as a real-time display is complemented by extensive analysis, export and sharing features. In addition, the application is now available for numerous other motorbike models.

The basic idea behind the Touratech Connect app is to turn your smartphone into a multifunctional real-time display for your motorcycle cockpit. This application, which is available for iOS and Android operating systems, gathers the data directly from the machine's CAN bus via a dongle and enables the visualisation of an incredible wealth of information. The display can be freely configured so that users are shown precisely the values they need.

### Fine tuning and new features

In the latest version of Touratech Connect, existing functions have, on the one hand, been further improved. It is now possible to not only display the maximum lean angles comprehensively, but to also differentiate between left-hand and right-hand curves. Certainly a useful feature for fine-tuning your own riding technique.



[WWW.TOURATECH-CONNECT.COM](http://WWW.TOURATECH-CONNECT.COM)

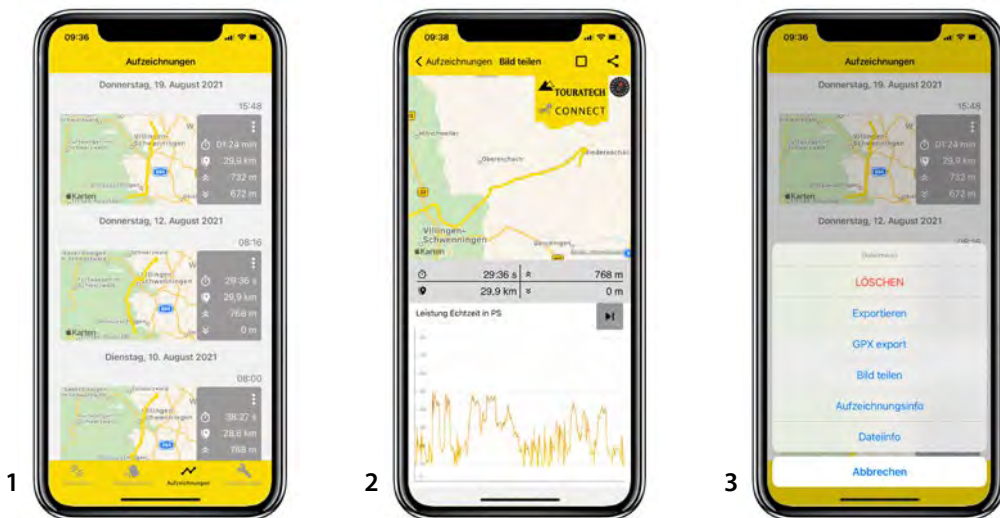

- 1 | The track of a travelled route can be visualised on a map.
- 2 | Along the track, random points can be selected for which vehicle data is displayed.
- 3 | Data can be shared, exported or deleted.

On the other hand, the app has received a lot of additional functions. Particularly interesting is the route tracking, which goes far beyond recording the distance travelled. Tracking starts with every activation of the app. The high-resolution track can be displayed on a map and - here comes the highlight - the recorded parameters can be visualised for each point. By linking vehicle and geodata in this way, the performance of bike and rider can be precisely assigned to specific riding situations on the track.

Points along the route can also be accessed using a slider that corresponds to the timeline of the journey. The GPS module of the smartphone is used for tracking, which also records the altitude. The function can be deactivated at any time.

### Sharing with the Community

Another new feature is the ability to share data. The user selects a specific data type, for example the switching profile on a specified track, and can share the corresponding graph along with a map representation of the associated track. This is done via either email, Facebook or Instagram. The format of the screenshot can be adjusted depending on

the selected social network it is to be posted in.

### Even more practical relevance

In response to a frequently expressed request from the beta testers, the Touratech programmers have created the „Remember PIN“ function so that the user no longer has to reenter their code after every app start.

Another practical new feature is the ability to export the app data. This means that all determined values are also immediately available on a new smartphone. Numerous other detailed improvements in data collection and presentation, such as the possibility of labelling data fields, round off this huge range of functions.

Last but not least, Touratech Connect is now available for even more motorbike models. This means that the app now works with all BMW boxer models from model year 2015 onwards. Existing customers will simply receive the new functions via an update.

092-0010



## Tankpad "Touratech"

The Touratech Tankpad is not only an absolute eye-catcher, but also effectively protects the surface of the tank against dirt and scratches. The 3D design also has a lot to offer in terms of functionality. The PVC film has been reinforced in a special process to make the design and also the protection more durable. The sticker is resistant to petrol. Even an extensive motorbike wash will not harm it.

- 2 mm thick
- approx. 20 cm x 10 cm
- good UV resistance
- weatherproof
- guaranteed no bubbles
- fits on almost every tank

Protect your tank now from scratches caused by belt buckles, dirt under the tank bag, etc. with the Touratech Tankpad!

600-0080 2 parts

600-0081



## Airfilters

On many of our trips in dusty and dry countries and on many sporting events and rallies we had the problem that fine dust kept on getting through the air filter and into the intake system. Sometimes with serious consequences for the engine. We have tried and tested a large number of air filters over the last few years. We found the solution to our dust problem in Australia. Unifilter Australia gave us an air filter to test that fully met our expectations. The Touratech Research & Development team used the Unifilter in all the races and since then have found no dust residue in the air filter box.

Another advantage of the filter, made of high-tech foam, is the long service life. The filter is not thrown away when it's dirty but rinsed out, lubricated again and used time and time again. So you don't just take care of your engine but also your wallet.

## Unifilter - High performance

BMW R 1250 GS / ADV / R 1200 GS (LC) / ADV (LC)

Scope of delivery: Main filter, filter supplies pre-oiled ready for use. Unifilter high performance, Made in Australia

045-0871

## Snorkel pre-cleaners

BMW R 1250 GS / ADV / R 1200 GS (LC) / ADV (LC)

Scope of delivery: 2 x Snorkel pre-cleaners, Unifilter high performance, Made in Australia

045-0872



## HEX ezCAN Generation II for BMW motorcycles

The ezCAN for BMW is an affordable and innovative solution which enables you to easily retrofit your BMW motorbike with electronic accessory parts and even configure them via a PC software.

### Possible retrofits:

- Additional lights
- Audible signalling device
- Rear and brake lights
- GPS device
- Seat heating
- Charging device
- Heated motorbike handlebar

Only a few steps are required for installation, the different accessory parts will be connected directly to the respective ezCAN output modules. Due to the barely noticeable Plug & Play integration into the motorbike, changing anything in the already installed electronics is not necessary. With this you can customise your motorbike to meet your own standards and to provide more security while driving.



- One device for all accessory parts
- 2 x 10A outputs
- 100% reversible
- Waterproof and dustproof
- Manufacturer guarantee is not lost
- Simple configuration via PC software
- Plug & Play integration
- Colour-coded modules
- Improved personal safety
- Increased driving enjoyment
- Affordable and user-friendly
- E labelling

### Models supported:

- R 1200 GS LC - K50 (2013–2018)
- R 1200 GS LC Adventure - K51 (2014–2018)
- R 1200 RT LC - K52 (2014–2018)
- R 1200 RS LC - K54
- R 1200 R LC - K53 (2015–2018)
- R 1250 GS - K50 (2019–)
- R 1250 GS Adventure - K51 (2019–)
- R 1250 RT - K52 (2019–)

030-0107





## Diagnostic tool Duonix Bikescan-100

for BMW motorbikes

The Bikescan-100 is small and powerful and therefore ideal for professional control unit diagnostics on BMW motorbikes. This system covers the entire motorbike electronics and makes troubleshooting much easier for the user. The many special functions and settings can be carried out directly on the device without connecting the system to a computer or laptop. Ideal for travelling.

030-0105

030-0104 Bikescan -100 Pro OBD 2



## Touratech BMW motorcycle toolset, 70 PCS

BMW R 1250 GS / ADV / R 1200 GS (LC) / ADV (LC)

The professional tools for your BMW motorcycle. A lot of great ideas and many impressive patent tools has been put into this one to ensure that we are always innovating for the better. The dream set for your road trips and any repair works you encounter.

All the tools are made with the best quality materials, S2 Bits with Black Phosphate finishing anti-rust. Cr-V Satin Chrome Plated sockets and spanners.

MIT (Metric/Inch/Torx): The MIT print work on various type of nuts: Square, 6 or 12 points, Star, Spline and damaged.

070-2211



## CruzTOOLS RoadTech B2 Tool Kit for BMW Motorcycles (2019-)

- 34mm rear axle wrench and 10x12x19x22mm hex adapter for BMW axles & drain plugs
- Combination wrenches (8mm, 10mm, 12mm, 13mm), and an 8" adjustable wrench
- Mini ratchet with 2" extension and sockets (8mm, 10mm, 12mm, 13mm)
- 6 Torx keys, 5 hex keys, 6-in-1 screwdriver, locking pliers
- Duct tape, thread-lock, cable ties, mechanics wire, and tire pressure gauge
- Organized in a durable roll-up pouch
- Rolled Up Dimensions: 10 x 4.2 x 3.25 in
- Entire Kit Weight: 3.85 lbs

070-2103



## OBD-II adapter for diagnostic tool Duonix Bikescan-100

for BMW motorbikes

For using the Duonix Bikescan-100 with the OBD-II interface on BMW motorcycles.

030-0106



## Dual USB Plug-n-Play socket

for BMW motorbikes

Let's be honest: Do you really use the DIN socket on your BMW? Simply replace it with the much more useful double USB socket! Charge your smartphone, camera, GPS, etc. without adapter while driving!

- Input voltage: 10 to 40 V
- Output voltage (USB ports): 5 V +/- 5%
- Output overvoltage, overheating and short-circuit protection
- Fully CanBus compatible
- Total 3.3 Amp output, with current limiters per port (master port 1: 2.3 A / Aux port 2: 1.0 A)
- Intelligent device recognition: detects if Apple (meets MFi standard) or Android (BC1.2).
- Weatherproof: independent port rubber covers
- Plug compatible with BMW motorcycle DIN socket installation

030-0084



## Power cable BMW CAN BUS

for BMW motorbikes

For connection of e.g. GPS devices to the original BMW CAN bus plug.

This adapter cable is connected to the open cable ends (+/-) of the device manufacturer's optional power cable.

065-0293



## DIN socket relocation kit

BMW R 1250 GS | R 1250 GS Adventure | R 1200 GS (2013-) | R 1200 GS Adventure (2014-)

This set is used to install the DIN socket so that it can continue to be used after the double USB socket 01-030-0084-0 has been installed. With it, it will be possible for you to continue to use your BMW battery charger and even an air compressor for the tyres.

Your package contains the following items:

- Mounting brackets
- Cable harness for batter connection with fuse

030-0086

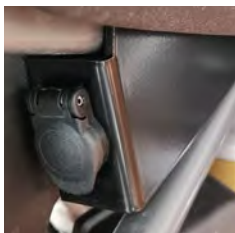



NEW IDEAS FOR MOTORBIKES

**TOURATECH**



- 1 Handlebar | Cockpit | Windscreens | Lighting from p. 132
- 2 Seats page from p. 142
- 3 Suspension from p. 145
- 4 Engine guard | Cylinder protection | Fairing from p. 150
- 5 Foot pegs from p. 156
- 6 Tank bags from p. 160
- 7 Tail rack bags from p. 163
- 8 Pannier systems from p. 165



# BMW

## R 1200 GS

AIR COOLED (-2012)

## R 1200 GS ADV

AIR COOLED (-2013)







## Windscreen spoiler Evo, with ABE

### BMW R 1200 GS / ADV

Whether you need it for your original windscreen or as accessory to your new Touratech windscreen - with Touratech's windscreen spoiler Evo, you absolutely gain extra comfort on each terrain.

Evo offers the right balance between protection and ventilation - whether you drive on motorways, roads or off-road. Height, inclination and distance to the windscreen can easily be adjusted - you do not need any tools.

If you are going fast and the weather is rainy,

fasten the spoiler at its highest level to benefit from an effective wind and weather protection. It is a noticeable relief for your head and upper body, and wind noises in your helmet are significantly reduced.

If you set the lowest level, the windscreen spoiler almost disappears. This guarantees maximum ventilation when riding off-road.

**040-1380** transparent

**040-1381** tinted





### Headlight Protector with Quick release Fastener \*OFFROAD USE ONLY\*

BMW R 1200 GS / ADV

The quick release fastener lets you fit and remove the headlamp protectors in seconds.

The headlight protector has been developed for off-road use and is not permitted in the scope of German StVO. Please check your national regulations!

Stainless steel headlight protector with quick release fastener

044-5095

### Anti-Glare Shield

BMW R 1200 GS / ADV

The new anti-glare shield really enhances your R 1200 GS /Adventure look. It reduces scattered light, especially when fitted together with headlight covers and thus protects you from being dazzled by the lights, too.

044-0322

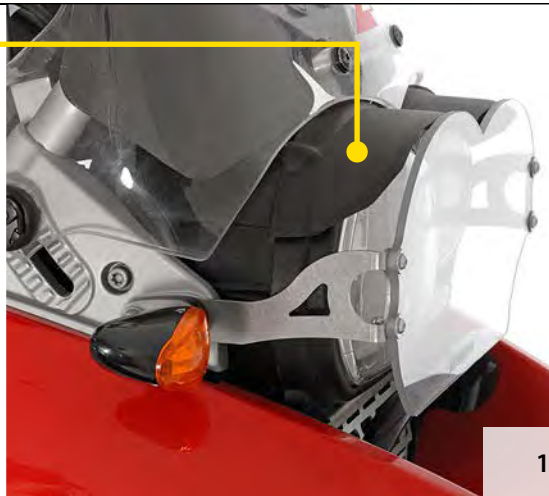

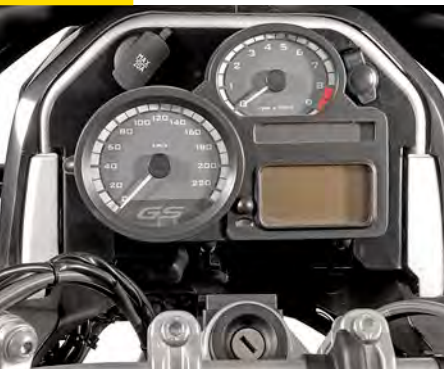

## Cockpit Cover 2 (Tachometer Unit) with small and big socket

BMW R 1200 GS / ADV

The cockpit cover 2 covers the R 1200 GS's tachometer unit. In addition, it features an integral, fused on-board socket. For example, mobile phones or GPS units can thus be plugged into the cockpit directly without having to run annoying cables around the motorbike. Because of the fused direct connection, these units can be charged even when ignition is off. Normally this causes problems with the R 1200 GS. This black cover is made from powder-coated aluminium and includes stainless steel mounts. It fits perfectly.

044-0562 (2008-)

## GPS Adapter

BMW R 1200 GS

In order to position a GPS unit on the R 1200 GS so that you can see it properly we have developed a sturdy stainless steel bracket adapter for nearly all Touratech GPS handlebar brackets. You can thus position your GPS unit properly above the instruments of your R 1200 GS. This bracket adapter is incorporated into the front part of the R 1200 GS. The inclination of the bracket can be set in different positions and the bracket is wide enough for you to be able to position a GPS unit, for example, wherever you want. When using many GPS units with brackets, because of the size of the unit, you can't avoid concealing a small part of the instruments depending on the position of the windscreen. But as you can select the precise position yourself, this can be set as you wish.

040-0667



## GPS Adapter

BMW R 1200 GS / ADV

Durable adapter for Touratech handlebar brackets. This adapter enables you to fit your GPS unit in such a way that you can see it clearly. It is fitted to the top windscreen support on the Adventure. Ideal for offroad use. Not for MVG-bracket! (Delivery does not include the GPS bracket)

044-0770



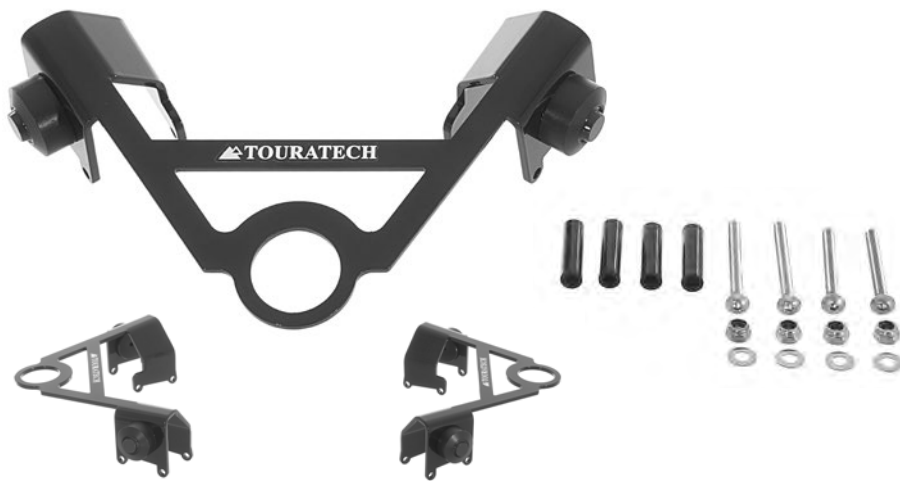

## Hard Part LA Steering Stop

### BMW R 1200 GS / ADV

Even during minor accidents or if the motorcycle falls over, the front wheel may, for example, come into contact with the road surface so unfavourably that the standard steering stop on the yokes and calliper support is bent or shears off. Replacement of the yokes and calliper support is expensive and annoying, and additional parts may also be

destroyed. The LA R 1200 GS hard part is made of laser-cut aluminium and tough plastic parts which absorb the impact. A small section is also muffled by a resilient rubber pad. The steering stop is barely restricted by the LA R 1200 GS hard part. The aluminium part is coated with plastic powder. The delivery schedule includes all necessary mounting materials such as spacers, nuts and bolts. Weight: approx. 114 g; Dimensions: approx. 195 mm x 135 mm x 50 mm

044-0403

## Handlebar Crossbar

### BMW R 1200 GS / ADV

With our handlebar crossbar fitted to your R 1200 GS, you can now also place a roadbook holder, motorcycle computer or navigation systems in your direct field of vision. A very useful part made from aluminium.

040-0603 (-2007)

Doesn't fit with BMW R 1200 GS with I-ABS 2, e.g. R 1200 GS ADV (2007-)





## GS Handlebar Risers

### BMW R 1200 GS

BMW R 1200 GS 30 mm handlebar riser. With this handlebar riser you can twist your handlebars round and increase the overall height of the handlebars somewhat. Caution: Unfortunately you can't just raise it because the windscreen is in the way.

- CNC machined aluminium
- 30 mm higher handlebars
- Screws included



**040-0274** (-2007) black

**044-1067** (2008-) silver

## Throttle control, mechanical cruise control

### BMW R1200 GS / ADV

The original by the South African inventor!

The throttle control replaces the original handlebar end weights. The anti-slip knurled screw secures the accelerator in position. This significantly reduces the strain on the right hand during long journeys. Thanks to the continuous adjustment, the accelerator can also be fixed to decelerate very gently - leaving you enough time to take your hand off the handlebar for a moment without immediately losing throttle. Despite that, the motorbike decelerates in a gentle and controlled way.

This item is illegal in road traffic in Germany and could be dangerous if used incorrectly. We are unable to accept any responsibility for it. Used at the owner's/rider's own risk.

**044-2300** (2008-)



Photo: Michel Dougoud





### Rear-view mirror Adventure folding M10x1.5

Two different basic positions and an adjustment range of 180 degrees with eleven different locking positions cover all eventualities for adjusting the mirror. The rear-view mirror can be folded during off-road travel and during transport to avoid any damage.

- can be set to eleven predefined positions
- can be used left or right
- with ECE certificate
- patented design

Scope of delivery 1 mirror with instructions for installation and adjustment. Length 26 cm.

040-0770

### Mirror extension M10 x 1,5

The mirror extension puts the mirror in a much better position. This improves the rider's field of vision. This discreet component increases safety and is almost unnoticeable.

040-0648





## Spoiler for Original

### BMW Hand Protectors

Optimal hand protection improves the original protectors. Very useful and pleasant in rain, snow, hail and cold. The spoilers are made of resistant and light synthetic. Easy to fix!

Colour: black. Very useful accessories for the GS-biker.

040-1701 (-2007)



Photo: Jon Beck



### Folding Mirror, Length Adjustable

Universal folding mirror, length and angle continuously adjustable, to suit most motorbikes.

- Suitable for use on left or right
- Carries the E-test mark.

040-0760

Mounting adapter BMW R1200GS

040-0761



### Safety rear-view mirror set

Thanks to the aspherical part, the visible area is increased - making the "dead angle" a thing of the past.

- Carries the E-test mark.

040-0780

## Diagnostic tool Duonix Bikescan-100

for BMW motorbikes

The Bikescan-100 is small and powerful and therefore ideal for professional control unit diagnostics on BMW motorbikes. This system covers the entire motorbike electronics and makes troubleshooting much easier for the user. The many special functions and settings can be carried out directly on the device without connecting the system to a computer or laptop. Ideal for travelling.

030-0105



## OBD-II adapter for diagnostic tool Duonix Bikescan-100

for BMW motorbikes

For using the Duonix Bikescan-100 with the OBD-II interface on BMW motorcycles.

030-0106





## Comfortable seat FRESH TOUCH

Comfort can also look good! Stylish seat modules for the R 1200 GS/Adventure. These seats are made from high-quality materials and are specially adapted to the ergonomic requirements of long-distance trips. Thus, our seat largely minimises marks on your thighs caused by wrong padding or seams in the wrong places. The very strong padding effectively prevents a sore bottom. You will no longer feel “whacked” even after many miles. In addition, the seat is shaped in such a way that you can enjoy an almost perfect, comfortable riding position. Because of the high-quality, tightly fitted synthetic leather cover, the seats’ contours do not show and water cannot collect on the seats when it is raining. The pillion passenger seat has another important benefit as it helps prevent your pillion passengers from sliding forwards when braking. This means even more riding comfort for them. With these seat modules you will no longer have to be afraid of very long-distance journeys when riding on your own or with somebody else. You can order both the pillion passenger seat and the driver seat separately. Both seats can also be easily fitted together with the series models.

<b>044-5949</b>	extra low	48 cm
<b>044-5950</b>	low	50/52 cm
<b>044-5951</b>	standard	51/53 cm
<b>044-5952</b>	high	54/56 cm
<b>044-5957</b>	pillion passenger	

## FRESH TOUCH

The high quality, multi-layer seat cover is equipped with a durable Fresh Touch surface coating. It reduces the surface temperature by significantly reflecting infrared light radiation and providing a cooler feeling when mounting a motorcycle parked in the sun. An additional, exclusive gain in comfort for your riding pleasure!





### Comfort Seat DriRide \*Breathable\*

The ultimate seat combination for the R 1200 GS and it can also be used in modular form.

The newly developed DriRide seat sets the standards in seating comfort. With this comfortable and actively-breathing seat, you will experience pleasant and relaxing riding, even on long trips - and you can forget about high temperatures and humidity! The seats are made from the highest-grade materials and especially customised to ergonomic requirements over long distances. Air circulation in the seat area remains at an absolute optimum thanks to the superlative, actively-breathing seat design - even on long and hot journeys. Sticky and crumpled underclothing is now effectively a thing of the past. Besides the use of actively-breathing materials, which considerably improve seat comfort in the long-term, it also provides effective protection against uncomfortable pressure points on your upper thighs. During conception and design, great care was taken to

achieve perfect cushioning - and to ensure that the seams cannot be felt. The high-strength cushioning protects your posterior - really effectively. The seat cannot be dented - even after long and hard use. The contours are designed to ensure sheer comfort for you, the user. The pillion seat is designed in such a way that it is almost impossible for your passenger to slide forward when you brake - and this really improves the degree of comfort for both you and your pillion passenger. With this seat combination, you can tackle the longest, most challenging and demanding journeys, whether you're riding alone on your machine or not. You can also order pillion and rider's seats individually - both seats can be fitted in combination with the series models and fitted with no problem at all. Design, material, cushioning and finishing have combined to create truly superlative products which will considerably increase the pleasure you take in riding your machine.

Wherever you are in Africa, South America or on your own home ground.

044-5904	Rider's seat standard	51/53 cm
044-5905	Rider's seat high	54/56 cm
044-5910	pillion passenger	



## Sports Seat FRESH TOUCH

BMW R 1200 GS / ADV

The integral bucket shape seat platform increases riding comfort considerably both for the driver and the pillion passenger. Last but not least this is due to the fact that it offers more freedom of movement. This seat looks great and stands out by its top finish and high-quality materials. We can offer you the Touratech sport seat for your R 1200 GS in two heights: standard (as the original one) or high (about 3 cm higher than the original seat). For all 1200GS models!

044-5963	Sport seat standard	54 cm
044-5964	Sport seat high	57 cm



Tests in Namibia, Bolivia and Mexico have led to a great increase in comfort in hot weather.

## Sports Seat Dri Ride \*breathable\*

BMW R 1200 GS / ADV

044-5916	standard	54 cm
044-5917	high	57 cm







## Touratech Suspension

### BMW R 1200 GS / ADV (2004-2013)

Many advantages to other High-End brands! Touratech Suspension has been designed by Tractive Suspension. Tractive has specific, profound expertise of the Touratech type of motorbike models. As an example, the people at Tractive designed most of the shocks used by BMW Motorrad since the last 10 years. They therefore understand the specific user and reliability requirements as no one else does. The shocks were developed for traction, comfort, dynamic safety, reliability and light weight. Each shock suspension was tested with Touratech customers in mind. The shocks have been successfully tested on durability 4 times stricter than the original BMW standards. Detailed information on Touratech Suspension and available variants can be found starting on page 596!



BMW Type:	Level 1	HighEnd
R 1200 GS Rear (2004-2010)	044-5860	044-5865
R 1200 GS Front (2004-2012)	044-5875	
R 1200 GS Rear (Low approx. -50 mm) (-2012)	044-5861	044-5866
R 1200 GS Front (Low approx. -50 mm) (-2012)	044-5876	
R 1200 GS ADV Rear (2006-2013)	044-5862	
R 1200 GS ADV Front (2006-2013)	044-5877	

BMW Type:	Level 2	Extreme
R 1200 GS Rear (2004-2010)	044-5880	044-5870
R 1200 GS ADV Rear (2006-2013)	044-5882	044-5872
R 1200 GS ADV Front (2006-2013)		



## Touratech Suspension progressive replacement springs for front and rear shock absorber

**BMW R 1200 GS / ADV**

This set of progressive replacement springs has been designed to match the BMW R1200GS perfectly, and offers a "tremendous improvement" in response and greater safety in extreme situations. Replacing the front and rear springs will lead to a significant improvement and more riding pleasure with your motorbike.

**040-7439** R1200GS (2004-2005) WP

**040-7440** R1200GS (2004-2012)

**040-7441** R1200GS ESA (2007-2010) Showa

**040-7442** R1200GS ESA (2010-2012) WP

**040-7443** R1200GS ADV (2006-2012) Showa

**040-7444** R1200GS ADV ESA (2006-2010) Showa

**040-7445** R1200GS ADV ESA (2010-2013) WP



## Touratech Suspension steering damper CSC

**BMW R 1200 GS / ADV (2004-2013)**

The Touratech Suspension CSC steering damper effectively optimises ride stability on the BMW R 1200 GS / ADV - whether for off-road and touring use carrying a heavy load or while chasing curves. Trials and experience show that the linear Touratech Suspension CSC (Constant Safety Control) steering damper with its permanent assistive effect adds a whole new dimension to riding. Depending on individual requirements, the damping can be adjusted very finely through 24 clicks to suit the riding conditions. There is a distinct improvement in ride dynamics when carrying heavy luggage with touring equipment, over long distances, on the worst roads and/or on dirt tracks. Fitting the CSC steering damper makes the bike's ride and handling significantly more stable, less tiring and safer.

**044-5858**



### Touratech Suspension front shock absorber Typ Extreme

This Extreme shock absorber ranks in the absolute premium class of suspension components. For even the most extreme conditions. It features PDS, which utilises a second damping piston to provide hydraulic protection against bottoming out. Even fully loaded with luggage under the harshest off-road conditions, the bike will not bottom out and the shock absorber is protected against mechanical overload. Damping characteristics change depending on the road surface. Under most riding conditions, the shock absorber is comfortably adjusted for a less strenuous ride, before the PDS kicks in for the last portion of the shock absorber stroke. At the same time, the strengths of the Telelever system are reinforced by the fine response characteristics of this Touratech shock absorber. The high speed and low speed damping settings allow an extremely fine degree of control to satisfy your ride comfort requirements.

BMW R 1200 GS (2004–2012)

044-5886

BMW R 1200 GS ADV (2006–2013)

044-5887

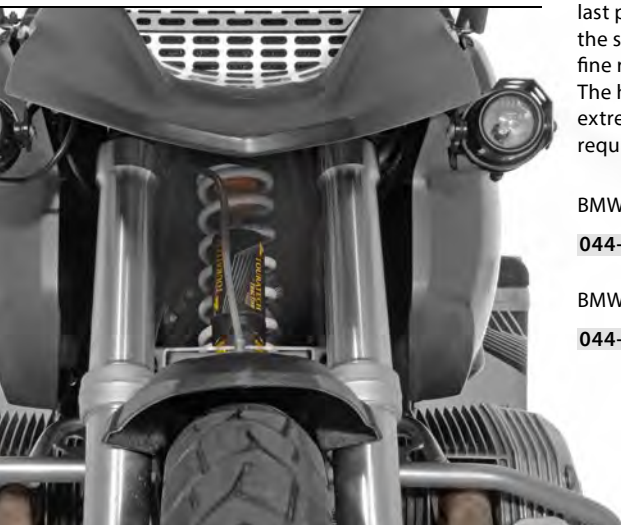



FRONT



REAR



FRONT



REAR

### Plug & Travel ESA Expedition SET

- PDS - travel-dependent damper piston: hydraulic bottoming out protection using a second damper piston, i.e. no bottoming out of the shock absorber
- Separately adjustable high and low speed damping, for precise damping setting at very high damping frequency and under heavy use (bad roads, trails carrying luggage)
- Piggyback-reservoir on the shock absorber for improved cooling performance of the shock absorber oil and higher damping performance under heavy use



# SAME BUTTON – BETTER RIDE

## Touratech Suspension Plug & Travel ESA SET

### BMW R 1200 GS

This Plug & Travel ESA suspension system for the BMW R 1200 GS is a robust replacement for the BMW standard ESA suspension system. The BMW ESA buttons function in the same way as before, but the ride characteristics are a great deal better. The Plug & Travel ESA shock absorbers have been specifically configured for the original BMW ESA equipment of your BMW R 1200 GS with the same ESA ride modes, top performance and the finest of suspension system technology for your BMW R 1200 GS. The BMW ESA shock absorber simply replaces the complete BMW ESA shock absorber. The existing plugs and switches on the handlebar are used as usual. Thus the Touratech suspension shock absorber is integrated into the motorcycle using the original BMW controls.

### The main features and facts of the Plug & Travel shock absorber:

- The Plug & Travel ESA suspension system configured ready for installation ,Out of the Box'
- Special Touratech-Plug & Travel setup for balance, damping and rebound
- The Plug & Travel ESA shock absorbers are connected to the original plugs
- Unique, robust, electrohydraulic Touratech ,Extreme' spring pre-tension
- Integrated in the shock absorber, the unique Touratech Plug & Travel stepping motor for damping adjustment
- All components are operated by the BMW control unit and are integrated in the motorcycle
- Operation using the original BMW ESA button remains unchanged
- The same ESA button with substantially better effect
- Identical BMW ESA ride modes with better ride dynamics
- Display of the BMW ESA ride modes in the familiar manner on the BMW display

**The complete BMW ESA replacement suspension system for more riding pleasure & safety at the touch of a button.**

	Plug & Travel ESA SET	Plug & Travel ESA Expedition SET
BMW R 1200 GS (2007-2010)	044-5822	
BMW R 1200 GS (2007-2010)		044-5890
BMW R 1200 GS ADV (2007-2010)	044-5828	
BMW R 1200 GS ADV (2007-2010)		044-5892
BMW R 1200 GS (2010-2012)	044-5825	
BMW R 1200 GS (2010-2012)		044-5891
BMW R 1200 GS ADV (2010-2012)	044-5833	
BMW R 1200 GS ADV (2010-2012)		044-5893



### **Petrol Line Protection**

**BMW R 1200 GS**

Braking down on a trip because of a small technical defect is really annoying - and it happened to us. On a steep incline a boot was pushed out just a little too far - and broke off the plastic connectors for the petrol lines. To prevent this ever happening again to us (and of course to you!) we have created suitable, robust V2A protection for the 1200 off-road Boxer. For all years of construction.

**044-0405** for both sides

### **Decal Set Fork**

**BMW R 1200 GS / ADV (-2013)**

Absolutely strong, thick film protects the fork against stones, and other types of damage. Black film with white print.

Very easy to apply - strong adhesive.

**044-3014** for both sides

### **Universal Tube Manifold Cover (Left and Right)**

**BMW R 1200 GS / ADV**

Protects the bike from stones being thrown up and heavy soiling. Also the appearance of the bare pipe is enhanced. The manifold cover is made of high grade steel.

Parts supplied: 2 pieces, incl. 4 pipe clips.

**044-0132**



## Cylinder Protection Alu special

BMW R 1200 GS | ADV (2010–2013)

Combination of stainless steel and anodised aluminium to effectively protect the cylinder cover in the event of a crash or accident. Also effectively prevents the valve cover from moving in the event of a crash.

047-0162 black



## Oil Cooler Protection

BMW R 1200 GS / ADV

The oil cooler on the R 1200 GS is also unprotected in the standard model. This protector is made of black aluminium. It is effective not only against stones, but also against the countless small insects which otherwise become trapped in the cooler. The radiator cover can cause the engine to over-heat under extreme conditions with high outside temperatures and an extreme engine load. For all R 1200 GS!

044-0342 black

R 1200 GS / ADV AC

## Guard for throttle position sensor V2.0

BMW R 1200 GS / ADV

Advantages of the V2.0:

- third attachment point for maximum reliability
- Optimised shape for even greater protection of sensitive clothing/boots
- Additional rubber part for even greater protection of sensitive clothing/boots

044-0736 black





## Fairing Crash Bar Stainless Steel

### BMW R 1200 GS (2008–)

Your GS engine is already perfectly protected with our crash bar (051-0560 & 044-5160)! But what would happen to the damageable and expensive plastic side sections of the tank fairing and the stainless steel shielding at the front if the worst came to the worst? The Touratech fairing crash bar prevents costly damage to the exposed parts of the fairing and eliminates the risk of those perpetually annoying scratches!

- Made of electro-polished stainless steel for a really classy look that matches any motorbike paintwork
- The outstanding quality of the alloy means no flaking of the coating and no corrosion in the event of minor damage to the crash bar
- Well drawn-back tubular construction for extensive protection of the side sections
- The elegantly curved design cleverly embodies the style of the R 1200 GS

- Forces triggered by a crash or the motorbike falling over are absorbed and diverted to the specially intended points without causing any major damage
- The generously dimensioned cross-sections protect the rider and motorbike even in a head-on collision
- Stable, multi-position attachment with high-tensile clamping to the engine crash bar and bolting at the front
- Lends the R 1200 GS an aura of ADVENTURE
- Can also be mounted together with the Touratech LED, fog and xenon headlights as well as the Touratech daytime running lights
- can only be fitted in conjunction with our crash bar (051-0560 & 044-5160) and the original BMW crash bars
- For all BMW R 1200 GS models (2008-)

044-5161



## Valve Cover Protection "Sport"

Our "Sport" valve cover protection emphasises the sportiness of the boxer bikes, and protects the delicate exposed valve covers against damage. The protection is easy to fit, and made of special high-strength plastic. This prevents damage in the case of falls and doesn't spoil the bike's overall look, as an extensive roll bar would. For all BMW R 1200 models up to 2009.

610-0300 (-2009)





## Crash Bars Stainless Steel

### BMW R 1200 GS

These crash bars have been adapted specially for the R 1200 GS design. The lines and forms of the refined boxer engine have been used again and incorporated beautifully into the whole appearance of the motorcycle. In spite of the fact that they are so good to look at, they are certainly one of the best crash bars on the market because with these crash bars not only is the cylinder protected but also the engine housing stabilised in quite a special way because of a bridge construction with a "pre-determined point of inflection". As a result, in most falls there is not such a great strain on this fastening

screw thread and the engine housing remains intact - it would, of course, be a shame if the valve cover was protected but the engine housing destroyed. The connecting bar is also very robustly designed because of additional supports on the main frame and can take such greater stresses and forces. The crash bars are made of non-rust stainless steel. The R 1200 GS really needs this high-quality, refined material. It is very easy and quick to fit. Most necessary maintenance work can be done without removing the crash bars.

051-0560





## Kick Stand Support Extension

BMW R 1200 GS

With this kick stand support extension the R 1200 GS stands much more firmly even on quite a soft surface. Even if you park the motorbike in a meadow you do not always have to look for a small plank of wood or another base. This practical part is made of a combination of stainless steel laser parts and anodised aluminium. Quick and easy to fit.

044-3030 (2008-)



## 4 mm Plate for Kick Stand Support Extension

By using this plate you can control the kick stand angle. Three different screw kits are included so that 3 plates (total height 12 mm) can be fitted. Simply control the height by selecting the required number of plates.

044-3033 BMW R 1200 GS / ADV (2008-)

Accessory for 044-3030



## Oil filler cap with hexalobular internal T50

BMW R 1200 GS / ADV

Ingenious and high quality - fantastic protection against foreign bodies in the oil circuit of your R 1200 GS. Made of aluminium, CNC turned (anodised) and with hexalobular internal to open it. The cap is simply used instead of the original plastic part and can then only be opened with a TORX 50 key.

045-5230



## Locking Oil Filler Cap

BMW R 1200 GS / ADV

Stolen oil filler caps are a thing of the past. No special tool required: easy to operate using a small unobtrusive key.

- High-quality workmanship
- High-quality brand lock
- Can be keyed to match our integral pannier locks

044-0210

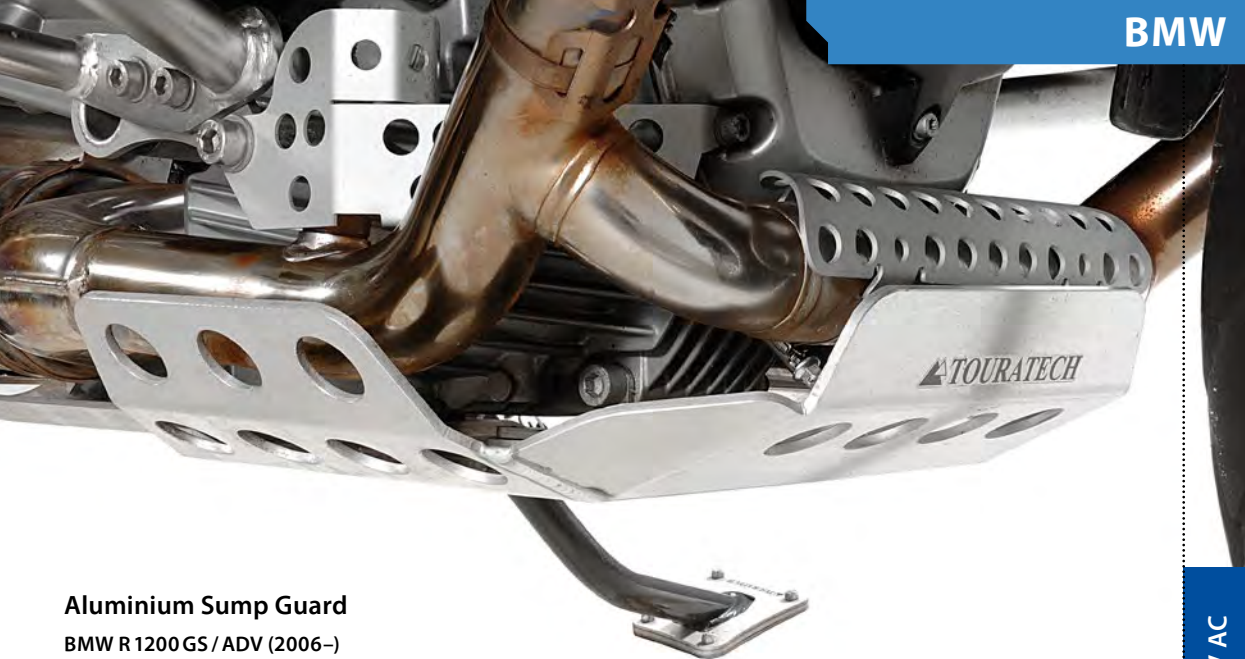

## Aluminium Sump Guard

BMW R 1200 GS / ADV (2006-)

As it is perfectly suitable for the terrain the R 1200 GS constantly invites you to go on extensive off road trips. So that this remains an unalloyed pleasure, we have developed a sump guard especially for the R 1200 GS. Any knocks or impact are distributed over the whole engine block so that the engine housing is protected in the best possible way. When used on rough terrain the bike can slide much more easily over stones, rocks and uneven ground because of the angled shape of the front of the sump guard.

044-0722 alu

044-5135 black



## Drive Shaft Crash Bungs

BMW R 1200 GS / ADV

A small item that can make a big difference! Our crash bung protects the drive shaft against expensive damage in the event of a fall. Thanks to its solid construction, the crash bung absorbs the forces and reliably protects the drive shaft tunnel against damage caused by contact with the road surface.

044-5505





## Long-distance foot pegs WORKS with ABE

### BMW R 1200 GS / ADV

- 52 mm wide and 4 mm thick stainless steel claw profile that is kind to your boots
- Perfect combination of grip and self-cleaning
- With a more slender design for better ground clearance
- Significantly less susceptible to impacts
- Strengthened mounting point
- With a blasted surface and laser inscription for a superior finish

044-5315

044-5316 low

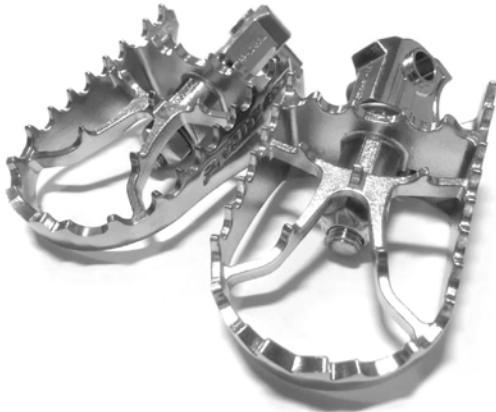

## Pivot Pegz MARK 4

### BMW R 1200 GS / ADV

**Now with 6 cm wide and 10 cm long tread for even better grip!**

An absolute breakthrough - and not just for cross-country and enduro riders who bemoan the lack of sensitivity of the original pegs. Thanks to a spring joint, these foot pegs follow the forward and backward movements of the foot to an angle of 20 degrees. This protects the boot, and gives the rider a better position on the bike - even in extreme situations. It also minimises the load on the rider, since the boot is almost always positioned on the full surface of the peg and not - as with the conventional peg - on the edge. This is particularly tiring and dangerous, especially off-road.

040-5520

040-5525 Toppers



## Internal bag for toolbox

### Organise your travel toolkit!

The internal bag was especially developed for our toolbox for the BMW R 1200 GS Adventure. It is robust with a high-quality finish, and includes loops to hold your tools. When folded out, the tool bag is the perfect mat for roadside repairs - you will never have to look for disassembled small parts in the dirt again!

Dimensions approx.: 7 x 30 x 10/14 cm

Also for universal use. Supplied without tools.

055-5611



## Touratech BMW motorcycle toolset, 70 PCS

### BMW R 1200 GS / ADV

The professional tools for your BMW motorcycle. A lot of great ideas and many impressive patent tools has been put into this one to ensure that we are always innovating for the better. The dream set for your road trips and any repair works you encounter.

All the tools are made with the best quality materials, S2 Bits with Black Phosphate finishing anti-rust. Cr-V Satin Chrome Plated sockets and spanners.

MIT (Metric/Inch/Torx): The MIT tools work on various type of nuts: Square, 6 or 12 points, Star, Spline and damaged.

070-2211



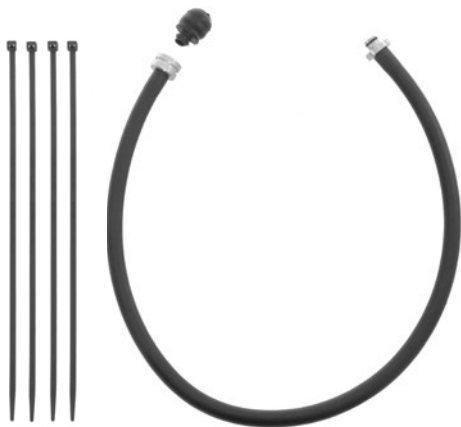

## Relocation Cardan Ventilation

### BMW R 1200 GS / ADV

Riding a GS through deep water - no problem. Unfortunately not!

A small and inconspicuous valve at the cardan housing ensures the necessary ventilation and pressure exchange. If the valve gets dipped under water, moisture can get into the housing and damage the whole drive. The solution of the problem: relocating the cardan ventilation valve to a protected position. Due to two robust connectors made of lathed aluminium and a durable hose, the valve will be repositioned in a very easy way.

A MUST HAVE for every long-distance journey!

045-5506

## Charger „Compact Worldwide“



Suitable for BMW CAN bus. Super-compact charger, extremely easy to use, also suitable for all CAN bus motorcycles such as the R 1200 GS, F800GS, etc. simply plug into the existing onboard power socket, and that's it! Charges the battery on CAN Bus motorcycles even when ignition is switched off. Maintenance charging function and charge state LED - 5 m cable and Onboard power supply plug with 4 interchangeable plugs for EU, UK, USA and AUS IN: 100-240 V; 50-60 Hz; 550mA & OUT: 12 V; 1.66A - Also suitable for many other motorbikes with lead, lead gel and maintenance free batteries. TIP: Can be used on your motorbike, too, with our "onboard socket add-on kit with fuse"!

130-0014

## TPS 15 for BMW CAN-BUS 15A relais switch

With this practical little helper you can also connect various electrical devices, such as a tent light, compressor or battery charging unit (maximum 5 up to 15 A), to the complex R 1200 GS CAN bus system and operate these easily without the on-board electronic system being switched off automatically. Fits all BMW with (single-wire) CAN-BUS, e.g. R 1200 GS, F800/650GS, etc.

044-0450

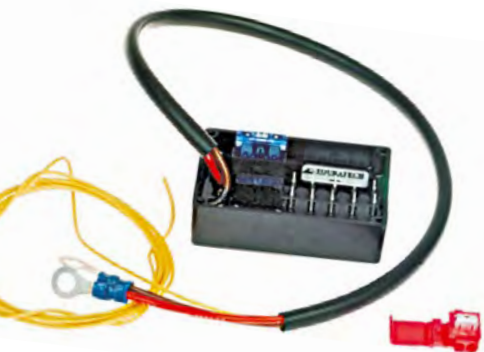

## Dual USB Plug-n-Play socket

### for BMW motorbikes

Let's be honest: Do you really use the DIN socket on your BMW? Simply replace it with the much more useful double USB socket! Charge your smartphone, camera, GPS, etc. without adapter while driving!

- Input voltage: 10 to 40 V
- Output voltage (USB ports): 5 V +/- 5%
- Output overvoltage, overheating and short-circuit protection
- Fully CanBus compatible
- Total 3.3 Amp output, with current limiters per port (master port 1: 2.3 A / Aux port 2: 1.0 A)
- Intelligent device recognition: detects if Apple (meets MFi standard) or Android (BC1.2).
- Weatherproof: independent port rubber covers
- Plug compatible with BMW motorcycle DIN socket installation

030-0084



R 1200 GS / ADV AC



### BOXER OIL 4T 15W/50

- Specially designed for the requirements of air/oil-cooled engines
- Synthetic Performance MC "Molecularly Converted"
- Developed and tested in co-operation with AC Schnitzer
- Noticeably improved engine response
- Lower internal friction reduces consumption and wear
- Special additive package for lower evaporation loss (NOACK) reduces oil consumption
- Excellent temperature stability and high pressure absorption
- JASO MA specification means it is also suitable for all other BMW engines
- The oil for all engines by this manufacturer
- Specifications: JASO MA - API SL, SJ, SH, SG

400-0166 1 litre







## Tank bag Ibarra

BMW R 1200 GS / ADV

The "Ibarra" tank bag has been specially designed for big trail bikes and large space requirements. With its foamed base plate, it sits precisely and securely on the tank. Thanks to a stable base made of high-quality textile fabric, the Ibarra retains its shape in all situations. The upper material is water-repellent and abrasion-resistant.

With its large main compartment, two zipped outer pockets and detachable map pocket in DIN A4 size, the Ibarra offers enough volume even on long tours.

The expansion zip allows for additional storage space. The all-round zip provides easy access. Like all Touratech tank bags, the Ibarra can also be fitted or removed in seconds with click fasteners.

Elasticated straps with quick-release fasteners, YKK brand zips and reflective sections by 3M round off these high-quality features.

Dimensions: (L x W x H) approx. 35 x 26 x 18/25 cm;  
Volume: approx. 14/22 litres.

055-1281





## Handlebar bag "Ibarra"

BMW R 1200 GS / ADV

The sturdy handlebar provides enough space to attach an extremely practical and travel-worthy bag. A wide opening water-repellent dustproof zip provides easy access to a large main compartment in which the things you need quickly - a first aid kit, spare pair of gloves, breakdown kit or also your

travel documents, wallet, sunglasses and mobile phone - are well protected.

A key feature is that our bag doesn't in any way restrict the rider's movements or affect control of the bike.

044-5827

Photo: Matthias Grill





## Bag AMBATO for the Luggage Rack

### BMW R 1200 GS

Doesn't get in the way and is unbeatably useful! There is plenty of room on the original luggage rack for a strong, practical bag. It is perfect for storing waterproofs, spare gloves, tools and small amounts of shopping safely and out of the weather. Of course, this in no way impairs the passenger's comfort, and because the bag is far back on the vehicle, the rider is still able to get on with ease. The pannier slides onto the luggage rack from the back, is secured at the front with two straps, and the special base plate ensure that it remains safely in place. This is also a perfect ready-to-travel addition to the existing storage space!

Size: (L x W x H)

approx. 17 x 27 x 12/20 cm

Volume: approx. 4/8 litres

055-1298

## Additional pannier top bags AMBATO, (1 pair)

### for original plastic panniers BMW R 1200 GS

Size: (L x W x H) approx.

ca. 46 x 24 x 13/23 cm

Volume: approx. 2 x 10/2 x 15 litres

Colour: black

044-5810





## Crash bar bags AMBATO

### BMW R 1200 GS ADV

A brilliant bag for rain cover, spare gloves etc. the bags are just put over the tank bracket and fixed in place with 2 straps.

055-1131



## Toolcase / ZEGA Cases

### BMW R 1200 GS | ADV

New cube-shaped toolcase made of Cordura Teflon Mix. This robust toolcase has an incorporated belt for securing the tools. This clever feature is very useful on offroad trips - it effectively prevents the tools or other heavy objects from sliding around in the case. Besides tools and other objects, you can also pack your rain outfit and food for the trip into the case. The volume of this extremely robust toolcase can be doubled with a simple zipper and the case fits perfectly on the TOURATECH ZEGA Cases and the R 1200 GS Adventure Case. The bag also fits on the luggage racks of many Enduro models (incl. the KJM LC8 Adventure and the BMW F 650 GS). Two side pockets for various utensils/tools and a small luggage net make this case a multi-talented must-have. Available in two colours.

Dimensions: (L x W x H) in cm: 35 x 18 x 15/25 (expanded).

050-0803 black 6/12 L



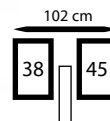
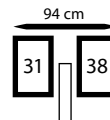

# ZEGA

## Pannier Rack

### BMW R 1200 GS/ ADV

The robust pannier rack is made from 18 mm steel tubing and is black powder-coated or stainless steel. Using special fixing clips, the pannier rack is attached to the rack tail and existing mounting points. Very robust construction with crosspiece which also copes with tough off-road tours and yet elegantly matches the overall appearance of the R 1200 GS. Delivery schedule: pannier racks with all attachments and mounting hardware

051-0134



# ZEGA

## ZEGA MUNDO

## ZEGA PRO

## ZEGA EVO



More information  
about ZEGA cases  
from page **>436**

### ZEGA Aluminium Pannier System

#### BMW R 1200 GS / ADV

The aluminium pannier system again has a very robust construction. We have tried to bring the pannier racks and the panniers as close as possible to the motorcycle. Numerous tests have already been performed in order to ensure that the entire development satisfies the required demands. The rack is made of 18 mm steel tubing and is attached to existing mounting points using special fixing clips and reinforcing pieces. Pillion comfort not restricted in any way.

Enhances the enduro and touring appearance of the R 1200 GS (overall width: 94/102 cm). And-S: anodised aluminium case.

For further information on ZEGA Cases and accessories please have a look at pages 436 et seqq.

	stainless steel rack
ZEGA Mundo 31/38 L	044-6130
ZEGA Mundo - 38/45 L	044-6135
ZEGA Pro 38/45 L	052-3007
ZEGA Pro AND-S 38/45 L	052-3008
ZEGA Pro AND-Black 38/45 L	052-3010



## Locks for ZEGA Pro Panniers

Supplied as sets of two or four keyed alike locks so you need only one key per pannier system or pannier. You will need two padlocks per pannier. These installation locks are only suitable for ZEGA Pro / ZEGA Pro2 / ZEGA Mundo.

### Integral locks set for ZEGA Pro / Pro2 / Mundo with 2 simultaneous locks

050-0872

### Integral locks set for ZEGA Pro / Pro2 / Mundo with 4 simultaneous locks

050-0874

For ZEGA Pro accessories please have a look at page 480 et seqq.



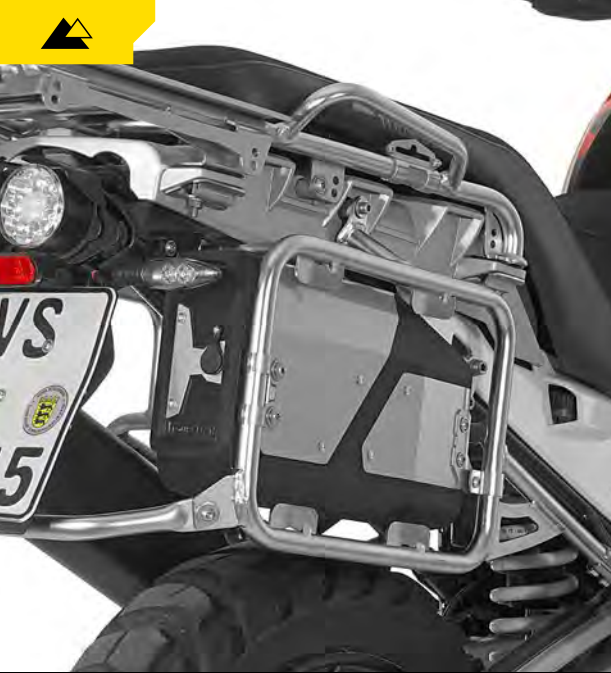

#### Note:

#### Toolbox for original stainless steel pannier rack BMW

- BMW R 1200 GS (2004 – 2012)
- BMW R 1200 GS Adventure (2006 – 2012)
- BMW R 1200 GS (2013 –)
- BMW R 1200 GS Adventure (2014 –)



#### Toolbox for original case carrier

##### BMW R 1200 GS / ADV

The Touratech tool box is the ideal solution for the safe storage of small items on your GS. The optimal utilisation of space on the vehicle allows tools, first-aid kit, breakdown kit and many other useful items to remain on the motorcycle permanently and without interfering. They are always readily accessible, even when the cases are not mounted. The approx. 4.2 litre large storage space is protected against spray water and a large opening makes loading and unloading easy, even when the cases are mounted. The lid can be removed completely for easier loading, a safety mechanism prevents loss. The toolbox was developed specifically for the original BMW case carriers and matches the GS in materials and design. The perfect combination of stainless steel and plastic provides optimal stability and a look that is difficult to beat. Even if the cases are not mounted, it is an absolute eye-catcher! Using special clamps, the box can be mounted to the case carrier easily and very quickly. A protection cap on the lock against spray water provides permanent ease of use.

- quality „Made in Germany“
- lockable and resistant
- important small items are always readily accessible
- optimal utilisation of space on the vehicle
- protected against spray water

Dimensions: 33 x 9.5 x 19.5 cm

Volume: 4.2 liters

Material: plastic, stainless steel

045-5610



p. 157

#### Internal bag for toolbox

Dimensions approx.: 7 x 30 x 10/14 cm

Supplied without tools.

055-5611



## ZEGA Evo / ZEGA Pro Topcase Rack

The special carrier for our ZEGA Evo / ZEGA Pro Topcases

Made entirely of stainless steel and specifically designed for the BMW R 1200 GS attachment points, the topcase rack is the perfect way to attach ZEGA Pro topcases to your bike. The topcase rack can be used on its own or in conjunction with our pannier system.

044-5455



## ZEGA Evo / ZEGA Pro Topcase

The ZEGA Pro and ZEGA Evo Topcase offers all of the same advantages as are found with our tried and tested ZEGA Pro and ZEGA Evo panniers! Absolutely waterproof Topcase made from rugged, polished aluminium with protective corners! On the lid are four top loops for attachment the luggage.

Dimensions:

25 Litre Topcase (L x W x H): 315 x 400 x 180 mm

38 Litre Topcase (L x W x H): 315 x 400 x 300 mm

(helmet fits in!)

### ZEGA Pro Topcase

050-0680 38 Litres

### ZEGA Pro AND-S Topcase

050-0682 38 Litres

### ZEGA Pro AND-Black Topcase

050-0683 38 Litres

### ZEGA Evo AND-S Topcase

050-6066 25 Litres

050-6076 38 Litres

### ZEGA Evo AND-Black Topcase

050-6067 25 Litres

050-6077 38 Litres

ZEGA Pro



ZEGA Evo



ZEGA Evo





# ZEGA EVO





### ZEGA Evo Aluminium pannier systems with stainless steel rack

The ZEGA Evo, like all Touratech panniers before it, was not developed as an isolated product but was intended from the outset to be part of a luggage system. The outstanding practical benefits are the result of the unique combination of an elegant and indestructible pannier, an ingenious fastening mechanism and a terrain-immune rack made of 18 mm thick stainless steel tubes. Matching inner pannier bags and practical accessory holders round off the luggage system.

- Newly designed plastic corners - protect driver and pannier in the event of an accident
- Proven fixing pins - for ZEGA Evo accessory holder
- Proven handle - for comfortable carrying
- Newly developed fastening system - for easy mounting and secure hold on the pannier rack
- Newly developed lockable one-hand locking system - for convenient and secure attachment to the pannier rack
- Newly developed lockable lid catch- for convenient opening and closing from both sides, thanks to practical hinge function
- Proven silicone seal - for a pannier that's dry on the inside, even in the pouring rain
- Proven attachment eyes - for secure fastening of pannier lid bags and other soft luggage
- Standard hooks on the inside of the lid - for attaching accessories (bags, nets)

Pannier System with:	stainless steel rack
ZEGA Evo AND-S 31/38 litres	<b>044-6831</b>
ZEGA Evo AND-Black 31/38 litres	<b>044-6832</b>

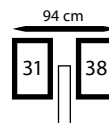

Pannier System with:	stainless steel rack
ZEGA Evo AND-S 38/45 litres	<b>044-6836</b>
ZEGA Evo AND-Black 38/45 litres	<b>044-6837</b>

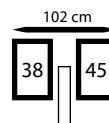

# FULLY EQUIPPED

ADVENTURE MOTORCYCLES

BY TOURATECH



## WORLD TRAVEL EDITION

TOURATECH

BMW R1250GS | ADV

Fully Touratech-equipped  
new vehicle with full  
BMW warranty.

Price on request





NEW IDEAS FOR MOTORBIKES

**TOURATECH**



# WORLD TRAVEL EDITION

**TOURATECH**

**Yamaha Ténéré 700**

Fully Touratech-equipped  
new vehicle with full  
Yamaha warranty.

Price on request

Find our bikes at [mobile.de](http://mobile.de)



*For more details  
please contact:*

[CUSTOMIZE@TOURATECH.DE](mailto:CUSTOMIZE@TOURATECH.DE)



NEW IDEAS FOR MOTORBIKES

**TOURATECH**



- 1 Handlebar | Cockpit | Windscreens | Lighting from p. 176
- 2 Foot pegs from p. 181
- 3 Engine guard | Cylinder protection | Fairing from p. 182
- 4 Suspension from p. 184
- 5 Tank bags from p. 188
- 6 Tail rack bags from p. 191
- 7 Pannier systems from p. 197



# BMW

F 850 GS

F 750 GS





082-5256

## Handlebar riser joined, with ABE

BMW F 850 GS / ADV

Raising the handlebar by 20/35 mm results in a more upright, much more relaxed seating position. The adjustment range of the handlebar angle is increased, which further increases rider comfort. The Touratech handlebar riser also makes riding while standing less tiring, which is of tremendous benefit to taller riders in particular. Not suitable for BMW F750 GS!

082-5255 20 mm

082-5256 35 mm



## Set of special screws for original BMW navigation device holder and smartphone Cradle on Touratech handlebar riser

BMW F 850 GS

082-5415 for 20 mm

082-5416 for 35 mm



## GPS handlebar bracket above the instruments V2.0, height-adjustable

BMW F 850 GS / ADV | F 750 GS

In order to position a GPS unit on the F 850 GS so that you can see it properly we have developed a sturdy stainless steel bracket adapter for nearly all Touratech GPS handlebar brackets. You can thus position your GPS unit properly above the instruments of your F 850 GS. This bracket adapter is incorporated into the front part of the F 850 GS. The bracket is wide enough for you to be able to position a GPS unit, for example, wherever you want. The height adjustment prevents the instruments from being covered by the GPS. For more than just for Touratech GPS handlebar brackets!

..... 082-5414



## GPS Handlebar Bracket Adapter

BMW F 850 GS / ADV | F 750 GS

The bracket adapter is simply fitted to the handlebar mounting clamps on your BMW. Our GPS brackets all fit perfectly on its 12 mm brace. For easy, safe attachment of your GPS. With no impairment of the view of the instruments.

082-5410

## GPS handlebar bracket adapter with screws for handlebar risers

082-5411 for 20 mm

082-5412 for 35 mm





## Windscreen, with ABE

### BMW F 850 GS / ADV

Not satisfied with the original wind shield of your bike? Thanks to countless miles of adventure experience and to the know-how of our production department, we developed a wind shield that unites an appealing adventure design and an optimal function for every application. Replace your original windscreen with the Touratech wind shield and discover much better

driving properties! The form and function of the upper edge of the windshield is based on our rallye experience. The aerodynamic optimization guides the air streams over the head of the pilot without unnecessary turbulences. So, the wind shield is not only flatter-free, it also guarantees a relaxed driving pleasure that doesn't exhaust the pilot nor the pillion passenger.

**082-6220 L, transparent**

**082-6222 L, tinted**



## Windscreen spoiler Evo, with ABE

### BMW F 850 GS / ADV | F 750 GS

Whether you need it for your original windscreen or as accessory to your new Touratech windscreen - with Touratech's windscreen spoiler Evo, you absolutely gain extra comfort on each terrain.

Evo offers the right balance between protection and ventilation - whether you drive on motorways, roads or off-road. Height, inclination and distance to the windscreen can easily be adjusted - you do not need any tools.

If you are going fast and the weather is rainy, fasten the spoiler at its highest level to benefit from an effective wind and weather protection. It is a noticeable relief for your head and upper body, and wind noises in your helmet are significantly reduced.

If you set the lowest level, the windscreen spoiler almost disappears. This guarantees maximum ventilation when riding off-road.

**040-1380 transparent**

**040-1381 tinted**



### Set of LED Auxiliary Headlights

BMW F 850 GS / ADV | F 750 GS

We use innovative LED headlights of 70 mm diameter for our auxiliary headlights.

The excellent light output is made possible by the latest lighting technology and high-performance LEDs with a higher level of efficiency. Power consumption just 13 watts per headlight! (Halogen: ~55 watts)



### Set of LED auxiliary headlights fog / fog

For the combination with Touratech crash bars.

082-5472

### Set of LED auxiliary headlights fog right / full beam headlight left

(Not suitable for special model with original BMW LED headlight!)

For the combination with Touratech crash bars.

082-5473



**OFFROAD  
USE ONLY**

### Headlight protector for original BMW LED „Nano“ headlight

BMW F 850 GS / ADV | F 750 GS

038-5468 (2017-)

### Spoiler for Original BMW Hand Protectors

BMW F 850 GS / ADV | F 750 GS

Optimal hand protection for the original protectors. Very useful and pleasant in rain, snow, hail and cold. The spoilers are made out of resistant and light synthetic. Easy to fix!

Very useful accessories for the GS-biker.

045-5665 (Set)

045-5666 (Set) white

045-5667 (Set) red

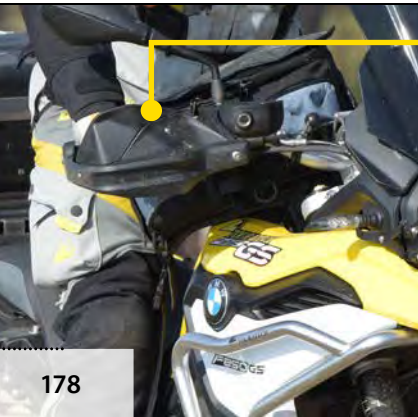



### Touratech brake and clutch lever set, adjustable, short version

BMW F 850 GS / ADV | F 750 GS

CNC machined high-tech lever in the short version about 17cm long and are therefore ideal for the so-called „two-finger brake system“.

High-strength aluminum (material: T6063 T6), which is also used in aircraft construction, milled from solid, weight only about 250 g (both sides).

We use a high quality anodization process which is tested for longevity and corrosion resistance.

The levers are adjustable by means of adjusting lever 6-fold at a distance to the handlebars.

082-5641



### Touratech brake and clutch lever set, adjustable, folding and length adjustable

BMW F 850 GS / ADV | F 750 GS

The Touratech levers are milled from high-strength aluminum as in aircraft construction from the full. They are 6-way adjustable and hinged. In case of a fall the lever can fold up without breaking. In normal operation, the levers are protected by a fold-up mechanism.

The levers are adjustable in length by dovetail connection by 35mm. The anodization meets the highest quality standards. All screw connections comply with the DIN standard and are tightened before delivery with the torque wrench.

The CNC levers are delivered with German ABE (General Operating Permit) and are therefore registration free.

082-5640



### Headlight Protector with Quick Release Fastener for LED Headlight

BMW F 850 GS / ADV | F 750 GS

Our headlight protector has been thoroughly tried and tested over the years – we've sold thousands.

Even the biggest stones won't be able to damage your headlight with this!

The new durable stainless steel model is now available with quick release fastener! Now you can clip on the headlight protector and detach it again as needed. Just bolt the sturdy and secure side struts. And of course the protector comes with everything you need to fit it. The headlight protector has been developed for off-road use and is not permitted in the scope of German StVO. Please check your national regulations!

#### Headlight protector Makrolon

082-5090 F 850 GS | F 750 GS

082-5091 F 850 GS Adventure

#### Stainless steel black headlight protector

082-5095 F 850 GS | F 750 GS

082-5096 F 850 GS Adventure

OFFROAD  
USE ONLY



## Side stand base extension

BMW F 850 GS / ADV | F 750 GS

The side stand base extension more than doubles the area of the supporting surface, so you won't find yourself straining to lift the fully loaded machine.

082-5275 F 850 GS | F 750 GS

082-5276 F 850 GS Adventure



## Rear brake fluid reservoir guard

BMW F 850 GS / ADV | F 750 GS

Made from laser-cut stainless steel, Touratech's brake fluid reservoir guard effectively prevents damage and undesired access to the reservoir lid, yet you can still easily see the fluid level.

048-5031

## Diagnostic tool Duonix Bikescan-100

for BMW motorbikes

The Bikescan-100 is small and powerful and therefore ideal for professional control unit diagnostics on BMW motorbikes. This system covers the entire motorbike electronics and makes troubleshooting much easier for the user. The many special functions and settings can be carried out directly on the device without connecting the system to a computer or laptop. Ideal for travelling.

030-0105



## Dual USB Plug-n-Play socket

Let's be honest: Do you really use the DIN socket on your BMW? Plug compatible with BMW motorcycle DIN socket installation

030-0084

## Power cable BMW CAN BUS

065-0293



### Brake lever extension

BMW F 850 GS / ADV | F 750 GS

It is particularly important when riding off-road to have the brake foot safely on the brake. Our brake lever extension will make sure that your boot always finds its way to the lever - and makes operation much easier and noticeably better.

Material: high quality stainless steel

082-5390



### WORKS Long-Distance Foot Pegs with ABE

BMW F 850 GS / ADV | F 750 GS

- 52 mm wide and 4 mm thick stainless steel claw profile that is kind to your boots
- Perfect combination of grip and self-cleaning
- With a more slender design for better ground clearance
- Significantly less susceptible to impacts
- Strengthened mounting point
- With a blasted surface and laser inscription for a superior finish

045-5315



### Pivot Pegz MK4

BMW F 850 GS / ADV | F 750 GS

Pivot Pegz MK4 now with 6 cm wide and 10 cm long tread for even better grip!

Thanks to a spring joint, these foot pegs follow the forward and backward movements of the foot to an angle of 20 degrees. This protects the boot, and gives the rider a better position on the bike - even in extreme situations.

040-5521

040-5525 Toppers



040-5521

040-5525

### Gear lever length adjustable and foldable

BMW F 850 GS / ADV | F 750 GS

Often it is just little things that are necessary to achieve the optimum ride experience. Take the original GS gear lever, for instance, the height could be adjusted but not the length. The Touratech gear lever can be adjust to your foot precisely and, due to being foldable, doesn't break off every time you tip over either. In addition, this gear lever, made from a high quality aluminium stainless steel material mix, optically upgrades your GS!

Adjustment range: 25 mm

082-5405

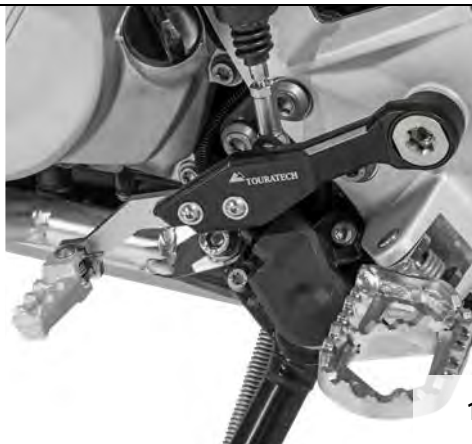



## Engine Guard EXPEDITION

BMW F 850 GS / ADV | F 750 GS

Serious damage, such as holes in the engine block, can be effectively prevented by fitting the large Touratech engine guard. Maximum strength is provided by multiple folded ridges in the 4 mm thick aluminium base plate, while an additional lower stainless steel attachment plate on the engine ensures the force of an impact is distributed over a large area via 6 bolting points. Ground clearance is not restricted by these two base plates. Another benefit is that the front of the engine guard rises up far enough to prevent damage to the oil filter and oil cooler as well. Plastic rails on the lower part of the base plate ensure that the bolt heads - which are already sunken - are completely covered.

082-5140

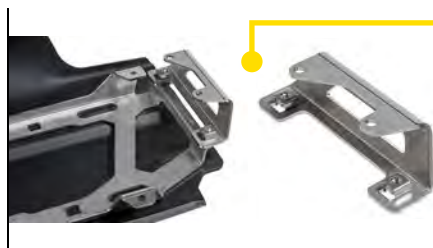

## Mounting kit for Touratech engine guard / skid plate

BMW F 750 GS

This mounting kit is required for mounting the engine guard / skid plate „Rallye“ (082-5135, 082-5136) or „Expedition“ (082-5140) on the BMW F 750 GS.

082-5139





## Engine protector RALLYE

**BMW F 850 GS / ADV | F 750 GS**  
up to 08/2020 (Euro4)

With our RALLYE engine protector we combine modern production techniques with a unique design for the best possible protection of the entire engine area of your bike!

The engine protector blends in stylishly with the lines of your motorbike. Thanks to innovative production technology, there are no disturbing welds, which are often considered to be a vulnerable point. The recesses on the underside don't only

look good. In the event of the protector having to live up to its name, they provide the shock-absorbing and lightweight aluminium with a robust stiffness. And as well as that, the two parallel recesses allow the bike to almost glide over obstacles. In this way, the energy of the impact is effectively dissipated, preventing jamming or snagging.

**082-5135**

**082-5136** black

## Stainless steel crash bar

**BMW F 850 GS / ADV | F 750 GS**

The crash bar is made of high quality, electropolished stainless steel and extends the range of use of your travel enduro. The two-component crash bar was fitted as close as possible to the vehicle to give harmonious integration into the existing vehicle

design. Its special design provides optimal force dissipation and largely protects the radiator as well as the tank and fairing against damage. The crash bar is simple to install, rust-proof and easy to care for.

**082-5161** stainless steel

**082-5163** stainless steel black

## Engine crash bar stainless steel

**BMW F 850 GS / ADV | F 750 GS**

A robust crash bar is almost obligatory to protect your new BMW F 850 GS from damage when it tips over during general use as well as when riding in tough terrain. The crash bar is made of 25 mm in diameter and 2 mm thick round tubing.

The stainless steel bar is designed to prevent your valuable motor coming into contact with the

ground in the event of a fall. Due to the sophisticated shaping, the forces are absorbed, preventing any damage occurring, in most cases.

In addition to its undeniable functionality, this stainless steel crash bar features a stylish design, giving your F 850 GS the right Adventure look!

**082-5160** stainless steel

**082-5162** stainless steel black



## Touratech Suspension steering damper CSC

BMW F 850 GS / ADV | F 750 GS

Fitting the CSC steering damper makes your bike's ride and handling significantly more stable, less tiring and safer. Always supplied complete with appropriate mounting kit for the motorcycle type.

- CNC-milled from high-grade 7075 aircraft aluminium
- Optimal response characteristics for maximum safety
- Elegant Touratech design and 75 mm stroke
- Individual damping adjustment through 24 clicks
- Road legal

082-5891 F 850 GS / ADV

082-5890 F 750 GS



## Decal Set

BMW F 850 GS / ADV

Absolutely strong, thick film protects against stones and other types of damage.

Very easy to apply - strong adhesive.

100-0512 for both sides

## Touratech Suspension Cartridge Extreme

BMW F 850 GS / ADV

Putting it simply, the Touratech Suspension Cartridge Extreme is a suspension strut for the fork and the absolute top end in terms of suspension technology. The Closed Cartridge is installed into the original fork. This way the fork bridge/handlebar mount, brakes and wheel control and handlebar geometry are retained in full. No additional modifications to the fork are required. This Closed Cartridge is been developed perfectly for touring and riding with frequent and strongly differing loads and riding conditions or extreme requirements.

082-5870 F 850 GS

082-5871 F 850 GS lowering

082-5872 F 850 GS ADV



Image similar







## Height Lowering Kit

BMW F 850 GS / ADV | F 750 GS

The set includes replacement fork springs and a replacement spring for the shock absorber.

This spring set provides you with a sensible reduction in height without affecting the riding properties - at the expense of a little ground clearance. The progressive springs have been designed to match the F 850 GS perfectly, and offer a tremendous improvement in response and greater safety in extreme situations. Replacing the front and rear springs will lead to a significant improvement in your suspension system. Delivery includes detailed installation instructions, the correct fork oil and a paste to improve the slippage of the dip tubes.

### BMW F 850 GS

082-5892 Height lowering kit (2018-) -25 mm

082-5888 Height lowering kit, -40 mm

082-5887 Progressive replacement springs for fork and shock absorber

### BMW F 750 GS

082-5883 Height lowering kit, -30 mm

082-5882 Progressive replacement springs for fork and shock absorber

## Progressive fork springs

BMW F 850 GS / ADV | F 750 GS

These progressive springs have been designed to match the BMW F 850 GS perfectly, offering a tremendous improvement in response and greater safety in extreme situations than the original fork springs.

082-5885 F 850 GS

082-5880 F 750 GS

### Progressive fork springs, lowering

082-5889 F 850 GS (2018-) -25 mm

082-5886 F 850 GS -40 mm

082-5881 F 750 GS -30 mm





## Touratech Suspension

BMW F 850 GS / ADV | F 750 GS

Many advantages to other high-end brands! Touratech Suspension has been designed by TractivSuspension. Tractive has specific, profound expertise of the Touratech type of motorbike models. As an example, the people at Tractive designed most of the shocks used by BMW Motorrad since the last 10 years. They therefore understand the specific user and reliability requirements as no one else does. The shocks were developed for traction, comfort, dynamic safety, reliability and light weight. Each shock was tested driven with Touratech customers in mind. The shocks have been successfully tested on durability 4 times stricter than the original BMW standards. Detailed information on Touratech suspension and available variants can be found starting on page 596!

BMW Type:	Level2
F 850 GS	082-5862
F 850 GS (2018-)	082-5868
F 750 GS	082-5860
F 850 GS (2018-) lowering appr. -25 mm	082-5875
F 850 GS lowering appr. -40 mm	082-5864
F 750 GS lowering appr. -30 mm	082-5861



## Touratech suspension strut

Type: Plug & Travel  
for BMW ESA

BMW F 850 GS / ADV

This Touratech Suspension DDA / Plug & Travel shock absorber is an absolutely top class suspension component for your BMW F 850 GS equipped with the BMW DDC system. This premium shock absorber is systematically designed for long-distance touring with lots of luggage, on any type of road surface and even off-road. This Touratech Suspension DDA / Plug & Travel shock absorber simply replaces the BMW DDC shock. The existing plug connectors and switches on the handlebar are retained and used as usual. As a result, this shock absorber becomes an integral part of the motorcycle via the original BMW control unit. The Touratech suspension system adapts itself to the adventurer inside you, so all you have to do is ride!



082-5863 F 850 GS - ESA

082-5865 F 850 GS - ESA lowering -25 mm

082-5869 F 850 GS ADV - ESA

082-5876 F 850 GS ADV (2018-) ESA lowering -25 mm

082-5895 F 750 GS (2018-) ESA

## SKF fork seal and dust cover

BMW F 850 GS / ADV | F 750 GS

- Less friction (approx. -20%) compared to conventional sealing rings
- Self-lubricating material
- Increases long-term tightness
- Excellent water, dirt and air tightness
- UV-resistant

058-0231 F 850 GS / ADV





## Touratech Suspension shock absorber

### Type Extreme

#### BMW F 850 GS

The Touratech Suspension Extreme shock absorber ranks in the absolute premium class of suspension components. This Extreme shock absorber for the BMW F 850 GS is perfectly suited for touring and riding with frequent dramatic changes in loading and riding conditions, and the most extreme demands. The Extreme shock absorber is fitted with a position sensitive damping system (PDS), which utilises a second damping piston to provide hydraulic protection against bottoming out. Even fully loaded with luggage under the most extreme off-road conditions, the bike will not bottom out and the shock absorber is protected against mechanical overload. Damping characteristics change depending on the road surface. When riding under most conditions, the shock absorber is comfortably adjusted for a less strenuous ride, before the PDS kicks in for the last portion of the shock absorber stroke.

082-5866 F 850 GS

082-5867 F 850 GS lowering appr. -40 mm



## Tank bag Ibarra

#### BMW F 850 GS / ADV | F 750 GS

The „Ibarra“ tank bag has been specially designed for big trail bikes and large space requirements. With its foamed base plate, it sits precisely and securely on the tank. Thanks to a stable basic body made of high-quality textile fabric, the Ibarra retains its shape in all situations. The upper material is water-repellent and abrasion-resistant.

With its large main compartment, two zipped outer pockets and detachable map pocket in DIN A4 size, the Ibarra offers enough volume even on long tours. The expansion

zip allows for additional storage space. The all-round zip provides easy access. Like all Touratech tank bags, the Ibarra can also be fitted or removed in seconds with click fasteners.

Elasticated straps with quick-release fasteners, YKK brand zips and reflective sections by 3M round off these high-quality features.

Dimensions: (L x W x H) approx. 35 x 26 x 18/25 cm;

Volume: approx. 14/22 litres.

055-1281





## Tank bag AMBATO EXP / SPORT

BMW F 850 GS / ADV | F 750 GS

As we develop and offer the exclusive base plates and strong attachment kits for our robust tank bags for each specific vehicle, it is a given that a perfect fit with no play at all should be achieved! The „AMBATO EXP“ is also notable for the expansion option with an all-round zipper; small items can easily be stored under the adjustable elastic strap on the back. Thanks to the water-repellent cable hole, it's now easy to charge a mobile phone in the tank bag -plus the side pockets have an expansion pleat, which means there's even more room inside them than you would think. You'll be extremely impressed by the long list of special features.

Size: (l x w x h) approx. 37 x 27 x 22/32 cm;

Capacity: approx. 13/20 litres.



045-5800	AMBATO EXP - black
045-5825	AMBATO EXP Sport - black/white
045-5824	AMBATO EXP limited - red
045-5803	AMBATO EXP HP
045-5828	AMBATO EXP Rallye - blue
045-5829	AMBATO EXP limited - yellow

## Tank Bag AMBATO PURE

BMW F 850 GS / ADV | F 750 GS

This minimalist tank bag is a practical, well thought out piece of equipment that represents outstanding value for money. Flatter in shape and with fewer adornments, this model is suitable for all kinds of uses. For instance, it provides enough space for a day trip, can hold documents, a mobile phone, wallet and drinks on the way to a city sightseeing tour, and is also the preferred choice for off-road riding as it doesn't restrict the rider's movements while standing or affect the bike's handling.

An ideal accessory providing excellent utility value at a great price.



Size: (l x w x h) approx. 35 x 27 x 20 cm.

Volume: approx. 9 litres.

045-5802



## Tank Bag TOURING

BMW F 850 GS / ADV | F 750 GS

A timeless, classic design with proven features: That's what you get from our „Touring“ tank bag.

With its large main compartment, two zippered outer pockets and a removable map pocket (DIN A4 size), this bag has exactly what you need for both small and large tours. If you should unexpectedly need more storage space, the volume of the bag can be readily increased by opening its central surrounding zipper. The included carrying straps allow it to be also quickly and easily used as a shoulder bag or backpack. Practical, high-quality and extremely durable!



Size: (l x w x h) approx. 35 x 26 x 18/25 cm.

Capacity: approx. 14/22 litres.

045-5801



## Handlebar bag Ibarra

BMW F 850 GS / ADV | F 750 GS

A wide opening water-repellent dustproof zip provides easy access to a large main compartment in which the things you need quickly - a first aid kit, spare pair of gloves, breakdown kit or also your travel documents, wallet, sunglasses and mobile phone - are well protected. A key feature is that our bag doesn't in any way restrict the rider's movements or affect control of the bike.

045-5827



## Rain cover for the tank bags

055-1269

### Rain cover by Touratech Waterproof

055-3132 yellow

055-3133 black

## Bag to fit under luggage rack

BMW F 850 GS | F 750 GS

This small yet practical bag fits perfectly into the space under the standard luggage rack, looking made-to-measure on its own or together with the side bags.

Size: ca. 26 x 20 x 5 cm | Volume: ca. 1,5 litres

045-5842



## Handlebar bag Ibarra Smart

Practical storage space and waterproof smart-phone holder - always within reach!

The highlight of our "Ibarra Smart" is the waterproof compartment for all common smartphones (up to approx. 9x16 cm). Thanks to a small opening you can connect your charging cable.

Under the lid there is a large, weatherproof main compartment (approx. 2.4 litres) for first aid kits, high-visibility vests or sunglasses. A further, smaller compartment allows quick access to important documents and other small items. The yellow lining helps you to find the contents of the bag more easily.

A key feature is that our bag doesn't in any way restrict the rider's movements or affect control of the bike. The use of certified Cordura guarantees highest material quality.

Dimensions: (L x W x H) approx. 33/17 x 8 x 13 cm  
Volume: approx. 2.4 litres

055-1285



## Pillion Seat Bag AMBATO EXP

BMW F 850 GS / ADV | F 750 GS

The perfect solution for more luggage: AMBATO EXP! With two outer pockets, a large main compartment, the elastic drawstring on the top, the all-round zipper for when you want to increase its size and the practical carrying handle, this pillion bag can cope with any challenge! In looks, it matches the other luggage solutions in the AMBATO series, and is easily attached to the vehicle-specific base by means of two easy-opening zippers.

Comes with two carrying handles so it can be used as a backpack or shoulder bag, and with a water-repellent cable hole on the inside, tasks such as charging electrical devices is not a problem.

Size: (l x w x h) approx. 35 x 26 x 18/25 cm.

Capacity: approx. 14/22 litres.

055-1282





### **Pillion Seat Bag AMBATO PURE**

**BMW F 850 GS / ADV | F 750 GS**

This is the one that offers maximum benefit for minimum expense! If you're looking for a high-quality, sturdy and rugged pillion bag that takes up the least amount of space, doesn't get in the rider's way, is easy to mount and also offers some nice, practical features, then this is the right one for you. You can be sure that we haven't cut any

corners on our AMBATO PURE pillion bag: Despite its flatter design, this bag still offers an impressive amount of space. It's made of Cordura fabric, so it can take on the toughest demands and most extreme conditions, and its superb workmanship is legendary.

An outstanding value for the money that's very hard to resist!

**055-1283**



### **Pannier AMBATO for the Luggage Rack**

**BMW F 850 GS / ADV | F 750 GS**

Doesn't get in the way and is unbeatably useful!

There is plenty of room on the original luggage rack for a strong, practical bag. It is perfect for storing waterproofs, spare gloves, tools and small amounts of shopping safely and out of the weather. Of course, this in no way impairs the passenger's comfort, and because the bag is far back

on the vehicle, the rider is still able to get on with ease. The pannier slides onto the luggage rack from the back, is secured at the front with two straps, and the special base plate ensure that it remains safely in place. This is also a perfect ready-to-travel addition to the existing storage space!

Size: (l x w x h) approx. 24 x 29 x 17 cm.

Capacity: approx. 9 litres. Colour: black.

**045-5811**





## Stealth silencer, slip on, stainless steel black, all street legal

BMW F 850 GS / ADV | F 750 GS

- Carbon inlet and outlet cap
- Asymmetric hexagonal jacket shape
- Weight 2.84 kg
- Power and torque increase
- Super sound
- For original BMW or Remus manifold
- Including carbon heat protection
- **EURO 4 and EURO 5**

082-5850



## Fold-out luggage rack

BMW F 850 GS / ADV | F 750 GS

The first Touratech luggage rack to adapt to your needs! Folded up, it blends neatly into contours of your GS, is no hindrance during sporty, off-road excursions, but still offers enough stowage space when you're off on a day tour. It folds out in a few seconds - no need for tools - and provides a secure place for even the largest of baggage items on your F 850 GS. You can fit this luggage rack to your F 850 GS in just a few simple steps. The plate fits precisely onto the existing attachment points. This sturdily built, larger luggage rack gives you a strong and stable surface providing many ways to attach your gear.

### Features

- Precisely laser cut 4 mm aluminium and 3 mm stainless steel
- Folded up, only 42 cm wide
- Folded out, up to 60 cm wide
- Larger surface for your luggage, with slotted holes for straps
- Original pillion handles are retained
- Extremely sturdy design

**Not in combination with BMW luggage rack from „Touring Package“!**

082-5452



## Topcase Rack „Touring Package“

BMW F 850 GS / ADV | F 750 GS

The special mounting for our ZEGA Pro and Evo topcases.

Made entirely of stainless steel and extremely robust, the topcase carrier is the perfect mount for ZEGA Pro topcases. The design and function of the carrier was developed specifically for the requirements of the BMW.

In addition, the passenger hand grips are part of the carrier. And, of course, the topcase can be secured without restricting the passenger. The carrier can be used alone or in conjunction with the case system.

For combination with BMW luggage rack from „Touring Package“!

082-5457

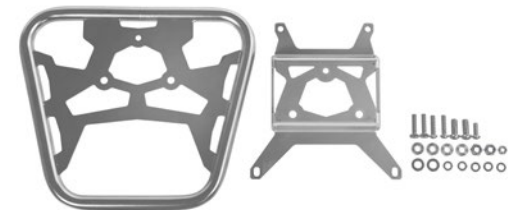

## Stainless Steel Pannier Rack

BMW F 850 GS / ADV | F 750 GS

Touratech's stainless steel pannier rack for the F 850 GS is a sturdy rack designed to take Touratech ZEGA cases. This is the perfect pannier system for extended touring. Made of 18 mm stainless steel tubing, this non-rusting system matches the appearance of the bike's frame and guarantees extra high stability even off the beaten track. Fitted as closely as possible to the vehicle frame using existing attachment points. Just a few screws is all it takes for the very strong construction to be securely attached (or removed). The angle brackets remain unobtrusive on the motorbike. The fitted width of the pannier rack is 51 cm.

082-5560 black

082-5555 silver

Matching topcases can be found starting on page 472!



## Topcase rack, stainless steel

BMW F 850 GS / ADV | F 750 GS

A special bracket construction which is attached via the 4 available screw attachment points, provides extremely high stability and loading. Your luggage is secured safely, even under the most arduous conditions! In addition, the passenger hand grips are part of the carrier.

082-5670

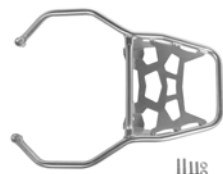

## Comfort seat Fresh Touch one piece

BMW F 850 GS / ADV | F 750 GS

This seat significantly increases seating comfort, especially on long stretches.

The reason: the ultra-bi-elastic yet strong outer material, which makes the padding even more efficient. The integrated recess relieves the pressure on the coccyx and distributes the driver's weight over the whole seat.

Thanks to the offset seams on the side and slim shape of the seat, there is no pressure against the thighs. All in all, a wonderful and comfortable seat for your BMW!

## Fresh Touch

The high quality, multi-layer seat cover is equipped with a durable Fresh Touch surface coating.

It reduces the surface temperature by significantly reflecting infrared light radiation and providing a cooler feeling when mounting a motorcycle parked in the sun. An additional, exclusive gain in comfort for your riding pleasure!

082-5912 low

082-5913 standard

082-5914 high



## Toolbox for original BMW crash bar

BMW F 850 GS / ADV | F 750 GS

This practical toolbox is bolted solidly to the mounting points of the left engine crash bar with a favourable centre of gravity, near the engine. Made of impact-resistant ABS, it has a low tare weight and large volume. The toolbox has a capacity of three liters - enough for your vehicle tools, first aid kit or puncture kit.

The large opening, which allows easy loading, is closed with a detachable lid to protect against spray water.

Suitable for the original crash bar from the BMW Motorcycle accessories range.

Suitable for combination with engine guard Expedition 082-5140

Not suitable for combination with engine guards BMW (77148404511), Touratech (082-5135/ 082-5136).

082-5610





**TOURATECH**  
**NEW**  
**PART**



### Touratech Pro BMW motorcycle toolset, 70 PCS

BMW F 850 GS / ADV | F 750 GS

Work like a pro! The unique, innovative professional toolset is especially designed for the regular service and for repairing motorcycles on the way. The compact set covers all essential applications and is therefore an ideal companion, from day trips up to world trips.

A great compact tool set that allows you to do 80% of adjustments and repair works on your motorcycle.

070-2211



050-1012



### Pannier extension VOLUME BOOSTER for original BMW aluminium pannier

BMW F 850 GS Adventure

Get the most out of your pannier and create maximum space! The VOLUME BOOSTER pannier extension increases the volume of your original BMW aluminium pannier by 12 litres!

Original BMW OEM number:

pannier right: 8 562 410 (ECE) / 8 414 630 (USA)

pannier left: 8 562 409 (ECE) / 8 414 629 (USA)

Size: (L x W x H) approx. 27 x 44 x 11 cm

Volume: approx. 12 litres

**We recommend using only one VOLUME BOOSTER per pannier! Please observe the permissible maximum payload of your vehicle! The BMW pannier is not included!**

050-1010 aluminium

050-1011 aluminium (set of 2)

050-1012 black

050-1013 black (set of 2)



### CruzTOOLS RoadTech B2 Tool Kit for BMW Motorcycles (2019-)

For modern motorcycles special tools are needed. This applies to Japanese motorcycles as well as to European motorcycles.

We've exceeded these needs with this tool kit, which packs top grade tools and other roadside items into a sturdy roll-up pouch.

070-2103

# ZEGA PRO

## ZEGA aluminium pannier system

BMW F 850 GS / ADV | F 750 GS

The aluminium pannier system again has a very robust construction. We have tried to bring the pannier racks and the panniers as close as possible to the motorcycle. Numerous tests have

# ZEGA MUNDO

already been performed in order to ensure that the entire development satisfies the required demands. The rack is made of 18 mm steel tubing and is attached to existing mounting points using special fixing clips and reinforcing pieces. Pillion comfort is not restricted in any way. Enhances the enduro and touring appearance.

Pannier System with:	stainless steel rack	stainless steel rack black
ZEGA Mundo 31/38 L	082-6130	082-6180
ZEGA Pro 31/38 L	082-5730	082-5780
ZEGA Pro AND-S 31/38 L	082-5731	082-5781
ZEGA Pro AND-Black 31/38 L	082-5732	082-5782

Pannier System with:	stainless steel rack	stainless steel rack black
ZEGA Mundo 38/45 L	082-6135	082-6185
ZEGA Pro 38/45 L	082-5735	082-5785
ZEGA Pro AND-S 38/45 L	082-5736	082-5786
ZEGA Pro AND-Black 38/45 L	082-5737	082-5787



F 850 | 750 GS

ZEGA MUNDO



ZEGA PRO



ZEGA EVO



104 cm



96 cm



More information about ZEGA cases from page **>436**



# ZEGA EVO



## ZEGA Evo special systems

A typical feature of the special system is the recess on the right-hand pannier that allows it to nestle snugly against the exhaust. The panniers are positioned closer to the bike's centreline, the overall width is reduced, and the system as a whole appears more balanced thanks to the symmetrical pannier lids. Made from stainless steel, the sturdy pannier racks are scratch and rust resistant.

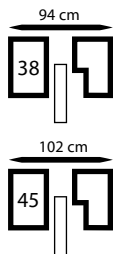

Special System with:	stainless steel rack	stainless steel rack black
ZEGA Evo AND-S 38/38 litres	<b>082-6816</b>	<b>082-6866</b>
ZEGA Evo AND-Black 38/38 litres	<b>082-6817</b>	<b>082-6867</b>
ZEGA Evo AND-S 45/45 litres	<b>082-6826</b>	<b>082-6876</b>
ZEGA Evo AND-Black 45/45 litres	<b>082-6827</b>	<b>082-6877</b>



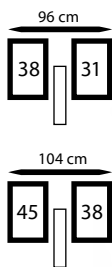

## ZEGA Evo aluminium pannier system

The ZEGA Evo, like all Touratech panniers before it, was not developed as an isolated product but was intended from the outset to be part of a luggage system. The outstanding practical benefits are the result of the unique combination of an elegant and indestructible pannier, an ingenious fastening mechanism and a terrain-immune rack made of 18 mm thick stainless steel tubes. Matching inner pannier bags and practical accessory holders round off the luggage system.

- Newly designed plastic corners - protect driver and pannier in the event of an accident
- Proven fixing pins - for ZEGA Evo accessory holder
- Proven handle - for comfortable carrying
- Newly developed fastening system - for easy mounting and secure hold on the pannier rack
- Newly developed lockable one-hand locking system - for convenient and secure attachment to the pannier rack
- Newly developed lockable lid catch- for convenient opening and closing from both sides, thanks to practical hinge function
- Proven silicone seal - for a pannier that's dry on the inside, even in the pouring rain
- Proven attachment eyes - for secure fastening of pannier lid bags and other soft luggage
- Standard hooks on the inside of the lid - for attaching accessories (bags, nets)

Pannier System with:	stainless steel rack	stainless steel rack black
ZEGA Evo AND-S 31/38 litres	<b>082-6831</b>	<b>082-6881</b>
ZEGA Evo AND-Black 31/38 litres	<b>082-6832</b>	<b>082-6882</b>

Pannier System with:	stainless steel rack	stainless steel rack black
ZEGA Evo AND-S 38/45 litres	<b>082-6836</b>	<b>082-6886</b>
ZEGA Evo AND-Black 38/45 litres	<b>082-6837</b>	<b>082-6887</b>



- 1** Handlebar | Cockpit | Windscreens | Lighting from p. 202
- 2** Seats page from p. 211
- 3** Suspension from p. 212
- 4** Engine guard | Cylinder protection | Fairing from p. 218
- 5** Tank bags | Tail rack bags from p. 222
- 6** Pannier systems from p. 225



# BMW

F 800 GS / ADV

F 700 GS

F 650 GS (Twin)



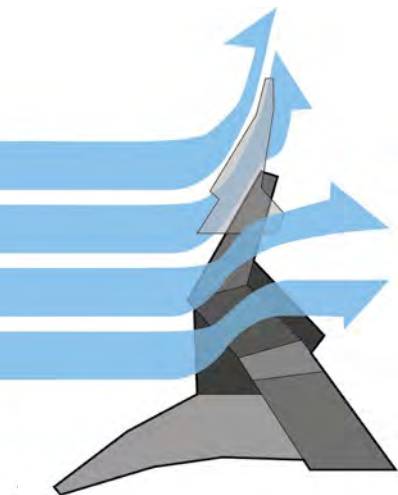

## Desierto F Fairing

### BMW F 800 GS / F 700 GS / F 650 GS (Twin)

When the stylish fairing was being developed, attention was focussed mainly on suitability for the purpose and individuality. The Desierto F's screen can not only be fitted easily but also has an infinite variety of adjustment options. Here we have managed to design an individual, modern look for the F 800 / 650 GS (Twin) combined with the highest level of everyday benefits. The main feature is that the screen can be adjusted as you like. The screen can be adjusted completely to the rider's personal requirements without any set pattern. Thus the windscreen can be adjusted highly effectively and quickly to suit any situation. Air flow and annoying

wind noise can thus be practically eliminated. The height and inclination of the screen can be adjusted as well as the distance from the fairing (important for eliminating annoying airflow).

This can be done easily in a few seconds with a standard size 10 open ended spanner. With these fittings your F 800 / 650 GS (Twin) is an absolute "eye catcher" with the highest level of driving comfort. Colour: black

### BMW F 700 GS / BMW F 800 GS (2013-)

048-1003

### F 800 GS / F 650 GS (Twin) (-2012)

048-1002

## Windscreen

### BMW F 800 GS / F 700 GS / F 650 GS (Twin)

Lots of riders of the F 800 / F 650 GS (Twin) would like a better wind protection, because the original windscreen is extremely sporty in design. We provide it with the high screen! The Touratech windscreen is much bigger, and has a different aerodynamic shape. The result improves wind protection and reduces the (wind) pressure on the rider, which results in much more relaxed riding. Turbulence around the helmet is minimised and protection against the weather improved. The windscreen is simply fitted in place of the regular one. It is attached at the same points. (To mount the windshield onto the F 700 GS the original BMW adapter 77 33 8 531 603 is required).

Height: 350 mm, width: 310 / 360 mm.

048-0370

048-0372 tinted

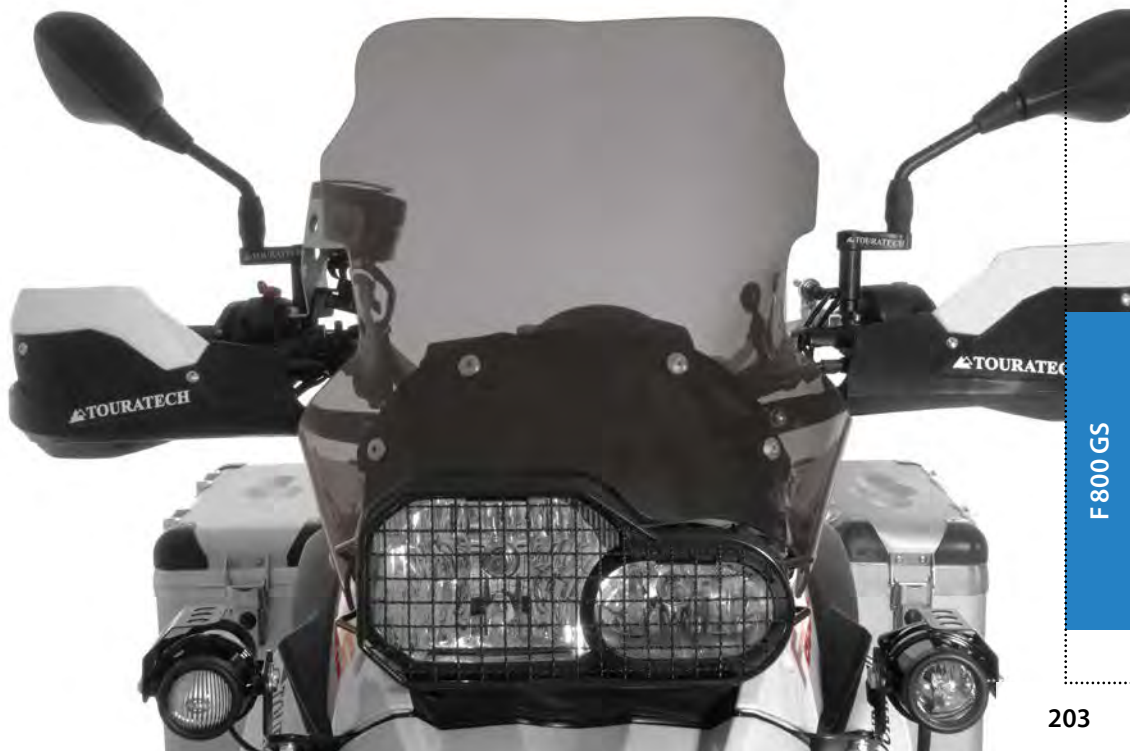



### **Windscreen spoiler Evo, with ABE BMW F 800GS / F 700GS / F 650GS (Twin)**

Whether you need it for your original windscreen or as accessory to your new Touratech windscreen – with Touratech's windscreen spoiler Evo, you gain extra comfort on each terrain. Evo offers the right balance between protection and ventilation - whether you drive on motorways, roads or off-road. Height, inclination and distance to the windscreen can easily be adjusted - you do not need any tools.

If you are going fast and the weather is rainy, fasten the spoiler at its highest level to benefit from an effective wind and weather protection. It is a noticeable relief for your head and upper body, and wind noises in your helmet are significantly reduced.

If you set the lowest level, the windscreen spoiler almost disappears. This guarantees maximum ventilation when riding off-road.

**040-1380 transparent**

**040-1381 tinted**

## Safety rear-view mirror set, aspherical, right-hand thread M10 x 1.5

BMW F 800 GS / F 700 GS / F 650 GS (Twin)

The Safety rear-view mirror is the ideal motorcycle mirror for your adventure bike. It fits any motorcycle with an M10 x 1.5 right-hand thread mirror mounting. The mirror not only looks great, it is also made of high quality and extremely sturdy plastic. Thanks to the aspherical part, the visible area is increased - making the „dead angle“ a thing of the past. The ball joint allows for easy adjustment of the rear-view mirror.

A worthwhile safety feature - for city traffic, roads and motorways! A set for both the left and the right side.

Dimensions: Total approx. (hwx) 160 x 260 mm

Glass approx. (hwx) 82 x 140 mm

040-0780



## Folding Mirror, Length Adjustable

BMW F 800 GS / F 700 GS / F 650 GS (Twin)

Universal folding mirror, length and angle continuously adjustable, to suit most motorbikes.

- Suitable for use on left or right
- Including the appropriate mounting adapter from 2013
- carries the ECE marking

040-0760

Mounting Adapter (1 unit)

040-0761 needed up to 2012



## Rear-view mirror ADV folding M10x1.5

Robust folding rear-view mirror for all motorcycles with a right-handed M10x1.5 thread

- can be set to eleven predefined positions
- can be used left or right
- with ECE certificate
- patented design

040-0770



## Crossbar

**BMW F 800 GS / F 700 GS / F 650 GS (Twin)**

For some time now, many enduro bikes have not been equipped with a crossbar. Many enduro riders will find it ideal to mount:

- Roadbook holders
- GPS receivers
- Motorcycle computers
- Map holders; and many more

**040-0603**



## Brake lever + clutch lever

**F 800 GS (-2012) / F 650 GS (Twin)**

AC-Schnitzer brake lever, adjustable

**048-5647**

AC-Schnitzer clutch lever, adjustable

**048-5648**



## Mirror Extension

**BMW F 800 GS / ADV / F 700 GS / F 650 GS (Twin)**

The mirror extension puts the mirror in a much better position. This improves the rider's field of vision. This discreet component increases safety and is almost unnoticeable. It's a must for anyone who wants to see more than just their arms in the mirrors. Parts supplied: left and right side

**040-0648**



## Kaoko Cruise Control mechanical cruise control

**BMW F 700 GS / F 800 GS (2013-) / F 800 GS ADV**

The original by the South African inventor! The Kaoko Cruise Control replaces the original handlebar end weights. The anti-slip knurled screw secures the accelerator in position. This significantly reduces the strain on the right hand during long journeys. Thanks to the continuous adjustment, the accelerator can also be fixed to decelerate very gently – leaving you enough time to take your hand off the handlebar for a moment without immediately losing throttle. Despite that, the motorbike decelerates in a gentle and controlled way. Check your national regulation.

**610-0099**



## Touratech Hand Protector GD, black

BMW F 800 GS / F 700 GS

These hand protectors are made of virtually indestructible plastic; they are modern in design, offer a high level of protection, and can easily be fitted by using the fitting sets (included). The hand protector can be combined with various spoilers and then offers optimum protection against wind and weather. A very strong, sturdy construction which has proved itself time and time again in many rallies and on other motor cycles.

- Many colours available  
(Note: Hand protectors and spoilers not available in BMW colours). Colours for hand protectors and spoilers can be combined at random.
- Vibration isolation maintained (100%)
- For use in conjunction with heated grips
- Includes special adapters

- Spoiler (colour impregnated plastic) available in black (X=1), white (X=5)
- When ordering, please substitute the X on the end of the order number for the number in brackets.

F 800 GS (-2012)

**040-668X** for aluminium handlebars

F 800 GS (2013-) | ADV

**048-566X** for aluminium handlebars

F 700 GS

**048-565X** for steel handlebars

**Spoiler for Touratech Handprotectors GD**

**040-7301 black**

## GPS Handlebar Bracket Adapter

BMW F 800 GS / ADV / F 700 GS / F 650 GS (Twin)

The bracket adapter is simply fitted to the handlebar mounting clamps on your BMW. Our GPS brackets all fit perfectly on its 12-mm brace. For easy, safe attachment of your GPS. With virtually no impairment of the view of the instruments.

**048-0210**





## Handlebar Height Increase 20 mm

BMW F 800 GS / ADV / F 700 GS / F 650 GS (Twin)

Those who like to go off-road and do so frequently, will find the 20 mm handlebar height increase indispensable. It makes it much easier to ride while standing. It also facilitates a pleasanter, more relaxed position while sitting. Significantly increases touring comfort. It takes just moments to fit the handlebar height increase. Delivery includes screws and ABE.



048-0150

## Guard for Brake Fluid Container Handlebars

BMW F 800 GS (2013-) / F 700 GS

Passers-by simply love playing with the cap on the brake fluid container. Over time, this will impair the action of the cap safety mechanism. The guard will prevent this, and protect the whole container.

Easily and quickly fitted.

048-5110 aluminium guard



## Rear brake fluid reservoir guard Stainless Steel

On the BMW the brake fluid reservoir is all too easily accessible, putting it at risk of damage or tampering. Made from laser-cut stainless steel, Touratech's brake fluid reservoir guard effectively prevents damage and undesired access to the reservoir lid, yet you can still easily see the fluid level. The guard simply bolts onto the existing mounting point.

BMW F 800 GS (-2012) / F 650 GS(Twin)

048-5031

BMW F 800 GS (2013-) & ADV / F 700 GS

048-5030



048-5031

048-5030



## Stainless steel headlight protector, black, with quick release fastener

BMW F 800 GS ADV / F 700 GS / F 650 GS(Twin)

Our headlight protector has been thoroughly tried and tested over the years - we've sold thousands. Even the biggest stones won't be able to damage your headlight with this! New durable stainless steel model now available with quick release fastener! Now you can clip on the headlight protector and detach it again as needed. Just bolt the stable and secure side struts.

And of course the protector comes with everything you need to fit it. BMW F 800 GS: for all years of construction! The headlight protector has been developed for off-road use and is not permitted in the scope of German StVO. Please check your national regulations!

048-5095



**OFFROAD  
USE ONLY**

## Headlight protector Makrolon with quick release fastener

BMW F 800 GS / ADV / F 700 GS / F 650 GS (Twin)

Makrolon pane is shatter-proof and virtually indestructible! And of course the protector comes with everything you need to fit it. BMW F 800 GS: for all years of construction! The headlight protector has been developed for off-road use and is not permitted in the scope of German StVO. Please check your national regulations!

048-5090



Photo: Christoph Isenberg





## OBD-II adapter for diagnostic tool Duonix Bikescan-100

for BMW motorbikes

For using the Duonix Bikescan-100 with the OBD-II interface on BMW motorcycles.

030-0106



## Diagnostic tool Duonix Bikescan-100 for BMW motorbikes

The Bikescan-100 is small and powerful and therefore ideal for professional control unit diagnostics on BMW motorbikes. This system covers the entire motorbike electronics and makes troubleshooting much easier for the user. Many special functions and settings can be carried out directly on the device without connecting the system to a computer or laptop. Ideal for travelling.

030-0105

## Dual USB Plug-n-Play socket

for BMW motorbikes

Let's be honest: Do you really use the DIN socket on your BMW? Simply replace it with the much more useful double USB socket! Charge your smartphone, camera, GPS, etc. without adapter while driving!

- Input voltage: 10 to 40 V
- Output voltage (USB ports): 5 V +/- 5%
- Output overvoltage, overheating and short-circuit protection
- Fully CanBus compatible
- Total 3.3 Amp output, with current limiters per port (master port 1: 2.3 A / Aux port 2: 1.0 A)
- Intelligent device recognition: detects if Apple (meets MFi standard) or Android (BC1.2).
- Weatherproof: independent port rubber covers
- Plug compatible with BMW motorcycle DIN socket installation

030-0084





## Comfort seat Fresh Touch one piece

**BMW F 800 GS / F 700 GS / F 650 GS (Twin)**

This seat significantly increases seating comfort, especially on long stretches.

The reason: the ultra-bi-elastic yet strong outer material, which makes the padding even more efficient. The integrated recess relieves the pressure on the coccyx and distributes the driver's weight over the whole seat. Thanks to the offset seams on the side and slim shape of the seat, there is no pressure against the thighs. All in all, a wonderful and comfortable seat for your BMW!



### BMW F 800 GS / F 700 GS / F 650 GS (Twin)

Fresh Touch

<b>048-5962</b>	<b>low</b>	<b>Height 50 cm</b>
<b>048-5963</b>	<b>standard</b>	<b>Height 52 cm</b>
<b>048-5964</b>	<b>high</b>	<b>Height 54 cm</b>

Dri Ride

<b>048-5916</b>	<b>standard</b>	<b>Height 52 cm</b>
<b>048-5917</b>	<b>high</b>	<b>Height 54 cm</b>

### BMW F 800 GS ADV

Fresh Touch

<b>048-5900</b>	<b>low</b>	<b>Height 52,5 cm</b>
<b>048-5901</b>	<b>standard</b>	<b>Height 55,5 cm</b>
<b>048-5902</b>	<b>high</b>	<b>Height 60 cm</b>

## Fresh Touch

The high quality, multi-layer seat cover is equipped with a durable Fresh Touch surface coating. It reduces the surface temperature by significantly reflecting infrared light radiation and providing a cooler feeling when mounting a motorcycle parked in the sun. An additional, exclusive gain in comfort for your riding pleasure!





# TOURATECH SUSPENSION

## Touratech Suspension

**BMW F 800 GS / F 700 GS / F 650 GS (Twin)**

Many advantages to other high-end brands! Touratech Suspension has been designed by TractivSuspension. Tractive has specific, profound expertise of the Touratech type of motorbike models. As an example, the people at Tractive designed most of the shocks used by BMW Motorrad since the last 10 years. They therefore understand the specific user and reliability requirements as no one else does. The shocks were developed for traction, comfort, dynamic safety, reliability and light weight. Every shock has been test driven with Touratech customers in mind. The shocks have been successfully tested on durability 4 times stricter than the original BMW standards. Detailed information on Touratech suspension and available variants can be found starting on page 596 !



BMW Typ:	Level 1	Level 2
F 800 GS ADV		048-5881
F 800 GS (2013-)		048-5883
F 800 GS (-2012)	048-5860	048-5880
F 700 GS	058-5863	058-5883
F 650 GS (twin)	048-5862	048-5882
F 800 GS   ADV (2013-) lowering appr. -50 mm		048-5884
F 800 GS (all years of construction) lowering appr. -50 mm		048-5864



## Touratech Suspension shock absorber

### Type Inline Extreme

BMW F 800 GS / ADV

The Touratech Suspension Inline Extreme shock absorber ranks in the absolute premium class of suspension components. This Extreme Shock has been developed specifically for the limited space of the BMW F 800 GS ADV. It is perfectly suited to touring and riding with frequent dramatic changes in loading and riding conditions, and the most extreme demands. Even with this compact size, our PDS is installed. A hydraulic punch of protection with full luggage prevents the penetration even at extreme slope conditions. Even fully loaded with luggage under the most extreme off-road conditions, the bike will not bottom out and the shock absorber is protected against mechanical overload. Damping characteristics change depending on the road surface. When riding under most conditions, the shock absorber is comfortably adjusted for a less strenuous ride. This means for you: Any luggage volume of the rear bag to baggage loaded system and / or pillion rider in this Extreme setting. The balance of the motorcycle can be easily and quickly adjusted by hand wheel on the hydraulic spring preload from you again. The very fine adjustable damping gives the shock every time an effective, precise and to your personal driving style adapted suspension setting for each road condition and use.

048-5871 F 800 GS (2008–2012)

048-5874 F 800 GS / ADV (–2013)



## Touratech Suspension Cartridge Kit Extreme

BMW F 800 GS / ADV

Putting it simply, the Touratech Suspension Cartridge Kit Extreme is a suspension strut for the fork and the absolute top end in terms of suspension technology. The Closed Cartridge is installed into the original fork. This way the fork bridge / handlebar mount, brakes and wheel control and handlebar geometry are retained in full. No additional modifications to the fork are required. This Closed Cartridge has been developed perfectly for touring and riding with frequently and strongly differing loads and riding conditions or extreme requirements.

048-5840 F 800 GS (2013–)

048-5846 F 800 GS ADV (2013–)

048-5866 F 800 GS (2008 – 2012)





**Touratech suspension strut**  
**Type: Plug & Travel for BMW ESA**  
**BMW F 800 GS / ADV**

The Plug & Travel strut for BMW ESA offers top performance with premium chassis technology for your BMW F 800 GS ADV with ESA system. This premium chassis is designed specifically for long-distance travel with a lot of luggage, for all road conditions through to track stages. The strut simply replaces the BMW ESA strut. The existing plugs and switches on the handlebar are used as usual. Thus the Touratech suspension strut is integrated into the motorcycle using the original BMW controls. This lets you continue using the damper settings on the handlebar and on the BMW display. The Touratech strut to suit your ADV. All you need to do is drive. Adjustment to any volume of luggage, ranging from a rear bag to a loaded luggage system and / or with a passenger, is performed easily and quickly by hand wheel via the hydraulic spring pre-tension. The unique, robust hydraulic Touratech spring pre-tension compensates for weekend tours, large luggage or your long-distance tour using the Extreme setting range. The balance of your motorcycle is set perfectly.

048-5875	F 800 GS (2013-) - ESA
048-5876	F 800 GS ADV (2014-) - ESA
048-5877	F 800 GS (2013-) - ESA lowering -50 mm
048-5878	F 800 GS ADV (2014-) - ESA lowering - 50 mm



## Height Lowering Kit

BMW F 800 GS / F 700 GS

The set includes replacement fork springs and a replacement spring for the shock absorber. This spring set provides you with a sensible reduction in height without affecting the riding properties - at the expense of a little ground clearance. The progressive springs have been designed to match the F 800 GS perfectly, and offer a tremendous improvement in response and greater safety in extreme situations. Replacing the front and rear springs will lead to a significant improvement in your suspension system. Delivery includes detailed installation instructions, the correct fork oil and a paste to improve the slippage of the dip tubes.

BMW F 800 GS (-2012)

- 048-5847 Height lowering kit, -25 mm
- 040-7402 Height lowering kit, -50 mm
- 040-7401 Progressive replacement springs for fork and shock absorber

BMW F 700 GS (2013-)

- 058-5838 Height lowering kit, -30 mm

BMW F 800 GS7ADV (2013-)

- 048-5834 Height lowering kit, -20 mm
- 048-5835 Height lowering kit, -35 mm
- 048-5832 Height lowering kit, -50 mm
- 048-5836 Progressive replacement springs without lowering

BMW F 650 GS (TWIN) (2008-2012)

- 048-5869 Height lowering kit, -30 mm
- 048-5863 Progressive replacement springs for fork and shock absorber



## Progressive fork springs

These progressive springs have been designed to match the BMW F 800 GS perfectly, offering a tremendous improvement in response and greater safety in extreme situations than the original fork springs.

Progressive fork springs for BMW F 800 GS (-2012)

**040-7400**

Progressive fork springs for BMW F 800 GS / ADV (2013-)

**048-5839**

Progressive fork springs for BMW F 700 GS (2013-)

**058-5836**

Progressive fork springs, BMW F 650 GS (Twin)

**040-7407**

## Progressive fork springs, -50 mm lowering

**BMW F 800 GS (up to 2012)**

Replacement fork springs for lowering the front end by Dutch suspension specialists Hyperpro. This spring set provides you with a practical -50 mm reduction in height without worsening the riding characteristics – at the expense of a little ground clearance. These progressive springs have been designed to match the BMW F 800 GS perfectly, offering a tremendous improvement in response and greater safety in extreme situations than the original fork springs.

**040-7411 F 800 GS (-2012)**

**040-7438 F 800 GS / ADV (2013-)**

## Progressive Replaceable Fork Springs

**BMW F 800 GS (-2012) with large tank**

Strongly recommended for use with our BMW F 800 GS tank conversion. The progressive springs are perfectly matched to the F 800 GS with our large tank and offer a significantly improved response and greater safety in extreme situations, even with the higher weight on the front wheel. Delivery includes detailed installation instructions, the correct fork oil and a paste to improve the slippage of the dip tubes.

**040-7408**



---

## SKF fork seal + dust cover

**WP43 / WP45M**

**BMW F 800 GS / ADV**

Shaft seal and dust cover by SKF:

- thus maintains optimal glide properties of the fork
- increases long-term tightness
- excellent water, dirt and air tightness. UV-resistant

**058-0220 WP43 for F 800 GS / ADV, (2013-)**

**058-0221 WP45M for F 800 GS (2008-2012)**







## AC Schnitzer Stealth rear silencer, carbon, street legal

BMW F 800 GS / ADV | F 700 GS

The latest development by AC Schnitzer. A visual highlight for the F800GS the carbon inlet and outlet covers create a sporty look; the new hexagonal design allows for greater ground clearance and more extreme lean angles, and the sporty sound ensures the appropriate appearance. Street legal, of course. Including connecting pipe!

Weight: approx. 3,1 kg

048-0951 (2017-)



## Manifold Guard, Flexible

BMW F 800 GS / ADV / F 700 GS / F 650 GS (Twin)

This heat shield is made from laser-cut stainless steel. Thanks to the special construction, it can easily be adapted to any manifold shape. Not only does it provide heat protection, but it also protects the endangered points of the exhaust system against stone-chipping or in the event of a fall. Supplied with: 2 pce., including 4 collars.

048-0132

**MADE FOR ADVENTURE.**



048-5155



048-5163



048-5160



## Stainless steel crash bar engine & crash bar extension

BMW F 800 GS / ADV / F 700 GS (2013-)

This crash bar extension from Touratech makes expensive fairing damage a thing of the past. In particular, the extension protects the upper part of the fairing while also preventing damage to the radiator and forks. The Touratech crash bar extension is made from strong stainless steel tubing with an electropolished surface finish. So if the extension is put to the test in a crash or fall, you don't need to worry about scratches turning into unsightly rust patches. Thanks to its robust design, the crash bar extension is also ideal when you need to grab hold of the bike - to pull it out of mud, for example. While striking in appearance, the Touratech crash bar extension fits in well with the overall look of the F 800 GS. In form and functionality, this extension ideally complements the BMW engine guard. Fitting the two bars onto the Touratech engine guard (048-5155) or the original BMW engine guard is simple and straightforward.

### Crash bar extension

048-5161	BMW F 700 GS / F 800 GS	stainless steel
048-5160	BMW F 700 GS / F 800 GS	stainless steel - black
048-5163	BMW F 800 GS ADV	stainless steel

### Crash bar engine

048-5155	all models	stainless steel
048-5156	all models	stainless steel - black

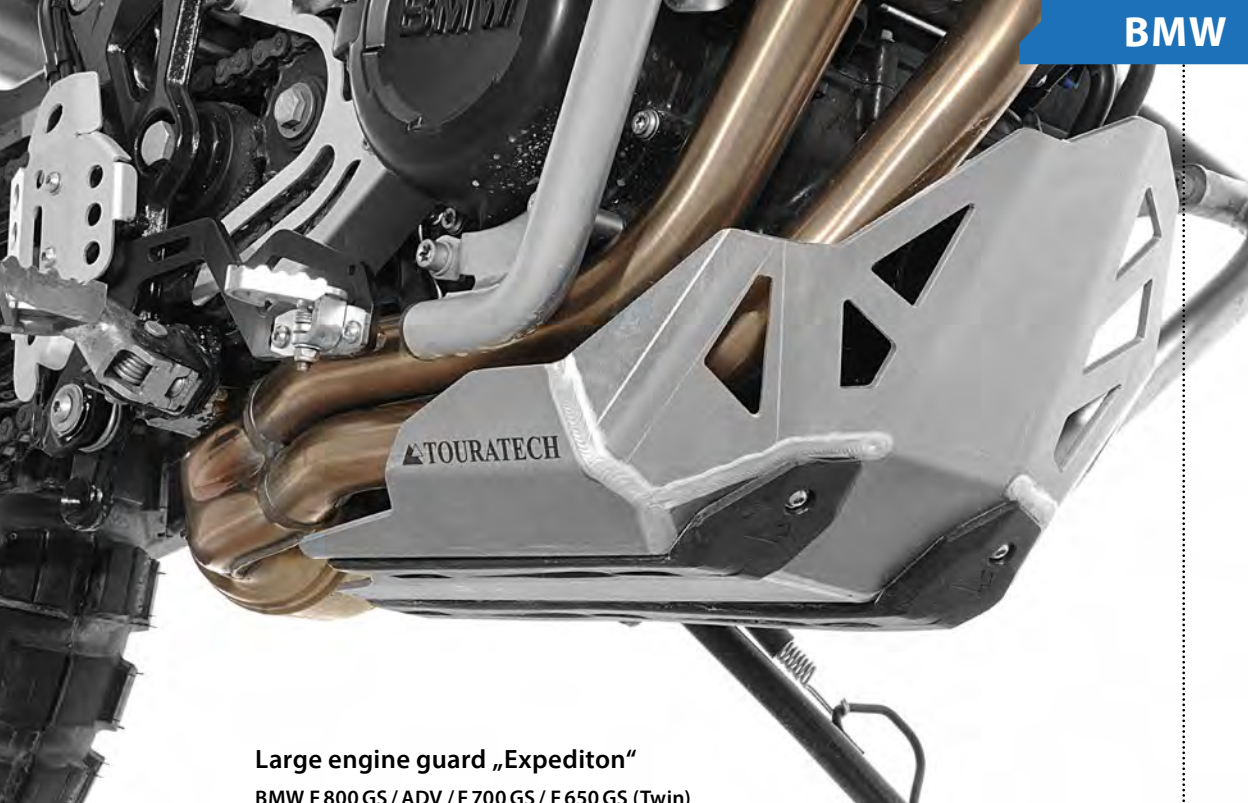

### Large engine guard „Expedition“

BMW F 800 GS / ADV / F 700 GS / F 650 GS (Twin)

In creating the F 800 GS, the developers at BMW have produced a motorbike that practically invites you take it on an off-road excursion. Our development team were able to make a number of further improvements to its positive off-road characteristics. This engine guard is an absolute revolution! Touratech have attached great importance to its robustness and functionality. Serious damage, such as holes in the engine block, can be effectively prevented by fitting the large Touratech engine guard.

Maximum strength is provided by multiple folded ridges in the 4 mm thick aluminium base plate, while an additional lower stainless steel attachment plate on the engine ensures the force of an impact is distributed over a large area via 6 bolting points. Ground clearance is not restricted by these two base plates. Another benefit is that the front of the engine guard rises up far enough to prevent damage to the oil filter and oil cooler as well. Plastic rails on the lower part of the base plate ensure that the bolt heads - which are already sunken - are completely covered. As a result, removing the engine guard is no problem even after heavy off-road use. Not least, the plastic rails facilitate „sliding“ the bike over rocks, stones and tree stumps. Almost as an afterthought, they also prevent dirt build-up. To sum up, the large Touratech engine guard for the BMW F 800 GS is a product that meets the most demanding requirements as well as being an absolute visual highlight!

048-5140

048-5141 black



## Brake Lever Extension

BMW F 800 GS / F 650 GS (Twin)

It is particularly important when riding off-road to have the brake foot safely on the brake. Our brake lever extension will make sure that your boot always finds its way to the lever and makes operation much easier and noticeably better. Material: high quality stainless steel gear lever ever be bent, it is very easy to straighten it.

048-0230



## Folding and adjustable brake lever

BMW F 800 GS / F 700 GS / F 650 GS (Twin)

Compared to the original, the Touratech brake lever's length can be adjusted by +5/-5 mm and its height by +4/+10 mm. This makes it much easier to brake while standing. And the cherry on the cake – for harder use, the brake lever also lets you attach a brake saver cable.

048-5395



## Works long-distance foot pegs

BMW F 800 GS / ADV / F 700 GS / F 650 GS (Twin)

- 52 mm wide and 4 mm thick stainless steel claw profile that is kind to your boots
- Perfect combination of grip and self-cleaning
- With a more slender design for better ground clearance
- Significantly less susceptible to impacts
- Strengthened mounting point
- With a blasted surface and laser inscription for a superior finish

048-5315

044-5316 low



## Pivot Pegz MARK 3

BMW F 800 GS / ADV F 700 GS / F 650 GS (Twin)

Thanks to a spring joint, these foot pegs follow the forward and backward movements of the foot to an angle of 20 degrees. This protects the boot, and gives the rider a better position on the bike - even in extreme situations.

040-5509

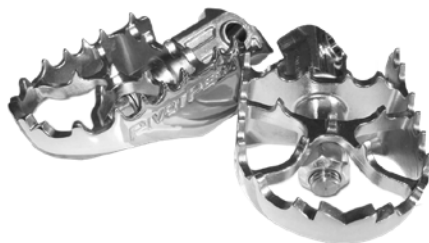

## Excel Rims with Set of Spokes

BMW F 800 GS

Over countless kilometres of testing and travelling, we have found that the weak point of many original wheels is the rims. With our rim sets you can rectify this defect without having to buy a whole new wheel! Made to the highest specifications, Excel rims have been a guarantee of the ultimate in quality for many years. Numerous world championship titles in off-road sports have been won with Excel rims made by Haan Wheels. Apart from which, the black "Made in Japan" rims also look extremely good. In our opinion, they are the best looking wheels on the market by far! The Touratech Racing Team relies exclusively on Excels!

Scope of delivery:

- Excel rim \*black\*
- Stainless steel spokes (36 pieces)

(Hub, rear sprocket and brake discs are not included in scope of delivery)

For the front wheel 53,34 x 5,46 cm (21" x 2,15") / 36

048-0500





## Kick Stand Support Extension

BMW F 800 GS / F 700 GS

Made of high quality stainless steel

BMW F 800 GS (2013-) / ADV

Does not fit, if a lowering kit is mounted!

048-5275

BMW F 700 GS (2013-)

048-5276



048-5275



048-5276



## Tank Bag „BLACK EDITION“ water repellent

BMW F 800 GS / ADV / F 700 GS / F 650 GS (Twin)

Its basic volume of approx. 12 litres quickly and easily expands to approx. 20 litres via an all-round zip. Plus two side pockets provide space for your wallet or papers. A reflective elastic strap on the back is handy for holding your gloves during a short stop, for example. Water-repellent zips are used on the main compartment and both side pockets. The map pocket (26 x 28 cm) securely attaches to the tank bag using Velcro. Inside the top cover there is a document compartment with separate credit card pouch and elastic loops

to hold small items like a biro. Two clip-buckles at the front and the Velcro fastener at the back ensure the tank bag can be quickly attached to your bike and is held securely. For off-road use and when fully loaded, the tank bag can also be secured using two side straps. A sturdy handle and two rucksack straps (supplied) round out this fully equipped bag. Colours: black, grey, yellow. Made from Teflon-coated CORDURA which is both water-repellent and dirt-resistant.

Size (l x w x h): approx. 30 x 33 x 18 / 26 cm

Capacity: approx. 12 / 20 litres

048-5803

## Handlebar bag „Ibarra“

BMW F 800 GS / F 800 GS ADV / F 700 GS / F 650 GS (Twin)

Practical storage space exactly where you need it! The sturdy handlebar provides enough space to attach an extremely practical and travel-worthy bag. A wide opening water-repellent dustproof zip provides easy access to a large main compartment in which the things you need quickly - a first aid kit, spare pair of gloves, breakdown kit or also your travel documents, wallet, sunglasses and mobile phone - are well protected. A key feature is that our bag doesn't in any way restrict the rider's movements or affect control of the bike!

045-5827



## Tail Rack Bag „Ambato“ for luggage racks

The practical and extendable rear bag is easy to mount on all Touratech luggage bridges using the three supplied straps and offers plenty of room for all those smaller items, for example, the rain suit or extra gloves. And, of course, it fits virtually all of the original luggage bridges of most vehicles, it only requires a basic area of 27 x 17 cm!

Size: (L x W x H) approx. 17 x 27 x 12/20 cm  
Volume: approx. 4/8 litres. Colour: black

055-1298





## Pannier Rack

BMW F 800 GS / F 700 GS / F 650 GS (Twin)

Strong pannier rack, 18 mm tube diameter. Notable for the carrying handles. They provide support for the pillion passenger and are useful if you ever have to pull the motorbike out of the mud! Pannier rack easy to fit to existing attachment points with the special brackets. Ideal for the long-distance look of the F 800 GS and F 650 GS (Twin)!

051-2230 black rack

048-5555 stainless steel



## ZEGA Pro / Evo Topcase Rack

BMW F 800 GS / ADV / F 700 GS / F 650 GS (Twin)

The Special Carrier for our ZEGA Pro and Evo Topcases. Made entirely of stainless steel and specifically designed for the BMW's attachment points, the topcase rack is the perfect way to attach ZEGA Pro and Evo topcases to your bike. The topcase rack can be used on its own or in conjunction with our pannier system.

048-0183 silver



## Luggage Rack Aluminium

BMW F 800 GS / ADV / F 700 GS / 650 GS (Twin)

Thanks to all the slits and recesses on the luggage rack aluminium, luggage of almost any shape and size can be safely attached to your bike. The wide shape allows large items to be secured easily and without difficulty. The luggage rack aluminium is light and yet extremely strong. It comes with all of the attachment materials that are required, including the special spacers.

048-5450 black

048-0101



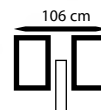

## ZEGA Aluminium Pannier System

BMW F 800GS / F 700GS / F 650 GS (Twin)

The aluminium pannier system again has a very robust construction. We have tried to bring the pannier racks and the panniers as close as possible to the motorcycle.

Numerous tests have already been performed in order to ensure that the entire development satisfies the required demands. The rack is made of 18 mm steel tubing and is attached to existing mounting points. Pillion comfort not restricted in any way. Enhances the enduro and touring appearance of the F 800GS / 650GS(Twin).

Pannier System with	stainless steel rack	black rack
ZEGA Mundo 31 / 38 L	048-6130	048-6180
ZEGA Pro 31 / 38 L	048-5730	052-3101
ZEGA Pro AND-S 31 / 38 L	048-5731	052-3102
ZEGA Pro AND-Black 31 / 38 L	048-5732	052-3103



More information about ZEGA cases from page **>436**

## INSIGHTS INTO THE TOURATECH PRODUCTION

# MADE IN GERMANY

Touratech is at home all over the world, but the accessory manufacturer's products are made in Germany. This ensures compliance with the highest standards of quality and social responsibility.



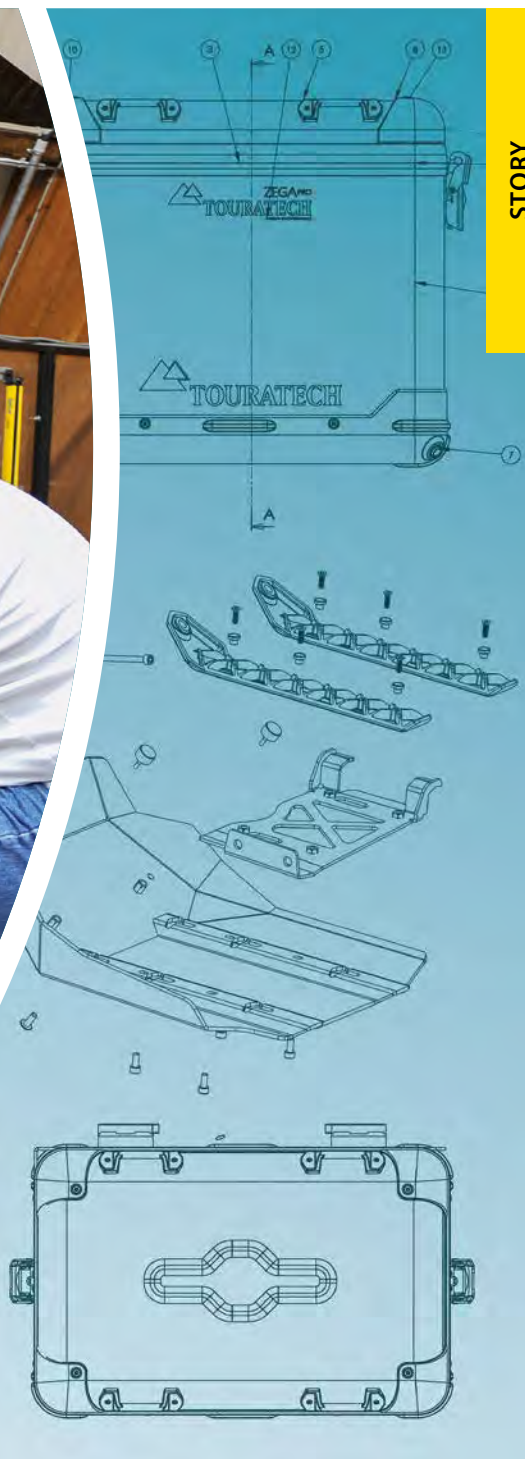

STORY

**At Touratech they think globally. This is hardly surprising, as the roots of the Niedereschach-based company** are inextricably linked with countless motorcycle expeditions and sporting events at international rallies. Globetrotters from all over the world use Touratech motorcycle accessories and rider equipment and contribute to the continuous improvement of the products with their qualified feedback. And last but not least, there is the global family of Touratech distributors. Around the globe, motorcycle enthusiasts have made it their mission to make Touratech products available in their markets with a unique blend of lived Traveller spirit and professionalism. However, the Touratech bases in Germany, Europe and worldwide are much more than retail outlets. They form important hubs within a network of contact points where motorcycle travellers are helped with advice and support.

In terms of manufacturing, however, Touratech remains down-to-earth. The high-quality products are all manufactured in Germany, a large part even at the headquarters in Niedereschach.

## **Manufacturing at the headquarters**

Parallel to the construction of the new administrative headquarters and logistics centre, Touratech has also comprehensively modernised and expanded its production. However, this biggest restructuring in the company's history was not only about quantity. Touratech has also forged ahead into new dimensions on the technical level, „Our new machines are among the best and fastest on the market,“ explains Touratech COO, Jochen Schanz, whose responsibilities include production. „We have re-equipped our entire laser and bending department with state-of-the-art machine tools. This gives Touratech a fully

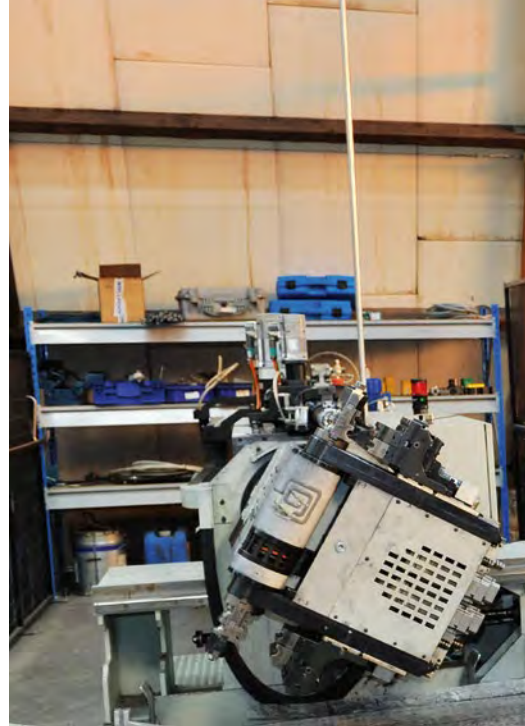



*The mandrel bending machine gives tubes for crash bars, pannier racks and many other products their shape (above). In the punch-laser combination, stainless steel and aluminium blanks - such as those needed for panniers, headlight protectors or engine guards - are produced (left). The fully automated sheet metal storage system (right).*

automated sheet metal storage system with three automatic laser and punch-laser combination machines.“ The investment of around four million euro in the machinery is of course not an end in itself.„The new machines make it possible to produce parts that are much more complex, which gives our development department additional freedom when it comes to product design,“ says Schanz. „This means our customers receive parts whose functionality is even more specifically tailored to their respective requirements. The higher capacities also allow us to offer products for even more types of motorcycle. And finally, we were able to reduce the quota of purchased components significantly.“

However, setting up the new machines alone is not the end of the matter. A complex production planning and control system (PPS) is required to run a modern production facility economically. With the aim of maximum adherence to schedules, all production orders are reallocated to the available capacities (employees and machines) every night. A separate department, known as Lean and Production Logistics, ensures that material is not stored or transported unnecessarily, but instead is processed immediately.

However, the modernisation of production does not mean that the human factor will play a subordinate role in the future. Quite the opposite. At present, around 200 employees work in the four production areas of sheet and tube, welding and surface, assembly and packaging, and production logistics.„In the future, we will have a strong need for skilled workers, and new managerial positions will also be created in our production department,“ says the manager, describing the foreseeable development.

An important component of the new structure is the enhancement of quality assurance.

Further revolutionary changes are already on the



## How the ZEGA EVO is made

**1** *Cutting the sheet metal parts with the laser*



Drying tower for setting the silicone compound (below). Flatbed laser used to cut aluminium and stainless steel (right).

The bending robot is loaded with blanks (right, above).



**2** Bending the outer shell in the production cell



**3** Automated bending of base and lid (in this case a BMW pannier)



horizon. Keyword Industry 4.0. „In the future, the transparency of production processes will become even more important,” Schanz sketches the scenario. „Machines will communicate with each other, stock levels will be automatically reconciled with the inventory management system; machines will be able to provide real-time information on the current processing status of an order; and barcodes will have a machine-readable record of the entire history of each product.“

## OEM – manufacturing for strong partners

Around 30 percent of production capacity is planned for the manufacture of what are called OEM parts. The abbreviation OEM stands for Original Equipment Manufacturer. In the case of Touratech, these are products that are produced on behalf of motorcycle manufacturers for their in-house range of accessories.

OEM customers include the most renowned vehicle manufacturers. Ducati also purchases products from Touratech that are sold under Ducati’s own brand through its in-house accessories programme, as do BMW and KTM. Indeed, Touratech has a particularly long partnership with the Austrian motorcycle manufacturer. The legendary KTM 620 Adventure, which shook up the adventure bike segment at the end of the 1990s, could even be ordered with aluminium panniers from Touratech. The basis was the legendary ZEGA pannier, the ancestor of all Touratech panniers today.

For Touratech, „OEM production is not only an important means of balancing out the highly seasonal end customer business through basic capacity utilisation. The extremely high demands that motorcycle manufacturers place on their suppliers force

**4** Riveting eyelets onto the lid of the ZEGA Evo



**7** Application of the silicone seam with the dosing device



**10** The finished ZEGA Evo panniers...





**5** Automatic dosing of adhesive



**6** The base of the ZEGA Evo is sealed with a silicone sealing tape



**8** Drying tower with precisely determined temperature and humidity values

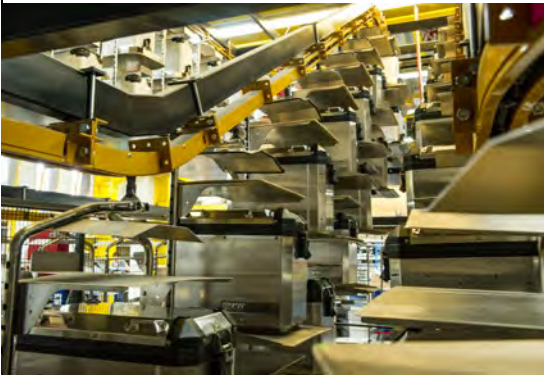

**9** Fitting the mounting system



**11** ...are packed for shipment



**12** Satisfied: Jochen Schanz and Michael Gnädig with a randomly selected pannier



us to be at the cutting edge of technology all the time - which of course is also reflected in the quality of the products we sell under the Touratech brand ourselves," says Jochen Schanz, explaining the connections.

## **Into the future at full throttle: plastics and hydroforming**

The great innovative spirit of the developers and the absolute demand for quality require the use of the latest technologies in production. An important complement to metal processing is plastic injection moulding. Over the past decades, Touratech has also built up the highest level of expertise in this area. This is because high-quality plastics are playing an increasingly important role in the quality products from Niedereschach.

With some parts such as the popular Desierto fairings being made entirely of plastic, this is obvious. A critical second look is needed to reveal the countless areas of application for the most diverse plastics across the entire range. The shells for the comfort seats are an example, and also the heavy-duty seat foams, the protective corners of the Zega Pro panniers, parts of smartphone and GPS supports and many other components are made of this versatile material.

And in the future, there will be further areas in which plastic will help to make Touratech products even better. One development aspect now being focused on is plastic hybrid parts, i.e. the combination of plastic and metal - already used for the side covers of BMW boxers.

While classic welded constructions made of folded sheet metal have characterised the appearance of numerous Touratech products for more than two decades, rounded shapes have come to the fore in the recent past. This was made possible by the intro-





Inserting a „blank“ into the hydroforming unit (above) Injection moulding plant for the production of seat shells (far left)

The formulations for the seat foams vary depending on the model (left)

duction of a new technology, more precisely the still relatively new forming process called hydroforming. Put simply, this forming method uses extremely high water pressure to press a sheet of metal against the wall of a mould, replicating its morphology exactly. Unlike deep drawing, hydroforming only requires one tool. And in contrast to the well-known tube hydroforming, in which two welded sheet metal parts are expanded by water pressure from the inside to form a hollow body (two-stroke exhaust pipes are a well-known application), the sheet hydroforming used by Touratech can be used to realise extremely complex shapes with maximum repeatability.

Of course, the shape of a product is first and foremost a design element, but for Touratech it is crucial that the products become even more functional through the possibilities of the new process.

The engine guards of the „Rally“ series are a good example of the increase in functionality. While classic designs, with folded and welded aluminium elements, are such that the manifolds have to remain on the outside, the comprehensive design of the new one-piece engine guard incorporates them. This results in a significant plus in protection for the vehicle because manifolds, particularly when hot, are sensitive to stone impact.

Also in the future, motorcycle travellers from all over the world can count on being able to use the most innovative products from Touratech - Made in Germany, of course. ◀





*The 3D laser can process complicated, three-dimensional components (above)  
The three-dimensional data for the component is then generated in a CAD program (left)  
The 3D laser cuts the pannier lid from the deep-drawn blank. The remaining piece is recycled (below)*





NEW IDEAS FOR MOTORBIKES

**TOURATECH**



- 1** Handlebar | Cockpit | Windscreens | Lighting from p. 240
- 2** Engine guard | Cylinder protection | Fairing from p. 248
- 3** Suspension from p. 258
- 4** Foot pegs from p. 257
- 5** Tank bags from p. 262
- 6** Tail rack bags from p. 264
- 7** Pannier systems from p. 266

# HONDA

CRF 1100 L  
AFRICA TWIN

CRF 1100 L  
ADVENTURE  
SPORTS





## Spoiler for windscreen, lockable

CRF 1100 L Africa Twin | CRF 1100 L ADV Sports

This special spoiler for the windscreen is perfect for undertaking long, fast motorbike journeys in comfort. There is a significant reduction in turbulence and wind pressure against the helmet.

It simply fits onto the windscreen, and is secured using the snap closure. When going off-road, the spoiler is easy to remove in seconds.

046-0647



## Windscreen spoiler Evo, with ABE

CRF 1100 L Africa Twin / Adventure Sports

Whether you need it for your original windscreen or as accessory to your new Touratech windscreen - with Touratech's windscreen spoiler Evo, you absolutely gain extra comfort on each terrain.

Evo offers the right balance between protection and ventilation - whether you drive on motorways, roads or off-road. Height, inclination and distance to the windscreen can easily be adjusted - you do not need any tools.

If you are going fast and the weather is rainy, fasten the spoiler at its highest level to benefit from an effective wind and weather protection. It is a noticeable relief for your head and upper body, and wind noises in your helmet are significantly reduced.

If you set the lowest level, the windscreen spoiler almost disappears. This guarantees maximum ventilation when riding off-road.

040-1380 transparent

040-1381 tinted



## Windscreen transparent/tinted Honda

### CRF 1100L Africa Twin / Adventure Sports

Not satisfied with the original wind shield of your bike? Thanks to countless miles of adventure experience and to the know-how of our production department, we developed a wind shield that unites an appealing adventure design and an optimal function for every application.

Replace your original windscreen with the Touratech wind shield and discover much better driving properties! The form and function of the upper edge of the wind shield is based on our rally experience. The aerodynamic optimization guides the air streams over the head of the pilot without unnecessary turbulences. So, the wind shield is not only flatter-free, it also guarantees a relaxed driving pleasure that doesn't exhaust the pilot nor the pillion passenger.

The Touratech wind shield gives your bike an individual design that will fascinate you. Of course, we tested the wind shield thoroughly for your machine. Thus you get a wind shield that improves your bike both technically and visually.

- Especially developed for your bike
- Aerodynamically optimised form
- Flatter-free even at high speeds
- Minimized air turbulences
- Non-exhausting driving
- Cool adventure design

Available in different heights and shades.

#### CRF 1100L Africa Twin

403-6200	S	transparent
403-6202	S	tinted
403-6210	M	transparent
403-6212	M	tinted
403-6220	L	transparent
403-6222	L	tinted

#### CRF 1100L Adventure Sports

403-6230	S	transparent
403-6232	S	tinted
403-6240	M	transparent
403-6242	M	tinted
403-6250	L	transparent
403-6252	L	tinted

403-6242



403-6200



403-6212





## Handlebar Riser 20 mm, type 50

CRF 1100 L Africa Twin / CRF 1100 L Adventure Sports

It's often the little things that make all the difference! As is the case with the Touratech handlebar riser for the Africa Twin. Raising the handlebar by 20 mm results in a more upright, much more relaxed seating position. The adjustment range of the handlebar angle is increased, which further increases rider comfort. The Touratech handlebar riser also makes riding while standing less tiring, which is of tremendous benefit to taller riders in particular.

The overall result is a noticeable increase in stamina and concentration. Long stretches on the motorway are less nerve-racking, and even fast, difficult sections off-road are easier to handle.

Easy to fit in minutes. No need for long cables or brake cables!

Material: aluminium.

403-5255 silver anodised



## GPS Handlebar Bracket Adapter GPS Bracket Adapter / Bracket for Navigation Systems

CRF 1100 L Africa Twin / CRF 1100 L Adventure Sports

The bracket adapter is simply fitted to the handlebar mounting clamps on your Africa Twin. Our GPS brackets all fit perfectly on its 12-mm brace. For easy, safe attachment of your GPS. With no impairment of the view of the instruments.

402-5410



## GPS handlebar bracket above the instruments

CRF 1100 L Adventure Sports

Successful rallye racers show us how it's done: they fit their instruments in the central field of vision. And what works for rallyes is also a perfect solution for everyday use! Our „mounting adapter above instruments“ lets you keep your GPS device or road book firmly in view. No more looking down or distractions to the side - your eyes are always pointed at the road.

403-5415





## Headlight Protector with Quick Release Fastener

CRF 1100 L Africa Twin /  
CRF 1100 L Adventure Sports

Our headlight protector has been thoroughly tried and tested over the years – we've sold thousands.

Even the biggest stones won't be able to damage your headlight with this!

New model now available with quick release fastener! Now you can clip on the headlight protector and detach it again as needed. Just bolt the sturdy and secure side struts. And of course the protector comes with everything you need to fit it.

The headlight protector has been developed for off-road use and is not permitted in the scope of German StVO. Please check your national regulations!

403-5090 Makrolon ATAS

403-5095 Aluminum ATAS

403-5096 Aluminum AT



**OFFROAD  
USE ONLY**

## Safety rear-view mirror set, aspherical, right-hand thread

CRF 1100 L Africa Twin / CRF 1100 L Adventure Sports

The Safety rear-view mirror is the ideal motorcycle mirror for your Adventure Bike. It fits any motorcycle with an M10 x 1.25 right-hand thread mirror mounting. The mirror not only looks great, it is also made of high quality and extremely sturdy plastic. Thanks to the aspherical part, the visible area is increased - making the „dead angle“ a thing of the past. The ball joint allows for easy adjustment of the rear-view mirror. A worthwhile safety feature - for city traffic, roads and motorways! A set for both the left and the right side.

Dimensions: Total approx. (h x w) 160 x 260 mm  
Glass approx. (h x w) 82 x 140 mm

040-0785



(E)

403-5640

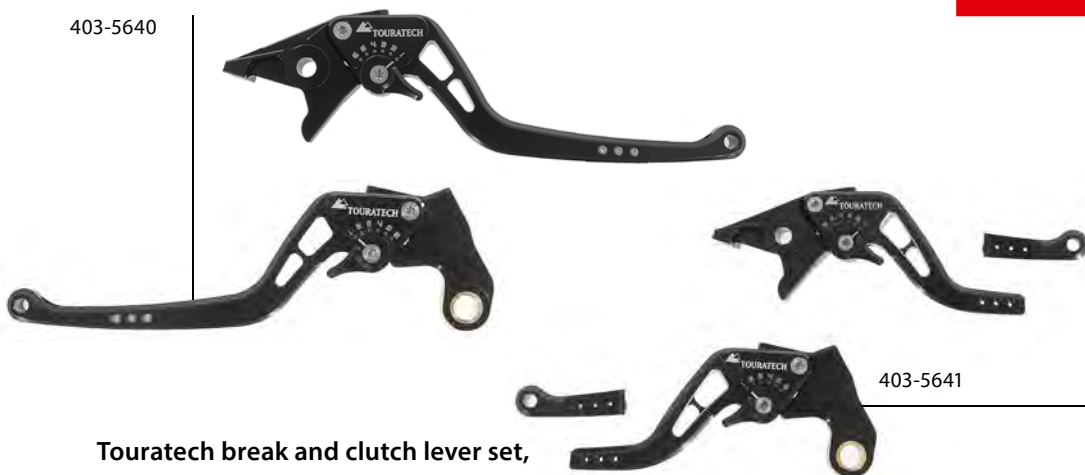

403-5641

### Touratech break and clutch lever set, adjustable

CRF 1100L Africa Twin /  
CRF 1100L Adventure Sports

The Touratech levers are milled from high-strength aluminum as in aircraft construction from the full. They are 6-way adjustable and hinged. In case of a fall the lever can fold up without breaking it. In normal operation, the levers are protected by a fold-up mechanism.

The levers are adjustable in length by dovetail connection by 35 mm. The anodization meets the highest quality standards. All screw connec-

tions comply with the DIN standard and are tightened before delivery with the torque wrench. The CNC levers are delivered with German ABE (General Operating Permit) and are therefore registration free.

#### Break and clutch lever set, adjustable

403-5640

#### Break and clutch lever set, short

403-5641

### Rear-view mirror Adventure folding M10x1.25

CRF 1100L Africa Twin /  
CRF 1100L Adventure Sports

Robust folding rear-view mirror for all motorcycles with a right-handed M10x1.25 thread. Two different basic positions and an adjustment range of 180 degrees with eleven different locking positions cover all eventualities for adjusting the mirror. The rear-view mirror can be folded during off-road travel and during transport to avoid any damage. In addition, the swivel arm folds in case the motorcycle falls over.

- can be used left or right

Length 26 cm

Scope of delivery: 1 mirror with instructions for installation and adjustment

040-0771





## Set of LED auxiliary headlights fog/fog

### CRF 1100 L Adventure Sports

Enjoy all the benefits of modern LED technology on your motorbike! Kill several birds with one stone with the Touratech LED auxiliary headlights:

#### Greater active safety:

- better illumination of the field of vision with a much clearer light/dark boundary
- lowest possible scatter of the light beam in height with fan-shaped illumination in the width
- improved contrasts thanks to the white, daylight-like LED light

#### Greater passive safety:

- low power consumption, i.e. the auxiliary headlights can even be used permanently with weak alternators or lots of consumers
- no need for replacement lights thanks to the extremely long-lasting, maintenance-free LED elements

All this combined with a Touratech attachment that is specially tailored to the Adventure Sports!

We use innovative LED headlights of 70 mm diameter

for our auxiliary headlights. The excellent light output is made possible by the latest lighting technology and high-performance LEDs with a higher level of efficiency. Power consumption: just 13 watts per headlight! (Halogen: ~55 watts).

The LED technology offers additional benefits: the headlights are very light. And thanks to the special aluminium housing and the lens made of reinforced laminate, they are also highly stable! They have a very low construction depth of just 55mm, which makes them much easier to attach without harming the design. More light and innovative technology means more safety, while the bike looks better thanks to the „Adventure design“ - and everything is in the customary Touratech quality. All you have to do is ride! ECE and SAE-approved, so no need to change your records! What's included:

- 2 LED „Fog“ auxiliary headlights with control units
- vehicle-specific attachment for headlights and control units
- cable assembly
- assembly instructions

403-5471



## Hand protectors

CRF 1100 L Africa Twin /  
CRF 1100 L Adventure Sports

These hand protectors are made of virtually indestructible plastic; they are modern in design, offer a high level of protection, and can easily be fitted to the Honda using the fitting sets (included). The hand protector can be combined with various spoilers and then offers optimum protection against wind and weather.

A very strong, sturdy construction which has proved itself time and time again in many rallies and on other motor cycles.

Also suitable for DCT.

402-5650 black

402-5654 white

## Spoiler for hand protectors

CRF 1100 L Africa Twin /  
CRF 1100 L Adventure Sports

040-7301 black





Defensa EXTENSION  
(SPOILER)

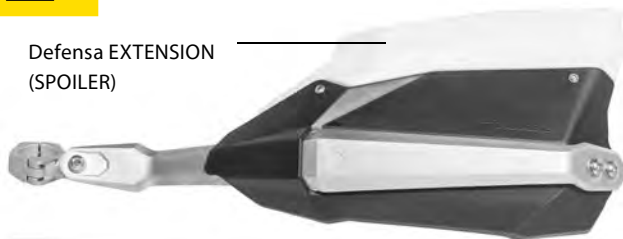

Defensa EXPEDITION  
+ EXTENSION



Defensa PURE  
403-5650

## Hand protectors DEFENSA

CRF 1100L Africa Twin / CRF 1100L Adventure Sports / DCT

Whether off-road riding or touring – the Touratech Defensa offers reliable protection for handlebar fittings and hands, so that a minor mishap does not turn into a major problem. With the Defensa, Touratech has developed an extra-robust protector for handlebar fittings and hands. The construction made of high-strength aircraft aluminium is precisely adapted to your motorbike model. Thanks to the „Defensa System“, the protector offers interesting variation possibilities. Whether you choose a pure protector or a wide protector with an extra spoiler... Defensa hand protectors – for a particularly wide range of uses.

### Defensa Pure

403-5650	silver
403-5660	black

### Defensa Expedition

403-5651	silver / black
403-5652	silver / white
403-5661	black / black
403-5662	black / white

### Defensa Extension

102-5651	black
102-5652	white

## DEFENSA Leverguard (Set)

CRF 1100L Africa Twin / CRF 1100L Adventure Sports / DCT

For all motorbike purists, but thoughtful of their machine, the Defensa Leverguard will provide the right level of protection for the front brake and clutch levers.

To prevent you braking one or the other levers, Touratech proposes a simple, useful and aesthetic solution: the Defensa Leverguard. They do not only protect your levers in case of a crash, but they furthermore protect the levers from being hit by e.g. tree branches or car mirrors.

Made of high-strength drop forged aircraft aluminum and finished with a plastic nozzle as a matter of design, they are lightweight and stylish.

It can be adapted to become another variant of our Defensa portfolio: Pure or Expedition.

403-5655

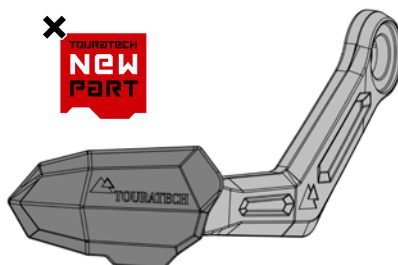



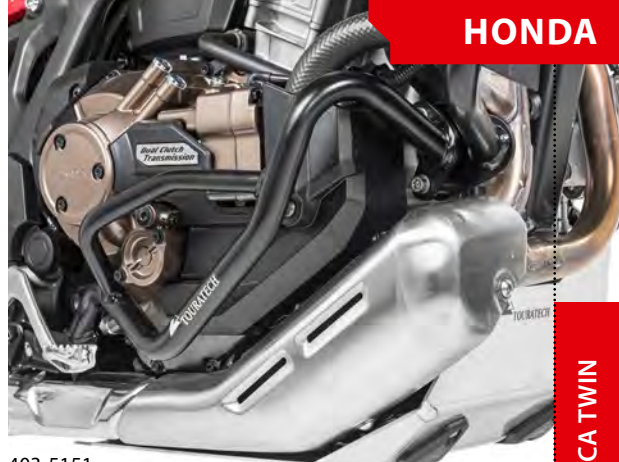

403-5151

## Toolbox with engine crash bar retrofit kit - left side

### CRF 1100 L Africa Twin / CRF 1100 L Adventure Sports

The practical toolbox is solidly bolted to the specially developed crash bar near the engine, keeping the centre of gravity low. Made of impact-resistant ABS, it has a low weight and a large volume. Its capacity is approx. 3.5 litres – enough for the on-board tools, the first aid kit or the puncture kit. The large opening, which allows easy loading, is closed with a removable splash-proof lid.

You have not yet installed a Touratech crash bar? No problem, order the box with the complete crash bar (DCT: 403-5165/403-5167; No DCT: 403-5166/403-5168).

Scope of delivery:

- Tool box
- Left-hand engine crash bar with box mount
- Mounting material

403-5154 stainless steel

403-5159 stainless steel black

Even more variants in the webshop!



## Stainless Steel Engine Crash Bar

### CRF 1100 L Africa Twin / CRF 1100 L Adventure Sports

Touratech's engine crash bar provides optimum protection for the engine's important side panels.

Its slender design does not affect the lean angle at all and means you can ride on difficult single trails off-road as well as on-road. Made from resilient stainless steel, the engine crash bar gleams thanks to its high quality electropolished/black finish. It perfectly complements the sporty, aggressive lines of the HONDA CRF 1100 L. Together with the Touratech fairing crash bar for your Africa Twin, you don't need to fear a fall again!

403-5150 DCT stainless steel

403-5151 DCT stainless steel black

403-5152 stainless steel

403-5153 stainless steel black



403-5152



403-5162



403-5160

### Fairing crash bar stainless steel

CRF 1100L Africa Twin /  
CRF 1100L Adventure Sports

The crash bar is made of high quality, electropolished stainless steel and extends the range of use of your travel enduro. The two-component crash bar was fitted as close as possible to the vehicle to give harmonious integration into the existing vehicle design. Its special design provides optimal force dissipation and largely protects the radiator as well as the tank and fairing against damage. The crash bar is simple to install, rust-proof and easy to care for.

#### Stainless steel

403-5160 Adventure Sports

403-5162 Africa Twin

#### Stainless steel black

403-5163 Africa Twin

403-5161 Adventure Sports



403-5161



## Engine Guard EXPEDITION

### CRF 1100L Africa Twin

In creating the Honda CRF 1100L, the developers at Honda have produced a motorbike that practically invites you to take it on an off-road excursion. Our development team was able to make a number of further improvements to its positive off-road characteristics. This engine guard is an absolute revolution!

Touratech has attached great importance to its robustness and functionality. Serious damage, such as holes in the engine block, can be effectively prevented by fitting the large Touratech engine guard. Maximum strength is provided by multiple folded ridges in the 4 mm thick aluminium base plate, while an additional lower stainless steel attachment plate on the engine ensures the force of an impact

is distributed over a large area via 6 bolting points. Ground clearance is not restricted by these two base plates. Another benefit is that the front of the engine guard rises up far enough to prevent damage to the oil filter and oil cooler as well. Plastic rails on the lower part of the base plate ensure that the bolt heads - which are already sunken - are completely covered. Not least, the plastic rails facilitate "sliding" the bike over rocks, stones and tree stumps. Almost as an afterthought, they also prevent dirt build-up. To sum up, the large Touratech engine guard for the Honda CRF 1100L is a product that meets the most demanding requirements as well as being an absolute visual highlight!

403-5140





## Engine guard extension

CRF 1100 L Africa Twin /  
CRF 1100 L Adventure Sports

We have developed an engine guard extension to go with our engine guard. The design is the same, technically and optically. The extension closes the gap between the engine guard and the rear wheel. An unbeatable advantage, especially off-road! Nothing can get stuck or caught around the main stand.

The engine guard extension also protects parts of the exhaust from stones and other kinds of dirt that get thrown up. Also really useful in road use! The angles of the 3 mm thick aluminium sheet provide maximum stability. There is no restriction of ground clearance. The engine guard extension attaches to the main stand in moments.

403-5145



## Radiator protector black

### CRF 1100 L Africa Twin

The Touratech radiator protector shields the vulnerable lamellae of the radiator against damage and thus provides an enormous safety benefit! The dread of flying stones, sticks or other debris will be no more. A small investment will make your trip a whole lot safer! Optically unobtrusive yet in the unmistakable Touratech-style, the radiator protector made of laser cut aluminium blends in with the Honda design perfectly.

Colour: black

Parts supplied: 2 parts (left and right)

Note: The radiator cover can cause the engine to overheat under extreme conditions with high outside temperatures and an extreme engine load. Please watch your water temperature gauge.

403-5015



CRF 1100 L AFRICA TWIN

## Brake calliper guard front (Set)

### CRF 1100 L Africa Twin / CRF 1100 L Adventure Sports

Protects the callipers against damage and is a treat for the eye!

The stainless steel guard is simple to install, rust-proof and easy to care for.

402-5497 black

402-5498 stainless steel



## Rear Brake Fluid Reservoir Guard

### CRF 1100 L Africa Twin / CRF 1100 L Adventure Sports

On the HONDA the brake fluid reservoir is all too easily accessible, putting it at risk of damage or tampering. Made from laser-cut stainless steel, Touratech's brake fluid reservoir guard effectively prevents damage and undesired access to the reservoir lid, yet you can still easily see the fluid level.

The guard simply bolts onto the existing mounting point.

403-5030 stainless steel black





## Guard for parking brake

CRF 1100 L Africa Twin / CRF 1100 L Adventure Sports

Protects the parking brake against damage and is a treat for the eye!

The stainless steel guard is simple to install, rust-proof and easy to care for.

402-5639

403-5639 black

## Comfort seat Fresh Touch one piece

CRF 1100 L Africa Twin / CRF 1100 L Adventure Sports

This seat significantly increases seating comfort, especially on long stretches.

The reason: the ultra-bi-elastic yet strong outer material, which makes the padding even more efficient. The integrated recess relieves the pressure on the coccyx and distributes the driver's weight over the whole seat. Thanks to the offset seams on the side and slim shape of the seat, there is no pressure against the thighs. All in all, a wonderful and comfortable seat for your Africa Twin!

403-5962 low

403-5963 standard

403-5964 high

## Fresh Touch

The high quality, multi-layer seat cover is equipped with a durable Fresh Touch surface coating.

It reduces the surface temperature by significantly reflecting infrared light radiation and providing a cooler feeling when mounting a motorcycle parked in the sun. An additional, exclusive gain in comfort for your riding pleasure!



-10 °C | -50 °F



## Touratech Professional toolsets, 70 pcs

Work like a pro!

The unique, innovative professional toolset is especially designed for the regular service and for repairing motorcycles on the way. The compact set covers all essential applications and is therefore an ideal companion, from day trips up to world trips.

A great compact tool set that allows you to do 80% of adjustments and repair works on your motorcycle.

070-2213



CRF 1100 L AFRICA TWIN

## Tool kit for Japanese and European motorcycles, CruzTools RoadTech RTM3

For modern motorcycles special tools are needed. Contents:

- Combination wrenches: 8 mm, 10 mm, 12 mm, 14 mm
- Other wrenches: 20,32 cm (8") Adjustable
- Pliers: 13,97 cm (5.5") curved jaw locking
- 0,64 cm (1/4") drive socket set: 48-tooth mini ratchet, 5,08 cm (2") Extension, 8 mm, 10 mm, 12 mm
- Hex keys: 3 mm, 4 mm, 5 mm, 6 mm
- Screwdriver: 6-in-1 reversible (2 Phillips, 2 Slotted, 6 mm and 8 mm Nut drivers)
- Spark plug socket 13/16 mm
- Spark plug gap gauge
- Tyre gauge (kPa-scale! -> 100kPa=1bar)
- Misc.: Locktite, tape, cable ties (5 pcs.), mechanical wire

070-2104





## Chain guard

CRF 1100L Africa Twin / CRF 1100L Adventure Sports

Touratech's chain guard for the Africa Twin. Much sturdier than the original plastic part, the Touratech chain guard is made from stainless steel and aluminium yet is still relatively light. Visually the metal chain guard fits much better with the overall concept of a touring enduro like the CRF 1100L.

The chain guard is simple and quick to fit as it attaches to the existing mounting points.

The chain guard can be adjusted in length by 50 mm.

403-5045 black



## Chain guard fin

CRF 1100L Africa Twin / CRF 1100L Adventure Sports

We have developed an efficient lower protection to match our chain guard (403-5045) from the same combination of aluminium/stainless steel. It is particularly effective off-road at preventing branches and other objects from knocking the chain of the rear sprocket.

The chain guard fin is stronger and yet much prettier than the original plastic item!

Existing fixation points can be used, which makes the chain guard much easier to attach.

403-5305 Aluminium / Stainless steel

## Splash guard under number plate

CRF 1100L Africa Twin / CRF 1100L Adventure Sports

For more than 10 years, Touratech splash guards have been watching the backs of riders and passengers, keeping them dry and clean. And protecting number plates from shaking loose. However, no matter how simple or good the product, development never stops. The Touratech splash guard has been specially adapted to the contours of the number plate holder. Beautifully integrated in the vehicle design, it is also suitable for smaller number plates.

- Made of black anodised aluminium
- Effective protection against splashes
- Also reinforces the number plate

632-5000





## Side stand base extension

CRF 1100 L Africa Twin / CRF 1100 L Adventure Sports

It's a familiar problem that has tested the temper of many motorcyclists. After riding your bike along rocky, bumpy off-road tracks, you just want to stop for a rest. But that's easier said than done. Parking your bike on soft ground can be a real problem! Usually you can't find a wooden board or something similar to stand the bike on when you need it. Touratech has the solution: the side stand base extension more than doubles the area of the supporting surface, so you won't find yourself straining to lift the fully loaded machine. A mix of stainless steel and black anodised aluminium components ensure the base extension looks good and provides full stability.

403-5275



## Brake lever extension

CRF 1100 L Africa Twin / CRF 1100 L Adventure Sports

It is particularly important when riding off-road to have the brake foot safely on the brake. Our brake lever extension will make sure that your boot always finds its way to the lever - and makes operation much easier and noticeably better.

Material: high quality stainless steel

403-5390



## Pivot Pegz - MK4

CRF 1100 L Africa Twin / CRF 1100 L Adventure Sports

Pivot Pegz MK4 now with 6 cm wide and 10 cm long tread for even better grip!

Thanks to a spring joint, these foot pegs follow the forward and backward movements of the foot to an angle of 20 degrees. This protects the boot, and gives the rider a better position on the bike - even in extreme situations.

040-5522

040-5525 Toppers

040-5522



## Works Long-Distance Foot Pegs

CRF 1100 L Africa Twin /  
CRF 1100 L Adventure Sports

- 52 mm wide and 4 mm thick stainless steel claw profile that is kind to your boots
- Perfect combination of grip and self-cleaning

403-5315





Extreme



Level 2 / PDS

# TOURATECH SUSPENSION

## Touratech Suspension shock absorbers

These shock absorbers for the Africa Twin CRF 1100L are perfectly suited to touring and riding with frequent dramatic changes in loading and riding conditions, and the most extreme demands. These shock absorbers can accommodate any luggage volume from a tail bag to a fully loaded luggage system and/or pillion passenger. You can easily and quickly restore the bike's balance via a hand wheel that adjusts the spring preload. The very fine damping adjustment on the external reservoir lets you adjust the suspension effectively and precisely to suit your personal riding style at any time, on any condition of road, and for any purpose – whether motorways, main roads, winding country lanes, off-road sections, long-distance travel with lots of luggage or for a snappy, daring riding style.

**You will experience a completely new ride feel on your motorbike.**

CRF 1100L Africa Twin

403-5861 Level 2 / PDS

403-5871 Extreme

**SHOWA EERA™**

Electronically  
Equipped  
Ride Adjustment

- 1 Standard
- 2 - 25 mm
- 3 + 20 mm

### Touratech Suspension progressive replacement springs for fork and shock absorber

Full set by Touratech Suspension, the specialist for suspension products. The set includes replacement fork springs and a replacement spring for the shock absorber. The progressive springs have been designed to match the new Africa Twin perfectly, and offer a tremendous improvement in response and greater safety in extreme situations. Replacing the front and rear

springs will lead to a significant improvement in your suspension system.

**Info:** Only fits HONDA CRF 1100L

Delivery includes detailed installation instructions, the correct fork oil and a paste to improve the slippage of the dip tubes.

**Our recommendation:** Have the replacement springs fitted by a specialist workshop.

**403-5839 CRF 1100L Africa Twin**

1

### Height lowering kit - 25 mm

The height lowering kit by Touratech Suspension, from the Dutch specialist Hyperpro. The set includes replacement fork springs and a replacement spring for the shock absorber. This spring set provides you with a sensible 25 mm reduction in height without affecting the riding properties - at the expense of a little ground clearance. The progressive springs have been designed to match the Honda CRF 1100L Africa Twin perfectly,

and offer a tremendous improvement in response and greater safety in extreme situations. Replacing the front and rear springs will lead to a significant improvement in your suspension system. Street legal.

**403-5842 CRF 1100L Africa Twin**

2

### Progressive front and rear replacement springs + 20 mm / Offroad Travel

These progressive replacement springs enable the ground clearance to be increased by + 20 mm. This gives a sportier response and increased reserves at the limit with the original spring elements. The springs are perfectly adapted to the original Honda CRF 1100L Africa Twin shock absorber and fork. After installation,

your motorbike will be inexpensively and ideally adapted to the demands of off-road motorcycling.

**403-5840 CRF 1100L Africa Twin**

**403-5841 CRF 1100L HEAVY LOAD**

3



**SHOWA EERA™**  
Electronically  
Equipped  
Ride Adjustment



### Progressive replacement fork springs, front

403-5835 CRF 1100 L Africa Twin

403-5843 Adventure Sports

403-5845 Adventure Sports EERA™

### Progressive fork springs + 20 mm / Offroad Travel

These progressive fork springs enable the front to be raised by 20 mm. This gives a sportier response and increased reserves at the limit with the original Honda fork. The fork springs are perfectly suited to the original Honda CRF 1100 L Africa Twin fork in combination with our Touratech Suspension shock absorbers. This gives the suspension system of your Honda CRF 1100 L Africa Twin considerably more reserves, perfectly preparing it for the demands of off-road motorcycling.

403-5836 CRF 1100 L Africa Twin

403-5837 CRF 1100 L Africa Twin HEAVY LOAD

### Progressive fork springs - 25 mm lowering

Replacement fork springs for lowering the front end by Dutch suspension specialists Hyperpro. This spring set provides you with a practical 25 mm reduction in height without worsening the riding characteristics - at the expense of a little ground clearance. These progressive springs have been designed to match the Honda CRF 1100 L Africa-Twin perfectly, offering a tremendous improvement in response and greater safety in extreme situations than the original fork springs.

403-5838 CRF 1100 L Africa Twin

## Touratech Suspension Cartridge Kit Extreme

Putting it simply, the Touratech Suspension Cartridge Kit Extreme is a suspension strut for the fork and the absolute top end in terms of suspension technology. The Closed Cartridge is installed into the original fork. This way the fork bridge/handlebar mount, brakes and wheel control and handlebar geometry are retained in full. No additional modifications to the fork are required

This Closed Cartridge has been developed perfectly for touring and riding with frequent and strongly differing loads and riding conditions or extreme requirements.

403-5875 CRF 1100L Africa Twin

## NOK fork seals and dust covers

Honda CRF 1100L Africa Twin / CRF 1100L Adventure Sports

Set for the complete fork.

058-0227



CRF 1100 L AFRICA TWIN

**TOURATECH**  
SUSPENSION

You will find further information  
on Touratech Suspension in our  
catalog starting on page 596!





### Tank bag Ambato Pure

This minimalist tank bag is a practical, well thought out piece of equipment that represents outstanding value for money.

Flatter in shape and with fewer adornments, this model is suitable for all kinds of uses. For instance, it provides enough space for a day trip, can hold documents, a mobile phone, wallet and drinks on the way to a city sightseeing tour, and is also the preferred choice for off-road riding as it doesn't restrict the rider's movements while standing or affect the bike's handling.

An ideal accessory providing excellent utility value at a great price.

Size: (l x w x h) approx. 35 x 27 x 20 cm

Volume: approx. 9 litres

Colour: black

402-5802 Africa Twin

402-5812 Adventure Sports



### Handlebar bag Ibarra

CRF 1100L Africa Twin / CRF 1100L ADV Sports

Practical storage space exactly where you need it! The sturdy handlebar provides enough space to attach an extremely practical and travel-worthy bag.

A wide opening water-repellent dustproof zip provides easy access to a large main compartment in which the things you need quickly -

a first aid kit, spare pair of gloves, breakdown kit or also your travel documents, wallet, sunglasses and mobile phone - are well protected.

A key feature is that our bag doesn't in any way restrict the rider's movements or affect control of the bike.

045-5827



402-5803



402-5804



### Tank bag Ambato Exp

It fits like a made-to-measure suit! As we develop and offer the exclusive base plates and strong attachment kits for our robust tank bags for each specific vehicle, it is a given that a perfect fit with no play at all is achieved! The Ambato Exp is also notable for the expansion option with an all-round zipper; small items can easily be stored under the adjustable elastic strap on the back.

Thanks to the water-repellent cable hole, it's now easy to charge a mobile phone in the tank bag – plus the side pockets have an expansion pleat, which means there's even more room inside them than you would think.

Size: (l x w x h) approx. 37 x 27 x 22/32 cm;  
Volume: approx. 13/20 litres

#### Africa Twin

402-5800	Black
402-5803	Tricolor
402-5804	Red

#### Adventure Sports

402-5810	Black
402-5813	Tricolor
402-5814	Red



## Pillion seat bag AMBATO EXP

CRF 1100 L Africa Twin / CRF 1100 L Adventure Sports

The perfect solution for more luggage: „Ambato Exp“! Anyone who expects more of a pillion bag than others really should take a closer look at the „Ambato Exp“ series! With two outer pockets, a large main compartment, the elastic drawstring on the top, the all-round zipper for when you want to increase its size and the practical carrying handle, this pillion bag can cope with any challenge! In looks, it matches the other luggage solutions in the Ambato series, and is easily attached to the vehicle-specific base by means of two easy-opening zippers.

Size: (l x w x h) approx. 35 x 26 x 18/25 cm; Volume: approx. 14/22 l

055-1282

## Pillion seat bag AMBATO PURE

CRF 1100 L Africa Twin / CRF 1100 L Adventure Sports

- Insert panels made from strong waterproof tarpaulin
- Sturdy body and top made from high-quality, water-resistant and abrasion-resistant 1100 Dtex Cordura
- Waterproof coating on inside of fabric
- Fluorocarbon impregnation and Teflon coating by DuPont using nanotechnology for protection against moisture, dirt, oil and fading
- Washable and easy to clean
- The fabric used has been tested for harmful substances and certified in accordance with OEKO-TEX Standard 100
- Reflective 3M Scotchlite panels for maximum visibility
- Made for extreme loads and built to last
- Perfect fit
- Securely attached but can be quickly taken off the bike
- Simply zips onto attachment kit with two sturdy, large-tooth, dirt-resistant zips
- Flat, narrow shape allows great freedom of movement for active off-road use

Size: (L x W x H) approx. 33 x 30 x 15 cm , Volume: approx. 14 litres

055-1283

## Bags AMBATO for Touratech crash bars

CRF 1100 L Africa Twin

The bags are sold in pairs, and fit on the Touratech crash bars 403-5160 till 403-5163. They are simply placed over the bar and secured by three straps.

Size (L x W x H): approx. 21 x 10 x 36 cm; Capacity: approx. 4,5 litres each side. Made of Teflon-coated CORDURA, which is both waterproof and dirt-resistant.

403-5820





## ZEGA Topcase / Luggage rack stainless steel

### CRF 1100 L Africa Twin

Made entirely of stainless steel and extremely robust, the topcase carrier is the perfect mount for ZEGA topcases. The design and function of the carrier was developed specifically for the requirements of the Africa Twin. A special bracket construction which is attached via the 4 available screw attachment points, provides extremely high stability and loading. Your luggage is secured safely, even under the most arduous conditions! In addition, the passenger hand grips are part of the carrier. And, of course, the top case can be secured without restricting the passenger. The carrier can be used alone or in conjunction with the case system.

Details:

- suitable for ZEGA Topcase XXL
- robust and safe
- integrated hand grips
- no passenger restriction
- can be used without the case system or as luggage bridge
- easy installation
- stainless steel

Delivery schedule does not include the Topcase

403-5455 stainless steel

403-5456 stainless steel black



403-5455



403-5456

CRF 1100 L AFRICA TWIN

## ZEGA Topcase rack

### CRF 1100 L Adventure Sports

You don't need any great mechanical skills to fit the Touratech luggage rack for the Zega Topcase to the standard luggage rack on the Honda. The luggage rack attaches securely to four mounting points and can withstand heavier loads than the original product. The Topcase itself is even easier to attach. With Touratech's ingenious RapidTrap mounting system, the Topcase quickly "clicks" on or off.

Made from electropolished stainless steel.

403-5457





## Luggage plate

### CRF 1100 L Africa Twin (2022-) / ADV Sports

Optimise the stowage of your luggage on your Honda! The luggage rack, made of 4 mm thick aluminium, is precisely laser-machined and virtually doubles the usable surface area of the original Honda luggage rack. The surface of your rack has great optics, the shape adapts elegantly to the motorbike's design. Numerous recesses and slots for straps offer a variety of lashing options. The wide design even offers large pieces of luggage a firm hold. The rack can be fitted quickly and easily.

The anodised version of the luggage plate doesn't just shine in its fabulous look. It also prevents effectively the abrasion, from setting on the Rack-Pack. The ultra thick, high quality anodised layer offers very special protection for the surface and helps to prevent discoloration.

Features:

- Precisely laser cut 4 mm aluminium
- Larger surface for your luggage, with slotted holes for straps
- Extremely sturdy design

Note: For Honda CRF 1100 L Africa Twin (-2021) please order 01-403-5450-0.

**403-5452**

## Luggage rack

### CRF 1100 L Africa Twin (-2021)

Optimise the stowage of your luggage on your Africa Twin! The luggage rack, made of 4 mm thick aluminium, is precisely laser-machined and virtually doubles the usable surface area of the original Honda luggage rack. The surface of your rack has great optics, the shape adapts elegantly to the motorbike's design. Numerous recesses and slots for straps offer a variety of lashing options. The wide design even offers large pieces of luggage a firm hold. The rack can be fitted quickly and easily.

**403-5450 Africa Twin**

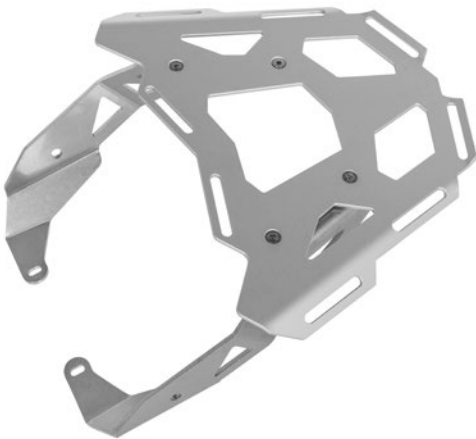

## Stainless steel pannier rack

### CRF 1100 L Africa Twin / CRF 1100 L ADV Sports

Touratech's stainless steel pannier rack for the Africa Twin is a sturdy rack designed to take Touratech ZEGA Evo, ZEGA Pro and ZEGA Mundo cases. This is the perfect case system for extended touring. Made of 18 mm stainless steel tubing, this non-rusting system matches the appearance of the Africa Twin frame and guarantees extra high stability even off the beaten track. Fitted as closely as possible to the vehicle frame using existing attachment points. Just a few screws is all it takes for the very strong construction to be securely attached (or removed). The angle brackets remain unobtrusive on the motorbike. Overall width: 56 cm

#### Africa Twin (-2021)

403-6555 Stainless steel

403-6560 Stainless steel black

#### Africa Twin (2022-) / ADV Sports

403-5555 Stainless steel

403-5560 Stainless steel black



403-6555





# ZEGA PRO

# ZEGA MUNDO

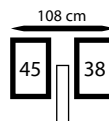
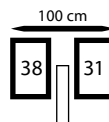

## ZEGA aluminium pannier system with stainless steel rack

The aluminium pannier system again has a very robust construction. We have tried to bring the pannier racks and the panniers as close as possible to the motorcycle. Numerous tests have

already been performed in order to ensure that the entire development satisfies the required demands. The rack is made of 18 mm steel tubing and is attached to existing mounting points using special fixing clips and reinforcing pieces. Pillion comfort not restricted in any way. Enhances the enduro and touring appearance.

### CRF 1100L Africa Twin (-2021)

Pannier System with:	stainless steel rack	stainless steel rack black
ZEGA Mundo 31/38 L	403-6130	403-6180
ZEGA Pro 31/38 L	403-5730	403-5780
ZEGA Pro AND-S 31/38 L	403-5731	403-5781
ZEGA Pro AND-Black 31/38 L	403-5732	403-5782

Pannier System with:	stainless steel rack	stainless steel rack black
ZEGA Mundo 38/45 L	403-6135	403-6185
ZEGA Pro 38/45 L	403-5735	403-5785
ZEGA Pro AND-S 38/45 L	403-5736	403-5786
ZEGA Pro AND-Black 38/45 L	403-5737	403-5787



More information about ZEGA cases from page **>436**



CRF 1100 L AFRICA TWIN

**Aluminium pannier systems with stainless steel rack**

CRF 1100 L Africa Twin (2022-) / Adventure Sports

Pannier System with:	stainless steel rack	stainless steel rack black
ZEGA Mundo 31/38 L	403-7130	403-7180
ZEGA Pro 31/38 L	403-6730	403-6780
ZEGA Pro AND-S 31/38 L	403-6731	403-6781
ZEGA Pro AND-Black 31/38 L	403-6732	403-6782

Pannier System with:	stainless steel rack	stainless steel rack black
ZEGA Mundo 38/45 L	403-7135	403-7185
ZEGA Pro 38/45 L	403-6735	403-6785
ZEGA Pro AND-S 38/45 L	403-6736	403-6786
ZEGA Pro AND-Black 38/45 L	403-6737	403-6787



# ZEGA EVO

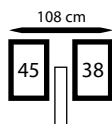
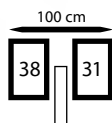

# ZEGA EVO



## Aluminium pannier systems with stainless steel rack

### CRF 1100 L Africa Twin / CRF 1100 L Adventure Sports

The ZEGA Evo, like all Touratech panniers before it, was not developed as an isolated product but was intended from the outset to be part of a luggage system. The outstanding practical benefits are the result of the unique combination of an elegant and

indestructible pannier, an ingenious fastening mechanism and a terrain-immune rack made of 18 mm thick stainless steel tubes. Matching inner pannier bags and practical accessory holders round off the luggage system.

### CRF 1100 L Africa Twin (~2021)

Pannier System with:	stainless steel rack	stainless steel rack black
ZEGA Evo AND-S 31/38 litres	403-6831	403-6881
ZEGA Evo AND-Black 31/38 litres	403-6832	403-6882
Pannier System with:	stainless steel rack	stainless steel rack black
ZEGA Evo AND-S 38/45 litres	403-6836	403-6886
ZEGA Evo AND-Black 38/45 litres	403-6837	403-6887

### CRF 1100 L Africa Twin (2022-) / Adventure Sports

Pannier System with:	stainless steel rack	stainless steel rack black
ZEGA Evo AND-S 31/38 litres	403-7831	403-7881
ZEGA Evo AND-Black 31/38 litres	403-7832	403-7882
Pannier System with:	stainless steel rack	stainless steel rack black
ZEGA Evo AND-S 38/45 litres	403-7836	403-7886
ZEGA Evo AND-Black 38/45 litres	403-7837	403-7887

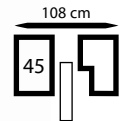
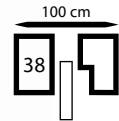

## ZEGA EVO X



### ZEGA Evo X special systems

CRF 1100 L Africa Twin /  
CRF 1100 L Adventure Sports

The ZEGA Evo, like all Touratech panniers before it, was not developed as an isolated product but was intended from the outset to be part of a luggage system. The outstanding practical benefits are the result of the unique combination of an elegant and indestructible pannier, an ingenious fastening mechanism and a terrain-immune rack made of 18 mm thick stainless steel tubes.

A typical feature of the special system is the recess on the right-hand pannier that allows it to nestle snugly against the exhaust. The panniers are positioned closer to the bike's centreline, the overall width is reduced, and the system as a whole appears more balanced thanks to the symmetrical pannier lids. Made from stainless steel, the sturdy pannier racks are scratch and rust resistant.



## CRF 1100L Africa Twin (~2021)

Special System with:	stainless steel rack	stainless steel rack black
ZEGA Evo AND-S 38/38 litres	403-6016	403-6066
ZEGA Evo AND-Black 38/38 litres	403-6017	403-6067

Special System with:	stainless steel rack	stainless steel rack black
ZEGA Evo AND-S 45/45 litres	403-6026	403-6076
ZEGA Evo AND-Black 45/45 litres	403-6027	403-6077

## CRF 1100L Africa Twin (2022-) / Adventure Sports

Special System with:	stainless steel rack	stainless steel rack black
ZEGA Evo AND-S 38/38 litres	403-7016	403-7066
ZEGA Evo AND-Black 38/38 litres	403-7017	403-7067

Special System with:	stainless steel rack	stainless steel rack black
ZEGA Evo AND-S 45/45 litres	403-7026	403-7076
ZEGA Evo AND-Black 45/45 litres	403-7027	403-7077

ZEGA EVO X





- 1 Handlebar | Cockpit | Windscreens | Lighting from p. 276
- 2 Engine guard | Fairing from p. 283
- 3 Seats page from p. 289
- 4 Suspension from p. 293
- 5 Foot pegs from p. 292
- 6 Soft luggage from p. 297
- 7 Pannier systems from p. 300

# HONDA

CRF 1000 L  
AFRICA TWIN

CRF 1000 L  
ADVENTURE  
SPORTS





402-6200



402-6210



402-6222



## Windscreen

### CRF 1000 L Africa Twin

Not satisfied with the original wind shield of your bike? Thanks to countless miles of adventure experience and to the know-how of our production department, we developed a wind shield that unites an appealing adventure design and an optimal function for every application.

Replace your original windscreen with the Touratech wind shield and discover much better driving properties! The form and function of the upper edge of the wind shield is based on our rally experience. The aerodynamic optimization guides the air streams over the head of the pilot without unnecessary turbulences.

So, the wind shield is not only flatter-free, it also guarantees a relaxed driving pleasure that doesn't exhaust the pilot nor the pillion passenger.

402-6200 S, transparent

402-6202 S, tinted

402-6210 M, transparent

402-6212 M, tinted

402-6220 L, transparent

402-6222 L, tinted



## Mounting kit for windscreen

### CRF 1000 L Adventure Sports

Necessary for mounting a Touratech windshield on your Honda CRF 1000L Africa Twin Adventure Sports.

402-6230

## Spoiler for windscreen, lockable

CRF 1000 L Africa Twin | CRF 1000 L ADV Sports

This special spoiler for the windscreen is perfect for undertaking long, fast motorbike journeys in comfort. There is a significant reduction in turbulence and wind pressure against the helmet.

It simply fits onto the windscreen, and is secured using the snap closure. When going off-road, the spoiler is easy to remove in seconds.

046-0647



CRF 1000 L AFRICA TWIN

## Windscreen spoiler Evo, with ABE

CRF 1000 L Africa Twin | Adventure Sports

Whether you need it for your original windscreen or as accessory to your new Touratech windscreen - with Touratech's windscreen spoiler Evo, you absolutely gain extra comfort on each terrain.

Evo offers the right balance between protection and ventilation - whether you drive on motorways, roads or off-road. Height, inclination and distance to the windscreen can easily be adjusted - you do not need any tools.

If you are going fast and the weather is rainy, fasten the spoiler at its highest level to benefit from an effective wind and weather protection. It is a noticeable relief for your head and upper body, and wind noises in your helmet are significantly reduced.

If you set the lowest level, the windscreen spoiler almost disappears. This guarantees maximum ventilation when riding off-road.

040-1380 transparent

040-1381 tinted

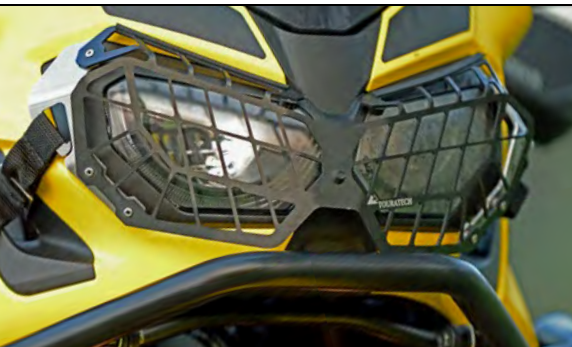

## Headlight Protector with Quick Release Fastener

CRF 1000 L Africa Twin / CRF 1000L Adventure Sports

Our headlight protector has been thoroughly tried and tested over the years – we've sold thousands.

Even the biggest stones won't be able to damage your headlight with this!

New model now available with quick release fastener! Now you can clip on the headlight protector and detach it again as needed. Just bolt the sturdy and secure side struts. And of course the protector comes with everything you need to fit it.

The headlight protector has been developed for off-road use and is not permitted in the scope of German StVO. Please check your national regulations!

402-5090 Makrolon

402-5095 Aluminum black



**OFFROAD  
USE ONLY**

## GPS handlebar bracket above the instruments

CRF 1000 L Africa Twin / CRF 1000 L Adventure Sports

402-5415

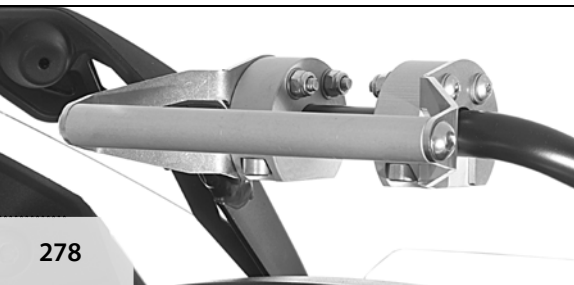

## Handlebar Riser

### CRF 1000 L Africa Twin / CRF 1000 L Adventure Sports

It's often the little things that make all the difference! This is the case with the Touratech handlebar riser for the Africa Twin.

A sporty driving style can often result in the handlebars twisting on the fork bridge. This is prevented by joining the handlebar mounts. (402-5254)

Raising the handlebar by 20 mm results in a more upright, much more relaxed seating position. The adjustment range of the handlebar angle is increased, which further increases rider comfort. The Touratech handlebar riser also makes riding while standing less tiring, which is of tremendous benefit to taller riders in particular.

The overall result is a noticeable increase in stamina and concentration. Long stretches on the motorway are less nerve-racking, and even fast, difficult sections off-road are easier to handle.

Material: aluminium.

402-5255 silver anodised

402-5254 joined, black



CRF 1000 L AFRICA TWIN

## GPS Handlebar Bracket Adapter GPS Bracket Adapter / Bracket for Navigation Systems

### CRF 1000 L Africa Twin / CRF 1000 L Adventure Sports

The bracket adapter is simply fitted to the handlebar mounting clamps on your Africa Twin. Our GPS brackets all fit perfectly on its 12-mm brace. For easy, safe attachment of your GPS. With no impairment of the view of the instruments.

402-5410

GPS handlebar bracket adapter with screws for handlebar risers 20 mm HONDA CRF 1000 L

402-5411





## Set of LED Auxiliary Headlights

CRF 1000 L Africa Twin / CRF 1000 L Adventure Sports

We use innovative LED headlights of 70 mm diameter for our auxiliary headlights.

The excellent light output is made possible by the latest lighting technology and high-performance LEDs with a higher level of efficiency. Power consumption just 13 watts per headlight! (Halogen: ~ 55 watts )

Set of LED auxiliary headlights fog / fog

402-5471

Set of LED auxiliary headlights fog right / full beam headlight left

402-5473



## Kaoko Cruise Control, mechanical cruise control

CRF 1000 L Africa Twin

The original by the South African inventor!

The Kaoko Cruise control replaces the original handlebar end weight. The anti-slip knurled screw secures the accelerator in position. This significantly reduces the strain on the right hand during long journeys. Thanks to the continuous adjustment, the accelerator can also be fixed to decelerate very gently - leaving you enough time to take your hand off the handlebar for a moment without immediately losing throttle. Despite that, the motorbike decelerates in a gentle and controlled way.

This item is illegal in road traffic in Germany and could be dangerous if used incorrectly. We are unable to accept any responsibility for it. Used at the owner's/ rider's own risk.

Fits with or without original handguards!

Fits with or without original handlebar heaters!



330-0051





### Touratech brake and clutch lever set, adjustable, folding and length adjustable

CRF 1000 L Africa Twin / CRF 1000 L Adventure Sports

The Touratech levers are milled from high-strength aluminum as in aircraft construction from the full. They are 6-way adjustable and hinged. In case of a fall the lever can fold up without breaking it. In normal operation, the levers are protected by a fold-up mechanism.

The levers are adjustable in length by dovetail connection by 35mm. The anodization meets the highest quality standards. All screw connections comply with the DIN standard and are tightened before delivery with the torque wrench.

The CNC levers are delivered with German ABE (General Operating Permit) and are therefore registration free.

402-5640



### Horn button protection

CRF 1000 L Africa Twin / CRF 1000 L Adventure Sports

You know the problem: with a fully packed tank bag and the handlebar turned nearly all the way, the horn button is pressed accidentally.

With our 1.5 mm thick, powder-coated stainless steel horn protection, the problem is gone for good. The horn protection is easily fitted with the existing instrument screw and is hardly noticeable. The functionality of the horn is not impaired in any way.

402-5120



## Hand protector

### CRF 1000 L Africa Twin / CRF 1000 L Adventure Sports

These hand protectors are made of virtually indestructible plastic; they are modern in design, offer a high level of protection, and can easily be fitted to the Honda using the fitting sets (included). The hand protector can be combined with various spoilers and then offers optimum protection against wind and weather.

A very strong, sturdy construction which has proven itself time and again in many rallies and on other motor cycles.

Also suitable for DCT.

402-5650 black

402-5654 white

## Spoiler for hand protectores

### CRF 1000 L Africa Twin / CRF 1000 L Adventure Sports

040-7301 black



## Stainless steel crash bar

### CRF 1000 L Africa Twin

The crash bar is made of high quality, electropolished stainless steel and extends the range of use of your travel enduro. The two-component crash bar was fitted as close as possible to the vehicle to give harmonious integration into the existing vehicle design. Its special design provides optimal force dissipation and largely protects the radiator as well as the tank and fairing against damage. The crash bar is simple to install, rust-proof and easy to care for.

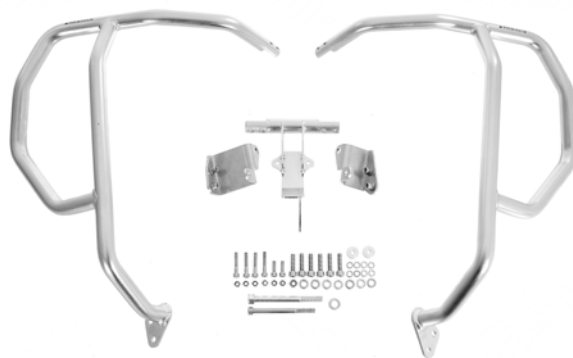

402-5160 stainless steel

402-5161 stainless steel black



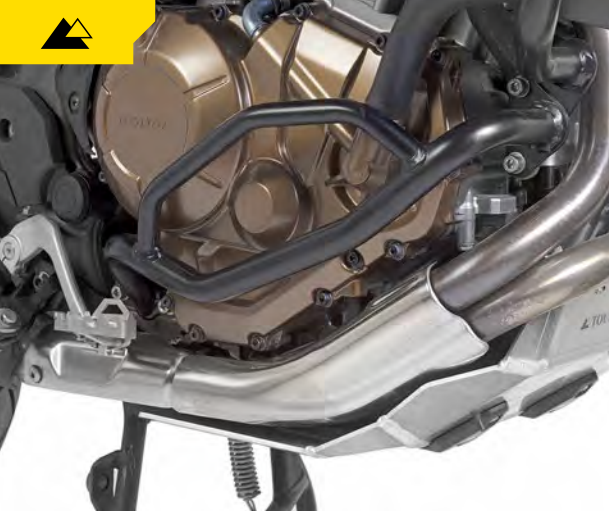

## Stainless Steel Engine Crash Bar

CRF 1000 L Africa Twin

Touratech's engine crash bar provides optimum protection for the engine's important side panels. Its slender design does not affect the lean angle at all and means you can ride on difficult single trails off-road as well as on-road. Made from resilient stainless steel, the engine crash bar gleams thanks to its high quality electropolished/black finish. It perfectly complements the sporty, aggressive lines of the HONDA CRF 1000L.

Together with the Touratech fairing crash bar for your Africa Twin, you need never fear a fall again!

DCT: Not with original Honda accessory DCT foot shift.

402-5155 silver

402-5156 silver DCT

402-5157 black

402-5158 black DCT

## Mount for Touratech engine crash bar with original crash bar

CRF 1000 L Africa Twin

With this mount you can combine the Touratech engine crash bar with the original Honda crash bar.

402-5159



## Engine protector RALLYE and RALLYE EXTREME

### CRF 1000 L Africa Twin

With our RALLYE and RALLYE EXTREME engine protector for the Honda CRF 1000 L Africa Twin we combine modern production techniques with a unique design for the best possible protection of the entire engine area of your bike! Under the toughest test conditions, the RALLYE EXTREME engine protector was able to demonstrate its strengths on the winning motorbike at the Hellas Rallye.

The engine protector blends in stylishly with the lines of your motorbike. Thanks to innovative production technology, there are no disturbing welds, which are often considered to be a vulnerable point. The recesses on the underside don't only look good. In the event of the protector having to live up to its name, they provide the shock absorbing and lightweight aluminium with a robust stiffness. And as well as that, the two parallel recesses allow the bike to almost

glide over obstacles. In this way, the energy of the impact is effectively dissipated, preventing jamming or snagging.

Decide which of the four variants is right for you! Only in combination with original manifold.

The RALLYE EXTREME engine protector is designed to withstand really tough use with the lowest possible weight. It fulfils the task of an engine crash bar. Similarly, we have deliberately not gone in for compatibility between the RALLYE EXTREME and the original Honda decorative frame.

**For the Africa twin with DCT, original Honda decorative frame or the Touratech engine crash bar, please order the RALLYE engine protector.**

402-5136 RALLYE, aluminium

402-5138 RALLYE, black

402-5135 RALLYE EXTREME

402-5137 RALLYE EXTREME black

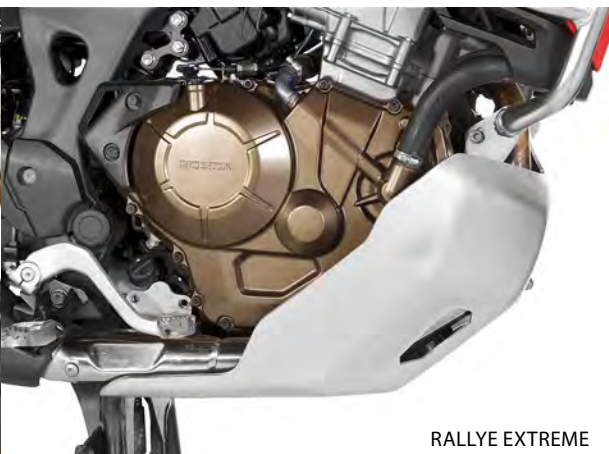

RALLYE EXTREME



RALLYE



### Rear Brake Fluid Reservoir Guard

CRF 1000 L Africa Twin / CRF 1000 L Adventure Sports

On the HONDA the brake fluid reservoir is all too easily accessible, putting it at risk of damage or tampering. Made from laser-cut stainless steel, Touratech's brake fluid reservoir guard effectively prevents damage and undesired access to the reservoir lid, yet you can still easily see the fluid level. The guard simply bolts onto the existing mounting point.

402-5032 (2018-) stainless steel

402-5033 (2018-) stainless steel black

### Guard for clutch cable, lower end

CRF 1000 L Africa Twin / CRF 1000 L Adventure Sports

Protects the lower end of the clutch cable and the open mechanic against damage and is a treat for the eye!

The aluminium guard is simple to install, rust-proof and easy to care for.

402-5516 black



## Chain guard

CRF 1000 L Africa Twin / CRF 1000 L Adventure Sports

Touratech's chain guard for the Africa Twin. Much sturdier than the original plastic part, the Touratech chain guard is made from stainless steel and aluminium yet is still relatively light. Visually the metal chain guard fits much better with the overall concept of a touring enduro like the CRF 1000 L.

The chain guard is simple and quick to fit as it attaches to the existing mounting points.

The chain guard can be adjusted in length.

402-5045 black

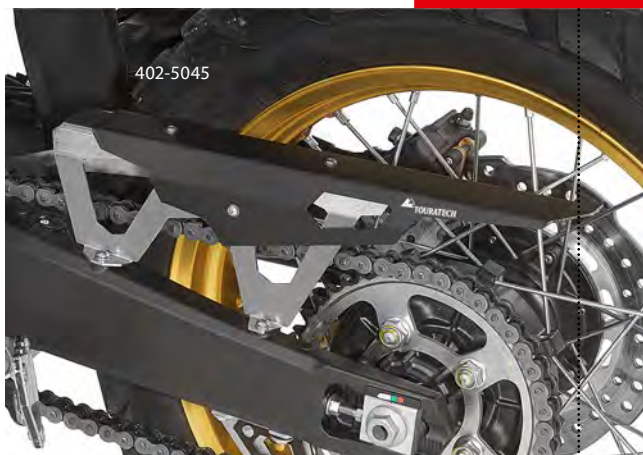

## Chain guard fin

CRF 1000 L Africa Twin / CRF 1000 L Adventure Sports

We have developed an efficient lower protection to match our chain guard (402-5045) from the same combination of aluminium/stainless steel. It is particularly effective off-road at preventing branches and other objects from knocking the chain of the drive sprocket.

The chain guard fin is stronger and yet much prettier than the original plastic item!

Existing fixation points can be used, which makes the chain guard much easier to attach.

402-5305 black



## Brake calliper guard front (Set)

CRF 1000 L Africa Twin / CRF 1000 L Adventure Sports

Protects the callipers against damage and is a treat for the eye!

The stainless steel guard is simple to install, rust-proof and easy to care for.

402-5497 black

402-5498 stainless steel





### Guard for parking brake

CRF 1000 L Africa Twin / CRF 1000 L Adventure Sports

Protects the parking brake against damage and is a treat for the eye!

The stainless steel guard is simple to install, rust-proof and easy to care for.

402-5639



### Brake lever extension

CRF 1000 L Africa Twin / CRF 1000 L Adventure Sports

It is particularly important when riding off-road to have the brake foot safely on the brake. Our brake lever extension will make sure that your boot always finds its way to the lever - and makes operation much easier and noticeably better.

Material: high quality stainless steel

402-5390





## Comfort Seat Fresh Touch

CRF 1000L Africa Twin / CRF 1000L ADV Sports

There are many ways to significantly improve the comfort and long-distance suitability of the standard seat on the new Africa Twin! For example, increasing the surface area of the seat is top of the wish lists of many riders and passengers. We provide the desired level of comfort by producing a larger, anatomically shaped foam core together with our own plastic base pan. The seat is perfect over long distances thanks to its high-quality, non-slip, bi-elastic covering material that provides a sweat-resistant surface.

Of course these seats also feature proven Touratech optimisations such as a hollowed recess to relieve coccyx pressure, a special contour on the pillion seat surface for support while braking and accelerating, and perfect positioning of the seams. All in all a great investment in the future of your CRF 1000L!

This high quality seat is supplied complete and ready-to-fit – there is no delay waiting for reupholstery work. It does not require any modifications to your motorbike and simply replaces the original seat, which you can keep.



**We also offer this popular comfort seat in our patented breathable version for the most discerning riders!**

The seat construction is based on an open-pored foam core with a spacer fabric around the seat to allow air to flow more easily through the ultra strong, elastic, water-proof textile cover. The result of this elaborate construction is overwhelming, and guarantees maximum riding comfort not only on long rides, but also at high outside temperatures and in extreme humidity. And yet there are no disadvantages or restrictions in normal every day use.





**Comfort seat one piece Fresh Touch**

402-5962	low
402-5963	standard
402-5964	high

**Comfort Seat one piece DriRide, breathable**

402-5916	standard
402-5917	high



**Comfort seat Fresh Touch**

402-5950	low
402-5951	standard
402-5952	high
402-5958	pillion

**Comfort Seat DriRide, breathable**

402-5904	standard
402-5905	high
402-5911	pillion



### Remus Okami silencer, slip-on with ABE certification

#### CRF 1000L Africa Twin / CRF 1000L Adventure Sports

The REMUS Okami will impress you with its unique appearance, the high quality material combination of stainless steel, carbon or titanium, and with the asymmetrical, hexagonal contour of the silencer body.

Its low weight and the optimised components also make the REMUS Okami a technical highlight. What's more,

the power and torque have been improved, giving the exhaust that distinctive REMUS sound.

402-5851	stainless steel, black (2016)
402-5852	titanium (2016)
402-5848	stainless steel, black (2017)
402-5847	titanium (2017)
402-5844	stainless steel, black (2018-)
402-5845	titanium (2018-)



## Works Long-Distance Foot Pegs

### CRF 1000 L Africa Twin (~2017)

- 52 mm wide and 4 mm thick stainless steel claw profile that is kind to your boots
- Perfect combination of grip and self-cleaning
- With a more slender design for better ground clearance
- Significantly less susceptible to impacts
- Strengthened mounting point
- With a blasted surface and laser inscription for a superior finish

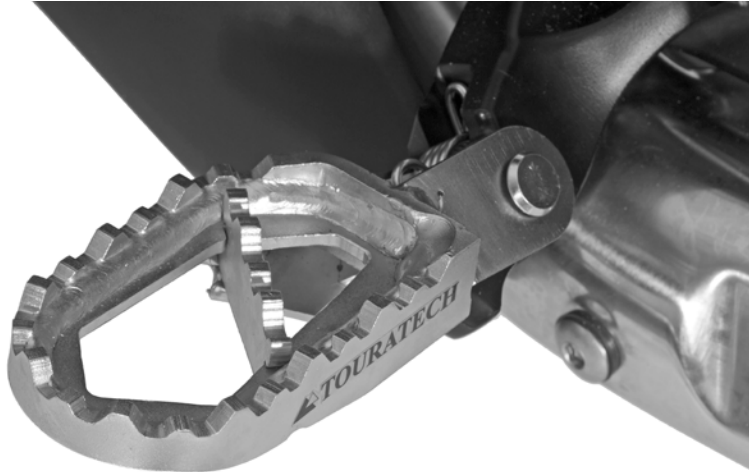

402-5315

## Pivot Pegz - MK4

Pivot Pegz MK4 now with 6 cm wide and 10 cm long tread for even better grip!

Thanks to a spring joint, these foot pegs follow the forward and backward movements of the foot to an angle of 20 degrees. This protects the boot, and gives the rider a better position on the bike - even in extreme situations.

040-5522 Africa Twin / ADV Sports (2018-)

040-5525 Toppers



## Side stand base extension

### CRF 1000 L Africa Twin / CRF 1000 L Adventure Sports

It's a familiar problem that has tested the temper of many motorcyclists. After riding your bike along rocky, bumpy off-road tracks, you just want to stop for a rest. But that's easier said than done. Parking your bike on soft ground can be a real problem! Usually you can't find a wooden board or something similar to stand the bike on when you need it. Touratech has the solution: the side stand base extension more than doubles the area of the supporting surface, so you won't find yourself straining to lift the fully loaded machine. A mix of stainless steel and black anodised aluminium components ensure the base extension looks good and provide full stability.

Securely fixed to the side stand, the base extension is a useful accessory that is always there to save you a lot of hassle and frustration.

402-5275



## Touratech Suspension shock absorbers

These shock absorbers for the Africa Twin CRF 1000 L are perfectly suited to touring and riding with frequent dramatic changes in loading and riding conditions, and the most extreme demands. These shock absorbers can accommodate any luggage volume from a tail bag to a fully loaded luggage system and/or pillion passenger. You can easily and quickly restore the bike's balance via a hand wheel that adjusts the spring preload. The very fine damping adjustment on the external reservoir lets you adjust the suspension effectively and precisely to suit your personal riding style at any time, on any condition of road, and for any purpose – whether motorways, main roads, winding country lanes, off-road sections, long-distance travel with lots of luggage or for a snappy, daring riding style.

You will experience a completely new ride feel on your motorbike.

### CRF 1000 L Africa Twin (-2017)

402-5860 Level 2 / Explore HP

402-5870 Extreme

### CRF 1000 L Africa Twin (2018-)

402-5861 Level 2 / Explore HP

402-5871 Extreme

### CRF 1000 L Adventure Sports

402-5862 Level 2 / Explore HP

402-5872 Extreme

Level 2 / Explore HP



Extreme

CRF 1000 L AFRICA TWIN

## Touratech Suspension lowering shock

This shock absorber is perfect to reduce the seat height on the Honda CRF 1000 L Africa Twin. Your Honda CRF 1000 L Africa Twin stays well tuned and ideally suited to touring use.

### Level 2 / Explore HP

402-5865 -25 mm (-2017)

402-5866 -25 mm (2018-)

402-5867 -25 mm Adv. Sports

402-5863 -40 mm Adv. Sports

### Extreme

402-5878 -25 mm (-2017)

402-5879 -25 mm (2018-)

402-5873 -25 mm Adv. Sports

402-5864 -40 mm Adv. Sports





# TOURATECH SUSPENSION

- 1 Standard
- 2 + 20 mm
- 3 - 25 mm

## SET

### Touratech Suspension progressive replacement springs for fork and shock absorber

Full set by Touratech Suspension, the specialist for suspension products. The set includes replacement fork springs and a replacement spring for the shock absorber. The progressive springs have been designed to match the new Africa Twin perfectly, and offer a tremendous improvement in response and greater safety in extreme situations. Replacing the front and rear springs will lead to a significant improvement in your

suspension system. Delivery includes detailed installation instructions, the correct fork oil and a paste to improve the slippage of the dip tubes.



**Info:** Only fits HONDA CRF 1000 L

**Our recommendation:** have the replacement springs fitted by a specialist workshop.

402-5836	(-2017)
402-5882	(2018-)
402-5842	Adventure Sports

### Progressive front and rear replacement springs +20 mm

These progressive replacement springs enable the ground clearance to be increased by 20 mm. This gives a sportier response and increased reserves at the limit with the original spring elements. The springs are perfectly adapted to the original Honda CRF 1000 L Africa

Twin shock absorber and fork. After installation, your motorbike will be inexpensively and ideally adapted to the demands of off-road motorcycling.



402-5834	(-2017)
402-5883	(2018-)
402-5885	Adventure Sports

### Height lowering kit -25 mm

The height lowering kit by Touratech Suspension, from the Dutch specialist Hyperpro. The set includes replacement fork springs and a replacement spring for the shock absorber. This spring set provides you with a sensible 25 mm reduction in height without affecting the riding properties - at the expense of a little ground clearance. The progressive springs have been designed to match the Honda CRF 1000 L Africa Twin perfectly,

and offer a tremendous improvement in response and greater safety in extreme situations. Replacing the front and rear springs will lead to a significant improvement in your suspension system. Street legal.



402-5838	(-2017)
402-5884	(2018-)
402-5843	Adventure Sports



### Progressive replacement fork springs, front

These progressive fork springs are perfectly matched to the fork on the Honda CRF 1000 L Africa Twin. They make the fork better suited to the demands of motorcycle touring. You will also experience a significantly improved response and greater reserves in extreme situations.

402-5835 (-2017)

402-5846 (2018-)

402-5839 Adventure Sports

### Progressive fork springs +20 mm / Offroad Travel

These progressive fork springs enable the front to be raised by 20 mm. This gives a sportier response and increased reserves at the limit with the original Honda fork. The fork springs are perfectly suited to the original Honda CRF 1000 L Africa Twin fork in combination with our Touratech Suspension shock absorbers. This gives the suspension system of your Honda CRF 1000 L Africa Twin considerably more reserves, perfectly preparing it for the demands of off-road motorcycling.

402-5833 (-2017)

402-5880 (2018-)

402-5840 Adventure Sports

### Progressive fork springs -25 mm lowering

Replacement fork springs for lowering the front end by Dutch suspension specialists Hyperpro. This spring set provides you with a practical 25 mm reduction in height without worsening the riding characteristics - at the expense of a little ground clearance. These progressive springs have been designed to match the Honda CRF 1000 L Africa Twin perfectly, offering a tremendous improvement in response and greater safety in extreme situations than the original fork springs.

402-5837 (-2017)

402-5881 (2018-)

402-5841 Adventure Sports



## Touratech Suspension Cartridge Kit Extreme

Putting it simply, the Touratech Suspension Cartridge Kit Extreme is a suspension strut for the fork and the absolute top end in terms of suspension technology. The Closed Cartridge is installed into the original fork. This way the fork bridge/handlebar mount, brakes and wheel control and handlebar geometry are retained in full. No additional modifications to the fork are required.

This Closed Cartridge is been developed perfectly for touring and riding with frequent and strongly differing loads and riding conditions or extreme requirements.

402-5875	(-2017)
402-5891	(2018-)
402-5876	Adventure Sports
402-5877	-25 mm (-2017)
402-5890	-25 mm (2018-)
402-5892	-25 mm Adv. Sports
402-5893	-40 mm Adv. Sports

## NOK fork seals and dust covers

Honda CRF 1000L Africa Twin/ CRF 1000L Adventure Sports

Set for the complete fork.

058-0227



# TOURATECH SUSPENSION

You will find further information  
on Touratech Suspension in our  
catalog starting on page 596!





### Tank bag Ambato Pure

This minimalist tank bag is a practical, well thought out piece of equipment that represents outstanding value for money.

Flatter in shape and with fewer adornments, this model is suitable for all kinds of uses. For instance, it provides enough space for a day trip, can hold documents, a mobile phone, wallet and drinks on the way to a city sightseeing tour, and is also the preferred choice for off-road riding as it doesn't restrict the rider's movements while standing or affect the bike's handling.

An ideal accessory providing excellent utility value at a great price.

Size: (l x w x h) approx. 35 x 27 x 20 cm

Volume: approx. 9 litres

Colour: black

402-5802 Africa Twin

402-5812 Adventure Sports

CRF 1000 L AFRICA TWIN



### Handlebar bag Ibarra

CRF 1000 L Africa Twin / CRF 1000 L ADV Sports

Practical storage space exactly where you need it! The sturdy handlebar provides enough space to attach an extremely practical and travel-worthy bag.

A wide opening water-repellent dustproof zip provides easy access to a large main compart-

ment in which the things you need quickly - a first aid kit, spare pair of gloves, breakdown kit or also your travel documents, wallet, sunglasses and mobile phone - are well protected.

A key feature is that our bag doesn't in any way restrict the rider's movements or affect control of the bike.

045-5827



### Tank bag Ambato EXP

It fits like a made-to-measure suit! As we develop and offer the exclusive base plates and strong attachment kits for our robust tank bags for each specific vehicle, it is a given that a perfect fit with no play at all is achieved! The Ambato EXP is also notable for the expansion option with an all-round zipper; small items can easily be stored under the adjustable elastic strap on the back.

Thanks to the water-repellent cable hole, it's now easy to charge a mobile phone in the tank bag – plus the side pockets have an expansion pleat, which means there's even more room inside them than you would think.

Size: (l x w x h) approx. 37 x 27 x 22/32 cm;  
Volume: approx. 13/20 litres

#### Africa Twin

- 402-5800 Black
- 402-5803 Tricolor
- 402-5804 Red

#### Adventure Sports

- 402-5810 Black
- 402-5813 Tricolor
- 402-5814 Red

## Pillion seat bag Ambato EXP

CRF 1000 L Africa Twin / CRF 1000 L Adventure Sports

The perfect solution for more luggage: „Ambato Exp"! Anyone who expects more of a pillion bag than others really should take a closer look at the „Ambato EXP" series! With two outer pockets, a large main compartment, the elastic drawstring on the top, the all-round zipper for when you want to increase its size and the practical carrying handle, this pillion bag can cope with any challenge! In looks, it matches the other luggage solutions in the Ambato series, and is easily attached to the vehicle-specific base by means of two easy-opening zippers.

Size: (l x w x h) approx. 35 x 26 x 18/25 cm; Volume: approx. 14/22 l

055-1282



## Bags Ambato for crash bars

CRF 1000 L Africa Twin

The bags are sold in pairs, and fit on the Touratech crash bars 402-5160/402-5161. They are simply placed over the bar and secured by three straps. Made of Teflon-coated CORDURA, which is both waterproof and dirt-resistant.

Size (L x W x H): approx. 21 x 10 x 36 cm; Capacity: approx. 4,5 litres each side.

402-5820



## Bags Ambato for original Honda crash bars

CRF 1000 L Africa Twin / CRF 1000 L Adventure Sports

The bags are sold in pairs, and fit on the original Honda crash bar of the CRF 1000 L Africa Twin and the CRF 1000 L Adventure Sports.

Made of Teflon-coated CORDURA, which is both waterproof and dirt-resistant.

Size: approx. 18 x 8 x 30 cm

402-5825



## Tail Rack Bag Ambato

CRF 1000 L Africa Twin / CRF 1000 L Adventure Sports

The practical and extendable rear bag is easy to mount on all Touratech luggage bridges using the three supplied straps and offers plenty of room for all those smaller items, for example, the rain suit or extra gloves.

And, of course, it fits virtually all of the original luggage bridges of most vehicles, it only requires a basic area of 27 x 17 cm!

055-1298





## Luggage racks

CRF 1000 L Africa Twin / CRF 1000 L ADV Sports

The luggage racks are made of 18 mm stainless steel round tubing and are extremely solid.

–2017

402-5560 black

2018–

402-6556 black

402-6555 stainless steel



402-6555

## Zega Topcase rack

CRF 1000 L Africa Twin / CRF 1000 L ADV Sports

The special carrier for our ZEGA Pro/ Evo-Topcases (stainless steel).

Africa Twin

402-5455 stainless steel

Adventure Sports

402-6455 stainless steel



402-5455

## Luggage rack

CRF 1000 L Africa Twin / CRF 1000 L ADV Sports

Optimise the stowage of your luggage on your Africa Twin! The luggage rack, made of 4 mm thick aluminium, is precisely laser-machined and virually doubles the usable surface area of the original Honda luggage rack. The surface of your rack has great optics, the shape adapts elgantly to the motorbike's design. Numerous recesses and slots for straps offer a variety of lashing options. The wide design even offers large pieces of luggage a firm hold. The rack can be fitted quickly and easily.

402-5450 Africa Twin

402-5453 Africa Twin, black

402-6450 ADV Sports



# ZEGA PRO

# ZEGA MUNDO



## ZEGA aluminium pannier system

### CRF 1000L Africa Twin (~2017)

The aluminium pannier system again has a very robust construction. We have tried to bring the pannier racks and the panniers as close as possible to the motorcycle. Numerous tests have

already been performed in order to ensure that the entire development satisfies the required demands. The rack is made of 18 mm steel tubing and is attached to existing mounting points using special fixing clips and reinforcing pieces. Pillion comfort not restricted in any way. Enhances the enduro and touring appearance.

Pannier System with:	stainless steel rack	stainless steel rack black
ZEGA Mundo 31/38 L	402-6130	402-6180
ZEGA Pro 31/38 L	402-5730	402-5780
ZEGA Pro AND-S 31/38 L	402-5731	402-5781
ZEGA Pro AND-Black 31/38 L	402-5732	402-5782

Pannier System with:	stainless steel rack	stainless steel rack black
ZEGA Mundo 38/45 L	402-6135	402-6185
ZEGA Pro 38/45 L	402-5735	402-5785
ZEGA Pro AND-S 38/45 L	402-5736	402-5786
ZEGA Pro AND-Black 38/45 L	402-5737	402-5787

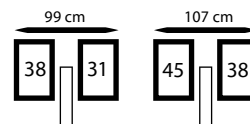



# ZEGA PRO

# ZEGA MUNDO



Aluminium pannier systems with stainless steel rack

CRF 1000 L Africa Twin (2018-) / CRF 1000 L Adventure Sports

Pannier System with:	stainless steel rack	stainless steel rack black
ZEGA Mundo 31/38 L	402-7130	402-7180
ZEGA Pro 31/38 L	402-6730	402-6780
ZEGA Pro AND-S 31/38 L	402-6731	402-6781
ZEGA Pro AND-Black 31/38 L	402-6732	402-6782

Pannier System with:	stainless steel rack	stainless steel rack black
ZEGA Mundo 38/45 L	402-7135	402-7185
ZEGA Pro 38/45 L	402-6735	402-6785
ZEGA Pro AND-S 38/45 L	402-6736	402-6786
ZEGA Pro AND-Black 38/45 L	402-6737	402-6787

## ZEGA MUNDO

## ZEGA PRO

## ZEGA EVO



More information  
about ZEGA cases  
from page

**>436**

# ZEGA EVO

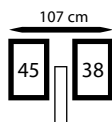
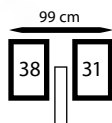

CRF 1000 L AFRICA TWIN





# ZEGA EVO

## Aluminium pannier systems with stainless steel rack

### CRF 1000L Africa Twin / CRF 1000L Adventure Sports

The ZEGA Evo, like all Touratech panniers before it, was not developed as an isolated product but was intended from the outset to be part of a luggage system. The outstanding practical benefits are the result of the unique combination of an elegant and

indestructible pannier, an ingenious fastening mechanism and a terrain-immune rack made of 18 mm thick stainless steel tubes. Matching inner pannier bags and practical accessory holders round off the luggage system.

### CRF 1000L Africa Twin (-2017)

Pannier System with:	stainless steel rack	stainless steel rack black
ZEGA Evo AND-S 31/38 litres	402-6831	402-6881
ZEGA Evo AND-Black 31/38 litres	402-6832	402-6882
Pannier System with:	stainless steel rack	stainless steel rack black
ZEGA Evo AND-S 38/45 litres	402-6836	402-6886
ZEGA Evo AND-Black 38/45 litres	402-6837	402-6887

### CRF 1000L Africa Twin (2018-) / CRF 1000L Adventure Sports

Pannier System with:	stainless steel rack	stainless steel rack black
ZEGA Evo AND-S 31/38 litres	402-7831	402-7881
ZEGA Evo AND-Black 31/38 litres	402-7832	402-7882
Pannier System with:	stainless steel rack	stainless steel rack black
ZEGA Evo AND-S 38/45 litres	402-7836	402-7886
ZEGA Evo AND-Black 38/45 litres	402-7837	402-7887



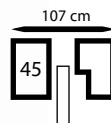
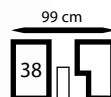

## ZEGA EVO X

CRF 1000 L AFRICA TWIN

### ZEGA Evo X special systems

CRF 1000 L Africa Twin (2018-) /  
CRF 1000 L Adventure Sports

The ZEGA Evo, like all Touratech panniers before it, was not developed as an isolated product but was intended from the outset to be part of a luggage system. The outstanding practical benefits are the result of the unique combination of an elegant and indestructible pannier, an ingenious fastening me-

chanism and a terrain-immune rack made of 18 mm thick stainless steel tubes.

A typical feature of the special system is the recess on the right-hand pannier that allows it to nestle snugly against the exhaust. The panniers are positioned closer to the bike's centreline, the overall width is reduced, and the system as a whole appears more balanced thanks to the symmetrical pannier lids. Made from stainless steel, the sturdy pannier racks are scratch and rust resistant.

Special System with:	stainless steel rack	stainless steel rack black
ZEGA Evo AND-S 38/38 litres	402-7016	402-7066
ZEGA Evo AND-Black 38/38 litres	402-7017	402-7067

Special System with:	stainless steel rack	stainless steel rack black
ZEGA Evo AND-S 45/45 litres	402-7026	402-7076
ZEGA Evo AND-Black 45/45 litres	402-7027	402-7077



- 1 Handlebar | Cockpit | Windscreens | Lighting from page 308
- 2 Tank bag from page 309
- 3 Tail rack bag from page 311
- 4 Protection from page 313
- 5 Case systems from page 318

# HARLEY- DAVIDSON

PAN AMERICA™ 1250





## TFT anti-theft

### Harley-Davidson Pan America™ 1250

The TFT display of your Harley is more than just a display instrument. It is the central communication unit in the interaction between man and machine. With its extensive functionalities, it is unfortunately also a very expensive component.

Did you know that your TFT display is only secured with three rather weakly dimensioned retaining rings? One strong pull on the housing and the entire TFT unit is gone. With the TFT theft protection, this quick but expensive "theft" is impossible!

The version with "sun visor" also has a 45mm anti-glare screen. The simultaneous use of Touratech navigation device holders is not restricted.

**2 mm black anodised aluminium, with sun visor**

440-5178



## GPS mounting adapter above instruments

### Harley-Davidson Pan America™ 1250

Our „mounting adapter above instruments“ lets you keep your GPS device or road book firmly in view.

No more looking down or distractions to the side – your eyes are always pointed at the road.

440-5415

## Folding mirror, length adjustable

Universal folding mirror, length and angle continuously adjustable.

- suitable for use on left or right
- carries the E test mark.

040-0760





440-5095

### Headlight Protector with Quick Release Fastener

Harley-Davidson Pan America™ 1250

Our headlight protector has been thoroughly tried and tested over the years – we've sold thousands.

Even the biggest stones won't be able to damage your headlight with this!

New durable stainless steel model now available with quick release fastener! Now you can clip on the headlight protector and detach it again as needed. Just bolt the sturdy and secure side struts. And of course the protector comes with everything you need to fit it. This headlight protector has been developed for off-road use and is not street legal.

Stainless steel headlight protector black

440-5095

Headlight protector Makrolon

440-5090

**OFFROAD  
USE ONLY**



### Handlebar bag IBARRA

Practical storage space exactly where you need it!

The sturdy handlebar provides enough space to attach an extremely practical and travel-worthy bag.

Volume: approx. 2 litres

045-5827



## Handlebar bag Ibarra Smart

Practical storage space and waterproof smart-phone holder - always within reach!

The highlight of our "Ibarra Smart" is the waterproof compartment for all common smartphones (up to approx. 9x16 cm). Thanks to a small opening you can connect your charging cable.

Under the lid there is a large, weatherproof main compartment (approx. 2.4 litres) for first aid kits, high-visibility vests or sunglasses. A further, smaller compartment allows quick access to important documents and other small items. The yellow lining helps you to find the contents of the bag more easily.

A key feature is that our bag doesn't in any way restrict the rider's movements or affect control of the bike. The use of certified Cordura guarantees highest material quality.

Dimensions: (L x W x H) approx. 33/17 x 8 x 13 cm

Volume: approx. 2.4 litres

055-1285

## Tank Bag EXTREME Edition

### Harley-Davidson Pan America 1250

This waterproof tank bag was specially designed for large adventure motorcycles. The already large capacity of approx. 14 litres can be extended to up to approx. 22 litres by means of the all-round zip. The main compartment can be individually adjusted using the interior divider. Small items can be placed in the two net pockets on the outside or in the small additional pockets in the weather-protected interior of the tank bag. The map pocket is also waterproof, of course, and has a cable entry for a smartphone or tablet. A removable pocket offers space for your wallet, car documents, passport, visas, keys,...

The tank bag is attached in the typical Touratech manner by means of a retaining kit with clips and Velcro that remains on the vehicle. Refueling is therefore quick and uncomplicated. The tensioning straps provide an even better hold in off-road conditions.

055-1011



### Pillion seat bag EXTREME Edition

The waterproof pillion bag is the perfect luggage supplement for the solo adventurer. With the robust Velcro straps, the bag can be universally attached to almost any pillion seat.

On the top flap and on the weather-protected inside of the top flap, there are mesh pockets that hold small items. The reflector on the back offers passive safety. The already large capacity of approx. 12 litres can be extended to up to approx. 18 litres by means of the all-round zip. The main compartment can be individually adjusted using the interior divider.

055-1009



### Tail Rack Bag+ EXTREME Edition

Harley-Davidson Pan America™ 1250

This waterproof tail rack bag+ was specially designed for Touratech luggage racks, but also fits most standard luggage racks. Thanks to the extra-long straps, the bag can also be mounted on almost any pillion seat. The already large capacity of approx. 8 litres can be extended to up to 12 litres by means of the all-round zip. On the top flap and on the weather-protected inside of the top flap, there are mesh pockets that hold small items. The reflector on the back offers passive safety.

055-1006





## WORKS Long-Distance Foot Pegs with ABE

### Harley-Davidson Pan America™ 1250

- 52 mm wide and 4 mm thick stainless steel claw profile that is kind to your boots
- Perfect combination of grip and self-cleaning
- With a more slender design for better ground clearance
- Significantly less susceptible to impacts
- Strengthened mounting point
- With a blasted surface and laser inscription for a superior finish

440-5315

440-5320 \*low\* -20 mm

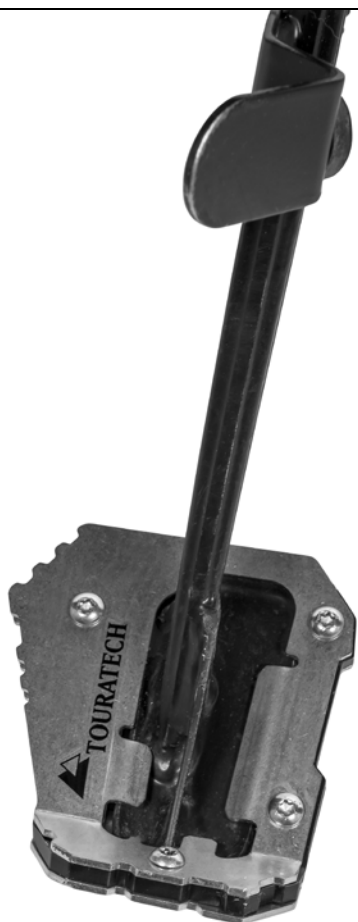

## Side stand base extension

### Harley-Davidson Pan America™ 1250

It's a familiar problem that has tested the temper of many motorcyclists. After riding your bike along rocky, bumpy off-road tracks, you just want to stop for a rest. But that's easier said than done. Parking your bike on soft ground can be a real problem! Usually you can't find a wooden board or something similar to stand the bike on when you need it. Touratech has the solution: the side stand base extension more than doubles the area of the supporting surface, so you won't find yourself straining to lift the fully loaded machine. A mix of stainless steel and black anodised aluminium components ensure the base extension looks good and provide full stability.

Securely fixed to the side stand, the base extension is a useful accessory that is always there to save you a lot of hassle and frustration.

440-5275 Pan America

440-5276 Pan America Special



### Tube manifold cover

Harley-Davidson Pan America™ 1250

Protects from stones and heavy soiling. Also the appearance of the bare pipe is enhanced. It prevents direct contact to the hot exhaust pipe which can melt your nylon riding gear. The manifold cover is made of high grade steel. Parts supplied: 1 guard incl. 2 stainless steel pipe clips

440-5065

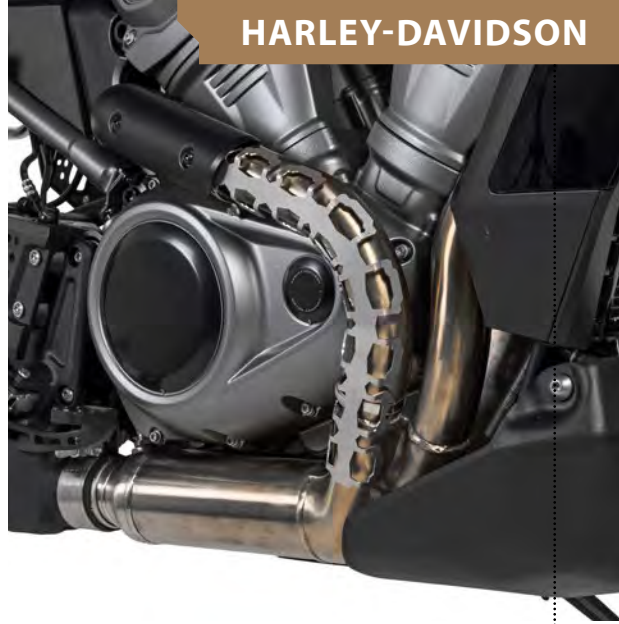

### Radiator protector black

Harley-Davidson Pan America™ 1250

The Touratech radiator protector shields the vulnerable lamellae of the radiator against damage and thus provides an enormous safety benefit! The dread of flying stones, sticks or other debris will be no more. A small investment will make your trip a whole lot safer! Optically unobtrusive yet in the unmistakable Touratech-style, the radiator protector made of laser cut aluminium blends in with the Harley design perfectly.

440-5015

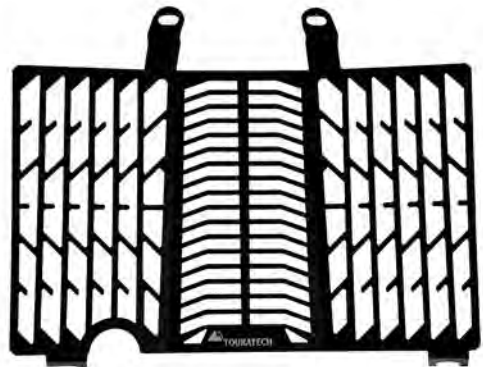



440-5651



372-5660



372-5661

## Hand protectors DEFENSA

### Harley-Davidson Pan America™ 1250

Whether off-road riding or touring – the Touratech Defensa offers reliable protection for handlebar fittings and hands, so that a minor mishap does not turn into a major problem. With the Defensa, Touratech has developed an extra-robust protector for handlebar fittings and hands. The construction made of high-strength aircraft aluminium is precisely adapted to your motorbike model. Thanks to the „Defensa System“, the protector offers interesting variation possibilities. Whether you choose a pure protector or a wide protector with an extra spoiler... Defensa hand protectors – for a particularly wide range of uses. The handlebar fittings are among the most vulnerable assemblies on a motorbike. The solid protector reliably protects the levers from damage. The closed protectors have a bracket that is supported near the clamping blocks as well as at the end of the handlebars, thus completely framing the armature. This principle has proven itself in rally motorbikes under the toughest conditions. The system consists of two bolted main components and an attachment kit. There is always the required space behind the protector so that the levers can move freely. The annoying hitting, especially of the

clutch lever, on the protector, as known from universal products, is a thing of the past with the Defensa. The components of the Defensa are made of a high-strength forged aluminium alloy, as proven in aircraft construction. With a thickness of 14 millimetres, the dimensions have been chosen generously without losing sight of the issue of weight. Precision manufacturing ensures excellent dimensional accuracy and thus a precise fit. The model-specific adaptation ensures tension-free installation and full steering angle.

#### Simple adaptation for on- and off-road use

For pure off-road use, it is recommended to use the Defensa „Pure“ version, where only the bar is mounted. For mixed use, there is the Defensa „Expedition“, which is fitted with a plastic wind deflector. The plastic shell is slid over the main hoop and clamped to the screw connection of the two aluminium components, ensuring a precise and secure fit. If you need even more weather protection, you can also fit the separately available „Extension“ spoiler. Of course, the Defensa Expedition can easily be converted back to the Pure.

#### Defensa Pure

440-5650 silver

440-5660 black

#### Defensa Expedition

440-5651 silver / black

440-5652 silver / white

440-5661 black / black

440-5662 black / white

#### Defensa Extension

102-5651 black

102-5652 white



Defensa EXPEDITION  
+ EXTENSION



## Engine Guard EXPEDITION

Harley-Davidson Pan America™ 1250

Series damage, such as holes in the engine block, can be effectively prevented by fitting the large Touratech engine guard. Maximum strength is provided by multiple folded ridges in the 4 mm thick aluminium base plate, while two additional lower 4 mm stainless steel attachment plates on the engine ensures the force of an impact is distributed over a large area via 6 bolting points. Ground clearance is not restricted by these two base plates.

440-5140





## Crash bar stainless steel, black

### Harley-Davidson Pan America™ 1250

The Pan America is the first true Adventure Bike by Harley-Davidson. We have used our long years of experience to make it even more suitable for travels using Touratech's developments. With a Touratech crash bar, you do not only visually prepare your Pan America for the next adventure.

The Touratech crash bar also offers several advantages over the models of other manufacturers and is significantly more suitable for practical use than the one originally offered by Harley-Davidson.

- The 3-Point-Mounting is extended by an additional, rear strut, thereby ensuring a higher stability and improved energy conduction in case of a fall
- The larger cap extends the protected area, starting at the cooler and extending beyond the front cylinder head
- Thanks to the special shaping, the full area of the cooler's fairing is protected
- In addition, it is possible to transport luggage using the protector

Of course, the Touratech crash bar is made of extremely robust and rust-free stainless steel tubes, as is usual for Touratech as opposed to the original part by Harley-Davidson. No worries about rust, even if the plastic cover should be scratched!

The high processing quality of products "Made in Germany", a tube diameter of 25 mm and a wall thickness of 2 mm probably makes the bars the most stable Pan America crash bar on the market.

The mounting is extremely easy and there are no restrictions concerning previously existing motor protectors.

440-5161





### ZEGA Topcase Rack

Harley-Davidson Pan America™ 1250

The special mounting for our ZEGA topcases. Made entirely of stainless steel and extremely robust, the topcase carrier is the perfect mount for ZEGA Pro and Evo topcases. The design and function of the carrier was developed specifically for the requirements of the Harley Pan America.

In addition, the passenger hand grips are part of the carrier. And, of course, the topcase can be secured without restricting the passenger. The carrier can be used alone or in conjunction with the case system.

440-5456 black

### Luggage plate for Touratech Topcase rack

Harley-Davidson Pan America™ 1250

Do you need more stability for large soft luggage on your Touratech topcase carrier? This luggage plate increases the contact surface, is super stable and allows even large pieces of luggage to be securely fastened.

- fits on every Touratech topcase carrier
- lightweight yet stable aluminium base plate
- 8 lashing eyes
- simple installation

037-5450





050-6000



050-0884

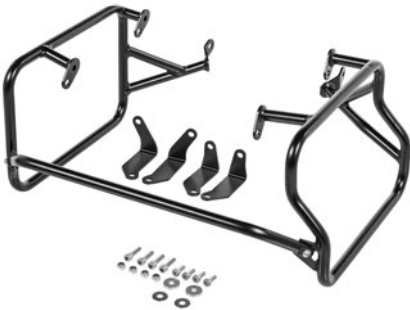

## ZEGA Evo X „Premium Edition“ special system „And-Black“ 45/45 litres with stainless steel rack black

„Premium Edition“ – The all-round carefree package specially designed for the Harley-Davidson Pan America™ 1250

We have put together a pannier system set that barely leaves anything to be desired!

In addition to robust, trail-proof, black stainless steel pannier racks and matching black anodised aluminium panniers, this set also includes two interior luggage pockets made of hard-wearing, dirt-repellent nylon fabric and a matching, keyed alike lock set with six locks.

These panniers with over 85 litres of lockable, water-proof storage space are also just what you need if you're preparing for long journeys to distant regions. The larger of the two panniers, with its 45 litres of volume, offers space for a helmet and gloves. Designed as an „Evo X system“, the „smaller“ pannier is perfectly optimised to enable the pannier system to be positioned as close as possible to the vehicle.





This optimised positioning of the panniers on the pannier rack is much appreciated by passengers. Compared to the original pannier system and most other solutions available on the market, the Touratech pannier system for the Harley Pan America offers pillion passengers significantly more peg foot space. The position of the panniers was designed to promote positive riding characteristics.

The interior pockets (1 x 38 litres and 1 x 45 litres) make it even easier to load and unload the top-loading aluminium panniers. With three zips, these pockets have dual functionality. In the pannier, they can be opened from the top for easy access. But the side can also be fully opened, which makes packing at home noticeably easier.

The „Premium Edition“ is rounded off with the lock set consisting of six keyed alike locks. This means you only need one key to operate all the locks.

A typical feature of the special system is the recess on the right-hand pannier that allows it to nestle snugly against the exhaust. The panniers are positioned closer to the bike's centreline, the overall width is reduced, and the system as a whole appears more balanced thanks to the

symmetrical pannier lids. Made from stainless steel, the sturdy pannier racks are scratch and rust resistant.

Our pannier frames are made of robust 18 mm stainless steel round tube and thus guarantee extremely high stability, even off the beaten tracks. An additional cross-bar provides greater stability which also makes the case system suitable for tough off-road use. As the pannier frame utilises existing mounting points, installation is child's play.

And, of course, we took care to ensure that the pannier frame is as practical for a round the world trip as it is for everyday routine. Which is why we ensured absolute passenger suitability.

#### **Delivery schedule:**

- 1 x ZEGA Evo „And-Black“ 45 liters - left
- 1 x ZEGA Evo X Special „And-Black“ 45 (40,5 l) - right
- 1 x Pannier frames including mounting material
- 1 x ZEGA Evo lock set for 2 cases (050-6000)
- 1 x ZEGA Bag Set 38/45, set of inner bags (050-0884)

**440-0001**



- 1 Handlebar | Cockpit | Windscreens | Lighting from page 322
- 2 Protection from page 329
- 3 Seat from page 337
- 4 Suspension from page 338
- 5 Tank bag from page 341
- 6 Tail rack bag from page 341
- 7 Case systems from page 345



# KTM

**1290 SUPER  
ADVENTURE**

**1190  
ADVENTURE / R**

**1090  
ADVENTURE**

**1050  
ADVENTURE**





### Rear-view mirror Adventure folding M10 x 1.25

Two different basic positions and an adjustment range of 180 degrees with eleven different locking positions cover all eventualities for adjusting the mirror. The rear-view mirror can be folded during off-road travel and during transport to avoid any damage.

- can be set to eleven predefined positions
- can be used left or right
- with ECE certificate
- patented design

Scope of delivery 1 mirror with instructions for installation and adjustment.  
Length 26 cm.

040-0771



### Folding mirror, length adjustable

Universal folding mirror, length and angle continuously adjustable, to suit most motorbikes.

- suitable for use on left or right
- including the appropriate mounting adapter

040-0760



### Safety rear-view mirror set, aspherical, right-hand thread M10 x 1.25

The Safety rear-view mirror is the ideal motorcycle mirror for your Adventure Bike. Thanks to the aspherical part, the visible area is increased - making the „dead angle“ a thing of the past. The ball joint allows for easy adjustment of the rear-view mirror.

A worthwhile safety feature - for city traffic, roads and motorways! A set for both the left and the right side.

Dimensions: Total approx. (h x w) 160 x 260 mm

Glass approx. (h x w) 82 x 140 mm

040-0785



### Raising handlebar 25 mm type, with ABE

KTM 1050 / 1090 / 1190 / 1290

It's often the little things that make all the difference! As is the case with the Touratech handlebar riser for the KTM 1050 ADV / 1090 ADV / 1190 ADV / 1290 Super ADV. Raising the handlebar by 25mm

results in a more upright, much more relaxed seating position. The adjustment range of the handlebar angle is increased, which further increases rider comfort. The Touratech handlebar riser also makes riding while standing less tiring, which is of tremendous benefit to taller riders in particular.

371-5255

### Kaoko Cruise Control mechanical cruise control

KTM 1050 / 1090 / 1190 / 1290 (-2020)

The original by the South African inventor! The Kaoko Cruise Control replaces the original handlebar end weights. The anti-slip knurled screw secures the accelerator in position. This significantly reduces the strain on the right hand during long journeys. Thanks to the continuous adjustment, the accelerator can also be fixed to decelerate very gently - leaving you enough time to take your hand off the handlebar for a moment without immediately losing throttle.

330-0006



### Hand protectors GD

These hand protectors are made of virtually indestructible plastic; they are modern in design, offer a high level of protection, and can easily be fitted to the KTM using the fitting sets (included). The hand protector can be combined with various spoilers and then offers optimum protection against wind and weather.

040-6711 black

040-6715 white

Spoiler

040-7301 black





Defensa EXPEDITION + EXTENSION



372-5660



372-5661

## Hand protectors DEFENSA

Whether off-road riding or touring – the Touratech Defensa offers reliable protection for handlebar fittings and hands, so that a minor mishap does not turn into a major problem. With the Defensa, Touratech has developed an extra-robust protector for handlebar fittings and hands. The construction made of high-strength aircraft aluminium is precisely adapted to your motorbike model. Thanks to the „Defensa System“, the protector offers interesting variation possibilities. Whether you choose a pure protector or a wide protector with an extra spoiler... Defensa hand protectors – for a particularly wide range of uses. The handlebar fittings are among the most vulnerable assemblies on a motorbike. The solid protector reliably protects the levers from damage. The closed protectors have a bracket that is supported near the clamping blocks as well as at the end of the handlebars, thus completely framing the armature. This principle has proven itself in rally motorbikes under the toughest conditions. The system consists of two bolted main components and an attachment kit. There

Defensa EXTENSION, (SPOILER)



is always the required space behind the protector so that the levers can move freely. The annoying hitting, especially of the clutch lever, on the protector, as known from universal products, is a thing of the past with the Defensa. The components of the Defensa are made of a high-strength forged aluminium alloy, as proven in aircraft construction. With a thickness of 14 millimetres, the dimensions have been chosen generously without losing sight of the issue of weight. Precision manufacturing ensures excellent dimensional accuracy and thus a precise fit. The model-specific adaptation ensures tension-free installation and full steering angle.

### Simple adaptation for on- and off-road use

For pure off-road use, it is recommended to use the Defensa „Pure“ version, where only the bar is mounted. For mixed use, there is the Defensa „Expedition“, which is fitted with a plastic wind deflector. The plastic shell is slid over the main hoop and clamped to the screw connection of the two aluminium components, ensuring a precise and secure fit. If you need even more weather protection, you can also fit the separately available „Extension“ spoiler. Of course, the Defensa Expedition can easily be converted back to the Pure.

### Defensa Pure

372-5650 silver

372-5660 black

### Defensa Expedition

372-5651 silver / black

372-5652 silver / white

372-5661 black / black

372-5662 black / white

### Defensa Extension

102-5651 black

102-5652 white



### Touratech brake and clutch lever set, adjustable, folding and length adjustable

The Touratech levers are milled from high-strength aluminum as in aircraft construction from the full. They are 6-way adjustable and hinged. In case of a fall the lever can fold up without breaking it. In normal operation, the levers are protected by a fold-up mechanism.

The levers are adjustable in length by dovetail connection by 35 mm. The anodization meets the highest quality standards. All screw connections comply with the DIN standard and are tightened before delivery with the torque wrench.

The CNC levers are delivered with German ABE (General Operating Permit) and are therefore registration free.

371-5640 KTM 1050 ADV, 1090 ADV

374-5640 KTM 1190 ADV, 1290 S-ADV

### Touratech brake and clutch lever set, adjustable, short version

CNC machined high-tech lever in the short version about 17 cm long and are therefore ideal for the so-called „two-finger brake system“.

High-strength aluminum (material: T6063 T6), which is also used in aircraft construction, milled from solid, weight only about 250 g (both sides).

We use a high quality anodization process which is tested for longevity and corrosion resistance.

The levers are adjustable by means of adjusting lever 6-fold at a distance to the handlebars.

371-5641 KTM 1050 ADV, 1090 ADV

374-5641 KTM 1190 ADV, 1290 S-ADV

Photo: Ely Woody





373-5090



### Headlight protector Makrolon

Not suitable for KTM 1290 Super Adventure S, R, T (2017-)

371-5091 Makrolon orange

371-5090 Makrolon black

Suitable for KTM 1290 Super Adventure S, R, T (2021-)

373-5090

**OFFROAD  
USE ONLY**

371-5091

371-5090



### Mounting kit for headlamp guard with KTM air filter dust cover

KTM 1290 Super ADV S/R (-2020)

With this mounting kit, you can mount your Touratech headlight protection together with the original KTM air filter dust cover.

374-5096



373-5095



### Stainless steel headlight protector with quick release fasteners

The KTM Adventure is an ideal motorbike for exploring the world both on and off-road. Especially on gravel roads, headlights are always at risk of being damaged by stones thrown up by the vehicle in front. Touratech's stainless steel headlight protector effectively prevents larger stones from damaging the headlight lens. The latticework creates a rugged off-road look and considerably modifies the bike's appearance. As well as being a practical product made from laser-cut black stainless steel, it also matches the style of a touring enduro. Another great feature is the quick release fastener that lets you easily clip on the headlight protector

and detach it again as needed. And of course the protector comes with everything you need to fit it. The headlight protector has been developed for off-road use and is not permitted in the scope of German StVO. Please check your national regulations!

**Not suitable for KTM 1290 Super Adventure S/ R/ T (2017-)**

371-5096 Stainless steel orange

371-5095 Stainless steel black

**Suitable for KTM 1290 Super Adventure S/ R**

374-5095 (2017-2020)

375-5095 (2021-)



374-5095

**OFFROAD  
USE ONLY**



371-5095



## Windscreen spoiler Evo, with ABE

Whether you need it for your original windscreen or as accessory to your new Touratech windscreen - with Touratech's windscreen spoiler Evo, you absolutely gain extra comfort on each terrain.

Evo offers the right balance between protection and ventilation - whether you drive on motorways, roads or off-road. Height, inclination and distance to the windscreen can easily be adjusted - you do not need any tools.

If you are going fast and the weather is rainy, fasten the spoiler at its highest level to benefit from an effective wind and weather protection. It is a noticeable relief for your

head and upper body, and wind noises in your helmet are significantly reduced.

If you set the lowest level, the windscreen spoiler almost disappears. This guarantees maximum ventilation when riding off-road.

**040-1380** transparent

**040-1381** tinted

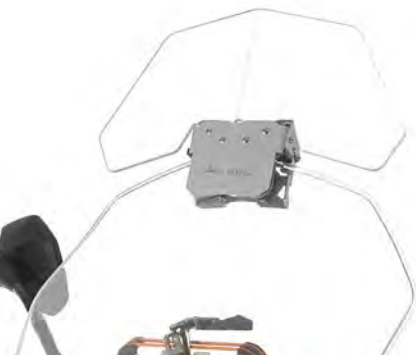

## Spoiler for windscreen „lockable“

**KTM 1050 ADV / 1190 ADV / R**

There is a significant reduction in turbulence and wind pressure against the helmet. It simply fits onto the windscreen, and is secured using the snap closure. When going off-road, the spoiler is easy to remove in seconds. A high quality brand lock secures the spoiler against unauthorised removal. The locks are also available with the same closure as our ZegaCase and GPS bracket locks.

**371-5350**



## GPS mounting adapter above instruments

**KTM 1050 ADV / 1090 ADV / 1190 ADV**

But now, thanks to the GPS mounting adapter, it's easy to mount a GPS securely and ready for use in the cockpit of the Adventure. A strong stainless steel frame is screwed into place directly below the odometer, and will cope with even the toughest vibrations. This frame holds the 12 mm strut on which all Touratech GPS holders can be mounted. The highest possible position is chosen for the strut! You don't have to move your eyes from the route to look at the GPS – nor are the important instruments covered up.

**371-5416** Stainless steel orange

**371-5415** Stainless steel black

**373-5415** 1290 S-ADV (2021-)





371-6202



371-6222



## Windscreen, with ABE

Not satisfied with the original wind shield of your bike? Thanks to countless miles of adventure experience and to the know-how of our production department, we developed a wind shield that unites an appealing adventure design and an optimal function for every application.

Replace your original windscreen with the Touratech wind shield and discover much better driving properties! The form and function of the upper edge of the wind shield is based on our rally experience. The aerodynamic optimization guides the air streams over the head of the pilot without unnecessary turbulences. So, the wind shield is not only flatter-free, it also guarantees a relaxed driving pleasure that doesn't exhaust the pilot nor the pillion passenger.

KTM 1290 (-2016) / 1190 / 1090 / 1050

371-6202 S, tinted

KTM 1050 / 1090 / 1190

371-6220 L, transparent

371-6222 L, tinted

Not suitable for KTM 1290 Super Adventure S, R, T (from 2017)

## Radiator protector

KTM 1290 Super ADV S/R (2021-)

The Touratech radiator protector shields the vulnerable lamellae of the radiator against damage and thus provides an enormous safety benefit!

The dread of flying stones, sticks or other debris will be no more. A small investment will make your trip a whole lot safer!

Optically unobtrusive yet in the unmistakable Touratech-style, the radiator protector made of laser cut aluminium blends in with the 1290 design perfectly.

Colour: black

Parts supplied: 2 parts (left and right)



**Note:** The radiator cover can cause the engine to overheat under extreme conditions with high outside temperatures and an extreme engine load. Please watch your water temperature gauge.

373-5015



## EXPEDITION engine guard

KTM 1290 Super ADV / 1190 Adventure/R /  
1090 Adventure / 1050 Adventure

Professional guard for engine and manifolds. Multiply aligned indentations provide maximum stability on the 4 mm thick aluminium base. A subconstruction distributes the occurring forces with maximum efficiency. This makes the Touratech EXPEDITION engine guard one of the strongest on the market. There is no restriction of ground clearance. Plastic runners on the underside of the base make it easier to „glide“ over stones, rocks or tree stumps. And almost incidentally they also prevent dirt build-up.

1290 Super ADV (-2020)

374-5135

1290 Super ADV (2021-)

373-5140 silver 279,00 €

373-5141 black 279,00 €





## Engine protector RALLYE

KTM 1290 Super ADV (-2020) / 1190 Adventure/R /  
1090 Adventure / 1050 Adventure

With our RALLYE engine protector we combine modern production techniques with a unique design for the best possible protection of the entire engine area of your bike!

The engine protector blends in stylishly with the lines of your motorbike. Thanks to innovative production technology, there are no disturbing welds, which are often considered to be a vulnerable point. The recesses on the underside don't only look good. In the event of the protector having to live up to its name, they provide the shock absorbing and lightweight aluminium with a robust stiffness. And as well as that, the two parallel recesses allow the bike to almost glide over obstacles. In this way, the energy of the impact is effectively dissipated, preventing jamming or snagging.

371-5136 silver

371-5137 black





373-5162



## Crash bar extension

Ideal protection for the fairing on the KTM.

This crash bar extension from Touratech provides optimal protection for the expensive plastic fairing parts. In terms of engineering and design, it integrates perfectly with the original KTM crash bar on the Super Adventure. The crash bar extension makes a lot of sense for all 1290 owners who ride their machine the way it was meant to be ridden.

A new fastening system allows the extension to friction fit onto the original bar. In the event of a crash, the force of the impact is distributed in the best possible way. The tank fairing and not least the tank itself are protected.

The extension is designed to perfectly follow the bike's lines, giving it an individual look.

Material: stainless steel

### 1290 Super ADV (-2020)

374-5160 orange

374-5161 silver

### 1290 Super ADV (2021-)

373-5161 black

373-5162 orange

### KTM 1190 ADV / R 1090 ADV / 1050 ADV

371-5161 orange

371-5162 black



373-5161

## Mudguard riser for original mudguard

The Touratech mudguard riser prevents mud build-up between the tyre and mudguard which could cause the front wheel to lock. The original mudguard is retained in its entirety, but is raised by a critical 15 mm. Generally this is enough to prevent mud clogging between the front wheel and mudguard so you can keep riding even in bad muddy conditions. Not for KTM 1190 Adventure-R and 1290 S-ADV (2021-).

371-5441



## Splash guard under number plate

KTM 1290 Super ADV (-2020) / 1190 Adventure/R / 1090 Adventure / 1050 Adventure

The aerodynamic „knack“, proven 1000 times over, has been further optimised by the side wings. Water and mud splashes are cleverly deflected. No more dirty backs - or dirty luggage. The Touratech splash guard has been specially adapted to the contours of the number plate holder. Beautifully integrated in the vehicle design, it is also suitable for smaller number plates.

371-5000



## Frame guard, left and right

KTM 1290 Super ADV (-2020) / 1190 Adventure/R / 1090 Adventure / 1050 Adventure

An unobtrusive, very good-looking and extremely practical guard for the frame of your new KTM. Everyone knows the problem: your boots scrape against the frame, and gradually damage the surface. Mud and sand can also scratch the frame tubes. Not only does it look unattractive, but it also encourages rust. Our well-fitting frame guard in tough plastic is the perfect solution to this problem. Couldn't be easier to fit - and it blends well with the vehicle's overall appearance.

Set for both sides.

371-5510

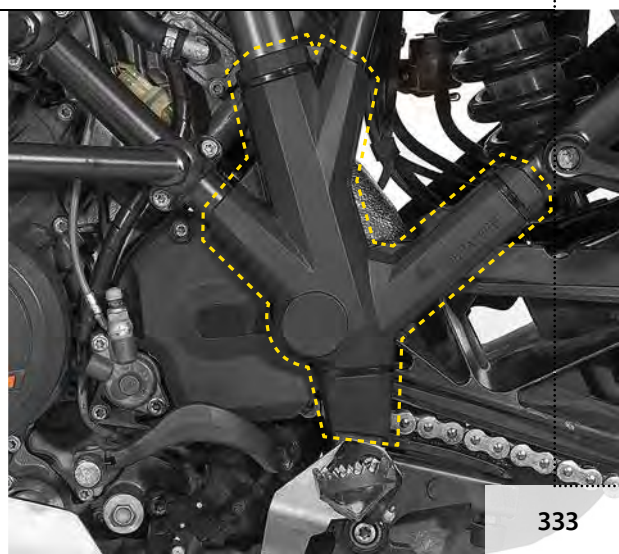



### Chain guard, black anodised

KTM 1290 S-ADV / 1190 ADV / 1090 ADV / 1050 ADV

A core of almost indestructible stainless steel holds the light aluminium cover. Form and function are no longer a contradiction in terms. The combination of these two materials will give your KTM that certain something! The

Touratech chain guard is much stronger than the original plastic one, which makes it much more suitable for a large touring enduro like the Adventure.

371-5045

373-5045 1290 S-ADV (2021-)



### Chain guard fin

KTM 1290 S-ADV / 1190 ADV / 1090 ADV / 1050 ADV

We have developed an efficient lower protection to match our chain guard from the same combination of aluminium/stainless steel. It is particularly effective off-road at preventing branches and other objects from knocking the chain off the drive sprocket.

371-5305

373-5305 1290 S-ADV (2021-)

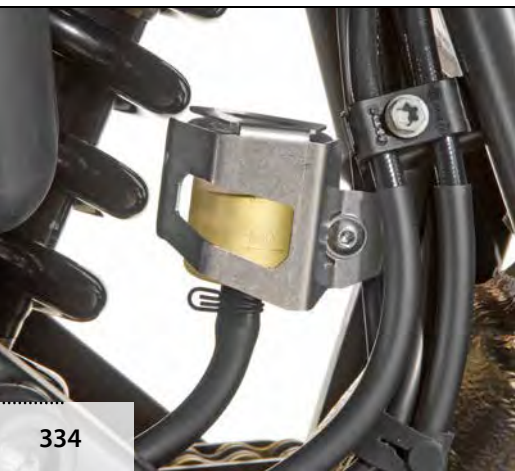

### Rear brake reservoir cover

KTM 1290 S-ADV / 1190 ADV / 1090 ADV / 1050 ADV

This beautiful looking, functional cover is simply screwed onto the existing mounting points. This ensures that it is no longer so easy for anyone to remove the brake fluid reservoir cover.

It is still very easy to read the level in the reservoir.

620-0007

KTM 1290 S-ADV (2021-)

372-5030 orange

372-5031 black

## ABS sensor protection rear

### 1290 Super Adventure

The ABS sensor is very important for safety - and very easily damaged. So it goes without saying that we've developed a protector for this component. Especially on a bike like the KTM that's sure to see a gravel trail every once in a while. And you don't need to tell a seasoned off-roader about the sort of damage flying stones can cause.

Material: 1,5 mm stainless steel

372-5010



## WORKS long-distance foot pegs

with ABE

- 52 mm wide and 4 mm thick stainless steel claw profile that is kind to your boots
- Perfect combination of grip and self-cleaning
- With a more slender design for better ground clearance
- Significantly less susceptible to impacts
- Strengthened mounting point
- With a blasted surface and laser inscription for a superior finish

370-5315



## Pivot Pegz MK 4

Pivot Pegz MK4 now with 6 cm wide and 10 cm long tread for even better grip!

An absolute breakthrough - and not just for cross-country and enduro riders who bemoan the lack of sensitivity of the original pegs. Thanks to a spring joint, these foot pegs follow the forward and backward movements of the foot to an angle of 20 degrees.

040-5523

040-5525 Toppers



040-5525



### Folding brake lever attachment kit

The foot brake lever can easily get bent in rocky terrain. Reason enough for us to replace the surface of the original one with a folding one. The original footrest is dismantled and the folding version fitted in its place.

370-1507



### Stainless steel foot brake pedal extension, standard height

A firm footing on the brake is a basic necessity, especially when riding off-road. This is why the foot brake pedal extension we developed for the KTM is serrated just like our proven \*Works\* long-distance foot pegs. Its surface area is appreciably larger than the original part to make sure your boot never misses the pedal again. The distance from the foot peg can be shortened by 11.5 mm if desired. The height is the same as the original. The extension is made from 2 mm thick electro-polished stainless steel, making it virtually indestructible. Fitting it onto the existing mounting points is simple and straightforward.

371-5390

### Side stand base extension

The side stand base extension more than doubles the area of the supporting surface, so you won't find yourself straining to lift the fully loaded machine. A mix of stainless steel and black anodised aluminium components ensure the base extension looks good and provide full stability. Securely fixed to the side stand, the base extension is a useful accessory that is always there to save you a lot of hassle and frustration.

371-5275 1190 (2013)

371-5276 1050, 1090, 1190 (2014-), 1290 (-2020)

373-5275 1290 S-ADV R (2021-)

373-5276 1290 S-ADV S (2021-)



373-5276



371-5275





## Comfort seat rider

Even with KTM's touring bikes, being "ready to race" was right at the top of the development list. So it's no wonder that we found a number of points on the standard seat that needed to be changed in order to noticeably improve rider and passenger comfort on long journeys. Our seats are made from a special foam in a comfortable mix and our own

resilient plastic tray, and will increase the long-distance comfort of even the sportiest touring enduro to the maximum. The single seats will also fit the Adventure „R" version, where they are also an excellent alternative to the original one-piece sports seat.

## Sports seat, one piece

Continuous or single seats - we give you the choice! A slightly more comfortable one-piece seat certainly won't do the Adventure R any harm! Because even on this bike, a long journey should be a pleasure, not torture. So we also offer the one-piece seat with various improvements such as optimised foam and a different contour as a comfortable long-distance alternative to the less comfortable standard seats.



371-5963

### Comfort seat \*Fresh Touch\*

371-5950 Low	371-5951 Standard	371-5952 High	371-5957 Pillion
--------------	-------------------	---------------	------------------

### Sports seat \*Fresh Touch\*

371-5962 Low	371-5963 Standard	371-5964 High
--------------	-------------------	---------------

### Sports seat \*Fresh Touch\* 1290 S-ADV (2021-)

373-5962 Low	373-5963 Standard	373-5964 High
--------------	-------------------	---------------

### Sports seat breathable

	371-5916 Standard	371-5917 High
--	-------------------	---------------



## Touratech Suspension Steering Damper „Constant Safety Control“

KTM 1090 ADV R / 1190 ADV / 1190 ADV R / 1290 ADV / 1290 ADV R

The Touratech Suspension „CSC“ steering damper is developed specifically for the KTM and adjustable. The riding stability of your KTM is optimised effectively and can be individually fine adjusted via 24 clicks. Whether on tour with a full

load or chasing through bends, you are always en route with your personal setup. The original KTM steering damper is not adjustable. We have found out that the linear Touratech Suspension „CSC“ (Constant Safety Control) steering damper, with its permanent supporting effect, allows for completely new riding experiences.

**371-5830**

Not suitable for KTM 1050 ADV / 1090 ADV!



## Progressive fork springs

KTM 1050 ADV / 1090 ADV / 1190 ADV / 1290 Super ADV / R

**371-5836** KTM 1190 Adventure (2013-) without EDS

**371-5838** KTM 1190 Adventure R (2013-) without EDS

**371-5842** KTM 1190 Adventure (2013-) with EDS

**371-5832** KTM 1050 Adventure (2015-)

**371-5845** KTM 1090 Adventure R (2017-2019)

**371-5834** KTM 1090 Adventure (2017-2018)

**371-5847** KTM 1290 Super Adventure R (2017-2020)



## Progressive replacement springs for fork and shock absorber

KTM 1050 Adventure / 1090 Adventure / 1190 Adventure / R

**371-5837** KTM 1190 Adventure (2013-) without EDS

**371-5839** KTM 1190 Adventure R (2013-) without EDS

**371-5843** KTM 1190 Adventure (2013-) with EDS

**371-5833** KTM 1050 Adventure (2015-)

**371-5835** KTM 1090 Adventure (2017-2018)

**371-5846** KTM 1090 Adventure R (2017-2019)

**371-5848** KTM 1290 Super Adventure R (2017-2020)



# TOURATECH SUSPENSION

## Touratech Suspension Cartridge Kit EXTREME

Putting it simply, the Touratech Suspension Cartridge Kit Extreme is a suspension strut for the fork and the absolute top end in terms of suspension technology. The Closed Cartridge is installed into the original fork. This way the fork bridge/handlebar mount, brakes and wheel control and handlebar geometry are retained in full. No additional modifications to the fork are required.

This Closed Cartridge has been developed perfectly for touring and riding with frequently and strongly differing loads and riding conditions or extreme requirements.

**371-5840** KTM 1190 Adventure R (2014-)

**371-5841** KTM 1050 ADV (2015-) / 1090 ADV (2015-)

**371-5844** KTM 1090 ADV R (2017-) / 1290 S ADV (2018-)



## Touratech Suspension shock absorber Type EXTREME

**KTM 1050 Adventure (2015-) / 1090 ADV (2015-)**

The Touratech Suspension Extreme shock absorber ranks in the absolute premium class of suspension components. This Extreme shock absorber for the KTM 1050 Adventure is perfectly suited to touring and riding with frequent dramatic changes in loading and riding conditions, and the most extreme demands. The Extreme shock absorber is fitted with a position sensitive damping system (PDS), which utilises a second damping piston to provide hydraulic protection against bottoming out. Even fully loaded with luggage under the most extreme off-road conditions, the bike will not bottom out and the shock absorber is protected against mechanical overload. Damping characteristics change depending on the road surface. When riding under most conditions, the shock absorber is comfortably adjusted for a less strenuous ride, before the PDS kicks in for the last portion of the shock absorber stroke.

**371-5865**





## Touratech Suspension shock absorber EXTREME

KTM 1290 S-ADV R / 1190 ADV R / 1090 ADV R

The Touratech Suspension Extreme shock absorber ranks in the absolute premium class of suspension components. This Extreme shock absorber for the KTM is perfectly suited to touring and riding with frequent dramatic changes in loading and riding conditions, and the most extreme demands. The Extreme shock absorber is fitted with a position sensitive damping system (PDS), which utilises a second damping piston to provide hydraulic protection against bottoming out. Even fully loaded with luggage under the most extreme off-road conditions, the bike will not bottom out and the shock absorber is protected against mechanical overload. Damping characteristics change depending on the road surface. When riding under most conditions, the shock absorber is comfortably adjusted for a less strenuous ride, before the PDS kicks in for the last portion of the shock absorber stroke.

Facts at a glance:

- This shock absorber is configured and adjusted ready for use based on our experience with the KTM Adventure R.
- The parameters are: vehicle weight; shock absorber pivot point; design constraints; test rides.
- This shock absorber is designed for a rider's weight including luggage of up to 100 kg.
- As with all suspension solutions, the rear and front of the motorbike should be modified together.

Detailed information on Touratech Suspension and available variants can be found starting on page 596!

371-5871

 **TOURATECH**  
SUSPENSION



## Tank bag IBARRA

KTM 1290 S-ADV / 1190 ADV / 1090 ADV / 1050 ADV

The „Ibarra“ tank bag has been specially designed for big trail bikes and large space requirements. The upper material is water-repellent and abrasion-resistant. With its large main compartment, two zipped outer pockets and detachable map pocket in DIN A4 size, the Ibarra offers enough volume even on long tours. The expansion zip allows for additional storage space. Like all Touratech tank bags, the Ibarra can also be fitted or removed in seconds with click fasteners. Elasticated straps with quick-release fasteners, YKK brand zips and reflective sections by 3M round off these high-quality features.

Dimensions: (L x W x H) approx. 35 x 26 x 18/25 cm;

Volume: approx. 14/22 litres.

055-1281



## Tank bag AMBATO Exp

As we develop and offer the exclusive base plates and strong attachment kits for our robust tank bags for each specific vehicle, it is a given that a perfect fit with no play at all should be achieved! The Ambato Exp is also notable for the expansion option with an all-round zipper; small items can easily be stored under the adjustable elastic strap on the back. Thanks to the water-repellent cable hole, it's now easy to charge a mobile phone in the tank bag - plus the side pockets have an expansion pleat, which means there's even more room inside them than you would think.

Size: (L x W x H) approx. 37 x 27 x 22/32 cm;

Volume: approx. 13/18 litres

371-5825



## Pillion seat bag AMBATO Exp

The perfect solution for more luggage: „Ambato Exp“! With two outer pockets, a large main compartment, the elastic drawstring on the top, the all-round zipper for when you want to increase its size and the practical carrying handle, this pillion bag can cope with any challenge! Comes with two carrying handles so it can be used as a backpack or shoulder bag, and with a water-repellent cable hole on the inside, tasks such as charging electrical devices are not a problem. And that's just a couple of the many options offered by this pillion bag!

Size: (L x W x H) approx. 33 x 30 x 20/32 cm;

Volume: approx. 17/22 litres;

Colour: black.

055-1282





### Pillion seat bag AMBATO Pure

If you're looking for a high-quality, sturdy and rugged pillion bag that takes up the least amount of space, doesn't get in the rider's way,

is easy to mount and also offers some nice, practical features, then this is the right one for you.

Size: (L x W x H) approx. 33 x 30 x 15 cm;  
Volume: approx. 12 litres; Colour: black

055-1283

### Pannier AMBATO for the luggage rack

KTM 1290 S-ADV / 1190 ADV/R

There is plenty of room on the original luggage rack for a strong, practical bag. It is perfect for storing waterproofs, spare gloves, tools and small amounts of shopping safely and out of the weather. Of course, this in no way impairs the passenger's comfort, and because the back is far back on the vehicle, the rider is still able to get on with ease. The pannier slides onto the luggage rack from the back, is secured at the front with two straps and the special base plate ensures that it remains safely in place. Size: (L x W x H) approx. 30 x 30 x 19 cm; Volume: approx. 13 litres; Colour: black.

371-5811

### Aluminium/stainless steel luggage rack

The Touratech luggage rack for the KTM has an appealing and unusual two-component design. A cover plate made of lightweight aluminium is riveted to a base plate made of rugged stainless steel. The numerous cut-out areas allow luggage of any shape to be securely tied to your bike. The luggage rack is additionally supported by a subframe. This increases its stability, reduces vibrations and results in greater transportation capacity. Installing the rack slightly higher makes it considerably easier to pass straps through.

371-5450 KTM 1290 S-ADV (-2020)

373-5450 KTM 1290 S-ADV (2021-)



## Handlebar bag IBARRA

Practical storage space exactly where you need it! The sturdy handlebar provides enough space to attach an extremely practical and travel-worthy bag. A wide opening water-repellent dustproof zip provides easy access to a large main compartment in which the things you need quickly - a first aid kit, spare pair of gloves, breakdown kit or also your travel documents, wallet, sunglasses and mobile phone - are well protected. A key feature is that our bag doesn't in any way restrict the rider's movements or affect control of the bike.

045-5827



## Touratech KTM motorcycle toolset, 68 PCS

The professional tools for your KTM motorcycle. A lot of great ideas and many impressive patent tools have been put into this one to ensure that we are always innovating for the better. The dream set for your road trips and any repair works you encounter.

All the tools are made with the best quality materials, S2 Bits with Black Phosphate finishing anti-rust. Cr-V Satin Chrome Plated sockets and spanners.

MIT (Metric/Inch/Torx): The MIT print work on various type of nuts: Square, 6 or 12 points, Star, Spline and damaged.

070-2212



Air box dust seal

Snorckel pre-cleaners



Main filter



## Unifilter

KTM 1290 Super Adventure / S, R, T (2017–2020) /  
1190 Adventure / 1190 Adventure/R /  
1090 Adventure / 1050 Adventure

On many of our trips in dusty and dry countries and on many sporting events and rallies we had the problem that fine dust kept on getting through the air filter and into the intake system. Sometimes with serious consequences for the engine. We have tried and tested a large number of air filters over the last few years. We found the solution to our dust problem in Australia. Unifilter Australia gave us an air filter to test that fully met our expectations. The Touratech Research & Development team used the Unifilter and since then have found no dust residue in the air filter box. Another advantage of the filter, made of high-tech foam, is the long service life. The filter is not thrown away when it's dirty but rinsed out, lubricated again and used time and time again. So you don't just take care of your engine but also your wallet. In our opinion it's an absolute must for off-road motorbikes! Made in Australia.

Scope of delivery:

1 x Main filter, 1 x spare set of foam inserts, 1 x air box dust seal

371-0872 Snorckel pre-cleaners only

371-0873 Air box dust seal only

371-5875



## Replacement Filter Set for KTM air filter dust cover

KTM 1290 Super ADV S/R (–2020)

371-0874





## Scottoiler vSystem chain lubrication system

The Scottoiler vSystem is a vacuum-controlled chain lubrication system which lubricates the chain while you are riding your motorbike - completely automatically. The system only works when the engine is running. Depending on the drop rate set, it releases 1-2 drops of oil per minute. This improves the performance of the chain, keeping it clean and flexible for up to 12,500 km. Chain wear is significantly reduced. Cleaning and lubrication is no longer necessary. The Scottoiler is the end of uncared-for motorbike chains - and for hands sticky with chain spray. The KTM Edition includes special parts for installation. The colour enables the motorbike to be customised and the kit to be installed discreetly.

030-0177



KTM 1290 | 1190 | 1090 | 1050

## Topcase rack ZEGA Evo/Pro

Made entirely of stainless steel, the Topcase rack is the perfect way to attach ZEGA Evo / Pro Topcases to your bike.

To achieve optimum stability, the rack for the KTMs is additionally supported on a subframe. This allows the Topcase to be positioned without getting in the pillion passenger's way, reduces vibrations and results in improved safety. You will find the available Topcases on page 472.

KTM 1290 S-ADV (-2020) / 1190 ADV / 1090 ADV / 1050 ADV

371-5455

371-5456 black

KTM 1290 S-ADV (2021-)

373-5454

373-5455 black

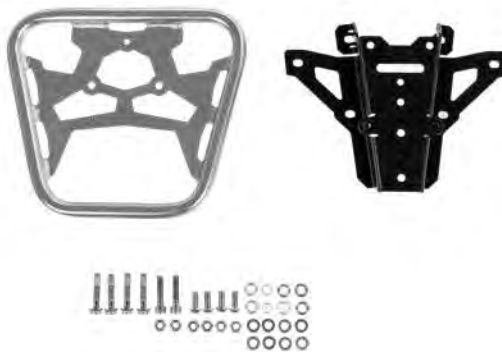

## Pannier Rack

The robust pannier rack is made from 18 mm steel tubing and is black powder-coated or stainless steel. Using special fixing clips, the pannier rack is attached to the rack tail and existing mounting points. Very robust construction with crosspiece which also copes with tough off-road tours and yet elegantly matches the overall appearance of the KTM.

KTM 1290 S-ADV (-2020) / 1190 ADV / 1090 ADV / 1050 ADV

371-5555

371-5560 black

KTM 1290 S-ADV (2021-)

373-5555

373-5560 black

373-5560





## Toolbox for ZEGA Evo pannier systems

### KTM 1290 Super Adventure (2021-)

The Touratech tool box is the ideal solution for the safe storage of small items on your Super Adventure. The optimal utilisation of space on the vehicle allows tools, first-aid kit, breakdown kit and many other useful items to remain on the motorcycle permanently and without interfering. They are always readily accessible, even when the cases are not mounted.

The approx. 4.2 litre large storage space is protected against spray water and a large opening makes loading and unloading easy, even when the cases are mounted. The lid can be removed completely for easier loading, a safety mechanism prevents loss.

The toolbox matches the KTM in materials and design. The perfect combination of stainless steel and plastic provides optimal stability and a look that is difficult to beat. Even if the cases are not mounted, it is an absolute eye-catcher!

Info: if you require a certain key number, please use item 01-050-0870-0 and enter the quantity required.

Using special clamps, the box can be mounted to the case carrier easily and very quickly. A protection cap on the lock against spray water provides permanent ease of use.

Quality „Made in Germany“

- especially for ZEGA Evo pannier systems
- lockable and resistant
- important small items are always readily accessible
- optimal utilisation of space on the vehicle
- protected against spray water

Dimensions: 33 x 9.5 x 19.5 cm

Volume: 4.2 liters

Material: plastic, stainless steel

**045-5614**

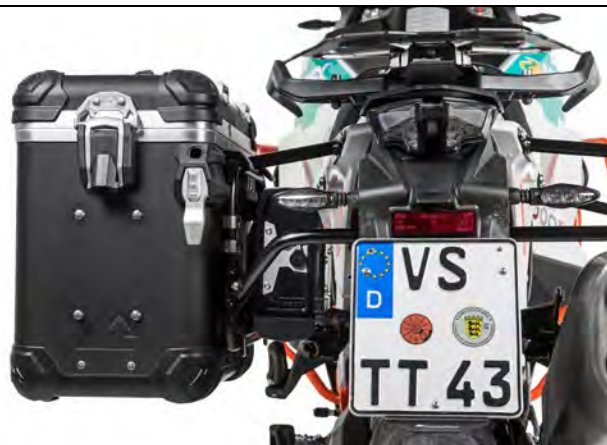



### Aluminium Pannier System

The aluminium pannier system again has a very robust construction. We have tried to bring the pannier racks and the panniers as close as possible to the motorcycle. Numerous tests have already been performed in order to ensure that the entire development satisfies the required demands. The rack is made of 18 mm steel tubing and is attached to existing mounting points using special fixing clips and reinforcing pieces. Pillion comfort not restricted in any way. Enhances the enduro and touring!

## ZEGA PRO ZEGA MUNDO

ZEGA MUNDO

ZEGA PRO

ZEGA EVO



More information  
about ZEGA cases  
from page

>436



# ZEGA PRO

# ZEGA MUNDO



### KTM 1290 Super Adventure (2021-)

	stainless steel	black
ZEGA Mundo 31/38 L	373-6130	
ZEGA Pro 31/38 L	373-5730	373-5780
ZEGA Pro And-S 31/38 L	373-5731	373-5781
ZEGA Pro And-Black 31/38 Liter	373-5732	373-5782
ZEGA Mundo 38/45 L	373-6135	
ZEGA Pro 38/45 L	373-5735	373-5785
ZEGA Pro And-S 38/45 L	373-5736	373-5786
ZEGA Pro And-Black 38/45 L	373-5737	373-5787

### KTM 1290 S-ADV / (-2020) / 1190 ADV / 1090 ADV / 1050 ADV

	stainless steel	black
ZEGA Mundo 31/38 L	371-6130	
ZEGA Pro 31/38 L	371-5730	371-5780
ZEGA Pro And-S 31/38 L	371-5731	371-5781
ZEGA Pro And-Black 31/38 Liter	371-5732	371-5782
ZEGA Mundo 38/45 L	371-6135	
ZEGA Pro 38/45 L	371-5735	371-5785
ZEGA Pro And-S 38/45 L	371-5736	371-5786
ZEGA Pro And-Black 38/45 L	371-5737	371-5787

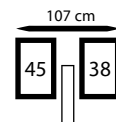
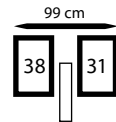



# ZEGA EVO



373-6831



373-6832



373-6836





# ZEGA EVO



## Aluminium pannier system ZEGA Evo with stainless steel rack

The ZEGA Evo, like all Touratech panniers before it, was not developed as an isolated product but was intended from the outset to be part of a luggage system. The outstanding practical benefits are the result of the unique combination of an elegant and indestructible pannier, an ingenious fastening mechanism and a terrain-immune rack made of 18 mm thick stainless steel tubes. Matching inner pannier bags and practical accessory holders round off the luggage system.

- Newly designed plastic corners - protect driver and pannier in the event of an accident
- Proven fixing pins - for ZEGA Evo accessory holder

- Proven handle - for comfortable carrying
- Newly developed fastening system - for easy mounting and secure hold on the pannier rack
- Newly developed lockable one-hand locking system - for convenient and secure attachment to the pannier rack
- Newly developed lockable lid catch- for convenient opening and closing from both sides, thanks to practical hinge function
- Proven silicone seal - for a pannier that's dry on the inside, even in the pouring rain
- Proven attachment eyes - for secure fastening of pannier lid bags and other soft luggage
- Standard hooks on the inside of the lid - for attaching accessories (bags, nets)

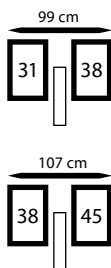

## ZEGA EVO

### KTM 1290 Super Adventure (2021-)

Pannier System with	stainless steel rack	stainless steel rack black
ZEGA Evo AND-S 31/38 litres	373-6831	373-6881
ZEGA Evo AND-Black 31/38 litres	373-6832	373-6882
Pannier System with	stainless steel rack	stainless steel rack black
ZEGA Evo AND-S 38/45 litres	373-6836	373-6886
ZEGA Evo AND-Black 38/45 litres	373-6837	373-6887

### KTM 1290 S-ADV (-2020) / 1190 ADV / 1090 ADV / 1050 ADV

Pannier System with	stainless steel rack	stainless steel rack black
ZEGA Evo AND-S 31/38 litres	371-6831	371-6881
ZEGA Evo AND-Black 31/38 litres	371-6832	371-6882
Pannier System with	stainless steel rack	stainless steel rack black
ZEGA Evo AND-S 38/45 litres	371-6836	371-6886
ZEGA Evo AND-Black 38/45 litres	371-6837	371-6887



# ZEGA EVO X

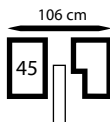
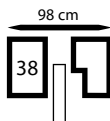

## ZEGA Evo X special systems

KTM 1290 S-ADV / 1190 ADV / 1090 ADV / 1050 ADV

The ZEGA Evo, like all Touratech panniers before it, was not developed as an isolated product but was intended from the outset to be part of a luggage system. The outstanding practical benefits are the result of the unique combination of an elegant and indestructible pannier, an ingenious fastening

mechanism and a terrain-immune rack made of 18 mm thick stainless steel tubes.

A typical feature of the special system is the recess on the right-hand pannier that allows it to nestle snugly against the exhaust. The panniers are positioned closer to the bike's centreline, the overall width is reduced, and the system as a whole appears more balanced thanks to the symmetrical pannier lids. Made from stainless steel, the sturdy pannier racks are scratch and rust resistant.

## KTM 1290 Super Adventure (2021-)

Special System with:	stainless steel rack	stainless steel rack black
ZEGA Evo AND-S 38/38 litres	<b>373-6816</b>	<b>373-6866</b>
ZEGA Evo AND-Black 38/38 litres	<b>373-6817</b>	<b>373-6867</b>
Special System with:	stainless steel rack	stainless steel rack black
ZEGA Evo AND-S 45/45 litres	<b>373-6826</b>	<b>373-6876</b>
ZEGA Evo AND-Black 45/45 litres	<b>373-6827</b>	<b>373-6877</b>



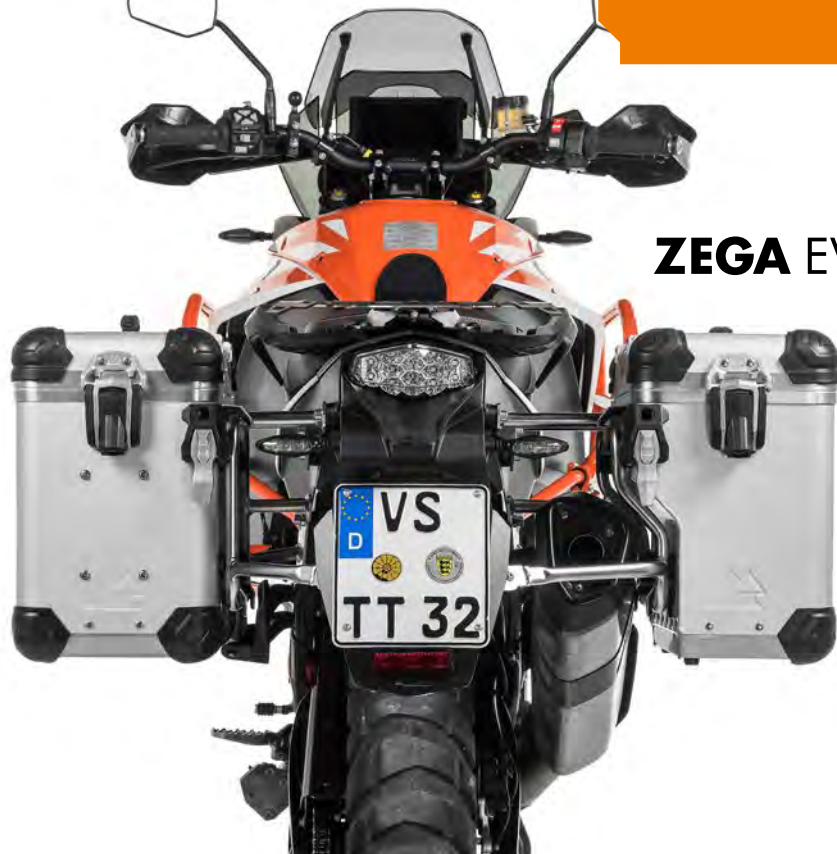

# ZEGA EVO X

KTM 1290 S-ADV (-2020) / 1190 ADV / 1090 ADV / 1050 ADV

Special System with:	stainless steel rack	stainless steel rack black
ZEGA Evo AND-S 38/38 litres	371-6816	371-6866
ZEGA Evo AND-Black 38/38 litres	371-6817	371-6867

Special System with:	stainless steel rack	stainless steel rack black
ZEGA Evo AND-S 45/45 litres	371-6826	371-6876
ZEGA Evo AND-Black 45/45 litres	371-6827	371-6877





NEW IDEAS FOR MOTORBIKES

**TOURATECH**



- 1 Handlebar | Cockpit | Windscreens | Lighting from p. 356
- 2 Engine guard | Cylinder protection | Fairing from p. 360
- 3 Foot pegs from p. 367
- 4 Suspension from p. 368
- 5 Tank bags from p. 371
- 6 Tail rack bags from p. 372
- 7 Pannier systems from p. 376



# KTM

890 ADV / R

790 ADV / R





### GPS mounting adapter above instruments

KTM 890 ADV / 890 ADV R / 790 ADV / 790 ADV R

Our „mounting adapter above instruments“ lets you keep your GPS device or road book firmly in view. No more looking down or distractions to the side - your eyes are always pointed at the road.

372-5415



### Handlebar riser, with ABE

KTM 890 ADV / 890 ADV R / 790 ADV / 790 ADV R

Raising the handlebar by 25 mm results in a more upright, much more relaxed seating position. The adjustment range of the handlebar angle is increased, which further increases rider comfort. The Touratech handlebar riser also makes riding while standing less tiring, which is of tremendous benefit to taller riders in particular.

372-5255 25 mm

### Headlamp guard with quick release fastener

KTM 890 ADV / 890 ADV R / 790 ADV / 790 ADV R

Touratech's headlight protector effectively prevents larger stones from damaging the headlight lens. Another great feature is the quick release fastener that lets you easily clip on the headlight protector and detach it again as needed.

The headlight protector has been developed for off-road use and is not permitted in the scope of German StVO. Please check your national regulations!

372-5095



**OFFROAD  
USE ONLY**



### Touratech brake and clutch lever set, adjustable, folding and length adjustable

KTM 890 ADV / 890 ADV R / 790 ADV / 790 ADV R

The Touratech levers are milled from high-strength aluminum as in aircraft construction from the full. They are 6-way adjustable and hinged. In case of a fall the lever can fold up without breaking it. In normal operation, the levers are protected by a fold-up mechanism.

The levers are adjustable in length by dovetail connection by 35mm. The anodization meets the highest quality standards. All screw connections comply with the DIN standard and are tightened before delivery with the torque wrench. The CNC levers are delivered with German ABE (General Operating Permit) and are therefore registration free.

Not suitable in combination with original KTM heated grips.

372-5640



### Touratech brake and clutch lever set, adjustable, short version

KTM 890 ADV / 890 ADV R / 790 ADV / 790 ADV R

CNC machined high-tech lever in the short version about 17cm long and are therefore ideal for the so-called „two-finger brake system“.

High-strength aluminum (material: T6063 T6), which is also used in aircraft construction, milled from solid, weight only about 250 g (both sides).

We use a high quality anodization process which is tested for longevity and corrosion resistance.

The levers are adjustable by means of adjusting lever 6-fold at a distance to the handlebars.

Not suitable in combination with original KTM heated grips.

372-5641



### Windshield MRA touring windscreen (TN)

KTM 890 ADV / 890 ADV R / 790 ADV / 790 ADV R

The MRA touring windscreen (TN) is 11 cm longer than the sports windscreen. Behind it, the rider is protected from wind pressure and loud turbulence. The windshield is colourless.

Length in mm: 420 Width in mm: 400

- with ABE

Not mountable in combination with a handlebar riser and the GPS handlebar bracket above the instruments (372-5415).

372-0880



Defensa EXPEDITION +  
EXTENSION

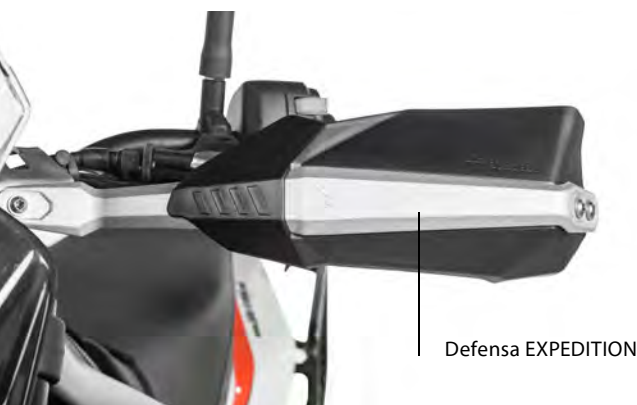

Defensa EXPEDITION

## Hand protectors DEFENSA

KTM 890 ADV / 890 ADV R / 790 ADV / 790 ADV R

Whether off-road riding or touring – the Touratech Defensa offers reliable protection for handlebar fittings and hands, so that a minor mishap does not turn into a major problem. With the Defensa, Touratech has developed an extra-robust protector for handlebar fittings and hands. The construction made of high-strength aircraft aluminium is precisely adapted to your motorbike model. Thanks to the „Defensa System“, the protector offers interesting variation possibilities. Whether you choose a pure pro-

jector or a wide protector with an extra spoiler... Defensa hand protectors – for a particularly wide range of uses. The handlebar fittings are among the most vulnerable assemblies on a motorbike. The solid protector reliably protects the levers from damage. The closed protectors have a bracket that is supported near the clamping blocks as well as at the end of the handlebars, thus completely framing the armature. This principle has proven itself in rally motorbikes under the toughest conditions. The system consists of two bolted main components and an attachment kit. There is always the required space behind the protector so that the levers can move freely. The annoying hitting, especially of the clutch lever, on the protector, as known from universal products, is a thing of the past with the Defensa. The components of the Defensa are made of a high-strength forged aluminium alloy, as proven in aircraft construction. With a thickness of 14 millimetres, the dimensions have been chosen generously without losing sight of the issue of weight. Precision manufacturing ensures excellent dimensional accuracy and thus a precise fit. The model-specific adaptation ensures tension-free installation and full steering angle.

### Simple adaptation for on- and off-road use

For pure off-road use, it is recommended to use the Defensa „Pure“ version, where only the bar is mounted. For mixed use, there is the Defensa „Expedition“, which is fitted with a plastic wind deflector. The plastic shell is slid over the main hoop and clamped to the screw connection of the two aluminium components, ensuring a precise and secure fit. If you need even more weather protection, you can also fit the separately available „Extension“ spoiler. Of course, the Defensa Expedition can easily be converted back to the Pure.



102-5651



102-5652



372-5660



372-5661



372-5650

#### Defensa Pure

372-5650 silver

372-5660 black

#### Defensa Expedition

372-5651 silver / black

372-5652 silver / white

372-5661 black / black

372-5662 black / white

#### Defensa Extension

102-5651 black

102-5652 white

## Hand protectors GD

KTM 890 ADV / 890 ADV R / 790 ADV / 790 ADV R

These hand protectors are made of virtually indestructible plastic; they are modern in design, offer a high level of protection and can easily be fitted to the KTM using the fitting sets (included). The hand protector can be combined with various spoilers and then offers optimum protection against wind and weather.

040-6711 black

040-6715 white

#### Spoiler

040-7301 black





### ABS sensor protection rear

KTM 890 ADV / 890 ADV R / 790 ADV / 790 ADV R

The ABS sensor is very important for safety - and very easily damaged. So it goes without saying that we've developed a protector for this component. Especially on a bike like the KTM that's sure to see a gravel trail every once in a while. And you don't need to tell a seasoned off-roader about the sort of damage flying stones can cause.

Material: 1,5 mm stainless steel

372-5010



### Side stand switch protector

KTM 890 ADV / 890 ADV R / 790 ADV / 790 ADV R

The side stand switch often goes completely unnoticed.

It's only when it stops working and the bike keeps refusing to start that you realise just how important this component is. So we've made a stainless steel protector for the side stand switch.

372-5105



### Rear brake reservoir cover

KTM 890 ADV / 890 ADV R / 790 ADV / 790 ADV R

This beautiful looking, functional cover is simply screwed onto the existing mounting points. This ensures that it is no longer so easy for anyone to remove the brake fluid reservoir cover. It is still very easy to read the level in the reservoir.

372-5030 orange

372-5031 black



## Brake cylinder guard

KTM 890 ADV / 890 ADV R / 790 ADV / 790 ADV R

The rear brake cylinder of the KTM 790/890 Adventure is covered and protected by a plastic part. In offroad use, the original part can be heavily scratched or even break off, due to a stone chip. The Touratech brake cylinder guard has a larger surface, and covers the entire brake

cylinder, including the connection of the brake line, completely. This weak point is thus effectively protected. In addition, the black anodized aluminium gives the motorcycle a perfect off-road look. Our extremely durable brake cylinder cover made out of 3 mm aluminium protects the brake cylinder and your boots.

372-5525



## Side stand base extension

KTM 890 ADV / 890 ADV R / 790 ADV / 790 ADV R

The side stand base extension more than doubles the area of the supporting surface, so you won't find yourself straining to lift the fully loaded machine.

372-5275 ADV R

372-5277 ADV



## Splash guard under number plate

KTM 890 ADV / 890 ADV R / 790 ADV / 790 ADV R

For more than 10 years, Touratech splash guards have been watching the backs of riders and passengers, keeping them dry and clean. And protecting number plates from shaking loose. However, no matter how simple or good the product, development never stops. The aerodynamic „knack“, proven 1000 times over, has been further optimised by the side wings. Water and mud splashes are cleverly deflected. No more dirty backs - or dirty luggage. The Touratech splash guard for the KTM has been specially adapted to the contours of the number plate holder. Beautifully integrated in the vehicle design, it is also suitable for smaller number plates.

- made of black anodised aluminium
- effective protection against splashes
- also reinforces the number plate

372-5000

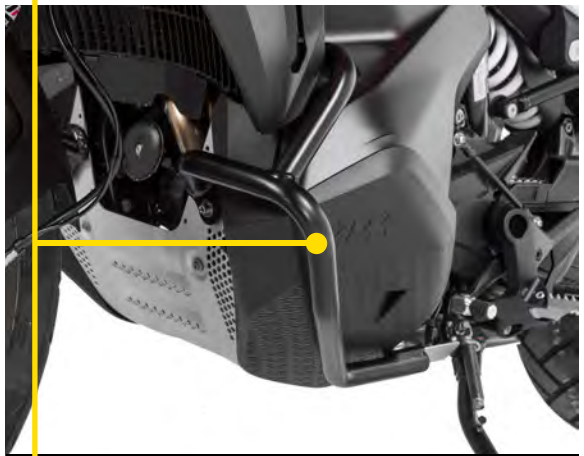

## Tank crash bar stainless steel

KTM 890 ADV / 890 ADV R / 790 ADV / 790 ADV R

Touratech crash bars provide security, in particular, when you are on an off-road adventure trip. Even when the bike only falls over, it prevents the tank from touching the ground. Forces are effectively diverted, and you won't notice even a scratch on the plastic parts of your KTM.

It's up to you whether you choose the black, orange or electropolished crash bar!

372-5155 electropolished

372-5156 black

372-5157 orange

## Stainless steel fairing crash bar

KTM 890 ADV / 890 ADV R / 790 ADV / 790 ADV R

The two-part Touratech fairing crash bar fits as closely as possible to the 790/890 Adventure thus adapting the innovative, sportive design of the KTM. The special construction guarantees optimum diversion of forces and protects cooler and fairing against damage when the bike falls over or in case of a crash. Forces are effectively distributed, and plastic parts of your KTM do not even touch the ground.

The fairing crash bar for 790/890 Adventure may be used with or without the Touratech engine crash bar. It is available in black, orange and electropolished - just as the fairing crash bar. You decide which colour combination you like best with your KTM!

372-5160 electropolished

372-5161 black

372-5162 orange

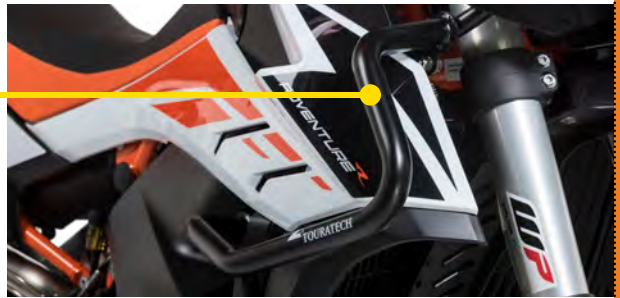



## Engine protector RALLYE Evo

KTM 890 ADV / 890 ADV R / 790 ADV / 790 ADV R

With the 790/890 KTM has brought racing DNA to the road. However, the original engine and tank protection is more of an optical rounding off than any real protection. This prompted a comprehensive requirement profile for our engine guard „RALLYE Evo“. It must be „rock-solid“, look good and should in no way restrict freedom of movement or put unnecessary weight on the vehicle. RALLYE Evo - Probably the most robust engine guard in the world! 20 years of experience in the production of tens of thousands of engine guards flowed into the design and the optimal dimensioning of the materials. The knowledge gained from years of use of our engine guards, as well as the feedback from our customers on previous generations of engine guards, has been taken into account in the new RALLYE Evo engine guard. The result is a clever 3-part construction. This simplifies mounting and saves unnecessary additional weight. The resulting full 360° protection ensures that even in the toughest off-road conditions the engine, the exhaust system and the critical areas of the tank are protected. Flying stones and ground contact can do very little damage to your KTM. The 3-part construction is leveraged through the use of two specially manufactured aluminum alloys. Each one is specially optimised for its particular application. But they do have one thing in common - both are 4 mm thick. The special structure of the extended base

plate, together with the high-strength material, ensures maximum rigidity right up to the catalytic converter. Even in tough off-road use, it protects both the engine and exhaust system. Flat leading chamfers make it easier to overcome obstacles of any kind, whether tree trunk or kerb. Professional robot welding using high-quality tools ensures consistent quality. The two separately mounted tank protection plates are hydroformed for a perfect fit. In addition to the widely projecting lower parts of the tank, they also protect the fuel pump and the fuel taps, like the shell protecting a tortoise. The large cooling opening for improved engine cooling is the same, but can be protected from flying stones with the optional grids (372-5016) if required. Attachment to suitable points on the vehicle is easy. A stainless steel reinforcement in the rear part provides additional lateral support. There are therefore no restrictions to using the Rallye engine protection system with most available centre stands.

The parallel use of Touratech crash bars is also problem-free.

There is no restriction to ground clearance or lean angle. What's more, all screw connections are recessed in the smooth floor. This not only increases durability but also ensures better off-road handling. The flat floor design is also suitable for work stands.

“State of the art“ technology coupled with „state of the art“ design. 100% Made in Germany.



**KTM 890 ADV / 890 ADV R / 790 ADV / 790 ADV R**

372-7132 Aluminium - for KTM centre stand

372-7133 Aluminium black - for KTM centre stand

372-7134 Aluminium/ Aluminium black - for KTM centre stand

**KTM 790 ADV / 790 ADV R**

372-5140 stainless steel/ Aluminium

372-5141 stainless steel/ Aluminium black



### Motor protection grid

KTM 890 ADV / 890 ADV R / 790 ADV / 790 ADV R

In order to optimise the protection of your KTM, Touratech has developed an engine guard for the original KTM engine protection / Touratech motor protection. The sturdy material guarantees the best possible protection and, thanks to the high-quality electro-polishing, fits perfectly into the design of the KTM. This all-round protection effectively protects the engine from stone chips and dirt that can get stuck behind the fairing. Mounting the grid is child's play - the motor guard does not even have to be removed. Material: 2 mm stainless steel



#### for KTM motor protection

372-5015

#### for motor protection \*RALLYE Evo\*

372-5016

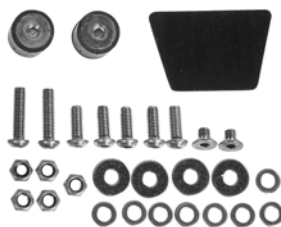
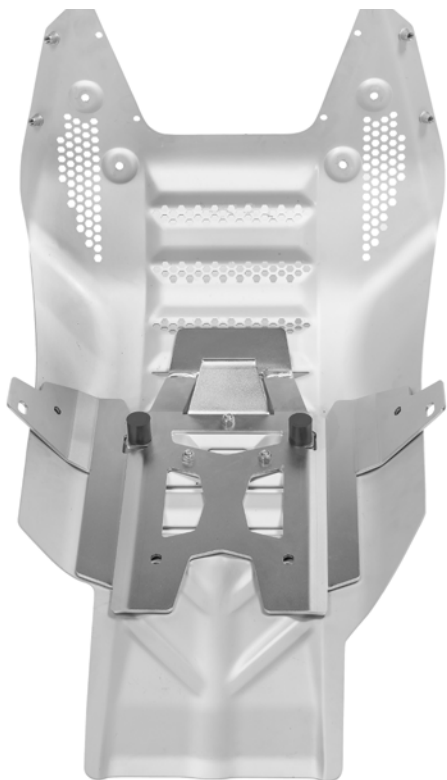

### Hard part for original engine guard

KTM 890 ADV / 890 ADV R / 790 ADV / 790 ADV R

The stainless steel part is discreetly screwed under the original engine guard of 790 Adventure and reinforces it effectively. Even in case of very hard impacts, the engine is protected against damage.

372-5158

## WORKS long-distance foot pegs

with ABE

KTM 890 ADV / 890 ADV R / 790 ADV / 790 ADV R

- 52 mm wide and 4 mm thick stainless steel claw profile that is kind to your boots
- Perfect combination of grip and self-cleaning
- With a more slender design for better ground clearance
- Significantly less susceptible to impacts
- Strengthened mounting point
- With a blasted surface and laser inscription for a superior finish

370-5315



## Pivot Pegz - MK4

KTM 890 ADV / 890 ADV R / 790 ADV / 790 ADV R

Pivot Pegz MK4 now with 6 cm wide and 10 cm long tread for even better grip!

Thanks to a spring joint, these foot pegs follow the forward and backward movements of the foot to an angle of 20 degrees. This protects the boot, and gives the rider a better position on the bike - even in extreme situations.

040-5523

040-5525 Toppers

040-5523



040-5525

## Folding brake lever attachment kit

KTM 890 ADV / 890 ADV R / 790 ADV / 790 ADV R

The foot brake lever can easily get bent in rocky terrain. Reason enough for us to replace the surface of the original one with a folding one. The original footrest is dismantled and the folding version fitted in its place.

370-1507

## Stainless steel foot brake pedal extension

KTM 890 ADV / 890 ADV R / 790 ADV / 790 ADV R

371-5390





## Touratech Suspension Steering Damper „Constant Safety Control“

The Touratech Suspension „CSC“ steering damper is developed specifically for the KTM and adjustable. The riding stability of your KTM is optimised effectively and can be individually fine adjusted via 24 clicks. Whether on tour with a full load or chasing through bends, you are always on the road with your personal setup.

372-5888 790 ADV

372-5889 790 ADV-R



## Progressive fork springs

These progressive fork springs are perfectly matched to the fork on the KTM. They make the fork better suited to the demands of motorcycle touring. You will also experience a significantly improved response and greater reserves in extreme situations. The fork springs are made in Europe by Dutch suspension specialists Hyperpro.

372-5880 790 ADV

372-5882 790 ADV -30 mm

372-5884 790 ADV-R

372-5886 790 ADV-R -30 mm

372-5890 890 ADV

372-5894 890 ADV-R

372-5896 890 ADV-R -30 mm

## Progressive replacement springs for fork and shock absorber

Full set by Hyperpro, the Dutch specialist for suspension products. The set includes replacement fork springs and a replacement spring for the shock absorber. The progressive springs have been designed to match the KTM 790/890 Adventure R perfectly, and offer a tremendous improvement in response and greater safety in extreme situations. Replacing the front and rear springs will lead to a significant improvement in your suspension system.

372-5881 790 ADV

372-5883 790 ADV -30 mm

372-5885 790 ADV-R

372-5887 790 ADV-R -30 mm

372-5895 890 ADV-R

372-5897 890 ADV-R -30 mm





## Touratech Suspension Cartridge Extreme

Putting it simply, the Touratech Suspension Cartridge Extreme is a suspension strut for the fork and the absolute top end in terms of suspension technology. The Closed Cartridge is installed into the original fork. This way the fork bridge/ handle-

bar mount, brakes and wheel control and handlebar geometry are retained in full. No additional modifications to the fork are required. This Closed Cartridge has been developed perfectly for touring and riding with frequent and strongly differing loads and riding conditions or extreme requirements.

372-5869	890/790 ADV
372-5874	890/790 ADV-R



## Touratech Suspension shock absorber

### Type Extreme

The Touratech Suspension Extreme shock absorber ranks in the absolute premium class of suspension components. This Extreme shock absorber for the KTM is perfectly suited to touring and riding with frequent dramatic changes in loading and riding conditions, and the most extreme demands. The Extreme shock absorber is fitted with a position sensitive damping system (PDS), which utilises a second damping piston to provide hydraulic protection against bottoming out. Even fully loaded with luggage under the most extreme off-road conditions, the bike will not bottom out and the shock absorber is protected against mechanical overload. Damping characteristics change depending on the road surface. When riding under most conditions, the shock absorber is comfortably adjusted for a less strenuous ride, before the PDS kicks in for the last portion of the shock absorber stroke.

372-5867	890/790 ADV
372-5868	790 ADV -30 mm
372-5872	890/790 ADV-R
372-5873	790 ADV-R -30 mm



## Touratech Suspension

Many advantages to other high-end brands! Touratech Suspension has been designed by TracTive Suspension. TracTive has specific, profound expertise of the Touratech type of motorbike models. They therefore understand the specific user and reliability require-

ments as no one else does. The shocks were developed for traction, comfort, dynamic safety, reliability and light weight. Every shock has been test driven with Touratech customers in mind. Detailed information on Touratech suspension and available variants can be found starting on page 596 !

372-5860	890/790 ADV	Level2
372-5866	890/790 ADV	Level2-30 mm
372-5870	890/790 ADV-R	Level2
372-5871	890/790 ADV-R	Level2-30 mm



## Comfort seat Fresh Touch one piece

KTM 890 ADV / 890 ADV R / 790 ADV / 790 ADV R

This seat significantly increases seating comfort, especially on long stretches.

The reason: the ultra-bi-elastic yet strong outer material, which makes the padding even more efficient. The integrated recess relieves the pressure on the coccyx and distributes the driver's weight over the whole seat. Thanks to the offset seams on the side and slim shape of the seat, there is no pressure against the thighs. All in all, a wonderful and comfortable seat for your 890 / 790!

The high quality, multi-layer seat cover is equipped with a durable Fresh Touch surface coating.

It reduces the surface temperature by significantly reflecting infrared light radiation and providing a cooler feeling when mounting a motorcycle parked in the sun. An additional, exclusive gain in comfort for your riding pleasure!

372-5962 low

372-5963 standard

372-5964 high



## Handlebar bag Ibarra Smart

KTM 890 ADV / 890 ADV R / 790 ADV / 790 ADV R

Practical storage space and waterproof smartphone holder - always within reach!

The highlight of our "Ibarra Smart" is the waterproof compartment for all common smartphones (up to approx. 9x16 cm). The fully sealed foil offers an optimal view of the screen and even allows the operation of most smartphones.

The mobile phone is inserted from the inside.

Thanks to a small opening you can connect your charging cable.

Under the lid there is a large, weatherproof main compartment (approx. 2.4 litres) for first aid kits, high-visibility vests or sunglasses. A further, smaller compartment allows quick access to important documents and other small items. The yellow lining helps you to find the contents of the bag more easily.

A key feature is that our bag doesn't in any way restrict the rider's movements or affect control of the bike. The use of certified Cordura guarantees highest material quality.

Dimensions: (L x W x H) approx. 33/17 x 8 x 13 cm

Volume: approx. 2.4 litres

055-1285



## Handlebar bag Ibarra

KTM 890 Adv / 890 ADV R / 790 ADV / 790 ADV R

A wide opening water-repellent dustproof zip provides easy access to a large main compartment in which the things you need quickly are well protected. A key feature is that our bag doesn't in any way restrict the rider's movements or affect control of the bike.

045-5827





## Bags Ambato for crash bars

372-5160, 372-5161, 372-5162 (1 pair)

KTM 890 ADV / 890 ADV R / 790 ADV / 790 ADV R

When you're planning a short trip out on your motorbike, it's often tricky to know where to put your map,

something to drink, your waterproofs, a spare pair of gloves, even something to clean your glasses with. Touratech has the solution in the shape of bags for the Touratech crash bars. They have just the right amount of space, especially for those little things.

372-5820



## Tail bag „Ambato“ for the luggage rack

KTM 890 ADV / 890 ADV R / 790 ADV / 790 ADV R

There is plenty of room on the original luggage rack for a strong, practical bag. It is perfect for storing waterproofs, spare gloves, tools and small amounts of shopping safely and out of the weather. Of course, this in no way impairs the passenger's comfort, and because the bag is far back on the vehicle, the rider is still able to get on with ease. The pannier slides onto the luggage rack from the back, is secured at the front with two straps, and the special base plate ensure that it remains safely in place.

Size: (L x W x H) approx. 30 x 30 x 19 cm;

Volume: approx. 13 litres

372-5811



## Tank bag Ambato Exp

KTM 890 ADV / 890 ADV R / 790 ADV /  
790 ADV R

As we develop and offer the exclusive base plates and strong attachment kits for our robust tank bags for each specific vehicle, it is a given that a perfect fit with no play at all should be achieved!

The Ambato Exp is also notable for the expansion option with an all-round zipper; small items can easily be stored under the adjustable elastic strap on the back.

Thanks to the water-repellent cable hole, it's now easy to charge a mobile phone in the tank bag -plus the side pockets have an expansion pleat, which means there's even more room inside them than you would think.

Size: (L x W x H) approx. ca. 30 x 15 x 19/26 cm  
Volume: approx. 7/10 litres

372-5800 black

372-5825 Rallye / orange



KTM 890 | 790 ADVENTURE / R

## Tank bag Ambato Pure

KTM 890 ADV / 890 ADV R / 790 ADV /  
790 ADV R

This minimalist tank bag is a practical, well thought out piece of equipment that represents outstanding value for money. Flatter in shape and with fewer adornments, this model is suitable for all kinds of uses. For instance, it provides enough space for a day trip, can hold documents, a mobile phone, wallet and drinks on the way to a city sightseeing tour, and is also the preferred choice for off-road riding as it doesn't restrict the rider's movements while standing or affect the bike's handling.

Size: (L x W x H) approx. ca. 30 x 15 x 19 cm  
Volume: approx. 7 litres

372-5802





### Scottailer vSystem chain lubrication system

KTM 890 ADV / 890 ADV R / 790 ADV / 790 ADV R

The Scottailer vSystem is a vacuum-controlled chain lubrication system which lubricates the chain while you are riding your motorbike - completely automatically. Chain wear is significantly reduced. Cleaning and lubrication is no longer necessary.

030-0177

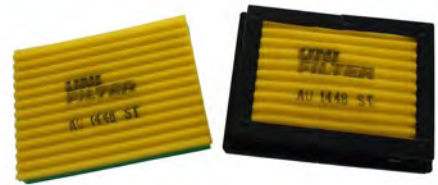

Snorckel pre-cleaners

### Unifilter

KTM 890 ADV / 890 ADV R / 790 ADV / 790 ADV R

The Touratech Research & Development team used the Unifilter and since then have found no dust residue in the air filter box. Another advantage of the filter, made of high-tech foam, is the long service life. The filter is not thrown away when it's dirty but rinsed out, lubricated again and used time and time again. So you don't just take care of your engine but also your wallet.

372-0870

371-0872 Snorckel pre-cleaners





### Touratech KTM motorcycle toolset, 70 PCS

The professional tools for your KTM motorcycle. A lot of great ideas and many impressive patent tools have been put into this one to ensure that we are always innovating for the better. The dream set for your road trips and any repair works you encounter.

All the tools are made with the best quality materials, S2 Bits with Black Phosphate finishing anti-rust. Cr-V Satin Chrome Plated sockets and spanners.

MIT (Metric/Inch/Torx): The MIT print work on various type of nuts: Square, 6 or 12 points, Star, Spline and damaged.

070-2212

### Tool kit for KTM motorcycles, CruzTools RoadTech RTKT1

For modern motorcycles special tools are needed. This applies especially to KTM motorcycles. We've exceeded these needs with this tool kit, which packs top grade tools and other roadside items into a sturdy roll-up pouch. The perfect tool kit for your KTM, made by CruzTools!

#### Contents:

- combination wrenches: 8 mm, 10 mm, 13 mm
- other wrenches: 20,32 cm (8")
- AdjustablePliers: 13,97 cm (5.5") curved jaw locking
- 0,64 cm (1/4") drive socket set: 48-tooth mini ratchet, 5,08 cm (2") Extension, 8 mm, 10 mm, 13 mm
- Hex keys: 2.5 mm, 3 mm, 4 mm, 5 mm, 6 mm
- hexalobular internal keys: T20, T25, T30, T40, T45
- Screwdriver: 6-in-1 reversible (2 Phillips, 2 Slotted, 6 mm and 8 mm Nut drivers)
- Tyre gauge (kPa-scale! -> 100kPa=1bar)
- Misc.: Locktite, tape, cable ties (5 pcs.), mechanical wire
- Pouch: roll-up, double-panel 600d Polyester with PVC backing (rolled up size: 24 x 9 cm)

070-2105





## Luggage rack

KTM 890 ADV / 890 ADV R / 790 ADV / 790 ADV R

Optimise the stowage of your luggage on your Adventure! The luggage rack, made of 4 mm thick aluminium, is precisely laser-machined and virtually doubles the usable surface area of the original KTM luggage rack.

372-5450



## Topcase rack

KTM 890 ADV / 890 ADV R / 790 ADV / 790 ADV R

Made entirely of stainless steel, the Topcase rack is the perfect way to attach ZEGA Pro / ZEGA Evo Topcases to your bike. To achieve optimum stability, the rack for the KTM is additionally supported on a subframe. This allows the Topcase to be positioned without getting in the pillion passenger's way, reduces vibrations, and results in improved safety. You will find the available Topcases on page 472.

372-5455

372-5456 black

Matching topcases can be found starting on page 472!







### Stainless steel pannier rack

KTM 890 ADV / 890 ADV R / 790 ADV / 790 ADV R

Touratech's stainless steel pannier rack for the KTM is a sturdy rack designed to take Touratech ZEGA Evo, ZEGA Pro and ZEGA Mundo cases. This is the perfect case system for extended touring. Made of 18 mm stainless steel tubing, this non-rusting system matches the appearance of the KTM frame and guarantees extra high stability even off the beaten track. Fitted as closely as possible to the vehicle frame using existing attachment points.

Just a few screws is all it takes for the very strong

construction to be securely attached (or removed). The angle brackets remain unobtrusive on the motorbike.

- made of 18 mm stainless steel tube
- also suitable for tough off-road use
- no restrictions to pillion
- blends elegantly with the overall look of the KTM
- easy to fit and remove
- overall width: 54 cm

372-5555

372-5560 black





### ZEGA aluminium pannier system

KTM 890 ADV / 890 ADV R / 790 ADV / 790 ADV R

The aluminium pannier system again has a very robust construction. We have tried to bring the pannier racks and the panniers as close as possible to the motorcycle. Numerous tests have already

been performed in order to ensure that the entire development satisfies the required demands. The rack is made of 18 mm steel tubing and is attached to existing mounting points using special fixing clips and reinforcing pieces. Pillion comfort not restricted in any way. Enhances the enduro and touring appearance.

Pannier System with:	stainless steel rack	stainless steel rack black
ZEGA Mundo 31/38 L	372-6130	372-6180
ZEGA Pro 31/38 L	372-5730	372-5780
ZEGA Pro AND-S 31/38 L	372-5731	372-5781
ZEGA Pro AND-Black 31/38 L	372-5732	372-5782

Pannier System with:	stainless steel rack	stainless steel rack black
ZEGA Mundo 38/45 L	372-6135	372-6185
ZEGA Pro 38/45 L	372-5735	372-5785
ZEGA Pro AND-S 38/45 L	372-5736	372-5786
ZEGA Pro AND-Black 38/45 L	372-5737	372-5787

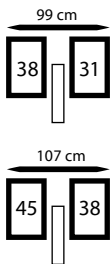

# ZEGA EVO

## ZEGA Evo aluminium pannier system

KTM 890 ADV / 890 ADV R / 790 ADV / 790 ADV R

The ZEGA Evo, like all Touratech panniers before it, was not developed as an isolated product but was intended from the outset to be part of a luggage system. The outstanding practical benefits are the result of the unique combination of an elegant and indestructible pannier, an ingenious fastening mechanism and a terrain-immune rack made of 18 mm thick stainless steel tubes.



	stainless steel rack	stainless steel rack black
AND-S 31 / 38 L	372-6831	372-6881
AND-Black 31 / 38 L	372-6832	372-6882
AND-S 38 / 45 L	372-6836	372-6886
AND-Black 38 / 45 L	372-6837	372-6887



## ZEGA Evo X special systems

KTM 890 ADV / 890 ADV R / 790 ADV / 790 ADV R

A typical feature of the special system is the recess on the right-hand pannier that allows it to nestle snugly against the exhaust. The panniers are positioned closer to the bike's centreline, the overall width is reduced, and the system as a whole appears more balanced thanks to the symmetrical pannier lids. Made from stainless steel, the sturdy pannier racks are scratch and rust resistant.

Special System with:	stainless steel rack	stainless steel rack black
ZEGA Evo X AND-S 38/38 litres	372-6816	372-6866
ZEGA Evo X AND-Black 38/38 litres	372-6817	372-6867
ZEGA Evo X AND-S 45/45 litres	372-6826	372-6876
ZEGA Evo X AND-Black 45/45 litres	372-6827	372-6877

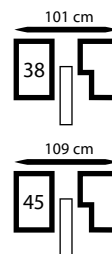



- 1** Handlebar | Cockpit | Windscreens | Lighting from page 382
- 2** Tank bag from page 383
- 3** Protection from page 383
- 4** Suspension from page 384
- 5** Case systems from page 385

# KTM

## 390 ADVENTURE





## GPS mounting adapter above instruments

Our „mounting adapter above instruments“ lets you keep your GPS device or road book firmly in view. No more looking down or distractions to the side - your eyes are always pointed at the road.

372-5415



## Handlebar riser, with ABE

Raising the handlebar by 25 mm results in a more upright, much more relaxed seating position. The adjustment range of the handlebar angle is increased, which further increases rider comfort. The Touratech handlebar riser also makes riding while standing less tiring, which is of tremendous benefit to taller riders in particular.

372-5255 25 mm



## Headlamp guard with quick release fastener

Touratech's headlight protector effectively prevents larger stones from damaging the headlight lens. Another great feature is the quick release fastener that lets you easily clip on the headlight protector and detach it again as needed.

The headlight protector has been developed for off-road use and is not permitted in the scope of German StVO. Please check your national regulations!

372-5095



## Folding brake lever attachment kit

The original footrest is dismantled and the folding version fitted in its place.

370-1507



## Stainless steel foot brake pedal extension

371-5390



### Tank bag Ambato Exp

As we develop and offer the exclusive base plates and strong attachment kits for our robust tank bags for each specific vehicle, it is a given that a perfect fit with no play at all should be achieved!

The Ambato Exp is also notable for the expansion option with an all-round zipper; small items can easily be stored under the adjustable elastic strap on the back.

Thanks to the water-repellent cable hole, it's now easy to charge a mobile phone in the tank bag - plus the side pockets have an expansion pleat, which means there's even more room inside them than you would think.

Size: (L x W x H) approx. 30 x 15 x 19/26 cm

Volume: approx. 7/10 litres

372-5800 black

372-5825 Rallye / orange



### Tank bag Ambato Pure

This minimalist tank bag is a practical, well thought out piece of equipment that represents outstanding value for money. Flatter in shape and with fewer adornments, this model is suitable for all kinds of uses. For instance, it provides enough space for a day trip, can hold documents, a mobile phone, wallet and drinks on the way to a city sightseeing tour, and is also the preferred choice for off-road riding as it doesn't restrict the rider's movements while standing or affect the bike's handling.

Size: (L x W x H) approx. 30 x 15 x 19 cm

Volume: approx. 7 litres

372-5802

### Engine crash bar stainless steel

A robust crash bar is almost obligatory to protect your new KTM from damage when it tips over during general use as well as when riding in tough terrain. The crash bar is made of 20 mm in diameter and 2 mm thick round tubing.

375-5155





### ABS sensor protection rear

The ABS sensor is very important for safety - and very easily damaged. So it goes without saying that we've developed a protector for this component. Especially on a bike like the KTM that's sure to see a gravel trail every once in a while. And you don't need to tell a seasoned off-roader about the sort of damage flying stones can cause.

Material: 1,5 mm stainless steel

372-5010



### Progressive fork springs

These progressive fork springs are perfectly matched to the fork on the KTM. They make the fork better suited to the demands of motorcycle touring. You will also experience a significantly improved response and greater reserves in extreme situations. The fork springs are made in Europe by Dutch suspension specialists Hyperpro.

375-5865

### E1 single shock absorber

Following intensive riding tests, the E1 shock absorbers have been individually configured to suit your particular motorcycle. This means that high-speed stability is improved and load changes that occur during sporty cornering are minimised. The large adjustment range allows perfect adjustment of balance and damping for a wide variety of uses, from sporty rides to leisurely weekend tours and holiday trips.

375-5860



### Topcase rack

KTM 390 ADV

Made entirely of stainless steel, the Topcase rack is the perfect way to attach ZEGA Pro / ZEGA Evo Topcases to your bike. To achieve optimum stability, the rack for the KTM is additionally supported on a subframe. This allows the Topcase to be positioned without getting in the pillion passenger's way, reduces vibrations, and results in improved safety. You will find the available Topcases on page 472.

375-5457



## Stainless steel pannier rack

Touratech's stainless steel pannier rack for the KTM is a sturdy rack designed to take Touratech ZEGA Evo, ZEGA Pro and ZEGA Mundo cases. This is the perfect case system for extended touring.

- made of 18 mm stainless steel tube
- also suitable for tough off-road use
- no restrictions to pillion
- blends elegantly with the overall look of the KTM
- easy to fit and remove
- overall width: 49 cm

375-5555



## ZEGA pannier system

The pannier system again has a very robust construction. We have tried to bring the pannier racks and the panniers as close as possible to the motorcycle. Numerous tests have already been performed in order to ensure that the entire development satisfies the required demands.

The rack is made of 18 mm steel tubing and is attached to existing mounting points using special fixing clips and reinforcing pieces. Pillion comfort is not restricted in any way. Enhances the enduro and touring appearance.

Pannier System with:	stainless steel rack
ZEGA Mundo 31/38 L	375-6130
ZEGA Pro 31/38 L	375-5730
ZEGA Pro AND-S 31/38 L	375-5731
ZEGA Pro AND-Black 31/38 L	375-5732

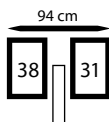

## ZEGA Evo pannier system with stainless steel rack

The ZEGA Evo, like all Touratech panniers before it, was not developed as an isolated product but was intended from the outset to be part of a luggage system. The outstanding practical benefits are the result of the unique combination of an elegant and indestructible pannier, an ingenious fastening mechanism and a terrain-immune rack made of 18 mm thick stainless steel tubes.

Pannier System with:	stainless steel rack
AND-S 31 / 38 L	375-6831
AND-Black 31 / 38 L	375-6832





NEW IDEAS FOR MOTORBIKES

**TOURATECH**





# TRIUMPH

## TIGER 900

- 1 Handlebar | Cockpit | Windscreens | Lighting from p. 388
- 2 Engine guard | Cylinder protection | Fairing from p. 390
- 3 Foot pegs from p. 392
- 4 Touratech Suspension from p. 393
- 5 Tank bags and Tail rack bags from p. 394
- 6 Pannier systems from p. 396



## Windscreen spoiler Evo

Whether you need it for your original windscreen or as accessory to your new Touratech windscreen - with Touratech's windscreen spoiler Evo, you absolutely gain extra comfort on each terrain.

Evo offers the right balance between protection and ventilation - whether you drive on motorways, roads or off-road. Height, inclination and distance to the windscreen can easily be adjusted - you do not need any tools.

If you are going fast and the weather is rainy, fasten the

spoiler at its highest level to benefit from an effective wind and weather protection. It is a noticeable relief for your head and upper body, and wind noises in your helmet are significantly reduced.

If you set the lowest level, the windscreen spoiler almost disappears. This guarantees maximum ventilation when riding off-road.

040-1380 transparent

040-1381 tinted



## GPS mounting adapter for handlebar clamp

Triumph Tiger 900 Rally | Rally Pro

Touratech's GPS mounting adapter for the handlebar clamp on the Triumph Tiger simply attaches onto the Triumph's handlebar mounting clamps. Nearly all our GPS brackets fit perfectly on its 12 mm strut. For easy, safe attachment of your GPS. Does not block your view of the instruments.

421-5410



## Crossbar

For some time now, many enduro bikes have not been equipped with a crossbar. Many enduro riders with high handlebars equipped their bike with one as it is ideal for mounting some interesting accessories: - Roadbook holders - GPS receivers - Motorcycle computers - Map holders - and many more

To fit all these accessories you will need to mount our crossbar.

040-0603 22/25 290 mm

## Headlamp guard black with quick release fastener

Triumph Tiger 900 Rally | Rally Pro

- effective protection of the headlamp glass
- made of laser-machined, anodised aluminium
- robust design, even stops larger stones
- quick release fastener for removal and refastening
- fantastic look

The headlight protector has been developed for offroad-use and is not permitted in the scope of German StVO. Please check your national regulations!

421-5095



OFFROAD  
USE ONLY



TIGER 900



## Radiator protector black

Triumph Tiger 900 Rally | Rally Pro

The Touratech radiator protector shields the vulnerable lamellae of the radiator against damage and thus provides an enormous safety benefit! The dread of flying stones, sticks or other debris will be no more. A small investment will make your trip a whole lot safer! Optically unobtrusive

yet in the unmistakable Touratech-style, the radiator protector made of laser cut aluminium blends in with the Triumph design perfectly. Parts supplied: 2 parts (left and right) Note: The radiator cover can cause the engine to overheat under extreme conditions with high outside temperatures and an extreme engine load. Please watch your water temperature gauge.

421-5015



## Engine crash bar

### Triumph Tiger 900 Rally | Rally Pro

A robust crash bar is almost obligatory to protect your new Triumph from damage when it tips over during general use as well as when riding in tough terrain. The crash bar is made of 25 mm in diameter and 2 mm thick round tubing. The stainless steel bar is designed to prevent your valuable motor coming into contact with the ground in the event of a fall. Due to the sophisticated shaping, the forces are absorbed, preventing any damage occurring, in most cases. In addition to its undeniable functionality, this stainless steel crash bar features a stylish design, giving your Tiger 900 the right Adventure look!

421-5155

421-5156 black

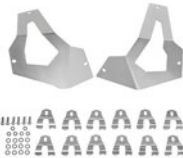

## Reinforcement for engine crash bar 421-5155 / 421-5156

### Triumph Tiger 900 Rally | Rally Pro

Every adventure can take its toll! Don't let your motorbike have to pay for it. Protect the three cylinder engine of your Triumph effectively with the Touratech crash bar. The additional reinforcement, which is easily attached directly to the bar with 3 clamps, ensures absolute stability and a great adventure look. The 2 mm thick stainless steel plate covers important parts of the engine which can easily be damaged by stone chips. The stainless material is also very easy to clean. Scratches are polished out in no time.

Only in combination with engine crash bar 01-421-5155-0 / 01-421-5156-0.

421-5150



## Fairing crash bar

### Triumph Tiger 900 Rally | Rally Pro

The crash bar is made of high quality, electropolished stainless steel and extends the range of use of your travel enduro. The two-component crash bar was fitted as close as possible to the vehicle to give harmonious integration into the existing vehicle design. Its special design provides optimal force dissipation and largely protects the radiator as well as the tank and fairing against damage. The crash bar is simple to install, rust-proof and easy to care for.

Material: Stainless steel

421-5160

421-5161 black



## „Expedition“ engine guard / skid plate

### Triumph Tiger 900 Rally | Rally Pro

Serious damage, such as holes in the engine block, can be effectively prevented by fitting the large Touratech engine guard.

Maximum strength is provided by multiple folded ridges in the 4 mm thick aluminium base plate, while an additional lower stainless steel attachment plate on the engine ensures the force of an impact is distributed over a large area via several bolting points. Ground clearance is not restricted by these two base plates. Plastic rails on the lower part of the base plate ensure that the bolt heads - which are already sunken - are completely covered.

421-5140



## Engine guard extension

### Triumph Tiger 900 Rally | Rally Pro

We have developed an engine guard extension to go with our engine guard. The design is the same, technically and optically. The extension closes the gap between the engine guard and the rear wheel. An unbeatable advantage, especially off-road! Nothing can get stuck or caught around the main stand. The engine guard extension also protects the Suspension deflection from stones and other kinds of dirt that get thrown up. Also really useful in road use! The many angles of the 4-mm thick aluminium sheet provide maximum stability. There is no restriction of ground clearance. The engine guard extension attaches to the main stand in moments.

421-5145



## Chain guard

### Triumph Tiger 900 Rally | Rally Pro

Touratech's chain guard for the Tiger 900. Much sturdier than the original plastic part, the Touratech chain guard is made from stainless steel and aluminium yet is still relatively light. Visually the metal chain guard fits much better with the overall concept of a touring enduro like the Tiger 900. The chain guard is simple and quick to fit as it attaches to the existing mounting points.

421-5045



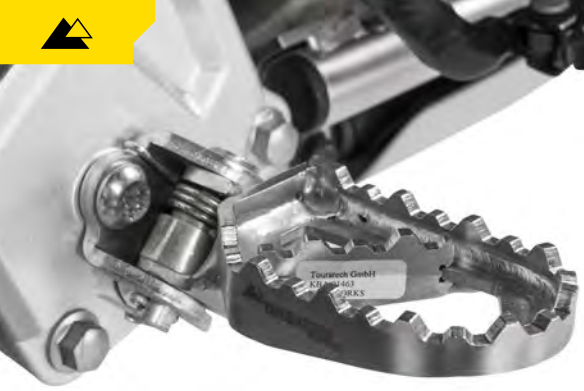

## WORKS Long-Distance Foot Pegs with ABE

Triumph Tiger 900 Rally | Rally Pro

- 52 mm wide and 4 mm thick stainless steel claw profile that is kind to your boots
- Perfect combination of grip and self-cleaning
- With a more slender design for better ground clearance
- Significantly less susceptible to impacts
- Strengthened mounting point
- With a blasted surface and laser inscription for a superior finish

420-5315

## Side stand base extension

Triumph Tiger 900 Rally | Rally Pro

The side stand base extension more than doubles the area of the supporting surface, so you won't find yourself straining to lift the fully loaded machine. A mix of stainless steel and black anodised aluminium components ensure the base extension looks good and provide full stability. Securely fixed to the side stand, the base extension is a useful accessory that is always there to save you a lot of hassle and frustration.

421-5275 for side stand part no. 2086415

421-5276 for side stand part no. 2089989



## Touratech Professional toolsets, 70 pcs

Work like a pro!

The unique, innovative professional toolset is especially designed for the regular service and for repairing motorcycles on the way. The compact set covers all essential applications and is therefore an ideal companion, from day trips up to world trips.

A great compact tool set that allows you to do 80% of adjustments and repair works on your motorcycle.

070-2213



## Manufacturer specific tool kits by CruzTools

For modern motorcycles special tools are needed. This applies to Japanese motorcycles as well as to European motorcycles.

We've exceeded these needs with this tool kit, which packs top grade tools and other roadside items into a sturdy roll-up pouch.

070-2104







TIGER 900



Progressive fork springs for Tiger 900 Rally / Rally Pro (2020-2021)	421-5880
Progressive replacement springs for fork and shock absorber, for Tiger 900 Rally / Rally Pro (2020-2021)	421-5881
Height lowering kit -20mm for Tiger 900 Rally / Rally Pro (2020-2021) replacement springs	421-5883
Progressive fork springs for Tiger 900 Rally / Rally Pro (2020-2021) -20mm lowering	421-5882
Touratech Suspension shock absorber for Triumph Tiger 900 Rallye Pro from 2020 type Level 2	421-5860
Touratech Suspension shock absorber for Triumph Tiger 900 Rallye Pro from 2020 type Extreme	421-5865
Touratech Suspension Cartridge Kit Extreme for Triumph Tiger 900 Rallye Pro from 2020	421-5870
Touratech Suspension lowering shock (-20mm) for Triumph Tiger 900 Rallye Pro from 2020 Type Explore HP/PDS	421-5861
Touratech Suspension Touratech Suspension lowering Cartridge Kit -20mm for Triumph Tiger 900 Rallye Pro from 2020	421-5871
Touratech Suspension lowering shock (-20mm) for Triumph Tiger 900 Rallye Pro from 2020 Type Extreme	421-5866



## Tank bag Ibarra Midi

Triumph Tiger 900 Rally | Rally Pro

The Ibarra Midi tank bag fits perfectly on the compact tanks of the vast majority of touring enduros. An expandable main compartment, two zipped outer pockets and a removable map pocket offer sufficient volume on long tours. The cable grommet and credit card pocket in the lid are Touratech standard.

The tank bag is made of high-quality, certified Cordura. Elasticated drawstrings with quick-release fasteners, branded zips from YKK and reflective elements from 3M round off the high-quality features. The ingeniously simple strap lock and the clip locks allow uncomplicated refuelling.

Size: (L x W x H) approx. 30 x 15 x 19/26 cm, Vol.: approx. 7/10 litres

055-1286



## Pillion seat bag Ambato Exp

Triumph Tiger 900 Rally | Rally Pro

The perfect solution for more luggage: „Ambato Exp“! Anyone who expects more of a pillion bag than others really should take a closer look at the „Ambato Exp“ series! With two outer pockets, a large main compartment, the elastic drawstring on the top, the all-round zipper for when you want to increase its size and the practical carrying handle, this pillion bag can cope with any challenge! In looks, it matches the other luggage solutions in the Ambato series, and is easily attached to the vehicle-specific base by means of two easy-opening zippers.

Size: (L x W x H) approx. 35 x 26 x 18/25 cm

Volume: approx. 14/22 litres

055-1282

## Pillion Seat Bag AMBATO PURE

Triumph Tiger 900 Rally | Rally Pro

This is the one that offers maximum benefit for minimum expense!

If you're looking for a high-quality, sturdy and rugged pillion bag that takes up the least amount of space, doesn't get in the rider's way, is easy to mount and also offers some nice, practical features, then this is the right one for you. You can be sure that we haven't cut any corners on our AMBATO PURE pillion bag: Despite its flatter design, this bag still offers an impressive amount of space. It's made of Cordura fabric, so it can take on the toughest demands and most extreme conditions, and its superb workmanship is legendary.

An outstanding value for the money that's very hard to resist!

Size: (L x W x H) approx. 33 x 30 x 15 cm

Volume: approx. 14 litres

055-1283



## Handlebar bag Ibarra Smart

Practical storage space and waterproof smartphone holder - always within reach!

The highlight of our "Ibarra Smart" is the waterproof compartment for all common smartphones (up to approx. 9x16 cm). The fully sealed foil offers an optimal view of the screen and even allows the operation of most smartphones. The mobile phone is inserted from the inside. Thanks to a small opening you can connect your charging cable.

Under the lid there is a large, weatherproof main compartment (approx. 2.4 litres) for first aid kits, high-visibility vests or sunglasses. A further, smaller compartment allows quick access to important documents and other small items. The yellow lining helps you to find the contents of the bag more easily.

A key feature is that our bag doesn't in any way restrict the rider's movements or affect control of the bike. The use of certified Cordura guarantees highest material quality.

Dimensions: (L x W x H) approx. 33/17 x 8 x 13 cm

Volume: approx. 2.4 litres

055-1285



TIGER 900

## Handlebar bag Ibarra

A wide opening water-repellent dustproof zip provides easy access to a large main compartment.

A key feature is that our bag doesn't in any way restrict the rider's movements or affect control of the bike.

045-5827





## ZEGA aluminium pannier system

The aluminium pannier system again has a very robust construction. We have tried to bring the pannier racks and the panniers as close as possible to the motorcycle. Numerous tests have already been performed in order to ensure

that the entire development satisfies the required demands.

The rack is made of 18 mm steel tubing and is attached to existing mounting points using special fixing clips and reinforcing pieces. Pillion comfort not restricted in any way. Enhances the enduro and touring appearance.

Pannier System with:	stainless steel rack	stainless steel rack black
ZEGA Mundo 31/38 L	421-6130	421-6180
ZEGA Pro 31/38 L	421-5730	421-5780
ZEGA Pro AND-S 31/38 L	421-5731	421-5781
ZEGA Pro AND-Black 31/38 L	421-5732	421-5782

Pannier System with:	stainless steel rack	stainless steel rack black
ZEGA Mundo 38/45 L	421-6135	421-6185
ZEGA Pro 38/45 L	421-5735	421-5785
ZEGA Pro AND-S 38/45 L	421-5736	421-5786
ZEGA Pro AND-Black 38/45 L	421-5737	421-5787

## ZEGA Topcase rack

### Triumph Tiger 900 Rally | Rally Pro

You don't need any great mechanical skills to fit the Touratech luggage rack for the Zega Topcase to the standard luggage rack on the Triumph Tiger 900. The luggage rack attaches securely to four mounting points and

can withstand heavier loads than the original product. The Topcase itself is even easier to attach. With Touratech's ingenious RapidTrap mounting system, the Topcase quickly "clicks" on or off. Made from electropolished stainless steel.

- 421-5455
- 421-5456 black





TIGER 900

# ZEGA EVO

## ZEGA Evo aluminium pannier system

The ZEGA Evo, like all Touratech panniers before it, was not developed as an isolated product but was intended from the outset to be part of a luggage system. The outstanding practical benefits are the result of the unique combination of an elegant and indestructible pannier, an ingenious fastening mechanism and a terrain-immune rack made of 18 mm thick stainless steel tubes.

	stainless steel rack	stainless steel rack black
AND-S 31 / 38 L	421-6831	421-6881
AND-Black 31 / 38 L	421-6832	421-6882
AND-S 38 / 45 L	421-6836	421-6886
AND-Black 38 / 45 L	421-6837	421-6887

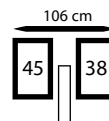
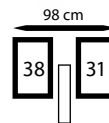

## Stainless steel pannier rack

### Triumph Tiger 900 Rally | Rally Pro

Touratech's stainless steel pannier rack for the Triumph Tiger 900 is a sturdy rack designed to take Touratech Zega cases. This is the perfect case system for extended touring. Made of 18 mm stainless steel tubing, this non-rusting system matches the appearance of the Triumph Tiger's frame and guarantees extra high stability even off the beaten track. It fits onto the existing attach-

ment points. The extremely strong cross-brace design will withstand heavy off-road use without any trouble and is an elegant complement to the overall styling of the Triumph Tiger 900. The luggage racks, which are fully suitable for use on all kinds of track and terrain, also emphasise the long-distance touring look. The racks do not restrict the pillion passenger in any way.

421-5555

421-5560 black





- 1 Handlebar | Cockpit | Windscreens | Lighting from p. 400
- 2 Engine guard | Cylinder protection | Fairing from p. 406
- 3 Foot pegs from p. 414
- 4 Seats page from p. 414
- 5 Suspension from p. 416
- 6 Tank bags from p. 419
- 7 Pannier systems from p. 422

# YAMAHA

## TÉNÉRÉ 700





### GPS mounting adapter above instruments

Our „mounting adapter above instruments“ lets you keep your GPS device or road book firmly in view. No more looking down or distractions to the side - your eyes are always pointed at the road.

632-5415

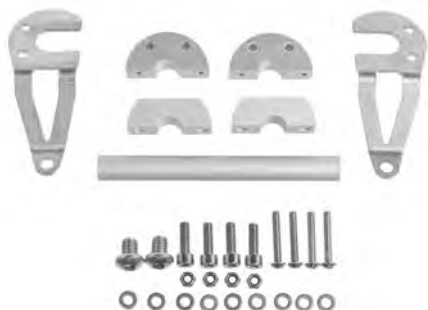

### GPS Handlebar Bracket Adapter

The bracket adapter is simply fitted to the handlebar mounting clamps on your T7. Our GPS brackets all fit perfectly on its 12 mm brace. For easy, safe attachment of your GPS. With no impairment of the view of the instruments.

632-5410

### GPS handlebar bracket adapter with screws for handlebar risers

632-5411 for 20 mm



### Handlebar riser, with ABE

Raising the handlebar by 20 mm results in a more upright, much more relaxed seating position. The adjustment range of the handlebar angle is increased, which further increases rider comfort. The Touratech handlebar riser also makes riding while standing less tiring, which is of tremendous benefit to taller riders in particular.

632-5255 20 mm



### Kaoko Cruise Control, mechanical cruise control

Yamaha Ténéré 700

330-0053



### Rear view mirror adapter set

1 x M10x1.25 right on M10x1.25 right  
1 x M10x1.25 right on M10x1.25 left  
For mounting all replacement mirrors with right-hand thread.

040-0778





## Touratech brake and clutch lever set, adjustable, folding and length adjustable

Yamaha Ténéré 700

The Touratech levers are milled in the mass from high-strength aluminum as in aircraft construction. They are 6-way adjustable and hinged. In case of a fall the lever can fold up without breaking. In normal operation, the levers are protected by a fold-up mechanism. The levers are adjustable in length by dovetail connection by 35mm. The anodization meets the highest quality standards. All screw connections comply with the DIN standard and are tightened before delivery with the torque wrench. The CNC levers are delivered with German ABE (General Operating Permit) and are therefore registration free.

632-5640

632-5641 short



632-5640



632-5641

## Hand protectors GD

These hand protectors are made of virtually indestructible plastic; they are modern in design, offer a high level of protection, and can easily be fitted to the T7 using the fitting sets (included). Only in combination with handlebar riser 632-5255.

632-5650 black

632-5654 white

Spoiler

040-7301 black



## DEFENSA Leverguard (Set)

Yamaha Ténéré 700

For all motorbike purists, but thoughtful of their machine, the Defensa Leverguard will provide the right level of protection for the front brake and clutch levers. To prevent you braking one or the other levers, Touratech proposes a simple, useful and aesthetic solution: the Defensa Leverguard. They do not only protect your levers in case of a crash, but they furthermore protect the levers from being hit by e.g. tree branches or car mirrors.

Made of high-strength drop forged aircraft aluminum and finished with a plastic nozzle as a matter of design, they are lightweight and stylish. It can be adapted to become another variant of our Defensa portfolio: Pure or Expedition.

632-5655





Defensa EXTENSION (SPOILER)



Defensa EXPEDITION + EXTENSION



Defensa EXPEDITION



Defensa PURE

## Hand protectors DEFENSA

### Yamaha Ténéré 700

Whether off-road riding or touring – the Touratech Defensa offers reliable protection for handlebar fittings and hands, so that a minor mishap does not turn into a major problem. With the Defensa, Touratech has developed an extra-robust protector for handlebar fittings and hands. The construction made of high-strength aircraft aluminium is precisely adapted to your motorbike model. Thanks to the „Defensa System“, the protector offers interesting variation possibilities. Whether you choose a pure protector or a wide protector with an extra spoiler... Defensa hand protectors – for a particularly wide range of uses. The handlebar fittings are among the most vulnerable assemblies on a motorbike. The solid protector reliably protects the levers from damage. The closed protectors have a bracket that is supported near the clamping blocks as well as at the end of the handlebars, thus completely framing the armature. This principle has proven itself in rally motorbikes under the toughest conditions. The system consists of two bolted main components and an attachment kit. There is always the required space behind the protector so that the levers can move freely. The annoying hitting, especially of the clutch lever, on the protector, as known from universal products, is a thing of the past with the Defensa. The components of the Defensa are made of a high-strength forged aluminium alloy, as proven in aircraft construction. With a thickness of 14 millimetres, the dimensions have been chosen generously without losing sight of the issue of weight. Precision manufacturing ensures excellent dimensional ac-

curacy and thus a precise fit. The model-specific adaptation ensures tension-free installation and full steering angle.

### Simple adaptation for on- and off-road use

For pure off-road use, it is recommended to use the Defensa „Pure“ version, where only the bar is mounted. For mixed use, there is the Defensa „Expedition“, which is fitted with a plastic wind deflector. The plastic shell is slid over the main hoop and clamped to the screw connection of the two aluminium components, ensuring a precise and secure fit. If you need even more weather protection, you can also fit the separately available „Extension“ spoiler. Of course, the Defensa Expedition can easily be converted back to the Pure.

### Defensa Pure

632-5649 silver

632-5660 black

### Defensa Expedition

632-5651 silver / black

632-5652 silver / white

632-5661 black / black

632-5662 black / white

### Defensa Extension

102-5651 black

102-5652 white

632-5090

**OFFROAD  
USE ONLY**



632-5095

### Headlamp guard with quick release fastener

Touratech's headlight protector effectively prevents larger stones from damaging the headlight lens.

Another great feature is the quick release fastener that lets you easily clip on the headlight protector and detach it again as needed.

The headlight protector has been developed for off-road use and is not permitted in the scope of German StVO. Please check your national regulations!

632-5095

632-5090 Makrolon



### Set of LED auxiliary headlights fog/fog

Yamaha Ténéré 700

Enjoy all the benefits of modern LED technology on your motorbike!

More light and innovative technology means more safety, while the bike looks better thanks to the „Adventure design“ - and everything is in the customary Touratech quality. All you have to do is ride!

ECE and SAE-approved, so no need to change your records!

632-5471



## Windshield MRA touring windscreen (TM)

With its 204 kg, the slim waisted and high Ténéré is light-weight, has a wonderfully smooth steering behaviour and is fun as a travelling companion and as a sports friend.

The 40 cm long MRA touring windscreen (TM) offers good wind protection in every situation. No separate installation material required - simply reuse the original screws for installation. The touring windscreen is colourless.

632-0880

## Windscreen adjuster for original windscreen

Yamaha Ténéré 700

The search is over for a windscreen that works! Discover for yourself what best suits your individual needs with our infinitely variable windscreen adjuster (up to 60 mm). And best of all, you can keep using your bike's original screen.

Windscreens are like seats: a whole lot of different factors influence your personal requirements for the product. Your height, the type of helmet you wear, even your seating position – they all determine whether a windscreen works or not.

Material: Stainless steel - electropolished

632-5330





## Windscreen Adjustment Pro

### Yamaha Ténéré 700

The Touratech Windscreen Adjustment Pro offers significantly improved weather protection and customisable aerodynamics on board the Yamaha Ténéré 700. This product is easy to install and allows you to conveniently adjust your windscreen height to any one of seven positions with one hand.

The Touratech Windscreen Adjustment Pro enables you to realise the maximum of weather protection on board your T7 and still reacts flexibly to the requirements presented by different riding conditions - the greatest possible amount of fresh air in demanding off-road terrain and the best possible wind protection on fast connecting stages.

The adjustment adapter is screwed to the original screen fixing and carries the windscreen. Made from a high-

quality, black anodised, aluminium alloy, this component with its technical look harmonises perfectly with the rally look of the Ténéré cockpit. The Adjustment Pro is not solely designed for standard screens, it also works with all accessory screens that use the original fixing.

In its lowest position, the windscreen is 12 millimetres higher than standard. The height can be varied to provide an additional 60 millimetres over a total of seven positions.

While the lowest position is perfect for off-road riding, where you need a view of the front wheel, the higher positions allow you to optimise wind protection. The individual adjustment options also allow you to adapt airflow behaviour to your speed of travel, to your own stature and to the aerodynamic characteristics of the helmet you wear.

The windscreen position is very simple to adjust. Without tools, within fractions of a second and with only one hand. Special springs together with the precisely crafted mechanism guarantee secure locking in each of the seven positions.

The steering lock remains unaffected and, using either the original bracket or Touratech brackets, navigation devices can be attached without restriction.

The Touratech Windscreen Adjustment Pro for the Yamaha T7 is easy to install and requires no registration.

- Convenient operation with one hand
- 60 millimetre adjustment range
- Simple installation

632-5331





### Stainless steel fairing crash bar

The Touratech fairing crash bar fits as closely as possible to the T7 thus adapting the innovative, sportive design of the Yamaha. The special construction guarantees optimum diversion of forces and protects cooler and fairing against damage when the bike falls over or in case of a crash.

632-5162

632-5163 black



### Engine crash bar stainless steel

Touratech's engine crash bar provides optimum protection for the engine's important side panels. Its slender design does not affect the lean angle at all and means you can ride on difficult single trails off-road as well as on-road. Made from resilient stainless steel, the engine crash bar gleams thanks to its high quality electropolished/ black finish. It perfectly complements the T7. The crash bar is made of high quality, electropolished stainless steel and extends the range of use of your travel enduro. The two-component crash bar was fitted as close as possible to the vehicle to give harmonious integration into the existing vehicle design. Its special design provides optimal force dissipation.

632-5160

632-5161 black



## Engine Guard EXPEDITION

### Yamaha Ténéré 700

Serious damage, such as holes in the engine block, can be effectively prevented by fitting the large Touratech engine guard. Maximum strength is provided by multiple folded ridges in the 4 mm thick aluminium base plate, while two additional lower 4 mm stainless steel attachment plates on the engine ensures the force of an impact is distributed over a large area via 8 bolting points. Ground clearance is not restricted by these two base plates.

632-5140 EURO4

632-5141 EURO4 black

632-5142 EURO5

632-5143 EURO5 black





## Engine protector RALLYE

### Yamaha Ténéré 700

With our RALLYE engine protector we combine modern production techniques with a unique design for the best possible protection of the entire engine area of your bike! The engine protector blends in stylishly with the lines of your motorbike. Thanks to innovative production technology, there are no disturbing welds, which are often considered to be a vulnerable point. The recesses on the underside don't only look good. In the event of the protector having to live up to its name, they provide the shock absorbing and lightweight aluminium with a robust stiffness. And as well as that, the two parallel recesses allow the bike to almost glide over obstacles. In this way, the energy of the impact is effectively dissipated, preventing jamming or snagging.

632-5135 EURO4

632-5136 EURO4 black

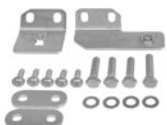





## Engine cover (Set)

### Yamaha Ténéré 700

The new motorcycle from Yamaha is made for long journeys and also off-road use. Now, don't let the crashes and flying stones get you down! Protect the engine of your Ténéré with the Touratech protective cover! The 2 mm thick aluminium grille effectively protects both sides of the exposed engine. In addition, it protects the sensitive throttle reversing system, which can easily be damaged without the cover. The cover is mounted with the original screws.

632-5436

632-5435 black



## Radiator protector black

The Touratech radiator protector shields protects the vulnerable lamellae of the radiator against damage and thus provides an enormous safety benefit! The dread of flying stones, sticks or other debris will be no more. A small investment will make your trip a whole lot safer! Optically unobtrusive yet in the unmistakable Touratech-style, the radiator protector made of laser cut aluminium blends in with the T7 design perfectly.

632-5015



## Pillion handles / Rescue handles

### Yamaha Ténéré 700

To guarantee a better grip for the pillion rider, Touratech has developed handles especially for the Ténéré 700. In addition, these can be used as rescue handles and thus make it much easier to raise up the bike. The handles can be mounted very easily - also together with Touratech luggage carriers.

Features:

- 18 mm sturdy stainless steel tube
- Grab and rescue handle in one
- Mounting material included in delivery
- Compatible with Touratech luggage carriers

632-5552

632-5553 black



## Rear brake fluid reservoir guard black

### Yamaha Ténéré 700

Made from black anodised aluminium, Touratech's brake fluid reservoir guard effectively prevents damage and undesired access to the reservoir lid, yet you can still easily see the fluid level. The guard simply bolts onto the existing mounting point.

632-5030





## Water pump protection

### Yamaha Ténéré 700

Complete the sporty adventure look of your T7 and effectively protect the rather exposed water pump! The water pump of the Ténéré 700 is quickly damaged in case of rockfall or a fall. In this case, you can't even think about continuing your journey. Our water pump protection offers optimal protection here. The protector is made of laser-cut, black anodized aluminum. Specially developed for the T7, it is light, robust and easy to mount on existing mounting points. Small part with great effect!

632-5535



## Brake cylinder guard

### Yamaha Ténéré 700

The rear brake cylinder of the Ténéré 700 is not protected. Therefore it is very likely to be damaged during a fall and also gets dirty very quickly. When riding off-road, you can easily catch your boots. Our extremely durable brake cylinder cover made out of 2 mm stainless steel protects the brake cylinder and your boots.

632-5525



## ABS sensor protection rear

### Yamaha Ténéré 700

The ABS sensor is very important for safety - and very easily damaged. So it goes without saying that we've developed a protector for this component. Material: 1,5 mm stainless steel

632-5010



## Engine crash bar with toolbox

The practical toolbox is solidly bolted to the specially developed crash bar near the engine, keeping the centre of gravity low. Made of impact-resistant ABS, it has a low weight and a large volume. Its capacity is approx. 3.5 litres - enough for the on-board tools, the first aid kit or the puncture kit. The large opening, which allows easy loading, is closed with a removable splash-proof lid. You already have a Touratech crash bar installed? No problem, order the box with the left-hand crash bar (632-5166/632-5168).

**632-5165** Box with crash bar complete stainless steel

**632-5166** Box with crash bar left stainless steel

**632-5167** Box with crash bar complete stainless steel, black

**632-5168** Box with crash bar left stainless steel, black



## Chain Guard Sport

Yamaha Ténéré 700

Sportier, lighter and leaner than the original part. The robust, laser-cut aluminium chain guard replaces the original chain guard and offers reliable protection from a broken chain or a chain that has come off. The original fitting points are retained; it is therefore very easy to fit. It also vastly improves the Ténéré's looks, and emphasises its sporty lines.

**632-5046**



## Chain guard, black

Yamaha Ténéré 700

Touratech's chain guard for the Ténéré 700. Much sturdier than the original plastic part, the Touratech chain guard is made from stainless steel and aluminium yet is still relatively light. Visually the metal chain guard fits much better with the overall concept of a touring enduro like the Ténéré 700.

**632-5045**

## Splash guard under number plate

### Yamaha Ténéré 700

For more than 10 years, Touratech splash guards have been watching the backs of riders and passengers, keeping them dry and clean, and protecting number plates from shaking loose. However, no matter how simple or good the product, development never stops. The Touratech splash guard has been specially adapted to the contours of the number plate holder. Beautifully integrated in the vehicle design, it is also suitable for smaller number plates.

- Made of black anodised aluminium
- Effective protection against splashes
- Also reinforces the number plate

632-5000



## Brake lever extension

### Yamaha Ténéré 700

Our brake lever extension will make sure that your boot always finds its way to the lever - and makes operation much easier and noticeably better.

Material: high quality stainless steel, electropolished

632-5390



## Side stand base extension

### Yamaha Ténéré 700

The side stand base extension more than doubles the area of the supporting surface, so you won't find yourself straining to lift the fully loaded machine.

632-5276



## WORKS Long-Distance Foot Pegs, with ABE

- 52 mm wide and 4 mm thick stainless steel claw profile that is kind to your boots
- Perfect combination of grip and self-cleaning
- With a more slender design for better ground clearance
- Significantly less susceptible to impacts
- Strengthened mounting point
- With a blasted surface and laser inscription for a superior finish

632-5315

## Comfort seat Fresh Touch one piece

This seat significantly increases seating comfort, especially on long stretches.

The reason: the ultra-bi-elastic yet strong outer material, which makes the padding even more efficient. The integrated recess relieves the pressure on the coccyx and distributes the driver's weight over the whole seat. Thanks to the offset seams on the side and slim shape of the seat, there is no pressure against the thighs. All in all, a wonderful and comfortable seat for your T7!

632-5962 low

632-5963 standard

632-5964 high

## Fresh Touch

The high quality, multi-layer seat cover is equipped with a durable Fresh Touch surface coating. It reduces the surface temperature by significantly reflecting infrared light radiation and providing a cooler feeling when mounting a motorcycle parked in the sun. An additional, exclusive gain in comfort for your riding pleasure!



-10 °C | -50 °F



## Touratech Professional toolsets, 70 pcs

Work like a pro!

The unique, innovative professional toolset is especially designed for the regular service and for repairing motorcycles on the way. The compact set covers all essential applications and is therefore an ideal companion, from day trips up to world trips.

A great compact tool set that allows you to do 80% of adjustments and repair works on your motorcycle.

070-2213



## Unifilter

The Touratech Research & Development team used the Unifilter and since then have found no dust residue in the air filter box. Another advantage of the filter, made of high-tech foam, is the long service life. The filter is not thrown away when it's dirty but rinsed out, lubricated again and used time and time again. So you don't just take care of your engine but also your wallet.

632-0870





## Touratech Suspension WTE lowering -35 mm SET

### Yamaha Ténéré 700 (2019-)

This World Travel Edition SET is perfect for reducing the seat height (-35mm) on the Yamaha Ténéré 700. Your Yamaha stays well tuned and ideally suited to touring use and the most Expedition demands. The Expedition - Set is fitted with a position sensitive damping system (PDS), which utilises a second damping piston to provide hydraulic protection against bottoming out. The progressive fork springs are perfectly matched to the fork on the Yamaha T7. They make the fork better suited to the demands of motorcycle touring. You will also experience a significantly improved response and greater reserves in extreme situations.

#### Facts at a glance:

- This Suspension SET is configured and adjusted ready for use based on our experience with the Yamaha Ténéré 700.

- The parameters are: vehicle weight / shock absorber pivot point / design constraints / test rides.
- With this SET, the rear and front area of the motorcycle are adjusted and in perfect balance.

To ensure that the motorbike stands securely after lowering, we recommend shortening the side stand. The basic setup fitted here is designed for riders up to 100 kg including luggage. Modifications are possible for a heavier rider (more than 100 kg) and/or if the bike is usually ridden with a passenger / with luggage. In this case, we individually modify the shock absorber to meet your needs.

Please fill out our suspension check form and send it back to us.

#### Scope of delivery:

- Ready-to-mount shock absorber -35 mm
- Replacement springs for the original fork -35 mm
- Suitable fork oil
- General Operating License
- Mounting instructions / user manual ONLINE

**632-5866 Expedition**

**632-5867 Extreme**

If you have any further questions, we will be happy to advise you. Contact us.





## Touratech Suspension Cartridge Extreme

Putting it simply, the Touratech Suspension Cartridge Extreme is a suspension strut for the fork and the absolute top end in terms of suspension technology. The Closed Cartridge is installed into the original fork. This way the fork bridge / handlebar mount, brakes and wheel control and handlebar geometry are retained in full. No additional modifications to the fork are required. This Closed Cartridge is been developed perfectly for touring and riding with frequent and strongly differing loads and riding conditions or extreme requirements.

632-5875

632-5876 lowering appr. -35 mm



## Touratech Suspension shock absorber Type Extreme

The Touratech Suspension Extreme shock absorber ranks in the absolute premium class of suspension components. This Extreme shock absorber for the Ténéré 700 is perfectly suited to touring and riding with frequent dramatic changes in loading and riding conditions, and the most extreme demands. The Extreme shock absorber is fitted with a position sensitive damping system (PDS), which utilises a second damping piston to provide hydraulic protection against bottoming out. Even fully loaded with luggage under the most extreme off-road conditions, the bike will not bottom out and the shock absorber is protected against mechanical overload. Damping characteristics change depending on the road surface. When riding under most conditions, the shock absorber is comfortably adjusted for a less strenuous ride, before the PDS kicks in for the last portion of the shock absorber stroke.

632-5870

632-5871 lowering appr. -35 mm



## Touratech Suspension Level 2

Many advantages to other high-end brands! Touratech Suspension has been designed with profound expertise of the different types of motorbike models. We therefore understand the specific user and reliability requirements as no one else does. The shocks were developed for traction, comfort, dynamic safety, reliability and light weight. Every shock has been test driven with Touratech customers in mind. Detailed information on Touratech suspension and available variants can be found starting on page 596 !

632-5860 Level 2

632-5865 Level 2 lowering appr. -35 mm



### Progressive replacement springs for original shock absorber

This progressive replacement spring is a perfect match for the shock absorber on the Yamaha Ténéré 700. They make the shock better suited to the demands of motorcycle touring. You will also experience a significantly improved response and greater reserves in extreme situations.

632-5884



### Progressive replacement springs for fork and shock absorber

Full set by Hyperpro, the Dutch specialist for suspension products. The set includes replacement fork springs and a replacement spring for the shock absorber. The progressive springs have been designed to match the Yamaha Ténéré 700 perfectly, and offer a tremendous improvement in response and greater safety in extreme situations. Replacing the front and rear springs will lead to a significant improvement in your suspension system.

632-5881

### Progressive fork springs

These progressive fork springs are perfectly matched to the fork on the Yamaha Ténéré 700. They make the fork better suited to the demands of motorcycle touring. You will also experience a significantly improved response and greater reserves in extreme situations. The fork springs are made in Europe by Dutch suspension specialists Hyperpro.

632-5880

632-5882 -35 mm

### Lowering KIT about -35 mm with forksprings and reversing levers

632-5883 -35 mm





### Tank bag Ambato EXP

As we develop and offer the exclusive base plates and strong attachment kits for our robust tank bags for each specific vehicle, it is a given that a perfect fit with no play at all should be achieved!

The Ambato EXP is also notable for the expansion option with an all-round zipper; small items can easily be stored under the adjustable elastic strap on the back.

Thanks to the water-repellent cable hole, it's now easy to charge a mobile phone in the tank bag -plus the side pockets have an expansion pleat, which means there's even more room inside them than you would think.

Size: (L x W x H) approx. 30 x 15 x 19/26 cm

Volume: approx. 7/10 litres

632-5800



### Tank bag Ambato Pure

This minimalist tank bag is a practical, well thought out piece of equipment that represents outstanding value for money. Flatter in shape and with fewer adornments, this model is suitable for all kinds of uses. For instance, it provides enough space for a day trip, can hold documents, a mobile phone, wallet and drinks on the way to a city sightseeing tour and is also the preferred choice for off-road riding as it doesn't restrict the rider's movements while standing or affect the bike's handling.

Size: (L x W x H) approx. ca. 30 x 15 x 19 cm

Volume: approx. 7 litres

632-5802





## Handlebar bag IBARRA Smart

Practical storage space and waterproof smart-phone holder - always within reach!

The highlight of our "Ibarra Smart" is the waterproof compartment for all common smartphones (up to approx. 9x16 cm). The fully sealed foil offers an optimal view of the screen and even allows the operation of most smartphones.

The mobile phone is inserted from the inside. Thanks to a small opening you can connect your charging cable.

Under the lid there is a large, weatherproof main compartment (approx. 2.4 litres) for first aid kits, high-visibility vests or sunglasses. A further, smaller compartment allows quick access to important documents and other small items. The yellow lining helps you to find the contents of the bag more easily.

A key feature is that our bag doesn't in any way restrict the rider's movements or affect control of the bike. The use of certified Cordura guarantees highest material quality.

Dimensions: (L x W x H) approx. 33/17 x 8 x 13 cm

Volume: approx. 2.4 litres

055-1285



## Bags AMBATO for crash bars

632-5162 / 5163 (1 pair)

When you're planning a short trip out on your motorbike, it's often tricky to know where to put your map, something to drink, your waterproofs, a spare pair of gloves, even something to clean your glasses with. Touratech has the solution in the shape of bags for the Touratech crash bars. They have just the right amount of space, especially for those little things.

Size (L x W x H): approx. 20 x 6 x 27 cm

Capacity: approx. 1,5 litres each side

632-5820



## Handlebar bag IBARRA

A wide opening water-repellent dust-proof zip provides easy access to a large main compartment. A key feature is that our bag doesn't in any way restrict the rider's movements or affect control of the bike.

045-5827



## Luggage rack XL instead of pillion seat

### Yamaha Ténéré 700

Useful accessories for the solo rider.

Our luggage rack XL for the Ténéré 700 allows, through numerous cut-out areas and strap loops, the simple and safe lashing and transport of almost any kind of luggage.

The luggage rack XL is simply mounted in place of the pillion seat. The forward-shifted position of the load has a positive effect on the riding dynamics and handling of the motorcycle. The system allows you to transport luggage without additional pannier racks, etc. This design ensures that the narrow silhouette of the Ténéré is maintained despite the luggage. Due to the special shape of the rack you can even reach the original grasps below the pillion seat without any obstacles.

Easy and uncomplicated to use - because the original pillion seat locking mechanism is retained, this solution enables ultra-quick changes between the pillion seat and luggage rack.

Made of 4 mm thick, black anodized aluminum, the luggage rack XL is also visually a full replacement for the pillion seat.

The unsightly „hole“ under the seat is thereby closed by a discreet aluminum plate, to which the robust stainless steel hooks are attached for secure fastening.

By attaching via the mechanism of the pillion seat, the luggage rack is secured to the vehicle with the ignition key. Simply click and go. A product for all who want to be flexible!

632-5457





# ZEGA

## Topcase / Luggage rack, stainless steel

A special bracket construction which is attached via the 4 available screw attachment points, provides extremely high stability and loading. Your luggage is secured safely, even under the most arduous conditions! In addition, the passenger hand grips are part of the carrier.

632-5455

632-5456 black



Matching topcases can be found starting on page 472!



## Stainless steel pannier rack

Touratech's stainless steel pannier rack for the T7 is a sturdy rack designed to take Touratech ZEGA Evo, ZEGA Pro, ZEGA Pro2 and ZEGA Mundo cases. This is the perfect case system for extended touring. Made of 18 mm stainless steel tubing, this non-rusting system matches the appearance of the Ténéré frame and guarantees extra high stability even off the beaten track. Fitted as closely as possible to the vehicle frame using existing attachment points.

- Made of 18 mm stainless steel tube
- Also suitable for tough off-road use
- No restrictions to pillion

Stainless steel

632-5555

Stainless steel black

632-5560



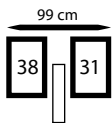

# ZEGA MUNDO

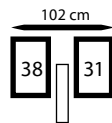
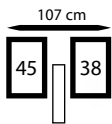

# ZEGA PRO

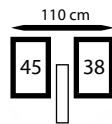

More information  
about ZEGA cases  
from page **>436**

## ZEGA aluminium pannier system

The aluminium pannier system again has a very robust construction. We have tried to bring the pannier racks and the panniers as close as possible to the motorcycle. Numerous tests have already been performed in order to ensure that the entire development satisfies the required demands.

The rack is made of 18 mm steel tubing and is attached to existing mounting points using special fixing clips and reinforcing pieces. Pillion comfort not restricted in any way. Enhances the enduro and touring appearance.

Pannier system with:	stainless steel rack	stainless steel rack black
ZEGA Mundo 31/38 L	632-6130	632-6180
ZEGA Pro 31/38 L	632-5730	632-5780
ZEGA Pro AND-S 31/38 L	632-5731	632-5781
ZEGA Pro AND-Black 31/38 L	632-5732	632-5782

Pannier system with:	stainless steel rack	stainless steel rack black
ZEGA Mundo 38/45 L	632-6135	632-6185
ZEGA Pro 38/45 L	632-5735	632-5785
ZEGA Pro AND-S 38/45 L	632-5736	632-5786
ZEGA Pro AND-Black 38/45 L	632-5737	632-5787



# ZEGA EVO



## ZEGA Evo aluminium pannier system

The ZEGA Evo, like all Touratech panniers before it, was not developed as an isolated product but was intended from the outset to be part of a luggage system. The outstanding practical benefits are the result of the unique combination of an elegant and indestructible pannier, an ingenious fastening mechanism and a terrain-immune rack made of 18 mm thick stainless steel tubes.

	stainless steel rack	stainless steel rack black
AND-S 31 / 38 L	632-6831	632-6881
AND-Black 31 / 38 L	632-6832	632-6882
AND-S 38 / 45 L	632-6836	632-6886
AND-Black 38 / 45 L	632-6837	632-6887

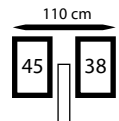
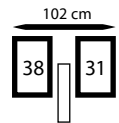



# ZEGA EVO X

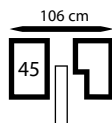
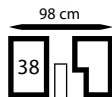

## ZEGA Evo X special systems

A typical feature of the special system is the recess on the right-hand pannier that allows it to nestle snugly against the exhaust. The panniers are positioned closer to the bike's centreline, the overall width is reduced, and the system as a whole appears more balanced thanks to the symmetrical pannier lids. Made from stainless steel, the sturdy pannier racks are scratch and rust resistant.

Special system with:	stainless steel rack	stainless steel rack black
ZEGA Evo AND-S 38/38 litres	632-6816	632-6866
ZEGA Evo AND-Black 38/38 litres	632-6817	632-6867
ZEGA Evo AND-S 45/45 litres	632-6826	632-6876
ZEGA Evo AND-Black 45/45 litres	632-6827	632-6877

# THE OTHER SIDE

Next on Martin Leonhardt's agenda - having worked his way, on remote routes, down as far as southern Italy - is the other side of the Adriatic: the Western Balkans, a paradise for adventure riders.

Text and photos: Martin Leonhardt





STORY

It's with a somewhat queasy feeling that I leave the ferry that brought me from Bari to Durrës in Albania. I'm neither familiar with the languages nor with the way of life in the countries that now lie ahead of me. But my concerns evaporate shortly after my arrival. Like everywhere else in the world, the best way to get along in the Balkans is to be open and smile.

From Durrës, I follow the coastal road south to Ksamil. Here I leave the coastal road behind me and head for the Hotova-Dangell National Park, where I get my first taste of winding gravel roads. The stones are coarse, and it definitely takes some skill to steer my Triumph Tiger safely over these bumpy trails. I never ride across the numerous suspension bridges without testing their load-bearing capacity beforehand.

SH71 leads north past the mighty Moglicë dam. I'm amazed to be riding through these serpentines on a perfect asphalt road. Later, the view opens to reveal a valley, kilometres wide, which reminds me of canyon landscapes in the USA. I would never have expected there to be such enormous dimensions here, which is why I'm already saving this section of the journey as an absolute insider tip. I don't meet a single other motorcyclist all day. In complete solitude, I follow my course north via Elbasan to Lake Ohrid.





*Wild camping in the solitude of the mountains (above) Brand new asphalt in Albania (left) Mavrovo National Park North Macedonia (centre.) Street scene in Shkodra / Albania (right)*







*Forest trails criss-cross the Sharri Mountains in Kosovo (left)*

*Soviet scrap in North Macedonia (centre)*

*Lonely track in the mountains of Albania (below)*



STORY

Crossing the border into North Macedonia is somewhat difficult. Since I've only met extremely friendly people so far, I'm surprised by the grumpy tone of the customs officials.

Before I set off through the Galičica National Park towards Kruševo, I stock up with a few Macedonian denars. Around Kruševo, I undertake numerous discovery tours and notice that North Macedonia is even more colourful than its neighbour Albania. Old tractors and cars from Soviet times are as much a part of everyday life here as mosques, shisha bars and tea rooms. Dilapidated factory buildings also add a touch of communism to the cities - otherwise only seen in countries like Cuba.

I visit the Treskavec monastery, whose ramshackle walls date back to the 12th century, and ride to the second highest mountain in the country, the 2747 metre high Titov Vrv. Immediately after the turbulent town of Tetovo, I find myself in a vast steppe

landscape with trails that again cost me quite a bit of energy. I spend a wonderful night with a view of the Milky Way, sleep contentedly and hike up to an abandoned stone tower on a peak to watch the sun rise. The view from there stretches far across the Balkan Mountains to Kosovo - somewhere I'll also be heading for on this trip.

Before that, however, I visit the capital city, Skopje, which can certainly be described as bizarre. Reminiscent of ancient Rome, one monumental statue follows the next. A historic stone arch bridge leads from the Muslim part of the city to the Christian part.

At the border to Kosovo, I receive a friendly welcome and, as a welcoming gift for the Tiger, there is free insurance.

Seeing the Sharri Mountains once again from the northern side inspires me anew. Here, however, more spectacular mountain formations, are only to







*Valamara Mountains in south-eastern Albania (left)*

*Rough-treaded tyres are recommended already in dry conditions... (above)*

*A sat nav does a good job on remote routes (below)*



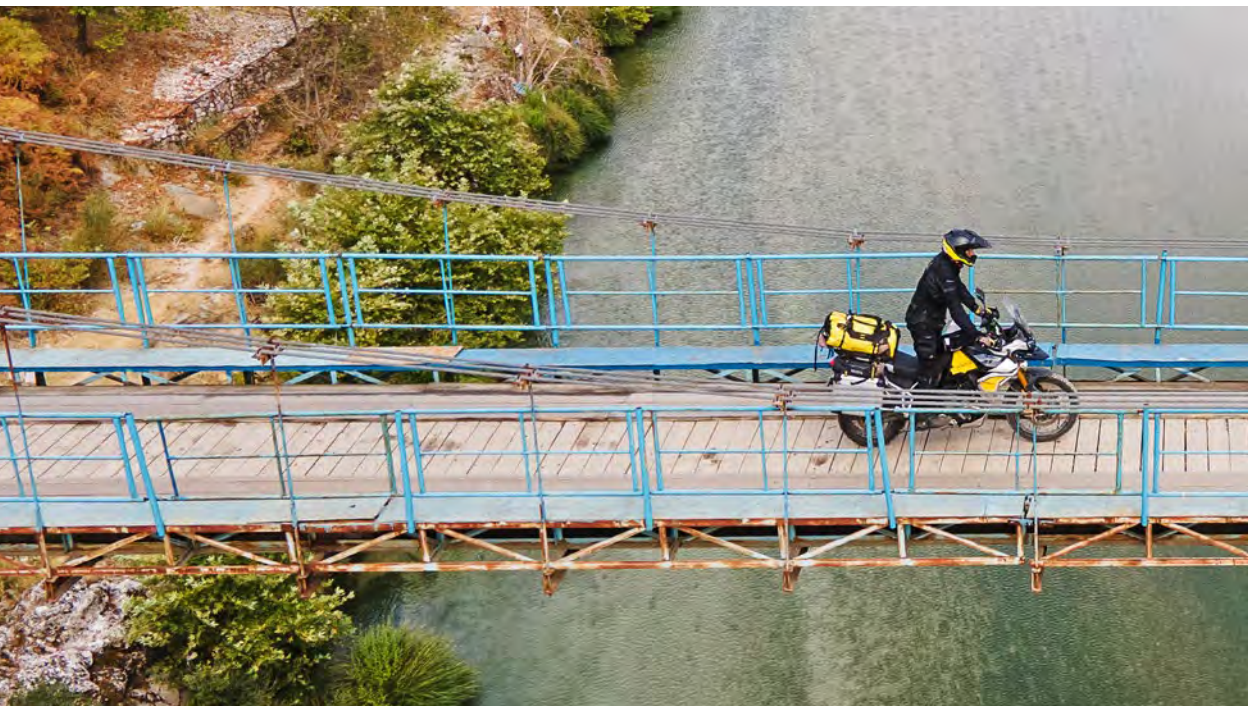

be found in Bjeshkët e Nemuna National Park. The landscapes there are characterised by steep canyons. Any potential circular routes, not to mention a crossing to Albania or Montenegro, are reserved for sporty mountain bikers or hikers. Motorised off-road junkies get their money's worth on the narrow, winding gravel tracks into the mountains.

Almost wistfully, I leave Kosovo after only five days and travel back to Albania, to the Valbona Valley. Despite the comparatively strong tourism, the area has not lost its lovely charm.

At the end of the trip, I want at least one more look at the sea. That's why I take what is probably the most continuously winding road I've ever ridden along in my life, the SH22 and SH5, towards the mouth of the Buna River. I actually find a place

for my tent on the beach. This night is a welcome change from the mainly mountain dominated tour. Accordingly, the ride over the Leqet e Hotit Pass is a worthy conclusion to this journey.

**Information on the author's other journeys can be found on his website at [www.martin-leonhardt.de](http://www.martin-leonhardt.de)**



*Bridge into Hotova-Dangell National Park (above)  
In the border region of Kosovo / North Macedonia (below)*





ZEGA Panniers

p. 442



Pannier frames

p. 470

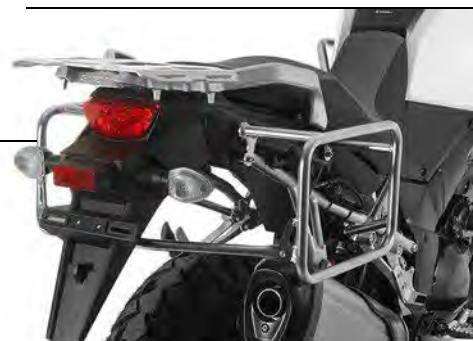

# PANNIERS

KOFFER

COFFRES

VALIGIE

MALETAS



ZEGA Topcases

p. 472



ACCESSORIES

p. 480





# ALUMINUM CASES

## ADVENTURE ALL INCLUSIVE

Aluminum cases are extremely robust, highly practical and look pretty good, too. Long gone are the days when only adventure-seeking travelers decided to go with this type of luggage transportation on motorcycles.

The advent of the travel enduro revolutionized the way in which motorcyclists discovered the world. Real off-road capabilities combined with more than useful long-distance features suddenly made it possible to reach the far-off, secluded regions of this planet without demanding superhuman efforts. It is certainly no exaggeration when one speaks of a downright movement of enduro travelers which started at the end of the 70's, early 80's, with the advent of legendary models such as the Yamaha XT 500 and soon later the BMW R 80 G/S.

The new class of motorcycles allowed higher speeds in difficult terrain, large tanks provided a huge range in distance in areas without provisions. All these factors made it necessary to completely rethink the subject of luggage.

The conventional plastic cases were neither able to withstand a longer trip away from paved roads in terms of robustness, nor were they able to offer adequate volume for provisions, spare parts and luggage for the new-found growing autonomy of motorcycles.

The only (affordable) material offering the required strength at a justifiable weight, was aluminum. Professional expeditions have already been using containers made of this versatile light-weight material for prolonged periods, however, these boxes had dimensions which were totally unsuitable for use with motorcycles.

Traveling motorcyclists of this generation received no support at all from the accessory industry. So it is not surprising that construction drawings for making aluminum cases were traded as eagerly at the various meetings as new routes through Central Sahara.

Photo: Ely Woody



Depending on the craftsmanship and imagination of the designer, these early self-made aluminum boxes resulted in some curious designs, many of them not even surviving the first part of the trip on the motorways. As part of the natural selection process, central criteria evolved which still apply in principle to today's aluminum cases as being suitable for practice.

This includes a more or less cube-shaped form to give optimal utilization of the interior, as well as a tight-

sealing lid. The robust exterior skin also had to survive hefty impact, as well as allowing repairs with basic means en route. and last not least, mounting to the carrier should not become loose, even after thousands of kilometers of riding tracks.

Water-proof and indestructible high quality aluminum cases with comfortable handling and unbeatable diversity are the perfect companions for all manner of motorcycle travelers.

Photo: Look around the globe





# WHY ALUMINUM CASES?



**WATERPROOF**



**REPAIRABLE**



**TOP LOADER**



**TAMPER-PROOF**



# YOUR ADVANTAGES



ALL-TERRAIN  
AND ROBUST



COMPATIBLE WITH  
ACCESSORIES



VARIABLE



ADVENTURE LOOK





# PERFECTION IN ALUMINUM

## TOURATECH ZEGA ALUMINUM CASES

Touratech has pooled its know-how from three decades of travel experience to create the most innovative luggage system for motorcycles. The aluminum cases of the Zega family and its three product ranges represent a unique synthesis of functionality, durability and design.

The travel professionals at Touratech have experienced the evolution of the aluminum case from close up and have been instrumental in its design for a good two decades. Not only does the functionality and design of the Zega cases reflect own travel experience over thousands of kilometers, the input of countless motorcycle adventurers traveling the tracks of this world with the aluminum boxes from Niedereschach, all add to the continuous improvement of these high-end cases. Maximum robustness, practicability under a host of conditions and a timeless, elegant look are distinguish the Zega cases from Touratech.

The material used for the case body is 1.5 mm thick aluminum sheeting. The alloy, which was developed

specifically for Touratech, offers highest strength values. State-of-the-art processing centers with computer-guided tool machines are used for cutting, shaping and joining at smallest tolerances. These technologies, some of which are exclusive to Touratech, guarantee the precision required to give maximum reliability.

Specially drawn profiles according to Touratech specifications not only give the body and lid impressive stiffness, but also ensure that the Zega cases are dust and waterproof. The robustness of these Touratech aluminum cases not only makes them popular as indestructible companions on track roads. In urban areas, too, the lockable boxes have proven to be a safe storage compartment for a variety of luggage pieces and even helmets.

In addition, the Zega cases are designed as top loaders and can be loaded with unbeatable simplicity. As needed, the lid can be removed completely or flipped open at the front or back. High quality fittings and numerous smart details ensure maximum user comfort.

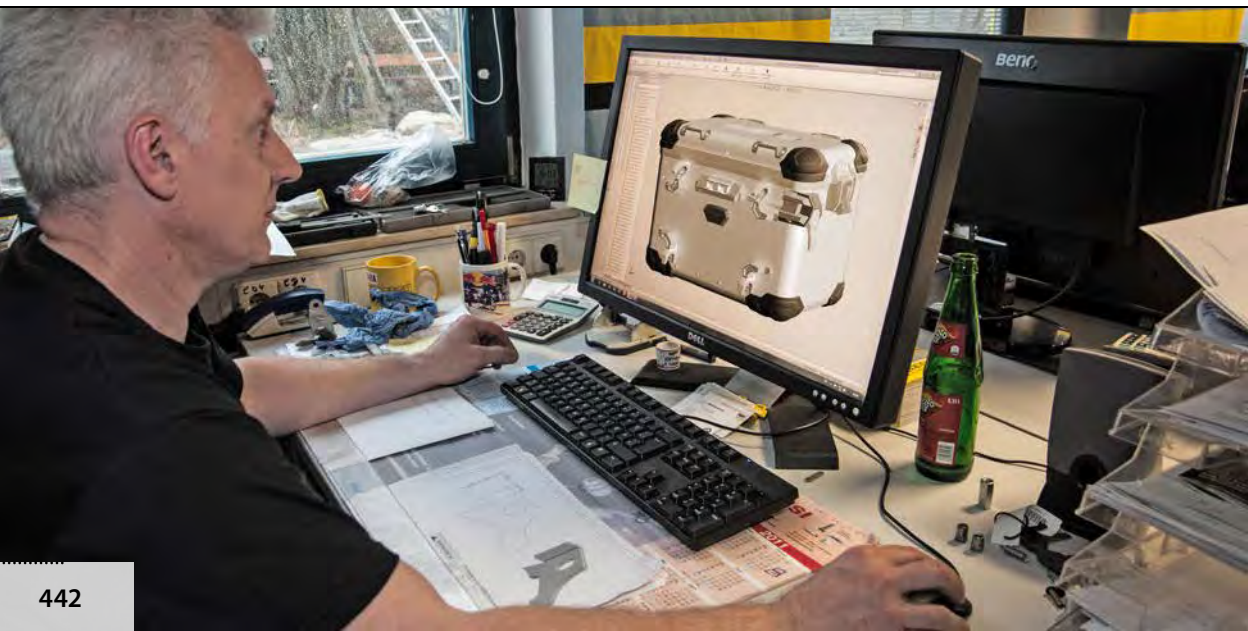

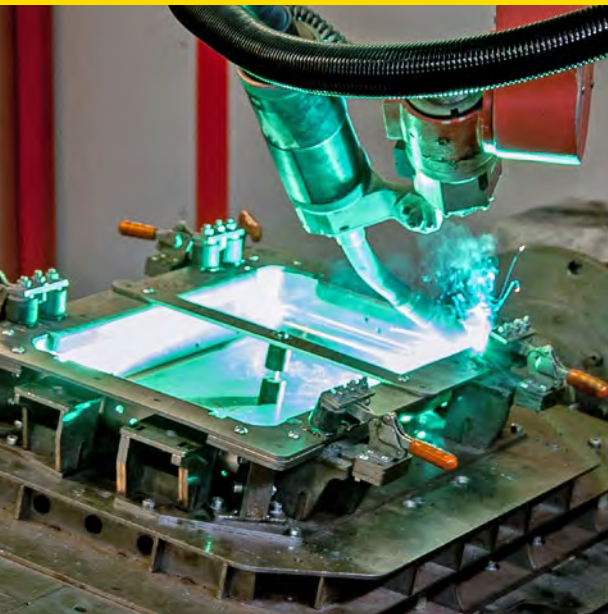

Touratech has developed a substantial range of accessories to accompany the Zega cases. Holders for additional canisters, bottles or first-aid kits are available, as are grips and loops, complete camping sets or high-quality textile bags and interior fittings. and even the case is amazingly versatile in its use: as table, stepladder, mounting support - the spectrum of uses of the indestructible boxes is only really limited by the creativity of the use.

Depending on the requirements and space available on the vehicle, the cases of the Zega, Mundo, Zega Pro and Zega Pro2 + EVO series are available in different sizes. In addition, the Pro designs offer a choice between

a natural aluminum look and two more refined variants with galvanized surfaces in silver or black.

Touratech Zega cases are mounted easily and securely for travel on tracks to indestructible model-specific stainless steel carriers using a thousand-fold proven mounting system. Even greater comfort is provided by single-hand operation and exclusive to the Zega EVO system.

**Touratech Zega aluminum cases - optimized quality for individual motorcycling adventure over millions of kilometers.**



# TOURATECH ZEGA ALU CASE...



**MADE IN EU  
(GERMANY)**



**ROBUST**



**SAFE**



**TESTED**

## ...READY FOR YOUR ADVENTURE



**TIGHT:  
DUST- AND  
WATERPROOF**



**ACCESSORIES:  
NUMEROUS  
OPTIONS**



**THREE SIZES:  
31 LITRES  
38 LITRES  
45 LITRES**



**FOR VIRTUALLY ALL  
TRAVEL ENDUROS**





# ZEGA EVO



Detailed information  
from page 461.

## ALL TOURATECH ZEGA ALU CASE VARIANTS OFFER AS STANDARD:

- Made in Germany
- Waterproof
- Dustproof
- Extremely robust
- Made of 1.5 mm aluminum
- All-terrain
- Compatible with accessories
- Available in 3 sizes

TOURATECH ZEGA ALUMINUM CASES –  
OPTIMIZED QUALITY FOR INDIVIDUAL  
MOTORCYCLING ADVENTURE  
OVER MILLIONS OF KILOMETERS.

# ZEGA MUNDO

THE PURIST



Detailed information  
from page 448.

- Clear technical design
- Thousand-fold proven mounting system (optional)

• **pannier systems**  
from page 450



Detailed information  
from page 454.

# ZEGA PRO

THE CLASSIC OPTION

- Anodized variants
- Thousand-fold proven mounting system (optional)

• **pannier systems**  
from page 456





# ZEGA MUNDO

## ZEGA Mundo – Back to the roots

The ZEGA Mundo follows the tradition of the legendary ZEGA Case. A simple, robust and nicely designed aluminum case that handles all assignments, ranging from everyday to adventure, with flying colors.

The development of the ZEGA Mundo focused one hundred percent on pure functionality. Practical suitability, robustness and technically clean design are all united in this aluminum case.

To obtain joints with maximum strength, the indestructible body is made of 1.5 mm thick aluminum sheeting and riveted to the base, which is drawn from a single piece of aluminum, with special rivets. This concept conveys the case with a solid plus in terms of rigidity. In addition, the integrated, extra large-dimensioned silicone tape ensures a lifelong waterproof seam. The same applies to the specially formed profile which forms the upper part of the case body. It reinforces the case and the integrated sealing lip, which fits the lid profile with absolute precision, ensures completely waterproof closure.

Constructional design and the choice of materials pool the experience of over two decades of adventures and expeditions on the world's toughest tracks. The materials can withstand hours and days of vibration on washboard tracks as well as as load peaks when rapidly crossing through bumps. High tensile and penetration strength of the material ensure maximum resistance when encountering obstacles or - in the worst case - taking a fall.

Manufactured in the Niedereschach facility, the Mundo benefits from the advanced technologies which are also applied to the ZEGA Pro and ZEGA Pro2 variants. This is where the precision of computer-guided machines and the profound know-how of highly trained skilled employees meet.

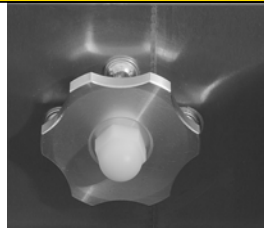
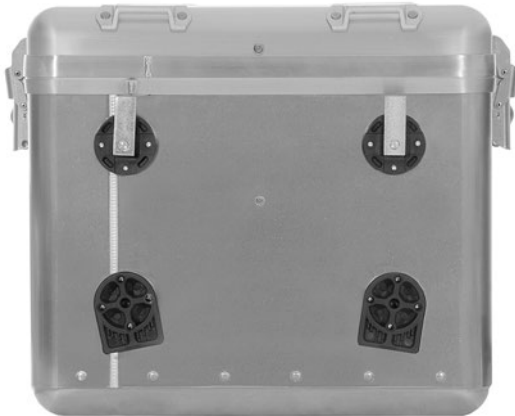



Like the other cases of the ZEGA family, the Mundo is equipped with high quality, lockable stainless steel fittings. These not only allow the complete removal of the lid, they can also serve as hinges, so that the case lid can be opened to the front or rear as required.

The case is secured to the model-specific designed track-proof carriers, made from 18x2 steel tubing, using the thousand-fold proven Touratech system. The large, originally knurled securing nuts in the case interior are now shaped ergonomically in the Mundo to allow even easier handling. Fast mounting and absolutely play-free fit, even after thousands of

kilometers on the track, have made this system the first choice in travel to faraway destinations.

But the new Mundo can do a lot more than simply carrying luggage reliably from A to B. The comprehensive ZEGA range of accessories turns the Mundo into an individual transport system.

The ZEGA Mundo is available in three sizes ranging from 31, 38 to 45 liters volume. And last but not least, the clean esthetics of the Mundo make it a timeless, beautiful piece of European craftsmanship.



31L



38L



45L



## ZEGA Mundo Alucase with Mounting Kit

050-3810 31 litres

050-3820 38 litres

050-3830 45 litres



# ZEGA MUNDO

## PANNIER SYSTEMS



Delivery includes:

2 x aluminium panniers  
ZEGA Mundo

1 x pannier rack including  
mounting hardware

BMW R 1250 / 1200 GS / ADV  
(2013- / 2014-)

stainless steel rack

stainless steel rack  
(black)

width

31 / 38 L

045-6130

045-6180

96 cm

38 / 45 L

045-6135

045-6185

104 cm

BMW R 1200 GS / ADV (-2012 / -2013)

31 / 38 L

044-6130

96 cm

38 / 45 L

044-6135

104 cm

BMW R 1150 / 1100 / 850 GS

38 / 45 L

040-6135

98 cm

BMW F 850 GS / 750 GS

31 / 38 L

082-6130

082-6180

98 cm

38 / 45 L

082-6135

082-6185

104 cm

BMW F 800 / 700 / 650 GS

31 / 38 L

048-6130

106 cm

31 / 38 L

048-6180  
(regular steel)

106 cm

BMW G 650 / F 650 GS / Sertao

31 / 31 L

300-6100

94 cm

38 / 38 L

300-6110

102 cm

45 / 45 L

300-6120

110 cm



Accessories ZEGA CASE  
p. 480

**Integral lock (1 piece)**

050-0870

**Integral locks set with 2 equivalent locks**

050-0872

**Integral locks set with 4 equivalent locks**

050-0874

**Integral lock for Rapid Trap**

050-0871

**Integral locks set for release catches ZEGA Pro2**

050-3300



## Locks for ZEGA Panniers

ZEGA Pro / Pro2 / Mundo

These installation locks are only suitable for ZEGA Pro2 / ZEGA Pro / ZEGA Mundo and can be installed without drilling/filing.

If you require a certain key number, please enter it in step 7 of the order transaction.



# ZEGA MUNDO

	stainless steel rack	stainless steel rack (black)	width
<b>Honda CRF 1100 L Africa Twin (-2021)</b>			
31 / 38 L	403-6130	403-6180	100 cm
38 / 45 L	403-6135	403-6185	108 cm
<b>Honda CRF 1100 L Africa Twin (2022-) / ADV Sports</b>			
31 / 38 L	403-7130	403-7180	101 cm
38 / 45 L	403-7135	403-7185	109 cm
<b>Honda CRF 1000 L Africa Twin (-2017)</b>			
31 / 38 L	402-6130	402-6180	99 cm
38 / 45 L	402-6135	402-6185	107 cm
<b>Honda CRF 1000 L Africa Twin (2018-) / ADV Sports</b>			
31 / 38 L	402-7130	402-7180	99 cm
38 / 45 L	402-7135	402-7185	107 cm
<b>KTM 1290 Super ADV (2021-)</b>			
31 / 38 L	373-6130	373-6180	105 cm
38 / 45 L	373-6135	373-6185	113 cm
<b>KTM 1290 Super ADV (-2020) 1190, 1090, 1050 ADV / R</b>			
31 / 38 L	371-6130	371-6180	99 cm
38 / 45 L	371-6135	371-6185	107 cm
<b>KTM 890 / 790 ADV / R</b>			
31 / 38 L	372-6130	372-6180	99 cm
38 / 45 L	372-6135	372-6185	107 cm
<b>KTM 690 Enduro/R (-2017)</b>			
31 / 38 L	370-6130		93 cm
<b>KTM 390 ADV</b>			
31 / 38 L	375-6130		94 cm

Triumph Tiger 900	stainless steel rack	stainless steel rack (black)	width
31 / 38 L	421-6130	421-6180	98 cm
38 / 45 L	421-6135	421-6185	106 cm
Triumph Tiger 800			
31 / 38 L	420-6130	420-6180	99 cm
38 / 45 L	420-6135	420-6185	107 cm
Yamaha XT 1200 Z/ZE			
31 / 38 L	046-6130	046-6180	98 cm
38 / 45 L	046-6135	046-6185	106 cm
Yamaha Ténéré 700			
31 / 38 L	632-6130	632-6180	96 cm
38 / 45 L	632-6135	632-6185	104 cm
Yamaha MT-09 Tracer (2015-2017)			
31 / 31 L	630-6100	630-6150	89 cm
38 / 38 L	630-6110	630-6160	97 cm





# ZEGA PRO



AND-S

AND-Black

Whether jungle expedition, desert adventure or driving through the continuous rain of central Europe: our aluminium ZEGA cases have proved their worth in countless motorbike adventures, even under the most extreme conditions, and shown themselves to be indestructible and reliable companions.

And now we are delighted to present ZEGA Pro, the revolutionary development that complements our popular touring panniers. Just as versatile as the ZEGA case, beautifully shaped, strong, and with plenty of accessories, it will fit (with the appropriate mounting sets) almost any rack, and is also available in three different sizes and an anodised version.

In a modern design and state-of-the-art construction, our developers have come up with a veritable masterpiece in the ZEGA Pro. Light and yet sturdy, the case is available in a 31, 38 or 45 litre version, made entirely of 1.5-mm aluminium, water- and dust-proof, and manufactured to the highest standards - no way were we going to settle for a basic plastic construction that was simply jazzed up with a few bits of moulded aluminium!

The lid and base of the ZEGA Pro are welded, which achieves the maximum rigidity of the connections, and the base and outer shell have high quality rivets (no cheap studs for us - or you!). You'll find no leaky welded seams along the edges.

The anodised version of the ZEGA Pro doesn't just shine in its fabulous natural aluminium look, but also prevents rubbing inside the case. The ultra thick, high quality anodised layer offers very special protection for the surface and helps to prevent discoloration.



High quality silicone seals ensure that the contents of this case are protected as well as possible.

The highly robust protective strip along the carcass is screwed on, and so is easily replaced when necessary - perhaps after a fall. The same applies to the strong protective corners on the lid, which comes off completely or can be opened just from one side - the catches double as hinges.

The ZEGA Pro appeals not only for its technology and workmanship, but also for the many clever detail solutions and the modern protected design - the rounded lines of the item really do catch the eye. Thus, for instance, a clever handle can be added to the lid. The four attachment eyes rise only slightly above the surface of the case, so it also makes an ideal seat.

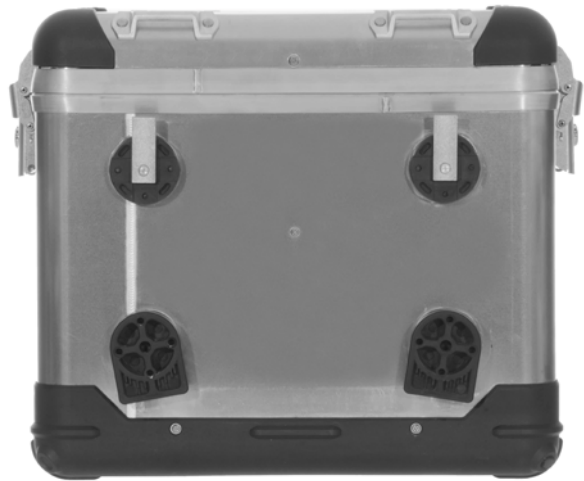

Some of the other benefits of the ZEGA Pro are that it is easy to open to retrieve a luggage roll and our extensive range of accessories; they will even accommodate a helmet - and the 45-l version will even take a big one. Vehicle-specific special systems, e.g. for the BMW R 1200 GS, are also available. The clever touches of the ZEGA Pro include the ingenious lock system, which is strong and reliable yet easy to operate.

### The advantages at a glance:

- automatic locking prevents the catches from opening accidentally
- fitted locks can be replaced or added later without drilling or filing
- simultaneously locking fitted locks are available at no extra charge; also available with the same locks as navigation brackets and oil plugs.



### ZEGA Pro Alucases

050-0710	31 litres
050-0712	31 litres - AND-S
050-0713	31 litres - AND-Black
050-0720	38 litres
050-0722	38 litres - AND-S
050-0723	38 litres - AND-Black
050-0730	45 litres
050-0732	45 litres - AND-S
050-0733	45 litres - AND-Black

Locks for ZEGA Panniers

p. 484



# ZEGA PRO

## PANNIER SYSTEMS

Delivery includes:

2 x aluminium panniers ZEGA Pro

1 x pannier rack  
including mounting hardware

Accessories ZEGA CASE  
p. 480



BMW R 1250 / ADV   1200 GS (LC) (2013-) / ADV (2014-)	stainless steel rack	stainless steel rack (black)	width
31 / 38 L	045-5730	045-5780	96 cm
AND-S 31 / 38 L	045-5731	045-5781	96 cm
AND-Black 31 / 38 L	045-5732	045-5782	96 cm
38 / 45 L	045-5735	045-5785	104 cm
AND-S 38 / 45 L	045-5736	045-5786	104 cm
AND-Black 38 / 45 L	045-5737	045-5787	104 cm

BMW R 1200 GS (AC) (-2012) / ADV (-2013)			
38 / 45 L	052-3007		104 cm
AND-S 38 / 45 L	052-3008		104 cm
AND-Black 38 / 45 L	052-3010		104 cm

BMW R 1150 / 1100 / 850 GS			
38 / 45 L	052-3181		98 cm
AND-S 38 / 45 L	052-3182		98 cm
AND-Black 38 / 45 L	052-3183		98 cm

BMW F 850 GS/ ADV/750 GS			
31 / 38 L	082-5730	082-5780	98 cm
AND-S 31 / 38 L	082-5731	082-5781	98 cm
AND-Black 31 / 38 L	082-5732	082-5782	98 cm
38 / 45 L	082-5735	082-5785	104 cm
AND-S 38 / 45 L	082-5736	082-5786	104 cm
AND-Black 38 / 45 L	082-5737	082-5787	104 cm



BMW F 800 / 700 / 650 GS	stainless steel rack	steel rack (black)	width
31 / 38 L	048-5730		106 cm
31 / 38 L		052-3101	106 cm
AND-S 31 / 38 L	048-5731		106 cm
AND-S 31 / 38 L		052-3102	106 cm
AND-Black 31 / 38 L	048-5732		106 cm
AND-Black 31 / 38 L		052-3103	106 cm

BMW G 650 / F 650 GS / Sertao			
31 / 31 L	300-5700		94 cm
AND-S 31 / 31 L	300-5701		94 cm
AND-Black 31 / 31 L	300-5702		94 cm
38 / 38 L	300-5710		102 cm
AND-S 38 / 38 L	300-5711		102 cm
AND-Black 38 / 38 L	300-5712		102 cm
45 / 45 L	300-5720		110 cm
AND-S 45 / 45 L	300-5721		110 cm
AND-Black 45 / 45 L	300-5722		110 cm

Honda CRF 1100 L Africa Twin (-2021)	stainless steel rack	stainless steel rack (black)	width
31 / 38 L	403-5730	403-5780	100 cm
AND-S 31 / 38 L	403-5731	403-5781	100 cm
AND-Black 31 / 38 L	403-5732	403-5782	100 cm
38 / 45 L	403-5735	403-5785	108 cm
AND-S 38 / 45 L	403-5736	403-5786	108 cm
AND-Black 38 / 45 L	403-5737	403-5787	108 cm

Honda CRF 1100 L Africa Twin (2022-) / ADV Sports			
31 / 38 L	403-6730	403-6780	101 cm
AND-S 31 / 38 L	403-6731	403-6781	101 cm
AND-Black 31 / 38 L	403-6732	403-6782	101 cm
38 / 45 L	403-6735	403-6785	109 cm
AND-S 38 / 45 L	403-6736	403-6786	109 cm
AND-Black 38 / 45 L	403-6737	403-6787	109 cm



# ZEGA PRO

# PANNIER SYSTEMS

## Honda CRF 1000 L Africa Twin (-2017)

	stainless steel rack	stainless steel rack (black)	width
31 / 38 L	402-5730	402-5780	99 cm
AND-S 31 / 38 L	402-5731	402-5781	99 cm
AND-Black 31 / 38 L	402-5732	402-5782	99 cm
38 / 45 L	402-5735	402-5785	107 cm
AND-S 38 / 45 L	402-5736	402-5786	107 cm
AND-Black 38 / 45 L	402-5737	402-5787	107 cm

## Honda CRF 1000 L Africa Twin (2018-)/ ADV Sports

31 / 38 L	402-6730	402-6780	99 cm
AND-S 31 / 38 L	402-6731	402-6781	99 cm
AND-Black 31 / 38 L	402-6732	402-6782	99 cm
38 / 45 L	402-6735	402-6785	107 cm
AND-S 38 / 45 L	402-6736	402-6786	107 cm
AND-Black 38 / 45 L	402-6737	402-6787	107 cm

## KTM 1290 Super ADV (2021-)

31 / 38 L	373-5730	373-5780	105 cm
AND-S 31 / 38 L	373-5731	373-5781	105 cm
AND-Black 31 / 38 L	373-5732	373-5782	105 cm
38 / 45 L	373-5735	373-5785	113 cm
AND-S 38 / 45 L	373-5736	373-5786	113 cm
AND-Black 38 / 45 L	373-5737	373-5787	113 cm

## KTM 1290 Super ADV (-2020) 1190, 1090, 1050 ADV / R

31 / 38 L	371-5730	371-5780	99 cm
AND-S 31 / 38 L	371-5731	371-5781	99 cm
AND-Black 31 / 38 L	371-5732	371-5782	99 cm
38 / 45 L	371-5735	371-5785	107 cm
AND-S 38 / 45 L	371-5736	371-5786	107 cm
AND-Black 38 / 45 L	371-5737	371-5787	107 cm

	stainless steel rack	stainless steel rack (black)	width
<b>KTM 890 / 790 ADV / R</b>			
31 / 38 L	372-5730	372-5780	99 cm
AND-S 31 / 38 L	372-5731	372-5781	99 cm
AND-Black 31 / 38 L	372-5732	372-5782	99 cm
38 / 45 L	372-5735	372-5785	107 cm
AND-S 38 / 45 L	372-5736	372-5786	107 cm
AND-Black 38 / 45 L	372-5737	372-5787	107 cm
<b>KTM 690 Enduro/R (-2017)</b>			
31 / 38 L	052-3301		93 cm
AND-S 31 / 38 L	052-3302		93 cm
AND-Black 31 / 38 L	052-3303		93 cm
<b>KTM 390 ADV</b>			
31 / 38 L	375-5730		94 cm
AND-S 31 / 38 L	375-5731		94 cm
AND-Black 31 / 38 L	375-5732		94 cm
<b>Triumph Tiger 900</b>			
31 / 38 L	421-5730	421-5780	98 cm
AND-S 31 / 38 L	421-5731	421-5781	98 cm
AND-Black 31 / 38 L	421-5732	421-5782	98 cm
38 / 45 L	421-5735	421-5785	106 cm
AND-S 38 / 45 L	421-5736	421-5786	106 cm
AND-Black 38 / 45 L	421-5737	421-5787	106 cm
<b>Triumph Tiger 800</b>			
31 / 38 L	420-5730	420-5780	99 cm
AND-S 31 / 38 L	420-5731	420-5781	99 cm
AND-Black 31 / 38 L	420-5732	420-5782	99 cm
38 / 45 L	420-5735	420-5785	107 cm
AND-S 38 / 45 L	420-5736	420-5786	107 cm
AND-Black 38 / 45 L	420-5737	420-5787	107 cm



# ZEGA PRO

Yamaha XT 1200 Z/ZE	stainless steel rack	stainless steel rack (black)	width
31 / 38 L	052-3611	046-5780	96 cm
AND-S 31 / 38 L	052-3612	046-5781	96 cm
AND-Black 31 / 38 L	052-3613	046-5782	96 cm
38 / 45 L	052-3614	046-5785	104 cm
AND-S 38 / 45 L	052-3615	046-5786	104 cm
AND-Black 38 / 45 L	052-3616	046-5787	104 cm

Yamaha Ténéré 700			
31 / 38 L	632-5730	632-5780	96 cm
AND-S 31 / 38 L	632-5731	632-5781	96 cm
AND-Black 31 / 38 L	632-5732	632-5782	96 cm
38 / 45 L	632-5735	632-5785	104 cm
AND-S 38 / 45 L	632-5736	632-5786	104 cm
AND-Black 38 / 45 L	632-5737	632-5787	104 cm



## Viva la Evolution!

Continuous EVOLUTION - under this motto we have further developed our ZEGA pannier systems and so the name of our latest aluminium pannier was clear from the start. The ZEGA Evo combines the robustness proven ten thousand times over with extra convenient handling - not least thanks to a completely new fastening system.

## Practical benefits and user-friendliness

The ZEGA Evo offers even easier mounting than the ZEGA Pro2, with an absolutely secure hold - even in tough off-road conditions! It thus combines optimum ergonomics and absolute comfort without sacrificing reliability.

With the new lid catches, we've retained the popular hinge function. This allows the lid to be opened from both sides or removed completely. The lid and base of the pannier are manufactured using a modern deep-drawing process, which eliminates the need for unattractive welding seams.

The stable connection between the outer shell and the base is ensured by the high-quality, waterproof special rivets. The lid has a tongue and groove

profile with an integrated silicone seal, which guarantees a watertight seal. The newly developed ventilation system relieves the pressure in or on the pannier if there's a change in altitude. This means you can open a pannier which you closed in the valley on the highest pass road. Like its predecessor, the ZEGA Evo is also made of the established 1.5 mm thick aluminium.

The ZEGA Evo is already equipped with practical accessory fixing pins. So you can easily attach the special ZEGA Evo accessory holders without drilling holes in your new case. As with the previous versions, the proven attachment eyes are installed as standard on the lid, so that you can attach special pannier lid bag or other objects to your ZEGA Evo securely. The pannier is easy to transport thanks to the carrying handle.

Whether silver or black anodised, the new ZEGA Evo also sets the standard for high-quality luggage solutions when it comes to design. The rounded, newly designed plastic corners are not only a decorative element. In the event of an accident, they protect not only the suitcase but also the driver from injury.



# ZEGA EVO





- 1 Newly designed plastic corners - protect driver and pannier in the event of an accident
- 2 Proven fixing pins - for ZEGA Evo accessory holder
- 3 Proven handle - for comfortable carrying
- 4 Newly developed fastening system - for easy mounting and secure hold on the pannier rack
- 5 Newly developed lockable one-hand locking system - for convenient and secure attachment to the pannier rack
- 6 Newly developed lockable lid catch- for convenient opening and closing from both sides, thanks to practical hinge function
- 7 Proven silicone seal - for a pannier that's dry on the inside, even in the pouring rain
- 8 Proven attachment eyes - for secure fastening of pannier lid bags and other soft luggage
- 9 Standard hooks on the inside of the lid - for attaching accessories (bags, nets)

## ZEGA EVO





## Newly developed fastening system

The core element of the ZEGA Evo is a completely newly developed and designed fastening system on the pannier racks which combines easy handling with secure hold. Your pannier remains safely attached to your motorcycle even if very high forces are at work. The mounting procedure is super simple, the locking mechanism is equipped with a safety lock which is active even

if you don't lock it, and handling is child's play even with the thickest gloves. Simply slide the hooks onto the rack and push the tension lever down until it clicks into place. The pannier can be additionally secured against theft with a lock on the rack. To remove, simply pull on the tension lever and lift the pannier from the rack. The mechanism also works in demanding conditions - dirt, sand, mud, etc.



## 31L

### ZEGA Evo - 31 litres, premounted

- 050-6016 AND-S right
- 050-6011 AND-S left
- 050-6017 AND-Black right
- 050-6012 AND-Black left



## 38L

### ZEGA Evo - 38 litres, premounted

- 050-6026 AND-S right
- 050-6021 AND-S left
- 050-6027 AND-Black right
- 050-6022 AND-Black left

## 45L

### ZEGA Evo - 45 litres, premounted

- 050-6036 AND-S right
- 050-6031 AND-S left
- 050-6037 AND-Black right
- 050-6032 AND-Black left



# ZEGA EVO

# PANNIER SYSTEMS



## Panniers as part of the luggage system

The ZEGA Evo, like all Touratech panniers before it, was not developed as an isolated product but was intended from the outset to be part of a luggage system. The outstanding practical benefits are the result of the unique combination of an elegant and indestructible pannier, an ingenious fastening mechanism and a terrain-immune rack made of 18 mm thick stainless steel tubes. Matching inner pannier bags and practical accessory holders round off the luggage system.

BMW R 1250 / ADV   1200 GS (LC) (2013–) / ADV (2014–)	stainless steel rack	stainless steel rack (black)	width
AND-S 31 / 38 L	045-6831	045-6881	96 cm
AND-Black 31 / 38 L	045-6832	045-6882	96 cm
AND-S 38 / 45 L	045-6836	045-6886	104 cm
AND-Black 38 / 45 L	045-6837	045-6887	104 cm
<b>BMW R 1200 GS (AC) (–2012) / ADV (–2013)</b>			
AND-S 31 / 38 L	044-6831		96 cm
AND-Black 31 / 38 L	044-6832		96 cm
AND-S 38 / 45 L	044-6836		104 cm
AND-Black 38 / 45 L	044-6837		104 cm
<b>BMW F 850 GS / ADV BMW F 750 GS</b>			
AND-S 31 / 38 L	082-6831	082-6881	96 cm
AND-Black 31 / 38 L	082-6832	082-6882	96 cm
AND-S 38 / 45 L	082-6836	082-6886	104 cm
AND-Black 38 / 45 L	082-6837	082-6887	104 cm



## ZEGA Evo lock set for 2 cases

These installation locks are especially suitable for ZEGA Evo and can be installed without drilling/filing. Set for both cases!

Scope of delivery:

- 1 x lock for case fastening left
- 1 x lock for case fastening right
- 4 x lock for case lock

050-6000



	stainless steel rack	stainless steel rack (black)	width
<b>Honda CRF 1100 L Africa Twin (-2021)</b>			
AND-S 31 / 38 L	403-6831	403-6881	100 cm
AND-Black 31 / 38 L	403-6832	403-6882	100 cm
AND-S 38 / 45 L	403-6836	403-6886	108 cm
AND-Black 38 / 45 L	403-6837	403-6887	108 cm
<b>Honda CRF 1100 L Africa Twin (2022-) / ADV Sports</b>			
AND-S 31 / 38 L	403-7831	403-7881	101 cm
AND-Black 31 / 38 L	403-7832	403-7882	101 cm
AND-S 38 / 45 L	403-7836	403-7886	109 cm
AND-Black 38 / 45 L	403-7837	403-7887	109 cm
<b>Honda CRF 1000 L Africa Twin (-2017)</b>			
AND-S 31 / 38 L	402-6831	402-6881	99 cm
AND-Black 31 / 38 L	402-6832	402-6882	99 cm
AND-S 38 / 45 L	402-6836	402-6886	107 cm
AND-Black 38 / 45 L	402-6837	402-6887	107 cm
<b>Honda CRF 1000 L Africa Twin (2018-) / ADV Sports</b>			
AND-S 31 / 38 L	402-7831	402-7881	99 cm
AND-Black 31 / 38 L	402-7832	402-7882	99 cm
AND-S 38 / 45 L	402-7836	402-7886	107 cm
AND-Black 38 / 45 L	402-7837	402-7887	107 cm



# ZEGA EVO

KTM 1290 Super ADV (2021-)	stainless steel rack	stainless steel rack (black)	width
AND-S 31 / 38 L	373-6831	373-6881	105 cm
AND-S 38 / 45 L	373-6836	373-6886	113 cm

KTM 1290 Super ADV (-2020) 1190, 1090, 1050 ADV / R			
AND-S 31 / 38 L	371-6831	371-6881	99 cm
AND-Black 31 / 38 L	371-6832	371-6882	99 cm
AND-S 38 / 45 L	371-6836	371-6886	107 cm
AND-Black 38 / 45 L	371-6837	371-6887	107 cm

KTM 890 / 790 ADV / R			
AND-S 31 / 38 L	372-6831	372-6881	99 cm
AND-Black 31 / 38 L	372-6832	372-6882	99 cm
AND-S 38 / 45 L	372-6836	372-6886	107 cm
AND-Black 38 / 45 L	372-6837	372-6887	107 cm

KTM 390 ADV			
AND-S 31 / 38 L	375-6831		94 cm
AND-Black 31 / 38 L	375-6832		94 cm

Triumph Tiger 900			
AND-S 31 / 38 L	421-6831	421-6881	98 cm
AND-Black 31 / 38 L	421-6832	421-6882	98 cm
AND-S 38 / 45 L	421-6836	421-6886	106 cm
AND-Black 38 / 45 L	421-6837	421-6887	106 cm

Yamaha Ténéré 700			
AND-S 31 / 38 L	632-6831	632-6881	96 cm
AND-Black 31 / 38 L	632-6832	632-6882	96 cm
AND-S 38 / 45 L	632-6836	632-6886	104 cm
AND-Black 38 / 45 L	632-6837	632-6887	104 cm

## ZEGA Evo X special systems

The ZEGA Evo, like all Touratech panniers before it, was not developed as an isolated product but was intended from the outset to be part of a luggage system. The outstanding practical benefits are the result of the unique combination of an elegant and indestructible pannier, an ingenious fastening mechanism and a terrain-immune rack made of 18 mm thick stainless steel tubes.

A typical feature of the special system is the recess on the right-hand pannier that allows it to nestle snugly against the exhaust. The panniers are positioned closer to the bike's centreline, the overall width is reduced, and the system as a whole appears more balanced thanks to the symmetrical pannier lids. Made from stainless steel, the sturdy pannier racks are scratch and rust resistant.

# ZEGA EVO X



### ZEGA Evo lock set for 2 cases

Scope of delivery:

- 1 x lock for case fastening left
- 1 x lock for case fastening right
- 4 x lock for case lock

050-6000

### BMW R 1250 GS / ADV / R 1200 GS (LC) / ADV (LC)

Special System with:	stainless steel rack	stainless steel rack black
ZEGA Evo AND-S 38/38 litres	045-6816	045-6866
ZEGA Evo AND-Black 38/38 litres	045-6817	045-6867
ZEGA Evo AND-S 45/45 litres	045-6826	045-6876
ZEGA Evo AND-Black 45/45 litres	045-6827	045-6877

### BMW F 850 GS / ADV / F 750 GS

Special System with:	stainless steel rack	stainless steel rack black
ZEGA Evo AND-S 38/38 litres	082-6816	082-6866
ZEGA Evo AND-Black 38/38 litres	082-6817	082-6867
ZEGA Evo AND-S 45/45 litres	082-6826	082-6876
ZEGA Evo AND-Black 45/45 litres	082-6827	082-6877

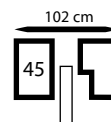
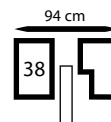
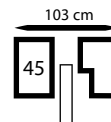
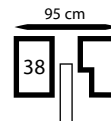

# ZEGA EVO X

## Harley-Davidson Pan America™ 1250

ZEGA Evo X "Premium Edition" special system "And-Black" 45/45 litres with stainless steel rack black for Harley-Davidson Pan America™ 1250 including two inner bags and six case locks.

440-0001



## Honda CRF 1100L Africa Twin (-2021)

Special System with:	stainless steel rack	stainless steel rack black
ZEGA Evo AND-S 38/38 litres	403-6016	403-6066
ZEGA Evo AND-Black 38/38 litres	403-6017	403-6067
ZEGA Evo AND-S 45/45 litres	403-6026	403-6076
ZEGA Evo AND-Black 45/45 litres	403-6027	403-6077

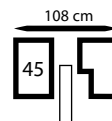
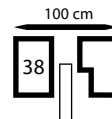

## Honda CRF 1100L Africa Twin (2022-) / Adventure Sports

Special System with:	stainless steel rack	stainless steel rack black
ZEGA Evo AND-S 38/38 litres	403-7016	403-7066
ZEGA Evo AND-Black 38/38 litres	403-7017	403-7067
ZEGA Evo AND-S 45/45 litres	403-7026	403-7076
ZEGA Evo AND-Black 45/45 litres	403-7027	403-7077

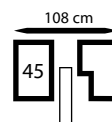
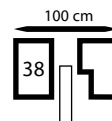

## Honda CRF 1000L Africa Twin (2018-) / Adventure Sports

Special System with:	stainless steel rack	stainless steel rack black
ZEGA Evo AND-S 38/38 litres	402-7016	402-7066
ZEGA Evo AND-Black 38/38 litres	402-7017	402-7067
ZEGA Evo AND-S 45/45 litres	402-7026	402-7076
ZEGA Evo AND-Black 45/45 litres	402-7027	402-7077

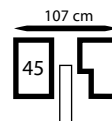
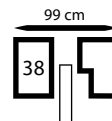

## KTM 1290 Super ADV (2021-)

Special System with:	stainless steel rack	stainless steel rack black
ZEGA Evo AND-S 38/38 litres	<b>373-6816</b>	<b>373-6866</b>
ZEGA Evo AND-Black 38/38 litres	<b>373-6817</b>	<b>373-6867</b>
ZEGA Evo AND-S 45/45 litres	<b>373-6826</b>	<b>373-6876</b>
ZEGA Evo AND-Black 45/45 litres	<b>373-6827</b>	<b>373-6877</b>

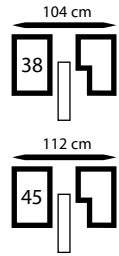

## KTM 1050 / 1090 / 1190 ADV/R / 1290 Super ADV (-2020)

Special System with:	stainless steel rack	stainless steel rack black
ZEGA Evo AND-S 38/38 litres	<b>371-6816</b>	<b>371-6866</b>
ZEGA Evo AND-Black 38/38 litres	<b>371-6817</b>	<b>371-6867</b>
ZEGA Evo AND-S 45/45 litres	<b>371-6826</b>	<b>371-6876</b>
ZEGA Evo AND-Black 45/45 litres	<b>371-6827</b>	<b>371-6877</b>

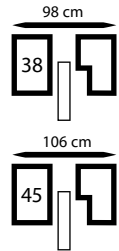

## KTM 790 / 890 ADV / R

Special System with:	stainless steel rack	stainless steel rack black
ZEGA Evo AND-S 38/38 litres	<b>372-6816</b>	<b>372-6866</b>
ZEGA Evo AND-Black 38/38 litres	<b>372-6817</b>	<b>372-6867</b>
ZEGA Evo AND-S 45/45 litres	<b>372-6826</b>	<b>372-6876</b>
ZEGA Evo AND-Black 45/45 litres	<b>372-6827</b>	<b>372-6877</b>

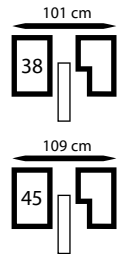

## Yamaha Ténéré 700

Special System with:	stainless steel rack	stainless steel rack black
ZEGA Evo AND-S 38/38 litres	<b>632-6816</b>	<b>632-6866</b>
ZEGA Evo AND-Black 38/38 litres	<b>632-6817</b>	<b>632-6867</b>
ZEGA Evo AND-S 45/45 litres	<b>632-6826</b>	<b>632-6876</b>
ZEGA Evo AND-Black 45/45 litres	<b>632-6827</b>	<b>632-6877</b>

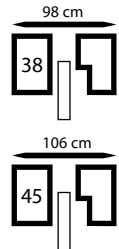

# MADE FOR ADVENTURE.



# SIMPLY ROBUST - TOURATECH PANNIER RACKS

## Reliable

- Robust stainless steel
- Pannier frame made from 18 mm diameter steel
- tube with a 2 mm thick wall
- Bolted crosspiece for better rigidity
- Black plastic coated.



## Mounting

- Easy to fit.
- Uses standard mounting points
- No modifications to rear footrests
- Mounting bolts are included
- Can be used with ZEGA panniers or other panniers in conjunction with our 18 mm mounting hardware



## BMW

	steel black	stainless steel	stainless steel black
F 700 / 800 GS / F 650 GS (Twin)	051-2230		
F 700 / 800 GS / F 650 GS (Twin)		048-5555	
F 750 GS / F 850 GS / ADV		082-5555	082-5560
R 850 / 11XX GS / ADV		051-0150	
R 1200 GS (-2012) R 1200 GS ADV (-2013)		051-0134	
R 1250 GS / ADV R 1200 GS (2013-) R 1200 GS ADV (2014-)		038-5555	038-5560

HONDA	steel black	stainless steel	stainless steel black
CRF 1100 L Africa Twin (-2021)		403-6555	403-6560
CRF 1100L Africa Twin (2022-) ADV Sports		403-5555	403-5560
CRF 1000 L Africa Twin (-2017)			402-5560
CRF 1000 L Africa Twin (2018-) / ADV Sports		402-6555	402-6556

KTM	steel black	stainless steel	stainless steel black
1290 S-ADV (2021-)		373-5555	373-5560
1290 S-ADV (-2020), 1190 / 1090 / 1050 / ADV / R /		371-5555	371-5560
790 / 890 ADV / R		372-5555	372-5560
690 Enduro / Enduro R (-2017)		051-0170	
390 ADV		375-5555	

TRIUMPH	steel black	stainless steel	stainless steel black
Tiger 900		421-5555	421-5560
Tiger 800		420-5557	420-5560

YAMAHA	steel black	stainless steel	stainless steel black
XT 1200 Z / ZE		046-5555	046-5561
Ténéré 700		632-5555	632-5560

## Pannier frame hoops

So far we have only designed heavy duty pannier frames for a few models. We have decided to sell the heavy duty frame hoops of as the most difficult thing when manufacturing heavy duty pannier racks is to bend the frame. The frame for DIY enthusiasts!

- 18 mm steel tubing (durable ST 52) / stainless steel
- 2 mm thick
- Ideal for use in conjunction with our 18 mm mounting kit (p. 480)
- Bent and welded
- Exterior dimensions: 350 mm x 245 mm
- Exacting tolerances

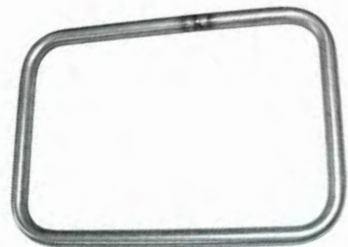

051-0300 steel

051-0302 stainless steel



# SIMPLY CLEVER - THE TOPCASE

In the cities of southern Europe it is virtually part of the scenery - the topcase. Whether scooter, travel enduro or sports machine, there is hardly a two-wheeler on the road without a box on its rear. Whereas the rather flat design required previously by law in Germany and giving the topcase the loving nickname „pizza case“, the southern Europeans have a far more pragmatic attitude to the topcase. Not really surprising, as motorcycles are an everyday means of transportation, in particular for urban dwellers. And there, the topcase as luggage compartment is unbeatable. Just open the lid and stuff everything inside that needs to be stowed. From a head of lettuce to business documents (pro-

bably best not to put both in together), you can stow just about anything securely and waterproof. Exactly: also securely. Because a good topcase can be locked. You can leave your helmet and gloves in the vehicle without having a bad conscience, your hands are free for shopping.

And when using a topcase, the vehicle remains nice and passable, just the ticket for a city runabout. And on big tours, this practical box is the perfect complement for the aluminum cases. Everything that is not too heavy and which needs to be accessible quickly can be stowed.





# SIMPLY TOPS - THE ZEGA TOPCASES

The ZEGA topcases by Touratech offer the same quality features as the well-established aluminum cases. They are made from 1.5 mm thick aluminum, are water and dustproof as well as being extremely robust. The corners are fitted with plastic reinforcements and the lid is equipped as standard with strap loops for securing additional luggage. Numerous practical ZEGA accessories, such as inner pockets, lid nets or bottle holders can be used to individualize the topcases. The locks can be matched to fit the aluminum cases and other components, such as a GPS mounting, for example, to avoid any confusion through numerous keys.

The ZEGA topcases are available with 25, 38 or 72 litres volume. You can even comfortably stow an integral helmet in the 38 volume variant. Natural aluminum, silver or black galvanized are available as surface treatment. Model-specific topcase carriers assure secure fixing to the motorcycle.



3 sizes

25 litres | 38 litres | 72  
litres



flexible,  
practical  
and compatible  
with accessories



3 colours

2 anodised versions





# ZEGA PRO

## TOPCASE

### WITH QUICK RELEASE SYSTEM

Attaches using the Rapid Trap quick release system and the Touratech Topcase brackets.



050-0682



Integral lock (1 piece)  
050-0870

Integral lock for Rapid Trap  
050-0871



## ZEGA Pro Topcase

The ZEGA Pro Topcase offers all of the same advantages as are found with our tried and tested ZEGA Pro panniers! Absolutely waterproof Topcase made from rugged, polished aluminium with protective corners!

On the lid are four top loops for attaching the luggage. The anodised version of the ZEGA Pro doesn't just shine in its fabulous natural aluminium look, but also prevents rubbing inside the case. The ultra thick, high quality anodised layer offers very special protection for the surface and helps to prevent discoloration.

### Dimensions:

**38 litres Topcase (l x w x h): 315 x 400 x 300 mm**  
(Helmet fits in!)



**ZEGA Pro  
Topcase**  
with Rapid Trap

**38 L**

38 litres

050-0680

050-0682 AND-S

050-0683 AND-Black



Locks for ZEGA Panniers

p. 484



### ZEGA Evo Topcase

with Rapid Trap

The ZEGA Evo Topcase offers all of the same advantages as are found with our ZEGA Evo panniers! Absolutely waterproof Topcase made from rugged, polished aluminium with ZEGA Evo protective corners!

On the lid are four top loops for attachment the luggage. The newly developed ventilation system relieves the pressure in or on the pannier if there's a change in altitude. The ultra thick, high quality anodised layer of the ZEGA Evo doesn't just shine in its fabulous look, but also prevents rubbing inside the case. The pannier is easy to transport thanks to the carrying handle.

25 litres Topcase, (L x W x H): 315 x 400 x 180 mm

050-6066 AND-S

050-6067 AND-Black

38 litres Topcase, (L x W x H): 315 x 400 x 300 mm  
(Helmet fits in!)

050-6076 AND-S

050-6077 AND-Black

38 L



25 L





## ZEGA Topcase XXL

We have developed the Topcase XXL to meet special space requirements. It offers enough space for 2 adventure helmets or your entire riding gear. Thanks to the fabulous volume of 72 litres, possible uses are almost limitless.

The special, stainless steel, base reinforcement provides adequate stability. With its two super-solid carrying handles, this waterproof box can be transported comfortably and fitted onto your topcase carrier with perfect ease. The Rapid Trap, tried and tested ten thousand times over, automatically snaps into place and holds the topcase securely on your bike.

In addition to our Alu-Natur version, the Topcase XXL is also available in our anodised versions And-S and And-Black in the ZEGA Evo pannier look. It goes without saying that you'll also find our proven plastic corners on this jumbo topcase as well. The Touratech obligatory attachment eyes on the lid and the typical ZEGA Evo (AND-S & AND-Black) hooks inside the lid allow you to upgrade your new Topcase XXL individually. Of course, the topcase can also be locked and it is waterproof. (Lock set not included.)

Volume: 72 Litres

Dimensions: 32 x 60 x 40 cm

050-6085

050-6086 AND-S

050-6087 AND-Black



72 L

We recommend to use the Topcase XXL only in conjunction with these specially reinforced Topcase carriers.

	stainless steel	stainless steel - black
BMW R 1250 GS / ADV BMW R 1200 GS (2013-) / ADV	045-5457	045-5458
BMW F 850 GS / ADV   F 750 GS	082-5670	
Harley-Davidson Pan America 1250		440-5456
Yamaha Ténéré 700	632-5455	632-5456



## Luggage plate for Touratech Topcase rack and BMW Adventure luggage racks

Do you need more stability for large soft luggage on your Touratech top case carrier or BMW Adventure luggage rack? This luggage plate increases the contact surface, is super stable and allows even large pieces of luggage to be securely fastened.

037-5450



## ZEGA Evo / ZEGA Pro Topcase rack

082-5457

The special carrier for our ZEGA Evo / ZEGA Pro Topcases.

Made entirely of stainless steel, the Topcase rack is the perfect way to attach ZEGA Evo / ZEGA Pro Topcases to your bike. The Topcase rack can be used on its own or in conjunction with our pannier system.



	stainless steel	stainless steel - black
BMW R 1250 GS ADV / R 1200 GS ADV	045-5457	
BMW R 1250 GS / R 1200 GS (2013-)	045-5455	
BMW R 1200 GS (-2012)	044-5455	
BMW F 850 GS / F 750 GS TP*	082-5457	
BMW F 850 GS ADV	082-5670	
BMW F 800 GS / ADV / F 700 GS	048-0183	
BMW F 650 GS (Twin)	048-0183	407-5455
Kawasaki Versys 1000		373-5455
KTM 1290 S-ADV (2021-)	373-5454	371-5456
KTM 1050 ADV / 1090 ADV / 1190 ADV / 1290 S-ADV (-2020)	371-5455	
KTM 790 / 890 ADV / R	372-5455	372-5456
KTM 390 ADV	375-5457	
Harley-Davidson Pan America 1250		440-5456
Honda CRF 1100 L Africa Twin (-2021)	403-5455	403-5456
Honda CRF 1100 L Africa Twin (2022-) / Adventure Sports	403-5457	
Honda CRF 1000 L Africa Twin	402-5455	402-5456
Honda CRF 1000 L Africa Twin Adventure Sports	402-6455	
Triumph Tiger Explorer	422-5455	
Triumph Tiger 900	421-5455	421-5456
Yamaha XT 1200Z	046-0610	
Yamaha Ténéré 700	632-5455	632-5456
Pannier frame hoop	051-0301	

\*TP – BMW Touring Paket



NEW IDEAS FOR MOTORBIKES

**TOURATECH**



Accessories ZEGA CASE

p. 484



Inner bags and pannier lid bags

p. 504







# ACCESSORIES

ZUBEHÖR

ACCESSOIRES

ACCESSORI

ACCESORIOS

Accessories BMW ADV CASE

p. 498



Straps

p. 512





# THE ZEGA UNIVERSE

The Touratech aluminum cases are far more than just being extremely robust luggage containers. They form the basis for an entire universe of specifically adapted accessories. With the need for only minimal space requirements, the tailor-made ZEGA accessories offer intelligent solutions for the numerous needs of motorcycle travel. Touratech offers a unique portfolio of accessories for the aluminum cases of the Mundo and ZEGA lines. To save having to drill unnecessary holes into the elegant case when using various holders for bottles, canisters or first aid kits, Touratech has developed a universal base plate into which the required holders can simply be click-mounted. Odor-intensive

substances such as petrol and oil can be transported as external loads using special canister mountings. The same applies to bottles with drinks or the first aid kit which can be attached to the outside of the case and are thus readily accessible. For the transportation of additional luggage, a broad selection of textile bags and nets is available which can be attached to lid or sides of the ZEGA. Warm clothing, rain gear or useful small items are therefore always in reach quickly. Options for the interior design of cases also leave nothing to be desired. From waterproof bags via special bags which allow optimal space utilization of the lid, to special solutions such as laptop or tool bags, everything has been taken into account. And once you have arrived at your destination, the ZEGA cases can fully demonstrate their versatility. Add a cushion and make a seat out of your case, the ZEGA table turns your aluminum case into a stylish table for an outdoor banquet.

A number of the detailed solutions serve to individualize the boxes: this includes a carrying handle, safety devices for the lids and locks, as well as screw-retained loops for customer-specific transportation needs.

Sticker sets, reflective strips and colored plastic corners make every ZEGA case distinctive. And, of course, the ZEGA Pro topcases benefit from many of the described solutions.





higher level  
of flexibility



more luggage  
compartment



more comfort



quick access



more protection





# ACCESSORIES ZEGA CASE

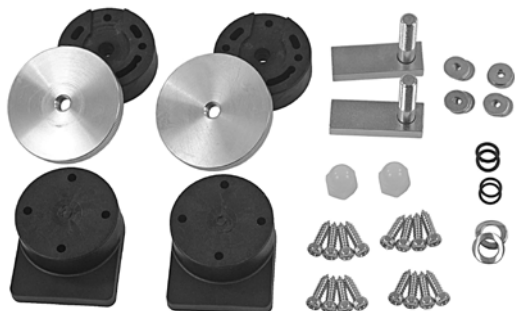

## Pannier Mounting Kit

Maybe you already have a pannier rack on your machine, or maybe there is no Touratech pannier rack for your motorcycle. With the help of this mounting kit, your new ZEGA Pro/Mundo aluminium case will fit on just about any pannier rack.

This mounting kit can be fitted individually to any aluminium case. In addition, you can determine the height and angle of your case yourself.

### Pannier mounting kit 18 mm

053-0020



## Locks for ZEGA Panniers

### ZEGA Pro / Pro2 / Mundo

These installation locks are only suitable for ZEGA Pro2 / ZEGA Pro / ZEGA Mundo and can be installed without drilling/filing.

If you require a certain key number, please enter it in step 7 of the order transaction.

### Integral lock (1 piece)

050-0870

### Integral locks set with 2 equivalent locks

050-0872

### Integral locks set with 4 equivalent locks

050-0874

### Integral lock for Rapid Trap

050-0871

### Integral locks set for release catches ZEGA Pro2

050-3300

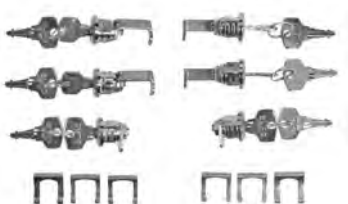

## ZEGA Evo lock set for 2 cases

These installation locks are especially suitable for ZEGA Evo and can be installed without drilling/filing. Set for both cases!

Scope of delivery:

- 1 x lock for case fastening left
- 1 x lock for case fastening right
- 4 x lock for case lock

050-6000



## ZEGA Evo lock set for Topcase

These installation locks are especially suitable for ZEGA Evo Topcases and can be installed without drilling/filing.

Scope of delivery:

- 1 x lock for case lock
- 1 x lock for Rapid Trap

050-6001

## ZEGA lock set for Topcase XXL

These installation locks are especially suitable for ZEGA Topcases XXL and can be installed without drilling/filing.

Scope of delivery:

- 2 x lock for case lock
- 1 x lock for Rapid Trap

050-6002



## Strap Bracket

Screw this strap bracket onto your panniers and fix canisters or other objects that could not be stowed away in the panniers. The rugged strap bracket comes with screws.

050-0200



## Touratech bottle opener for wall or case mounting

- made of stainless, durable steel
- designed specifically for all ZEGA cases and ZEGA top cases
- opens any crown cap bottle
- mounting materials included in scope of delivery
- can be mounted anywhere

050-0782



## Spare Part - Protective Strip ZEGA Pro

The highly robust protective strip along the carcass is screwed on and so is easily replaced when necessary – perhaps after a fall.

Set of 2 parts

050-0890 black

The same applies to the strong protective corners on the lid.

## Spare Part - Protective Corners ZEGA Pro

Set for 4 corners

050-0892 black





## Toolbox for original TOURATECH case carrier, exterior installation

You only need the large volume of your Touratech ZEGA cases on tour? And you don't want to carry around empty cases in every day use? The Touratech tool box is the ideal solution for the safe storage of small items on your GS. The optimal utilisation of space on the vehicle allows tools, first-aid kit, breakdown kit and many other useful items to remain on the motorcycle permanently and without interfering.

050-0903



## Internal bag for toolbox

### Organise your travel toolkit!

The internal bag was especially developed for our toolbox for the BMW R 1200 GS Adventure. It is robust with a high-quality finish, and includes loops to hold your tools. When folded out, the tool bag is the perfect mat for roadside repairs - you will never have to look for disassembled small parts in the dirt again!

Dimensions approx.: 7 x 30 x 10/14 cm

Also for universal use. Supplied without tools.

055-5611

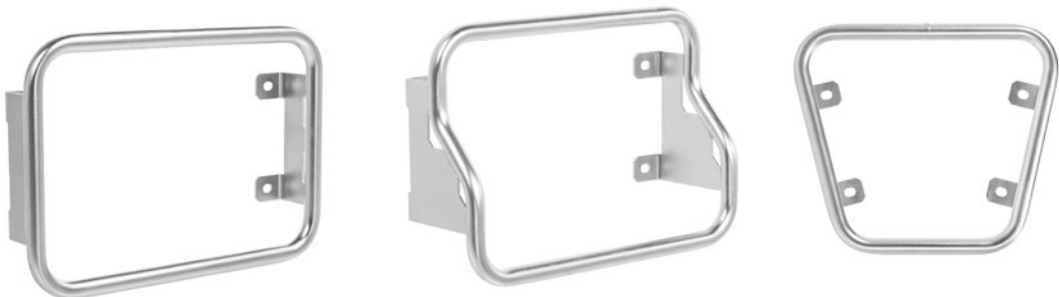

### Wall bracket for Touratech ZEGA panniers and topcases

They are space-saving and versatile, the Touratech wall holders for ZEGA cases. Simply mount your panniers on the wall behind your motorbike. The panniers are no longer in the way when they are not needed. This way they won't get unnecessary scratches or dents.

Due to the clever construction similar to a pannier rack, the panniers can be mounted on the holders even when fully loaded. This makes the Touratech wall brackets 100% usable on motorhomes, trailers or pickup trucks, in contrast to the usual simple bent sheet metal constructions.

051-0303 ZEGA Evo, Pro2, Pro, Mundo pannier

051-0304 ZEGA Evo X and Pro2 special system panier

051-0305 ZEGA Evo and Pro Topcase



## ZEGA-table

### ZEGA Evo / Pro / Pro 2 / Mundo

A brilliant addition to the pannier set.

The ZEGA-table turns your two panniers into a large table in just a few seconds. With this piece of equipment you can also entertain some more guests when travelling. Can be stored easily in your panniers.

050-0822



## ZEGA Pro World Map Pannier Label,

### Black-and-White

This label, printed on high quality, long-lasting film, adds the finishing touch to your pannier: it's a complete map of the world that is cut specifically to fit its size. All you have to do after sticking it on is decide where to go ...

050-0800 black



## Reflective Stripes for ZEGA Pro

### Pannier Edges (2 pieces)

Safety first. We offer these reflective stripes that have been cut specifically to fit the edges of the ZEGA Pro. The same material is used to highlight HGV trailers. Highly visible and appropriately strong.

050-0806 white

050-0807 orange

050-0887 red

050-0888 black





## Carrying grip EVO

### ZEGA Pro / ZEGA Mundo

Add value to your ZEGA Pro, Pro2 or ZEGA Mundo cases now and gain that extra comfort! Now the carrying grip of the ZEGA Evo is available as accessory. And best of all: it also fits the ZEGA Pro topcases, the ZEGA Pro, ZEGA Pro2 and the ZEGA Mundo cases.

The carrying grip is made of robust, weatherproof webbing and a comfortable plastic grip. Simply screw the carrying grip into the provided grip recess of the case lid. This ensures absolute wear comfort and the grip does not interfere when lashing down luggage nor when sitting on the case.

- Fits ZEGA Pro topcases, ZEGA Mundo, ZEGA Pro, ZEGA Pro2 and ZEGA Evo.
- Comfortable plastic grip
- Robust and weatherproof webbing
- Fits the grip recess precisely
- Is screwed tight to the case lid
- Mounting material, mounting instructions and 1 carrying grip included in scope of delivery

050-0869

## Carrying Handle and Lashing Strap

### ZEGA Pro / ZEGA Mundo / BMW Adventure Case

The multifunction solution for the ZEGA Pro pannier.

The carrying handle is perfect for carrying the pannier with ease. The handle can also be used to secure packsacks and similar items to the pannier lid. Which means the handle can be left on the pannier.

050-0882





## Pannier lid bag EVO

for ZEGA and BMW panniers

Based on the popular design of the ZEGA Evo cases, we have developed this hard-shell case lid bag that is shock-proof, waterproof and fits perfectly on your pannier.

The pannier lid bag offers an often crucial additional storage space and is very easy to mount on the lashing eyes of the pannier lids of all BMW cases as well as ZEGA Evo, Pro, Pro2 and Mundo.

The sewn-in yellow inner pocket guarantees protection from rainwater thanks to its roll closure and taped seams and allows you to find your contents quickly.

- Designed for ZEGA Evo cases, fits all ZEGA and BMW ADV cases
- Dimensionally stable hard case for optimum protection of contents
- Washable
- Built for durability
- Best fit
- Securely attached and yet quickly removable from the vehicle
- Waterproof, yellow inner pocket sewn in

Please note the maximum load of your pannier system!

Please use a paint protection film if necessary!

Dimensions: (L x W x H) approx. 38 x 23 x 11 cm

Volume: approx. 9 litres, colour: black

055-1483



## Protective pannier lid covering

for BMW aluminium panniers

The protective pannier covering is well able to meet the toughest demands - when you use the pannier as a motorcycle assembly stand, for example.

- High slip resistance
- High wear resistance
- Impact resistant
- Durable
- Precisely cut to size

050-3430 31 L

050-3431 38 L

050-3432 45 L





## Backrest cushion for ZEGA Evo / ZEGA Pro topcase

Extremely comfortable backrest cushion for ZEGA Evo / ZEGA Pro Topcases.

A special proprietary closed-pore foam provides enduring comfort. Your pillion passenger will be delighted!

Accurate recesses in the backrest cushion make it easy to fit on the back of the Topcase.

Also suitable for the original BMW aluminium topcase and Ducati Multistrada aluminium topcase.

050-0902



## Jerrycan

This jerrycan with a standard opening (suitable for pump nozzles) lets you safely transport the liquids you need – such as red wine, water (not taste-neutral) or even petrol. The jerrycan is approved for use as a fuel container. CAUTION! If used as a petrol can make sure it is fastened securely to an area of the motorbike that is less vulnerable to impacts. We recommend using our jerrycan bracket for our case systems

Colour: black

**capacity 3 litres (filling capacity)**

070-0573

**capacity 2 litres (filling capacity)**

070-0580



## Canister 2 litres

Polyethylene canister, Made in Germany with integral filler and spout. TÜV tested industrial quality.

Colour: black, Weight: 245 g

Dimensions: 145 x 80 x 275 mm

070-0520



## Water canister 2 litres

Food safe

Dimensions: 145 x 80 x 275 mm

Color: transparent

070-2220



# ZEGA MUNDO ZEGA PRO

## ADAPTER PLATES & ACCESSORIES

### Adapter Plate Bottle Holder

- suitable i.e. for our water bottles 070-0530
- including lashing straps

050-0910	single without bottle
050-0911	double without bottles
050-3218	single with bottle
050-3219	double with bottles





### Adapter Plate Spare Canister (including Lashing Straps)

- for our spare canisters
- including lashing straps / without canister

050-0913 for 3 l canister

050-0912 for 2 l canister



### ZEGA Pro / ZEGA Mundo canister holder with canister

050-3214 3 l

050-3215 2 l

050-3221 2 l oil canister



### Adapter plate with Touratech Waterproof additional bag

- including Touratech Waterproof additional bag

050-0840 size S 2 l

050-0842 size L 3,5 l



## Luggage space expansion

### ZEGA & BMW Adventure Case

We have designed a series with a sensible luggage space expansion for your new ZEGA PRO. This adapter solution can be fitted anywhere on the outside of the case. At the heart of the system is the base plate. This „docking station“ is appropriate and necessary for all of the adapters offered on this page. The system offers the advantage of enabling any adapter to be used on a single base plate. So once the base plate has been fitted, you can use any of the adapter plates shown here to suit your particular purpose - it's a flexible, well-designed system that is ideal for all kinds of trips'n'tours. The base plate and adapter are extremely sturdy, and mean that additional fuel cans, bottles etc. can be safely and securely attached without damaging or dirtying your other luggage.

Made of stainless steel with all the necessary attachments and detailed fitting instructions.



050-0830

### Base plate

050-0830

Simple and fast - changed by just one click!

### Adapter plate with Touratech EXTREME Edition Waterproof additional bag

- including Touratech EXTREME Edition Waterproof additional bag

050-3424

3 l





# ZEGA PRO 2 ADAPTER PLATES & ACCESSORIES



## Bottle Holder

- suitable i.e. for our water bottles 070-0008
- including lashing straps

050-3201 without bottles

050-3217 with bottles



## Adapter Plate Spare Canister 2 I

- for our spare canister 070-0520 (Oil)/ 070-0580 (Petrol)
- including lashing straps / without canister

050-3202

ZEGA Pro2 canister holder with canister 2 litres

050-3212

ZEGA Pro2 canister holder with oil canister 2 litres

050-3220



## Adapter Plate Spare Canister 3 I

- for our spare canister 070-0573
- including lashing straps / without canister

050-3203

ZEGA Pro2 canister holder with canister 3 litres

050-3213



## Adapter Plate - accessory holder with Touratech Waterproof additional bags

050-3207 size S

050-3208 size L



# ZEGA EVO

## ADAPTER PLATES & ACCESSORIES

### ZEGA Evo bottle holder

- suitable i.e. for our water bottles 070-0008
- including lashing straps

050-3401 without bottles

050-3417 including bottles



### ZEGA Evo adapter Plate Spare Canister 2 l

- for our spare canister 070-0520 (Oil)/ 070-0580 (Petrol)
- including lashing straps / without canister

050-3402

Canister holder with canister 2 litres

050-3412

Canister holder with oil canister 2 litres

050-3420



### ZEGA Evo adapter plate spare canister 3 l

- for our spare canister 070-0573
- including lashing straps / without canister

050-3403

Canister holder with canister 3 litres

050-3413



### ZEGA Evo adapter plate - accessory holder with Touratech Waterproof additional bags

050-3407 size S 2 l

050-3408 size L 3,5 l



### Adapter plate with Touratech EXTREME Edition Waterproof additional bag

- including Touratech EXTREME Edition Waterproof additional bag

050-3423 3 l



# ACCESSORIES

## BMW ADVENTURE CASE



### Adapter Plate – Universal

with support angle

050-0916



### Base plate

050-0830



### Adapter plate with Touratech EXTREME Edition Waterproof additional bag

Including Touratech EXTREME Edition Waterproof additional bag

050-3424

3 l



Simple And fast - changed by just one click!

### Adapter plate with Touratech Waterproof additional bag

Including Touratech Waterproof additional bags

050-0840 size S

2 l

050-0842 size L

3,5 l

## Adapter Plate Bottle Holder

- suitable i.e. for our water bottles 070-0008
- including lashing straps

050-0910 single without bottle

050-0911 double without bottles

050-3218 single with bottle

050-3219 double with bottles



## Adapter Plate Spare Canister (including Lashing Straps)

- for our spare canister 070-0520 (Oil) / 070-0580 (Petrol)
- including lashing straps / without canister

050-0912



## Adapter plate spare canister (including lashing straps)

- for our 3L spare canister 070-0573
- including lashing straps / without canister

050-0913



## Protective pannier lid covering

### for BMW aluminium panniers

The protective pannier covering is well able to meet the toughest demands - when you use the pannier as a motorcycle assembly stand, for example.

- High slip resistance
- High wear resistance
- Impact resistant
- Durable
- Precisely cut to size

045-5599

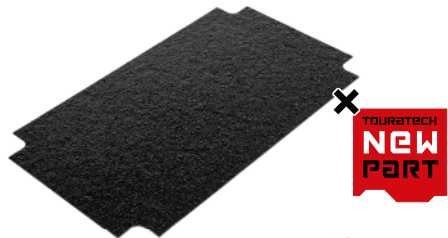

TOURATECH  
**NEW PART**





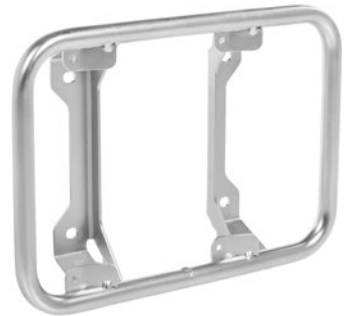
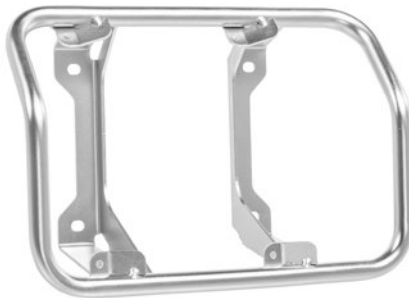

### Wall bracket for original BMW Adventure aluminium panniers and topcases

They are space-saving and versatile, the Touratech wall holders for original BMW Adventure aluminium panniers. Simply mount your panniers on the wall behind your motorbike. The panniers are no longer in the way when they are not needed. This way they won't get unnecessary scratches or dents.

Due to the clever construction similar to a pannier rack, the panniers can be mounted on the holders even when fully loaded. This makes the Touratech wall brackets 100% usable on motorhomes, trailers or pickup trucks, in contrast to the usual simple bent sheet metal constructions.

**045-6150** original BMW Adventure aluminium panniers, set of 2

**045-6170** original BMW Adventure topcase



## Pannier extension VOLUME BOOSTER for original BMW aluminium pannier

Get the most out of your pannier and create maximum space! The VOLUME BOOSTER pannier extension increases the volume of your original BMW aluminium pannier by 12 litres!

Simply place the VOLUME BOOSTER between the pannier and the lid to increase the height of your pannier by 11 cm. The ingenious mechanism engages in the lockable latch of your pannier and makes any other locking system superfluous. In a matter of seconds, you can hook in the new safety cable and open, load and close your pannier as usual. The pannier extension is made of the same high-quality materials as your BMW pannier. Thanks to the precise fit and the seal in the plastic frame, your pannier remains waterproof and fits perfectly.



The advantages at a glance:

- 12 litres additional luggage volume
- Securely lockable using existing latches – no additional latches required
- Easy to open and completely removable
- Made of the same high-quality, visually and technically identical materials as your BMW pannier
- Waterproof due to special seal in the plastic frame
- Robust construction made in Germany

Compatible with BMW aluminium pannier for:

- BMW R 1250 GS
- BMW R 1250 GS Adventure
- BMW R 1200 GS (LC)
- BMW R 1200 GS Adventure (LC)
- BMW F 850 GS Adventure

Original BMW OEM number:

pannier right: 8 562 410 (ECE) / 8 414 630 (USA)

pannier left: 8 562 409 (ECE) / 8 414 629 (USA)

Size: (L x W x H) approx. 27 x 44 x 11 cm

Volume: approx. 12 litres

We recommend using only one VOLUME BOOSTER per pannier! Please observe the permissible maximum payload of your vehicle! The BMW pannier is not included!

050-1010	aluminium
050-1011	aluminium (set of 2)
050-1012	black
050-1013	black (set of 2)





### Touratech Booster Bag

The Touratech pannier bag especially for your new VOLUME BOOSTER!

The Booster bags also fit in our ZEGA aluminium panniers perfectly. Discover the combination possibilities!

With these versatile bags used for arranging your luggage and keeping it together you will be better organised immediately. The material is super robust and water repellent! It has a full length zip and a carrying handle of course.

Size: 42 x 25 x 9 cm

050-0837



### Top case lid inner pocket for ZEGA Evo / ZEGA Pro

Ideal for an orderly case and perfect for quick access to important travel utensils! The inner pocket for the topcase lid, made of extremely robust Cordura 1100, is easy to add, secure and simple to attach and packed quickly via the circumferential robust zip. The robust case grip allows comfortable transport of the case when fully packed! Sewn-in reinforcements assure optimal dimensional stability and the lid inner pockets ideally complement the inner pockets of the cases. The case is attached via two provided adjustable straps with click closures and four laser-cut stainless steel mounting brackets. Of course the required longer screws and self-locking nuts are included in our delivery and mounting is child's play.

Dimensions: approx. 37 x 30 x 7 cm

Volume: approx. 8 liters

Capacity up to 3kg

050-0793 ZEGA Evo

050-0797 ZEGA Pro



## Luggage Net for Pannier Lids

ZEGA Evo / Pro / Pro2 /  
BMW Adventure Case & Topcase

We create additional space and order with the luggage net for the inside of pannier lids. This makes it easy, for instance, to secure a rain jacket or laundry bag to the inside of the pannier. Or you can use the net to attach one of our small bags or hotchpotches to the lid. And you'll always have any important items instantly to hand when you open it.

050-0812 ZEGA Pro / ZEGA Pro2

050-0821 BMW Adv Case /Topcase

050-0839 ZEGA Evo



## ZEGA Evo / ZEGA Pro Case Lid Inner Bag

The case lid inner bags let you make optimum use of the storage space in the lid of the ZEGA Evo / Pro. Reinforced with 7 mm foam on the lower and upper sides, the bag is secured directly in the lid of the ZEGA case using two straps. Heavy items (e.g. a tool roll) can be securely attached anywhere inside the bag using optional straps. The carrying handle lets you take the resilient, dirt-resistant Cordura bag with you everywhere you go. This inner bag is the fastest and easiest way to make sure that all those small items you need time and again are always close to hand. Made from Teflon-coated Cordura. Can carry up to 3 kg.



### Case lid inner bag 31, for 31 litre cases.

Dimensions: approx. 42 x 18 x 8 cm. Capacity: approx. 6 litres

050-0784 ZEGA Evo

050-0794 ZEGA Pro

### Case lid inner bag 38, for 38 litre cases.

Dimensions: approx. 42 x 22 x 8 cm. Capacity: approx. 7 litres.

050-0785 ZEGA Evo

050-0795 ZEGA Pro

### Case lid inner bag 45, for 45 litre cases.

Dimensions: approx. 42 x 26 x 8 cm. Capacity: approx. 8 litres.

050-0786 ZEGA Evo

050-0796 ZEGA Pro





## ZEGA TopCase Bag 38

There is also a tailor-made ZEGA-bag available for our top box. Two carrying handles and a wraparound zip make handling easy.

050-0849



## Inner bag with valve for panniers

ZEGA Pro / ZEGA Pro2 / ZEGA Mundo / ZEGA Evo  
by Touratech Waterproof

Specially designed inner bags for all Touratech case systems, manufactured by Touratech Waterproof to their well-known high quality standards. The valve fitted to the top enables squeezing out even the last remaining air when rolling the bag together; this allows the bag to fit every case, topcase, rucksack, leather bag, etc. without losing valuable storage space. The proven Touratech Waterproof roll zipper and the robust, 100% waterproof material also enable the bag to be fitted universally to the case, the luggage carrier or the passenger seat.

050-0851



## Internal bag for toolbox

Organise your travel toolkit!

The internal bag was especially developed for our toolbox for the BMW R1200GS Adventure. It is robust with a high-quality finish, and includes loops to hold your tools. When folded out, the tool bag is the perfect mat for roadside repairs - you will never have to look for disassembled small parts in the dirt again!

Dimensions: approx. 7 x 30 x 10/14 cm

Also for universal use. Supplied without tools.

055-5611

## ZEGA Bag for ZEGA Evo / Pro / Pro2 / Mundo

Keep everything close to hand, easy to get out and pack away again, keep your tent or hotel room organised, and no aluminium rubbing on your clothing - this is the super robust ZEGA Bag. This sports and travel bag has been specially developed for our ZEGA Evo cases. If the ZEGA Bag is not full, it can be folded down to save space. It has two practical carry handles. It has a continuous zipper around the sides for easy loading outside the case and a double zip on the top for easy access to your luggage when the ZEGA Bag is in the case. Made from super robust, water-repellent and dirt-resistant nylon.

### ZEGA Bag 31, inner bag for 31 litre cases.

Dimensions: approx. 18 x 42 x 34 cm, Capacity: approx. 28,5 litres  
050-0845

### ZEGA Bag 38, inner bag for 38 litre cases.

Dimensions: approx. 22 x 42 x 34 cm. Capacity: approx. 35 litres  
050-0846

### ZEGA Bag 45, inner bag for 45 litre cases.

Dimensions: approx. 26 x 42 x 34 cm. Capacity: approx. 41.5 litres  
050-0847

### Inner bag for „big“ BMW Vario pannier & Vario Topcase

045-5840

### Inner bag for „small“ BMW Vario pannier

045-5841



## Pannier carrier bag

Whether ZEGA Evo, Pro, Pro2, Mundo or BMW Adventure Case, this pannier bag puts them all away! Even the BMW Vario cases and every motorbike case currently available on the market fit inside.

Our vehicle logistics department has been swearing by these bags for years when loading our motorbikes!

- No dusting of the cases in the winter quarters
- No scratching of the cases and van bodywork during loading
- Super robust
- Big enough for panniers incl. accessory holders
- Any currently available motorbike case fits inside
- Universal use also for boots, helmets, etc.

Size: approx. 52 x 38 x 39 cm

055-1050





TOURATECH

TECH

TOURATECH

TOURATECH

D M TP 914

ACT

TOURATECH

TOURATECH

TOURATECH

## Touratech CUBE

Keep yourself organised... How often did our parents tell us this when we were children and we ignored them? When travelling we eventually understood what they wanted to tell us: if you only have one sock of the pair, if it starts snowing and there is only one warm glove left, if it is pouring with rain and you have to take everything out of your panniers just because the left sandal's missing, then you will know that your mother was usually right! Our Cubes help you solve this problem. With these versatile bags used for arranging your luggage and keeping it together you will be better organised immediately. The meshed top provides ventilation and you will see what is in the bag. It has a full length zip and a carrying handle of course. Both the Cubes and the Shoe Sac fit in our Zega aluminium panniers perfectly.



CUBE



HALF CUBE



### HALF CUBE

Dimension:  
approx. 25 x 18 x 8 cm  
Volume: approx. 5 litres

050-0834

### CUBE

Dimension:  
approx. 36 x 25 x 8 cm  
Volume: approx. 10,5 litres

050-0835

### BOOSTER CUBE

Dimension:  
approx. 42 x 25 x 9 cm  
Volume: approx. 9 litres

050-0836



BOOSTER CUBE



## Tool bag

**The ideal bag for all aluminium cases and luggage racks!**

If you want to stow your tools safely, require additional and extendable storage space on the pannier lids, are looking for a bag for different bikes or luggage racks and prefer absolute robustness and durability, then you are more than well served with this bag!

With different mounting straps it is possible to fit the bag in a number of ways using the supplied straps. Inner sewn loops effectively prevent slipping of the tool roll or other heavy objects.

A circumferential zip can quickly double the volume if required and small objects can be stowed in the outer pocket. A solid grip facilitates handling of the bag.



Size: approx. 35 x 18 x 15/25 cm,  
Volume: approx. 6/12 litres

**050-0832**



## Pannier lid bag "Folder"

**for ZEGA And BMW panniers**

**The ideal bag for all aluminium cases and luggage racks!**

Size: (L x W x H) approx. 40 x 22 x 15 cm,  
Volume: approx. 13 litres

**055-1482**

## Hooks for pannier lid, set of four, for 20 mm belt

Suitable for all ZEGA And BMW Adventure panniers

050-0885



## Additional pannier top bags

for original BMW plastic panniers (1 pair) for the BMW R 1200 GS

If ever you find your BMW Vario cases are too small we have a speedy solution in the shape of these rugged, easy-to-fit additional pannier top bags. Manufactured using high-strength Cordura fabric, they are tailor-made for the water-cooled GS and provide up to 30 litres of extra storage space, without getting in the way of the rider or passenger. To quickly increase their carrying capacity - e.g. during a trip - simply undo two zips. Only the outer sides of the bags expand, so the pillion passenger still has enough room. Reinforcements incorporated into the side walls make sure the bags keep their shape, and large reflective strips provide added safety.

Please note: Use paint protection film if necessary! (Item number 01-101-0100-0)

Size: (L x W x H) approx. 46 x 24 x 13/23 cm; Volume: approx. 2 x 10/2 x 15 litres

Colour: black

044-5810 up to 2012

045-5810 from 2013



### Variable Strap (2 pieces)

The strap with ratchet in the familiar, high-quality Touratech design. The strap has a brilliant velcro end so that it can be neatly rolled up and stowed.

055-1608 (1,50 meter)

### Strap with ratchet yellow, industrial use

The strap with ratchet in high-quality design. To secure the motor bike firmly on the trailer or in the bus. No hooks on ends, strap threads through motorcycle and back to ratchet.

Material: PES (polyester)

Length: 4 m, Width: 25 mm

055-0037



### ARNO STRAPS

The versatile little helpers for packing and lashing down. 18 mm wide straps with steel ARNO buckles have a load rating of 100kg. For those who don't trust plastic buckles.

Width: 18 mm

055-0031 length 750 mm

055-0032 length 1000 mm





## Strap It™ Motorbike Adjustable

"Perfect if you carry many varied shapes and sizes of luggage" Do you need to secure a range of different luggage items to your road bike, cruiser bike, dirt bike or ATV (Quad)? Want a strap that minimizes the risk of damage to you, your goods and your paint work? Then our Strap It™ Motorbike Adjustable is the perfect strap for your needs.

**Product description:** Combines a long length of webbing with a short length of our unique flat shock cord. An adjuster buckle joins both portions together and allows easy adjustment of strap length. Each extremity of the strap is fitted with a webbing loop that allows each portion to be wrapped around anchoring points in a permanent fashion, or simply looped over an anchoring point. Superior design qualities ensure the highest levels of safety, strength, ease of use and long life.

**Benefits:** Adjustable and very versatile. Adjusts easily to fit around most luggage items. Simply slip or wrap the strap around your luggage, fix down ends and you're off! Quality materials and good mechanical connections ensure these are the strongest of elasticised strap you will use on your bike. Safely holds 90 lb (45kg) in a straight pull, or 180 lb (90kg) when looped over cargo. Adjuster allows you to pull down tight for the strongest possible luggage hold. Available length: approx. 60" (45-150 cm), adjustable, 2 pieces; Available width: approx. 1" (2,5 cm)

055-0411	black
055-0413	black-orange
055-0406	black-blue



## And for light luggage: Strap It™ Pack Adjustable

Length: approx. 42" (106 cm), adjustable

Available Width: approx. 1" (1,6 cm) (2 pieces)

055-0421	black
055-0422	black-orange
055-0412	yellow



# TOPSELLER





Tank Bags

p. 516



Pillion Seat Bags

p. 534



# SOFT LUGGAGE

SOFTGEPÄCK

BAGAGES SOUPLES

BORSE SOFT

EQUIPAJE BLANDO



Tail Rack Bag

p. 536



Additional Bags

p. 539



p. 546





## WHY SOFT LUGGAGE?

- + QUICK ACCESS
- + FLEXIBLE ALTERNATIVE
- + OPTIMIZED CENTER OF GRAVITY
- + STORAGE SPACE CAN BE EXPANDED IF NECESSARY (I.E. ALL-ROUND ZIPPER, EXTERNAL BAG, EXTENSION)
- + LESS OVERALL WIDTH (THAN CASE SYSTEM)
- + LESS OVERALL HEIGHT (THAN TOP CASE)
- + DOES NOT IMPAIR LOOK OF VEHICLE
- + CAN BE USED TO SUPPLEMENT THE CASE SYSTEM

## WHY TOURATECH SOFT LUGGAGE?

- Vehicle-specific, precisely fitting base plate for secure, play-free attachment to the bike.
- The material that we use is certified Cordura fabric, as also used for protective motorcycle clothing and expedition equipment.
- Made for extreme loads and built to last - does not collapse like plastic cases, or dent like aluminum cases, yields as necessary.
- Securely attached but can be quickly taken off the bike.
- No troublesome improvisation with poorly fitting "universal" attachment kits - these luggage systems are developed specifically for each motorbike and we test the mountings as well as the durability of each product.



# WHY TOURATECH TANK BAGS?

Quality begins with the material. The Touratech tank bags are made of Teflon-coated Cordura, making them waterproof and resistant to dirt. The Cordura used for the bags is manufactured in a special process from polyamide (hence its high resistance to abrasion), coated with Teflon from DuPont, and is tested for harmful substances in line with the Oeko-Tex Standard 100. The Teflon coating prevents the material from fading. The tank bags are fitted in part with waterproof zips. Optionally available inside pockets with a reliable roll-up closure, ensure that the bags are 100% watertight. Matching rain covers are also available for ideal protection.

The reinforced side walls on the inside and a riveted plastic base insert prevent the bags from buckling and guarantee form stability even when they are only partly packed. The Adventure models feature a double hook fastening for maximum stability,

even under the toughest conditions, paired with lightning-fast removal. The Velcro drawstrings for fastening at the back allow the bag to be fitted tightly. The front and rear mounting pads can always remain affixed to the motorbike. Some of the tank bags have a foam base plate which matches the contour of the motorbike, while others have a flexible underside that moulds itself to fit various tanks.

Tank bags from Touratech cover every expectation regarding space and features to accommodate the rider's preferences, budget and needs, from the „AMBATO Pure“ for day-long rides and the fully-featured „AMBATO Exp“, through to the Touring, a perfect companion for weekend trips without a suitcase or for long shopping tours.







# AMBATO

## SOFT LUGGAGE SYSTEM



- |   |                                                                     |    |                                    |
|---|---------------------------------------------------------------------|----|------------------------------------|
| 1 | vehicle-specific base plate                                         | 10 | loops for pens                     |
| 2 | colored, waterproof tarpaulin                                       | 11 | quick-release plastic buckles      |
| 3 | 1100 Dtex Cordura fabric                                            | 12 | strong Velcro fastener             |
| 4 | fluorocarbon impregnation, Teflon coating                           | 13 | map pocket with large opening      |
| 5 | reflective 3M Scotchlite panels for maximum visibility              | 14 | water-resistant, high-quality zips |
| 6 | strong carry handle for practical transportation away from the bike | 15 | elastic straps for gloves          |
| 7 | all-round zip                                                       | 16 | side pockets with expansion flap   |
| 8 | inner pocket with Velcro closure                                    | 17 | large main compartment             |
| 9 | pocket for credit cards                                             | 18 | cable grommet                      |



# AMBATO PURE

THE HANDY ONES



This minimalist tank bag is a practical, well thought out piece of equipment that represents outstanding value for money. Flatter in shape and with fewer adornments, this model is suitable for all kinds of uses. For instance, it provides enough space for a day trip, can hold documents, a mobile phone, wallet and drinks on the way to a city sightseeing tour, and is also the preferred choice for off-road riding as it doesn't restrict the rider's movements while standing or affect the bike's handling. An ideal accessory providing excellent utility value at a great price.





## AMBATO PURE

	<b>BMW R 1250 GS / ADV / R 1200 GS (2013-) / ADV (2014-)</b>	<b>045-5802</b>
	Size: approx. 35 x 27 x 20 cm   Volume: approx. 9 litres	
	<b>BMW F 850 GS / F 850 GS ADV / F 750 GS</b>	<b>045-5802</b>
	Size: approx. 35 x 27 x 20 cm   Volume: approx. 9 litres	
	<b>Honda CRF 1100 L / CRF 1000 L Africa Twin</b>	<b>402-5802</b>
	Size: approx. 35 x 27 x 20 cm   Volume: approx. 9 litres	
	<b>Honda CRF 1100 L / CRF 1000 L Adventure Sports</b>	<b>402-5812</b>
	Size: approx. 35 x 27 x 20 cm   Volume: approx. 9 litres	
	<b>KTM 890 ADV / 890 ADV R / 790 ADV / 790 ADV R</b>	<b>372-5802</b>
	Size: approx. 30 x 15 x 19 cm   Volume: approx. 7 litres	
	<b>KTM 390 Adventure</b>	<b>372-5802</b>
	Size: approx. 30 x 15 x 19 cm   Volume: approx. 7 litres	
	<b>Yamaha Tenere 700</b>	<b>632-5802</b>
	Size: approx. 30 x 15 x 19 cm   Volume: approx. 7 litres	



## TOURING

## THE FLEXIBLE ONE

A timeless, classic design with proven features: That's what you get from our „Touring“ tank bag. With its large main compartment, two zippered outer pockets and a removable map pocket (DIN A4 size), this bag has exactly what you need for both small and large tours.

If you should unexpectedly need more storage space, the volume of the bag can be readily increased by opening its central surrounding zipper. The included carrying straps allow it to be also quickly and easily used as a shoulder bag or backpack. Practical, high-quality and extremely durable!

## TOURING

BMW R 1250 GS / ADV / R 1200 GS (LC) / R 1200 GS (LC) Adventure / F 850 GS / ADV / F 750 GS

045-5801

Size: approx. 35 x 26 x 18/25 cm | Volume: approx. 14/22 litres





# AMBATO EXP

## THE VERSATILE ONES



### It fits like a made-to-measure suit!

As we develop and offer the exclusive base plates and strong attachment kits for our robust tank bags for each specific vehicle, it is a given that a perfect fit with no play at all should be achieved!





The „AMBATO Exp“ is also notable for the expansion option with an all-round zipper; small items can easily be stored under the adjustable elastic

strap on the back. Thanks to the water-repellent cable hole, it's now easy to charge a mobile phone in the tank bag - plus the side pockets have an expansion pleat, which means there's even more room inside them than you would think. You'll be extremely impressed by the long list of special features.





## AMBATO EXP

	<b>BMW R 1250 GS / ADV / R 1200 GS (2013–) / ADV (2014–)</b> Size: approx. 37 x 27 x 22/32 cm   Volume: approx. 13/20 litres	<b>045-5800</b>
	<b>BMW F 850 GS / F 850 GS ADV / F 750 GS</b> Size: approx. 37 x 27 x 22/32 cm   Volume: approx. 13/20 litres	<b>045-5800</b>
	<b>Honda CRF 1100 L / CRF 1000 L Africa Twin</b> Size: approx. 37 x 27 x 22/32 cm   Volume: approx. 13/20 litres	<b>402-5800</b>
	<b>Honda CRF 1100 L / CRF 1000 L Adventure Sports</b> Size: approx. 37 x 27 x 22/32 cm   Volume: approx. 13/20 litres	<b>402-5810</b>
	<b>KTM 890 ADV / 890 ADV R / 790 ADV / 790 ADV R</b> Size: approx. 30 x 15 x 19/26 cm   Volume: approx. 7/10 litres	<b>372-5800</b>
	<b>KTM 390 Adventure</b> Size: approx. 30 x 15 x 19/26 cm   Volume: approx. 7/10 litres	<b>372-5800</b>
	<b>Yamaha Tenere 700</b> Size: approx. 30 x 15 x 19/26 cm   Volume: approx. 7/10 litres	<b>632-5800</b>

### AMBATO EXP Limited Yellow

BMW R 1250 GS / ADV / R 1200 GS (2013–) / ADV (2014–)  
F 850 GS / F 850 GS ADV / F 750 GS

Size: approx. 37 x 27 x 22/32 cm | Volume: approx. 13/20 litres

045-5829



### AMBATO EXP Limited Red

BMW R 1250 GS / ADV / R 1200 GS (2013–) / ADV (2014–)  
F 850 GS / F 850 GS ADV / F 750 GS

Size: approx. 37 x 27 x 22/32 cm | Volume: approx. 13/20 litres

045-5824

Honda CRF 1100 L / CRF 1000 L Africa Twin / ADV Sports

Size: approx. 37 x 27 x 22/32 cm | Volume: approx. 13/20 litres

402-5804 Africa Twin

402-5814 Adventure Sports



### AMBATO EXP Tricolor

Honda CRF 1100 L / CRF 1000 L Africa Twin / ADV Sports

Size: approx. 37 x 27 x 22/32 cm | Volume: approx. 13/20 litres

402-5803 Africa Twin

402-5813 Adventure Sports





**AMBATO EXP HP**

BMW R 1250 GS / ADV / R 1200 GS (2013-) / ADV (2014-)  
F 850 GS / F 850 GS ADV / F 750 GS

Size: approx. 37 x 27 x 22/32 cm | Volume: approx. 13/20 litres

045-5803

**AMBATO EXP Rallye**

BMW R 1250 GS / ADV / R 1200 GS (2013-) / ADV (2014-)  
F 850 GS / F 850 GS ADV / F 750 GS

Size: approx. 37 x 27 x 22/32 cm | Volume: approx. 13/20 litres

045-5828

**AMBATO EXP Sport**

BMW R 1250 GS / ADV / R 1200 GS (2013-) / ADV (2014-)  
F 850 GS / F 850 GS ADV / F 750 GS

Size: approx. 37 x 27 x 22/32 cm | Volume: approx. 13/20 litres

045-5825



372-5825

**AMBATO EXP Rallye**

KTM 1050 ADV / 1090 ADV / 1190 ADV/R / 1290 SADV

Size: approx. 37 x 27 x 22/32 cm | Volume: approx. 13/18 litres

371-5825

KTM 890 ADV / 890 ADV R / 790 ADV / 790 ADV R / 390 ADV

Size: approx. 30 x 15 x 19/26 cm | Volume: approx. 7/10 litres

372-5825





### Black Edition

BMW F 800 GS / ADV / F 700 GS / F 650 GS (Twin)

Size: approx. 30 x 33 x 18/26 cm

Volume: approx. 12/20 litres

048-5803

### Paint protection foil 3M universal

300 x 200 mm, transparent

Thickness of foil: 0.1 mm

101-0100



### Carrying strap Touratech

Whether for the tank bag, the rack pack or the helmet - the padded carrying strap Touratech is a real convenience in the transport of your luggage when the motorcycle is stationary.

- adjustable 80 cm to 140 cm
- width 4 cm
- padded

055-1621

### Rain cover for the tank bags

A very special rain cover!

Thanks to the rubber band, the rain cover can be lashed down in such a way as to substantially reduce the billowing out caused by the airflow. High-class finish with a large visible map compartment.

055-1269

Touratech Waterproof

055-3132 yellow

055-3133 black



## IBARRA



## Tank bag IBARRA

The „Ibarra“ tank bag has been specially designed for big trail bikes and large space requirements. With its foamed base plate, it sits precisely and securely on the tank. Thanks to a stable basic body made of high-quality textile fabric, the Ibarra retains its shape in all situations. The upper material is water-repellent and abrasion-resistant.

With its large main compartment, two zipped outer pockets and detachable map pocket in DIN A4 size, the Ibarra offers enough volume even on long tours. The expansion zip allows for additional storage space. The all-round zip provides easy access. Like all Touratech tank bags, the Ibarra can also be fitted or removed in seconds with click fasteners.

Elasticated straps with quick-release fasteners, YKK brand zips and reflective sections by 3M round off these high-quality features.

Dimensions: (L x W x H)

approx. 35 x 26 x 18/25 cm;

Volume: approx. 14/22 litres.

055-1281

The Ibarra tank bag is suitable for many different adventure bikes. Amongst others:

- BMW R 1250 GS, R 1250 GS Adventure
- BMW R 1200 GS (AC) / R 1200 GS (AC) Adventure
- BMW R 1200 GS (LC) / R 1200 GS (LC) Adventure
- BMW F 850 GS, F 850 GS Adventure, F 750 GS
- KTM 1290 Super Adventure R, 1290 Super Adventure S  
1090 Adventure / 1190 Adventure / 1050 Adventure



# IBARRA MINI

## Tank bag IBARRA Mini

Whether you are planning a day tour, or the tank of your machine will not allow for a larger tank rucksack, or if you simply have too little luggage, the Ibarra Mini fits every tank!

The tank rucksack offers an adequate 4 litres of luggage space and can be extended to 7 litres of volume via the circumferential zip. The map pocket offers sufficient room for the map section of the next stage, your smartphone or your 7" tablet. The document pocket always keeps your important documents at the ready and the velcro-attached pocket for credit cards guarantees fast clearance at the toll station.

The special anti-slip material on the underside and the individually adjustable straps secure the tank rucksack in place safely. The ingeniously simple strap lock and the clip locks allow uncomplicated refuelling.

Please note: Use paint protection film if necessary!

Size: (L x W x H) approx. 27 x 20 x 13/18 cm

Volume: approx. 4/7 litres

055-1287



## Tank bag IBARRA Midi

The Ibarra Midi tank bag fits perfectly on the compact tanks of the vast majority of touring enduros such as the Yamaha Tenere 700, KTM 890 Adventure, Honda Africa Twin or Triumph Tiger 900. The Midi even fits the BMW F 800 GS like a tailor-made suit. Excellent fit and unrestricted freedom of movement make the Ibarra Midi a loyal companion even on more demanding off-road stages.

An expandable main compartment, two zipped outer pockets and a removable map pocket offer sufficient volume on long tours. The cable grommet and credit card pocket in the lid are Touratech standard.

The tank bag is made of high-quality, certified Cordura. Elasticated drawstrings with quick-release fasteners, branded zips from YKK and reflective elements from 3M round off the high-quality features.

The special anti-slip material on the underside and the individually adjustable straps secure the tank rucksack in place safely. The ingeniously simple strap lock and the clip locks allow uncomplicated refuelling.

Please note: Use paint protection film if necessary!

Size: (L x W x H) approx. 30 x 15 x 19/26 cm

Volume: approx. 7/10 litres

055-1286

## IBARRA MIDI





## WHY PASSENGER BAGS?

- + TO INCREASE STORAGE SPACE
- + OPTIMIZED CENTER OF GRAVITY
- + ALTERNATIVE TO TANK RUCKSACK
- + GREATER MOBILITY
- + NO RESTRICTED VIEW OF COCKPIT
- + FOR A MORE SPORTY RIDE
- + VERSATILITY
- + OPTIMAL WEIGHT DISTRIBUTION WHEN USING BOTH TANK RUCKSACK AS WELL AS PASSENGER BAG
- + USE WITH RACK PACK OR REAR BAG IS POSSIBLE

## XTRA SMALL & XTRA FAST

- > for the complete weekend luggage
- > easy to remove
- > can be used as hand luggage
- > does not widen the silhouette

## AMBATO PURE



### Pillion seat bag „AMBATO Pure“

Size: (L x W x H) approx. 33 x 30 x 15 cm

Volume: approx. 14 litres

incl. attachment set

055-1283

## AMBATO EXP



### Pillion seat bag AMBATO Exp

Size: (L x W x H) approx. 33 x 30 x 20/32 cm

Volume: approx. 17/22 litres

incl. attachment set

055-1282

The pillion seat bags are suitable for many different adventure bikes. Amongst others:

- BMW R 1250 GS / ADV / R 1200 GS (2013–) / ADV (2014–)
- BMW R 1200 GS (–2012) / ADV (–2013)
- BMW F 850 GS / F 750 GS
- BMW F 800 GS / F 800 GS ADV / F 700 GS / F 650 GS (Twin)
- Honda VFR 1200 X Crosstourer
- Honda CRF 1100 L / CRF 1000 L Africa Twin / ADV Sports
- KTM 1050 Adventure / 1090 Adventure / 1290 Super Adventure / 1190 Adventure / R
- KTM 890 Adventure / 890 Adventure R / 790 Adventure / 790 Adventure R
- Triumph Tiger 900



## WHY TAIL BAGS?

- + ADDITIONAL STORAGE SPACE WHEN RIDING WITH PASSENGER
- + LIGHT AND STYLISH ALTERNATIVE TO TOP CASE
- + VEHICLE-SPECIFIC ADAPTATION
- + FAST ACCESS
- + SUFFICIENT SPACE FOR SMALL WEEKEND LUGGAGE
- + NO HINDRANCE WHEN MOUNTING
- + CAN BE USED AS HAND LUGGAGE



**BMW R 1250 GS | R 1200 GS | ADV LC****Tail bag AMBATO for the luggage rack**

BMW R 1200 GS (2013-) / R 1250 GS

Size: (L x W x H) approx. 25 x 30 x 19 cm

Volume: approx. 9 litres

045-5811

R 1200 GS Adventure (2014-)

R 1250 GS Adventure

045-5836

**BMW F 850 GS / ADV | F 750 GS****Tail bag AMBATO for the luggage rack**

BMW F 850 GS / F 750 GS

Size: (L x W x H) approx. 22 x 31 x 15/26 cm

Volume: approx. 10/17 litres

045-5811

BMW F 850 GS ADV

045-5836

**KTM 890 ADV / R | 790 ADV / R****Tail bag AMBATO for the luggage rack**

KTM 890 ADV / 890 ADV R / 790 ADV / 790 ADV R

Size: (L x W x H) approx. 25 x 30 x 19 cm

Volume: approx. 9 litres

372-5811





## KTM 1290 Super ADV | 1190 ADV/R



### Tail bag AMBATO for the luggage rack

1290 Super Adventure /  
1190 Adventure / 1190 Adventure R

Size: (L x W x H) approx. 30 x 30 x 19 cm

Volume: approx. 13 litres

371-5811



## UNIVERSAL

### Tail Rack Bag AMBATO for luggage racks

Size: (L x W x H)  
approx. 17 x 27 x 12/20 cm

Volume: approx. 4/8 litres

055-1298



### Tail bag IBARRA Sport

Dimensions:  
approx. 25 x 16/25 x 12/17 cm

Volume: approx. 5/8 litres

055-1200

### Raincover for Tail Rack Bag

Dimensions: (L x W x H) 35 x 27 x 25 cm

055-1169





## VERSATILE ADDITIONAL BAGS

- + OPTIMAL USE OF EVERY STORAGE SPACE ON THE MOTORCYCLE
- + NO RESTRICTIONS ON MOTORCYCLE
- + FAST ACCESS I.E. TOOLS
- + EXTENDED PROTECTION FOR CLADDING AND RIDER
- + PROTECTION AGAINST WEATHER AND WIND

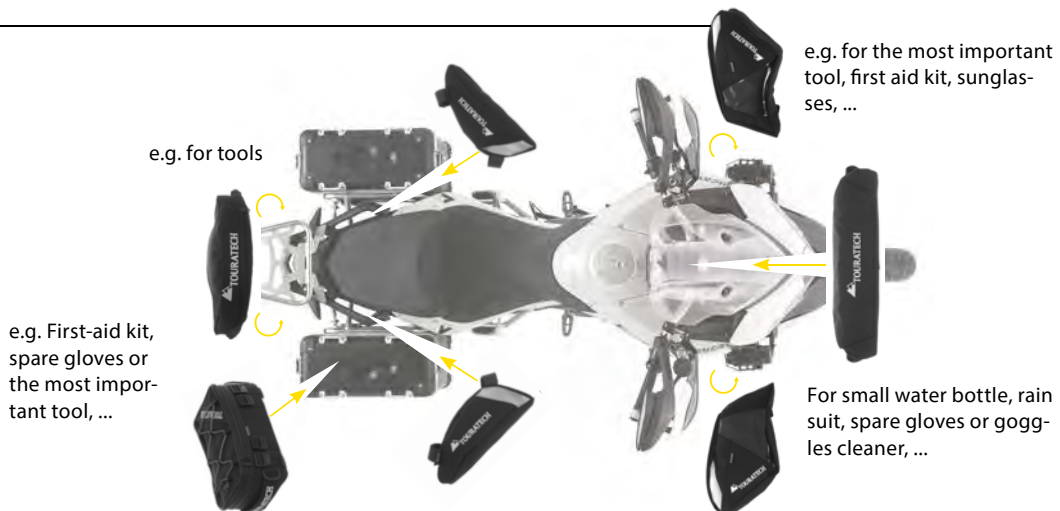



### Handlebar bag IBARRA

**Practical storage space exactly where you need it!**  
The sturdy handlebar provides enough space to attach an extremely practical and travel-worthy bag.  
Volume: approx. 2 litres

045-5827



A key feature is that our bags don't restrict the rider's movements or affect control of the bike.



### Handlebar bag IBARRA Smart

**Practical storage space and waterproof smartphone holder - always within reach!** The highlight of our „Ibarras Smart“ is the waterproof compartment for all common smartphones (up to approx. 9 x 16 cm). The use of certified Cordura guarantees highest material quality.  
Volume: approx. 2,4 litres

055-1285



### Side bags for frame triangle

BMW R 1250 GS / R 1250 GS ADV /  
R 1200 GS (LC) / ADV (LC)

Two bags that fit well and unobtrusively on the bike!

The two side bags provide additional storage space without restricting the rider's movement. And, of course, we took care to ensure passenger suitability.

The back of the bag is made of water and dirt repellent tarpaulin.

Size: (L x W x H) approx. 48 x 5 x 20 cm

045-5822





038-5816



402-5820

### Bags for crash bars





The crash bar bags have just the right amount of space, especially for those little things.

The bags are sold in pairs, and fit on the original crash bar. They are simply placed over the bar and secured by two straps.







045-5839



#### Bags for original crash bars (1 pair)

	<b>BMW R 1250 GS Adventure</b>	<b>037-5840</b>
	Size: approx. 18 x 7 x 35 cm   Volume: approx. 2 x 3 litres	
	<b>BMW R 1200 GS Adventure (-2013)</b>	<b>055-1131</b>
	Size: approx. 25 x 20 x 8 cm   Volume: ca 2,5 litres each side	
	<b>BMW R 1200 GS Adventure (2014-)</b>	<b>045-5839</b>
	Size: approx. 22 x 10 x 28 cm   Volume: approx. 2 x 2 litres	
	<b>Honda CRF 1000 L Africa Twin / Adventure Sports</b>	<b>402-5825</b>
	Size: approx. 18 x 8 x 30 cm   Volume: approx. 3 litres each side	

#### Bags for Touratech crash bars (1 pair)

	<b>Honda CRF 1100 L Africa Twin / CRF 1100 L ADV Sports</b>	<b>403-5820</b>
	Size: approx. 20 x 6 x 27 cm   Volume: approx. 1,5 litres each side	
	<b>Honda CRF 1000 L Africa Twin</b>	<b>402-5820</b>
	Size: approx. 21 x 10 x 36 cm   Volume: approx. 4,5 litres each side	
	<b>KTM 890 ADV / 890 ADV R / 790 ADV / 790 ADV R</b>	<b>372-5820</b>
	Size: approx. 32 x 6 x 18 cm   Volume: approx. 2,5 litres each side	
	<b>Yamaha Ténéré 700</b>	<b>632-5820</b>
	Size: approx. 20 x 6 x 27 cm   Volume: approx. 1,5 litres each side	

#### Bag for Touratech crash bar extension

	<b>BMW R 1200 GS ADV (2014-)</b>	<b>045-5834</b>
	Size: approx. 28 x 7 x 31 cm   Volume: approx. 2 x 5 litres	
	<b>BMW R 1200 GS (2017-) / R 1250 GS</b>	<b>038-5816</b>
	Size: approx. 37 x 20 x 7 cm   Volume: approx. 2 x 3 litres	



045-5838



### Luggage rack side bags

The space on the left and right below the pillion grab handles is just perfect for attaching two side bags meant to hold smaller equipment items. They don't get in the way at all and offer enough storage space for items such as a first aid kit, a spare pair of gloves or your most important tools.

Made of durable Cordura fabric, these bags with water-repellent zippers allow easy access to their contents and can be easily removed whenever necessary.

### Luggage rack side bags (1 pair)

**BMW R 1250 GS / R 1200 GS (2013-)**

Size: approx. 37 x 10 x 9 cm | Volume: approx. 2 x 2 litres

**045-5814**

**BMW R 1250 GS ADV / R 1200 GS ADV (2014-)**

Size: approx. 40 x 8 x 8 cm | Volume: approx. 2 x 1 litres

**045-5838**





### Bag to fit under luggage rack

This small yet practical bag fits perfectly into the space under the standard luggage rack, looking made-to-measure on its own or together with the side bags.

It attaches using strong and easy-to-fit belts, and its large, covered zip provides fast access to the contents. A small bag that's big on benefits!



### Bag to fit under luggage rack

**BMW R 1250 GS / R 1200 GS (2013-)**

Size: approx. 26 x 20 x 5 cm | Volume: approx. 1,5 litres

045-5842

**BMW R 1250 GS ADV / R 1200 GS ADV (2014-)**

Size: approx. 20 x 20 x 4 cm | Volume: approx. 1,5 litres

045-5843

**BMW F 850 GS / F 750 GS**

Size: approx. 26 x 20 x 5 cm | Volume: approx. 1,5 litres

045-5842

**TOURATECH**  
**WATERPROOF**



Waterproof EXTREME Edition

p. 548



Waterproof Rack Packs

p. 559





# WATERPROOF



Waterproof  
Endurance Bags

p. 566



Accessories

p. 570





# WATERPROOF EXTREME



## Touratech Waterproof EXTREME Edition

This new product range from Touratech combines everything you could wish for in waterproof soft luggage: These pieces of luggage are extremely robust - they can take a lot of rough treatment, even a fall. The bags are of course extremely waterproof, regardless of which direction the rain comes from. Their extremely good quality is reflected in workmanship, fit and durability.

On top of this, these bags sport an extreme design with many useful features and an unmistakable

colour scheme: black on the outside and yellow on the inside - to help you find what you're looking for more easily.

The specially developed material mix not only offers an unmistakable feel, it's both a promise and a trademark: whether onroad or off-road; UV rays, rain or snow; the EXTREME Edition from the Touratech Waterproof range does it all.

Start your adventure now with the Touratech Waterproof EXTREME Edition!



## Tank Bag EXTREME Edition

This waterproof tank bag was specially designed for large adventure motorcycles. The already large capacity of approx. 14 litres can be extended to up to approx. 22 litres by means of the all-round zip. The main compartment can be individually adjusted using the interior divider. Small items can be placed in the two net pockets on the outside or in the small additional pockets in the weather-protected interior of the tank bag. The map pocket is also waterproof, of course, and has a cable entry for a smartphone or tablet. A removable pocket offers space for your wallet, car documents, passport, visas, keys,...

The tank bag is attached in the typical Touratech manner by means of a retaining kit with clips and Velcro that remains on the vehicle. Refuelling is therefore quick and uncomplicated. The tensioning straps provide an even better hold in off-road conditions.

**055-1000**

**055-1011 Harley-Davidson R1250 Pan America**

The EXTREME tank bag is suitable for many different adventure bikes. Amongst others:

- BMW R 1250 GS / R 1250 GS ADV
- BMW R 1200 GS (LC) / R 1200 GS ADV (LC)
- BMW R 1200 GS (AC) / R 1200 GS ADV (AC)
- BMW F 850 GS / F 850 GS ADV / F 750 GS
- KTM 1290 Super ADV R / S / 1190 ADV / 1090 ADV / 1050 ADV





## WATERPROOF EXTREME



### Tank Bag Midi EXTREME Edition

With the Midi tank bag, we have created a solution in the Waterproof EXTREME edition for all adventure bikes with shorter tanks. It is fastened with straps and clips. This makes refuelling quick and uncomplicated, and a secure hold is guaranteed even in tougher terrain. The volume of 10 litres can be expanded to up to 14 litres.

055-1008



The tank bag MIDI EXTREME is suitable for many different Adventure bikes. Amongst others:

- BMW F 800 GS / F 700 GS / ADV
- HONDA CRF 1100L Africa Twin / CRF 1100L ADV SPORTS
- HONDA CRF 1000L Africa Twin / CRF 1000L ADV SPORTS
- KTM 790 ADV
- TRIUMPH Tiger 900 / Tiger 800
- YAMAHA Ténéré 700







### Tail Rack Bag+ EXTREME Edition

This waterproof tail rack bag+ was specially designed for Touratech luggage racks, but also fits most standard luggage racks. Thanks to the extra-long straps, the bag can also be mounted on almost any pillion seat. The already large capacity of approx. 8 litres can be extended to up to 12 litres by means of the all-round zip. On the top flap and on the weather-protected inside of the top flap, there are mesh pockets that hold small items. The reflector on the back offers passive safety.

055-1006





TOURATECH

WATERPROOF



EXTREME EDITION



### Pillion seat bag EXTREME Edition

The waterproof pillion bag is the perfect luggage supplement for the solo adventurer. With the robust Velcro straps, the bag can be universally attached to almost any pillion seat. On the top flap and on the weather-protected inside of the top flap, there are mesh pockets that hold small items. The reflector on the back offers passive safety. The already large capacity of approx. 12 litres can be extended to up to approx. 18 litres by means of the all-round zip. The main compartment can be individually adjusted using the interior divider.

The pillion seat bag instead of seat version (055-1010) includes a base plate that, when inserted into the special bag, allows the pillion bag to be used without a pillion seat. Mounting becomes more comfortable and the sporty silhouette of your motorbike is maintained (suitable for BMW R 1250 GS / ADV and R 1200 GS (LC) / ADV).

055-1009 Pillion seat bag

055-1010 Pillion seat bag instead of seat

055-1010



**WATERPROOF**



### Saddle Bags EXTREME Edition

We have designed these saddle bags especially for medium-sized enduro and adventure bikes. They are the alternative to the pannier system and, with a capacity of 2 X 20 litres, they offer enough space for your next tour. These bags allow weight-optimised loading with a low centre of gravity, which has a positive effect on the handling of the motorcycle - especially off-road. The roll closure keeps the contents dry and clean. Drinking bottles or chain spray can be stowed away in the additional outside pockets. The strap fastening enables them to be mounted on almost every bike. If the exhaust pipe is raised, we recommend using the heat shield muffler (080-5055).

055-1003

WATERPROOF  
**EXTREME**



**WATERPROOF**



## Rack Pack EXTREME Edition

This rack pack with its tried and tested roll closure keeps the contents absolutely waterproof and is the all-time favourite of every adventure biker. The inside pockets allow quick access to notebooks and other small items without you having to first take out your entire laundry for the trip.

The mesh pocket on the outside holds things that don't necessarily have to be water-protected but must be ready to hand. The reflectors on the sides offer passive safety. With a capacity of 50 litres this bag offers enough space for your next tour. The optional carrying strap (055-1621) transforms it into a universal travel bag.

055-1002



WATERPROOF  
**EXTREME**



## Pannier Lid Bag EXTREME Edition

This waterproof pannier lid bag can be mounted on all Touratech panniers, all BMW panniers and most other original panniers with attachment eyes. With a capacity of 10 litres, it is the perfect addition to the Touratech ZEGA pannier system. On the top flap and on the weather-protected inside of the top flap, there are mesh pockets that hold small items.

055-1004



## WATERPROOF EXTREME



## Additional Bag+ EXTREME Edition

There is space for this waterproof additional pocket on every bike - whether on the crash bar, on the fender, as a tail rack bag on a small enduro, or on a ZEGA pannier with the matching holder. With the extra-long straps, mounting is no problem. The roll closure keeps the contents safe and dry. With a capacity of 3 litres, this bag offers enough space for your first aid pack, warning vest or breakdown kit. Small items can be stowed away in the net bag on the outside, ready to hand.

055-1007





## Touratech Waterproof Bags for original crash bar

### BMW R 1250 GS ADV

Waterproof storage space on your motorcycle - whether you're just off for a short ride after work, or using it as a replacement for a tank bag that is much too large, or as a luggage supplement on a round-the-world trip - is always useful! Touratech Waterproof crash bar bags are welded to make them waterproof and dustproof. You are already familiar with the robust, non-sensitive material of our Rack Packs, a double layer of which is used in the production of these crash bar bags.

With 2 x 3 litres of packing volume, these bags offer enough space for your wallet, papers, snacks or other small items.

The water-protected YKK brand zip can be easily operated even when wearing thick gloves. The extra-large zip garage effectively prevents rain-

water, carried on the air stream, from penetrating. The vehicle-specific Velcro straps make it child's play to attach the bags absolutely securely to the fairing crash bar. You can find contents quickly, thanks to the yellow interior. Your contents are additionally protected through the doubling of the material.

The design of the crash bar bag blends discreetly with the lines of your R1250GS Adventure. The reflective strip increases your passive safety through better visibility - an unbeatable plus, especially in the rain and in the dark.

As a set for both sides.

Dimensions: (L x W x H) approx. 18 x 6 x 34 cm

Volume: approx. 2 x 3 litres.

**037-5841**



# ADVENTURE \_RACK PACK

## Dry bag Adventure Rack-Pack

by Touratech Waterproof

The absolutely waterproof, dustproof, mudproof, snowproof and sandproof dry bag by Touratech Waterproof. This strong bag has a large transverse roll closure that enables you to see all the equipment clearly.

The extremely resistant plastic fabric protects against abrasion and unwanted kinks. Robust, fixed lashing strap eyelets simplify the lashing of the Adventure Rack-Pack on the motorcycle. Additional belt feed-throughs enable equipment to be attached with optional tension belts.



# MADE FOR ADVENTURE.

Size	M	L	XL
Height in cm	30	34	40
Width in cm	54	61	71
Depth in cm	27	32	40
Volume in Liter	31	49	89
Weight in g	850	1000	1200

	M - 31 L	L - 49 L	XL - 89 L
black	055-3240	055-3241	055-3242
yellow/black	055-3001	055-3002	055-3003
orange/black	055-3016	055-3017	055-3018
blue/black	055-3021	055-3022	055-3023
red/black	055-3026	055-3027	055-3028
silver/black	055-3243	055-3244	055-3245



**Dry bag MOTO, black,  
by Touratech Waterproof**

The dry bag for heavy duty use!

The waterproof, dustproof dry bag MOTO is constructed from extremely wear and crease-resistant material to Ortlieb's tough quality standards. It is filled from the top in classic style. The dry bag has a built-in valve which makes it easier to compress the 35 litres pack volume.

35 L	055-3120
59 L	055-3121



**Dry bag PD350 with roll closure**

by Touratech Waterproof

- Buckles with two D-rings for securing or locking
- Base loop for fixing or holding during unpacking
- Easy to clean inside

	black
59 L	055-3077
79 L	055-3078

**Inner bag with valve for panniers, black**

by Touratech Waterproof

Specially designed inner bags for all Touratech case systems, manufactured to wellknown high quality standards. The valve fitted to the top enables squeezing out even the last remaining air when rolling the bag together; this allows the bag to fit every case, topcase, rucksack, leather bag, etc. without losing valuable storage space.

Volume: approx. 50 litres

- fits every case
- for universal use
- 100% waterproof
- integrated ventilation valve
- proven roll zipper

050-0851







## Dry bag PS17

by Touratech Waterproof

- fits every case
- for universal use
- 100% waterproof
- proven roll zipper

	black
3 L	055-3060
5 L	055-3061
7 L with valve	055-3062
10 L with valve	055-3063
13 L with valve and patch	055-3064



## Backpack Light Pack Two

by Touratech Waterproof

Lashed to your motorbike as a luggage roll, or as a backpack that is always with you: the Light Pack Two is the ideal luggage supplement for your next motorbike adventure.

- High-value backpack with waist and breast strap (adjustable and removable)
- Usable as luggage roll
- Waterproof (IP64)
- Designed for universal use
- Minimal pack size
- Extremely robust
- 25 litre capacity
- Only 290 g
- Incl. mesh bag

055-3209





# PURE SADDLEBAG EVERYTHING YOU NEED!



TOURATECH

WATERPROOF



## DISCOVERY

It couldn't be easier to start off on an adventure! The Discovery is the universal soft luggage alternative to the ZEGA pannier system.

Without a pannier rack, this luggage system fits on almost every motorcycle. You will find appropriate lashing points for the 4 straps with which to fix the Discovery on every bike.

As with horses, the saddlebag is thrown over the bike behind the rider and can be lashed down quickly and securely. Due to the preformed basic design, it fits snugly and flutter-free on your motorcycle.

The two waterproof slide-in bags can easily hold up to 25 litres of luggage each. Thanks to the stable base plates, these bags are super easy to fill. The roll closure, proven a million times over, keeps the contents protected against any kind of weather conditions and serves as a carrying handle. Even when overfilled and bulging, packsacks can be easily pulled into the robust system bag by means of pull loops and can be additionally secured with the clip strap.





The two external pockets with roll closures can be used to stow first aid kits, oil bottles, rain gear or other items that you may need to reach quickly. The volume of approx. 7.5 litres each offers more than enough space for these.

- Super simple soft luggage system
- Fits universally on almost every motorcycle
- Approx. 50 litres of waterproof luggage volume thanks to two packsacks
- Approx. 15 litres of extra volume due to two additional pockets with roll closures
- Integrated lashing possibilities for optional rack pack, tent, etc.
- Two large mesh pockets on the inside of the lid, each with zip fastener

**Throw it over, lash it down, ride off!**

For raised rear silencers, we recommend the use of our heat shield 080-5055.

Include them in your order now: straps 055-1608



The three rows of straps in the middle section of the system allow you to tie down a rack pack, tent, sleeping mats or other items of luggage. The large lids with their clip straps hold additional luggage on the pillion seat without allowing any wobbling or slipping. The two mesh pockets in the lid hold maps, a high-visibility vest or other small items.

Although designed for solo adventurers, in an emergency, a pillion passenger can ride with you. This is possible because, without the optional rack pack, the smooth lid offers a passable seating surface.



# DISCOVERY BLACK



055-1288



**WATERPROOF**

**MADE FOR ADVENTURE.**

Discovery luggage system,  
by Touratech Waterproof

055-1284

055-1288 Black Edition



# ENDURANCE

# \_CLICK

*Light and waterproof!*



## Side bag ENDURANCE Click

by Touratech Waterproof

Quick on - quick off and just the right size! It's not just off-road riders world-wide who have been waiting for this: A super lightweight and waterproof soft luggage system for all common luggage racks.

The Side bag ENDURANCE Click is the first real alternative to aluminium cases. It is lighter than any plastic case, yet durable and completely waterproof (IP64). With a capacity of around 28 litres it can accommodate a lot! Thanks to the automatically locking fixture system the bag is easy to use and adapts to any standard bike rack with 18 mm tube diameter. If your luggage rack is a different size, that is no problem at all. With our optional kits you can fit your new bag to your existing luggage rack.

Thanks to the innovative locking system, your bag is firmly attached to the luggage rack of your motorbike while you're travelling. By simply lifting the bag by the handle, it automatically unlocks and can be removed from your motorbike without any complicated undoing of straps. Let us convince you of the functionality of our Side bag ENDURANCE Click: like all products of the Touratech Waterproof series, this bag is made of highly abrasion-resistant and waterproof fabric and looks really good into the bargain. Whether on an off-road tour or in everyday life - this bag's proven watertight, practical roll closure protects your luggage from water, dust and dirt. Held by the padded carrying handle or simply slung over your shoulder, when you're on foot, your bag is always at hand. The interior organiser pocket even makes your new Side bag ENDURANCE Click a faithful companion on the way to the office or to casual business meetings.

The Touratech design includes 3M Scotchlite reflectors which ensure passive safety. And should your bag get dirty when you're out and about, a garden hose is perfectly adequate for cleaning it!

*For pannier racks!*



### Further practical details:





- Automatically locking fixture system for all straight luggage racks with a tube diameter of 18 mm (Touratech, BMW, Ducati, Givi, etc.)
- Waterproof (IP64)
- Perfect for off-road conditions: doesn't dent, hard to break, less injury should the bag fall on the rider at some point
- Available in five colour variations
- Ideal alternative to a luggage system for everyday use
- Includes interior organiser pocket
- Large 3M Scotchlite reflectors on both sides
- Easy to clean
- Kits for alternative tube diameters are optionally available

**We recommend a minimum distance of 10 cm to the exhaust pipe!**

Height: 31 cm, Width: 43 cm, Depth: 18 cm

Weight: 1470 g

Capacity: 28 litres

color	single	pair
	055-3180	055-3185
	055-3181	055-3186
	055-3182	055-3187
	055-3183	055-3188



**Spare part mounting kit 18 mm for side bag ENDURANCE Click, by Touratech Waterproof**

055-3109

**Kit for alternative tube diameters 8-10-12-16 mm**

055-3108





# ENDURANCE

## \_VELCRO



### Saddle bags ENDURANCE Velcro

(pair), by Touratech Waterproof

The „soft“ luggage system that’s also suitable for heavy use on your touring bike.

The ENDURANCE Velcro saddle bags are waterproof, dustproof twin saddle bags. They feature a roll-up closure – which has proven itself time and time again over the years – made from extremely wear and crease-resistant material. These saddle bags can be used on very many different motorcycles. Generally an extra luggage rack is not required.



However, they should be kept at least 10 cm away from the exhaust. To ensure stability on the bike, the bags must be used as a pair. With their wide Velcro closures, lashing straps and sturdy bracing inside the bags, this luggage system can be attached safely and securely to your motorbike. The symmetrical design also leaves enough space for two to ride on the bike.

Size: ( l x b x w ) 38/28 x 33 x 21 cm

Volume: 52 litres

Weight: approx. 2,1 kg

**When fitted, the bags must clear the exhaust by at least 10 cm!**

color	item number
	055-3105
	055-3176



### Heat shield muffer, stainless steel

Avoid the meltdown - prevent bags and side panels from touching your bike’s exhaust! The heat shield by Touratech is the simple, lightweight, universal heat problem-solver for virtually any motorcycle exhaust system.

- The perfect addition to your new Touratech Waterproof bag
- Rugged stainless steel construction
- Easy to install
- Fits virtually any motorcycle make/model
- Dimensions: 15 x 7 cm
- Stainless steel hose clamp up to 65 cm

080-5055





## Folding bowl, 50 litres, yellow

by Touratech Waterproof

Colour: yellow

Size: (L x W x H) 62 x 42 x 20 cm

Weight: 750 g

055-3201



## Waterbag, black

by Touratech Waterproof

Extremely lightweight and durable water sacks with wide closure and valve for regulating liquid flow.

With the shower attachment (accessory) the water bag becomes a simple outdoor shower.

10 L 055-3202



## Waterbag showering resolution, black

055-3204



## Document bag, transparent

by Touratech Waterproof

Perfect for safe storage of maps, passports and other important documents while travelling. Also suitable for electronic devices such as GPS, cell phone or MP3 player.

S	DIN-A6	055-3210
M	DIN-A5	055-3211

## Additional bag

by Touratech Waterproof



Can be attached to the Rack-Pack and Travel Zip bags or used as a side pocket. Use these bags for small items that would otherwise get lost in large pack bags. It is also useful for storing the first-aid kit so that it is readily available. The sophisticated fastening system enables the bag to be removed quickly with no tools.



	S - 2 L	L - 3,5 L
High Visibility	055-3143	055-3142
black	055-3140	055-3141

## Rain cover for tank bag

by Touratech Waterproof

color	item number
	055-3132
	055-3133



## PacSafe steel net for luggage

This strong, flexible steel net prevents your luggage being stolen when you're travelling.

for RackPack M | Weight: 500g

055-0108

for RackPack L | Weight: 580g

055-0109





NEW IDEAS FOR MOTORBIKES

**TOURATECH**



**WHY DO I NEED A  
TOURATECH SEAT? ►**

**◀ BECAUSE RIDING MY  
BIKE SOON BECOMES  
UNCOMFORTABLE**



# SEATS

SITZBÄNKE

SELLES

SELLE

ASIENTOS

Fresh Touch

p. 580

Dri Ride

p. 584





**WE TAKE YOU FURTHER FOR LONGER.**





# PROFESSIONAL TOURING-SEATS

## For the most comfortable ride over long distances

Touratech seats are already available for many models of bikes. They're made of the highest quality materials and are specially designed to meet the ergonomic demands posed by long-distance touring. This means that pressure points caused by poorly designed padding or incorrectly located seams are avoided right from the start, thus ensuring comfortable seating over the long haul. A special foam core, made extra carefully by hand and designed to best fit the rider's anatomy, ensures that weight and forces are evenly distributed to prevent pressure sores – even after many, many kilometres.

In addition to their perfect shape, the comfort of the seats developed especially for Touratech is greatly increased by their bi-elastic upholstery fabric. Its surface improves grip when braking and accelerating and also reduces sweating. The result: The rider sits far more securely on the motorcycle and has better control in any

situation. Even if other materials may look the same, they still don't offer these critical features! The seams of our extra-comfort seats are specially treated to be 100% waterproof; the taut upholstery fabric doesn't allow rainwater to collect on it; instead, it just runs right off. Our seats can also be used as separate modules because they fit right in with original-equipment passenger or rider seats. At the same time, the contours of the rear, pillion seats prevent the passenger from sliding forward.

For many models, we also offer our seats covered in a patented "breathable" fabric, which much like modern motorcycle clothing lets moisture out yet is still waterproof. It's the best solution for coping with heat and humidity, for it keeps underclothing from riding up, shifting, sticking and forming those pressing and painful folds and ridges. Tests in Namibia, Bolivia and Mexico have conclusively demonstrated greatly increased comfort in hot weather.

## WHY NO GEL SEATS?

In the process, Touratech is deliberately refraining from using gel pads as they prevent the air exchange in the seating area and lead to more sweating. In addition, gel is temperature-sensitive; it will become hard and uncomfortable at low temperatures and soft and

spongy when it's hot. All of this affects riding and the sitting comfort drastically. With the Touratech seats, an optimal distribution of forces is obtained by the outlines of the foam core identified by conducting tests.





## DEFINITION OF SEAT HEIGHT

In order to compare the heights of our seats with that of your motorbike, we have specified the heights measured from the (original) footrest (removable foot rest rubbers not included) vertically to the lowest point of the seat.

In this way you can compare the seats regardless of the model year, frame, frame adjustment and wheels and tyres fitted.



## TEST RIDES AND ADVICE

Next to extensive advice we can offer seats for a test run at many locations. Our experts are at your service.

info@touratech.de or +49 (0)7728 92790

Our support bases and the respective country representatives can be found from page 4 together with all the contact data.





# WHY IS TRAVELING ON A BIKE WITH TOURATECH SEATS MORE FUN?

- Anatomically shaped contours
- Available in different heights
- No modifications to bike necessary
- Special contour prevents sliding during acceleration and braking
- Complete and ready for fitting
- Optimal positioning of seams | sealed seams
- Optimized foam core gives high stability
- Groove for relief of coccyx
- Bi-elastic cover material, water-proof
- Robust and extremely durable
- Standard adjustment of seat height is retained



## ERGONOMICS & LOWERING

For the most comfortable ride over long distances.

Even the most terrific and exciting motorcycle tour can become pure torture if your seat isn't what it really should be. How can you be expected to enjoy a relaxed view of beautiful countryside when your sweaty skin has gotten so sore in the worst places from bunched-up, chafing clothing caused by a poorly designed seat? Seats from Touratech, which are developed and manufactured in southern Germany in close collaboration with the experts at CREW68, are the cure

for this problem. They ensure a most comfortable ride even over long distances.

Depending on the size of the rider and the intended use, Touratech offers seats in various heights and designs. For instance, for just an R 1200 GS alone, we offer five different types of seats. You're sure to find exactly what you need, and you'll really feel the difference!

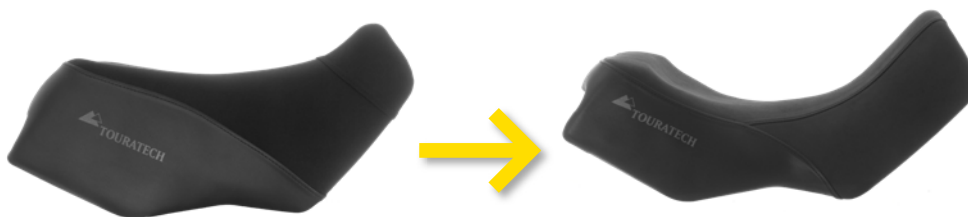

NO MATTER IF WANT TO LOWER OR RAISE THE SEAT,  
OUR EXPERTS ARE PLEASED TO HELP YOU: +49 7728 92790





# Which Touratech seat...

COMFORT SEATS **FRESH TOUCH**  
FOR RIDER AND PASSENGER...



**FRESH TOUCH**

**BREATHABLE SINGLE  
AND SPORT SEATS...**



**TOURATECH** **Dri Ride**  
BREATHABLE SEAT TECHNOLOGY

...for my needs?



...for touring and traveling  
in temperate climates

- Maximum long-distance comfort
- Rider, pillion and one piece
- Handmade in Germany
- Various heights

**p. 580**



...for traveling to  
warm countries

- Highest level of comfort in  
warm temperatures
- Rider, pillion
- Handmade in Germany
- Various heights

**p. 584**



Up to 10 °C difference with the original seat fabric thanks to the surface coating Fresh Touch.

# FRESH TOUCH SEAT COVER

The high quality, multi-layer seat cover is e-quipped with a durable Fresh Touch surface coating. It reduces the surface temperature by significantly reflecting infrared light radiation and providing a cooler feeling when mounting a motorcycle parked in the sun.

An additional, exclusive gain in comfort for your riding pleasure!



INFRARED LIGHT



-10 °C | -50 °F

with Fresh Touch-cover

Model	Low	Standard	High	Pillion
<b>F 800 / 700 / 650 GS (Twin)</b> Comfort seat one piece, Fresh Touch	Height: 50 cm 048-5962	Height: 52 cm 048-5963	Height: 54 cm 048-5964	
<b>F 800 GS ADV</b> Comfort seat one piece, Fresh Touch	Height: 52,5 cm 048-5900	Height: 55,5 cm 048-5901	Height: 60 cm 048-5902	
<b>F 850 GS / F 850 GS ADV / F 750 GS</b> Comfort seat one piece, Fresh Touch	Height: 54 cm 082-5912	Height: 56 cm 082-5913	Height: 58 cm 082-5914	
<b>R 850 / 1100 / 1150 GS</b> Comfort seat one piece, R 1150 GS Adventure		041-5913	041-5914	
Comfort seat (not for Adventure)	Height: 46/48 cm 041-5900	Height: 48/50 cm 041-5901	Height: 51/53 cm 041-5902	041-5907
<b>R 1200 GS (-2012) / ADV (-2013)</b> Comfort seat, Fresh Touch	Height: 50/52 cm 044-5950	Height: 51/53 cm 044-5951	Height: 54/56 cm 044-5952	044-5957
Comfort seat, Fresh Touch	<b>X-low: 48 cm</b> 044-5949			
Comfort seat one piece, Fresh Touch		Height: 54 cm 044-5963	Height: 57 cm 044-5964	
<b>R 1250 GS / ADV   R 1200 GS (2013-) / ADV (2014-)</b> Comfort seat, Fresh Touch	Height: 50,5/52 cm 045-5950	Height: 53/54,5 cm 045-5951	Height: 54,5/56 cm 045-5952	045-5957
Comfort seat, Fresh Touch	<b>X-low: 47/48,5 cm</b> 045-5949			
Comfort seat one piece, Fresh Touch	Height: 50 cm 045-5962	Height: 54 cm 045-5963	Height: 56 cm 045-5964	





HONDA

Model	Low	Standard	High	Pillion
<b>CRF 1000 L Africa Twin/ Adventure Sports</b>				
Comfort seat, Fresh Touch	402-5950	402-5951	402-5952	402-5958
Comfort seat one piece, Fresh Touch	402-5962	402-5963	402-5964	
<b>CRF 1100 L Africa Twin/ Adventure Sports</b>				
Comfort seat, Fresh Touch	403-5962	403-5963	403-5964	
<b>Honda Crosstourer</b>	<i>Height: 47 cm</i>	<i>Height: 50 cm</i>	<i>Height: 52 cm</i>	
Comfort seat, Fresh Touch	406-5962	406-5963	406-5964	

KTM

Model	Low	Standard	High	Pillion
<b>690 Enduro / Enduro R / SMC</b>				
Comfort seat one piece		<i>Height: 54 cm</i>	<i>Height: 57 cm</i>	
<b>790 ADV/R, 890 ADV/R</b>				
Comfort seat one piece, Fresh Touch	372-5962	372-5963	372-5964	
<b>1050 ADV, 1090 ADV, 1190 ADV/R, 1290 Super ADV (-2020)</b>				
Comfort seat, Fresh Touch	<i>Height: 51/52 cm</i>	<i>Height: 53/54 cm</i>	<i>Height: 55/56 cm</i>	
	371-5950	371-5951	371-5952	371-5957
Comfort seat one piece, Fresh Touch	<i>Height: 52 cm</i>	<i>Height: 54 cm</i>	<i>Height: 56 cm</i>	
	371-5962	371-5963	371-5964	
<b>1290 Super ADV (2021-)</b>				
Comfort seat one piece, Fresh Touch	373-5962	373-5963	373-5964	

YAMAHA

Model	Low	Standard	High	Pillion
<b>XT 1200 Z Super Ténéré</b>				
Comfort seat, Fresh Touch	<i>Height: 51/53 cm</i>	<i>Height: 54/56 cm</i>	<i>Height: 57/59 cm</i>	
	046-5950	046-5951	046-5952	046-5957
<b>Ténéré 700</b>				
Comfort seat one piece, Fresh Touch	632-5962	632-5963	632-5964	







Stay dry with Touratech's exclusive breathable seat technology. Your riding gear is designed to allow moisture to escape your body but it can't do its job in the most important area unless you have a seat that breathes.

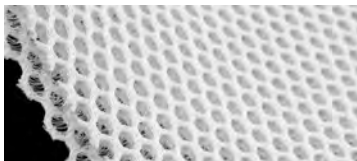

1

Touratech Vapor-Flow™ Technology allows your body's moisture to pass through your riding gear, down through the seat fabric and into the breathable membrane. The moisture then escapes through the sides of the seat, leaving you dry and comfortable.



2

Although the seat is breathable (allowing moisture vapor to pass through the fabric) the tight structure of the Rain-Block™ Fabric forces water droplets to bead up and roll off the seat. It's waterproof.

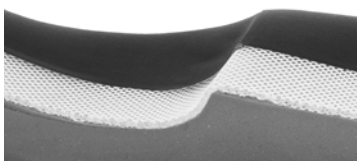

3

Touratech has developed Ergo-Response™ Long-Distance Foam, which is tuned for comfort and designed to hold you in the optimal riding position. Ergo-Response™ technology keeps you on top of the saddle, not sunken down into it. The foam core is sculpted in a way that ensures there's no pressure on the coccyx (tail-bone) and your weight is supported evenly for all-day comfort. The longer you ride, the better it feels.

DriRide™ Breathable Seats are available for many motorcycles, in various heights and also in passenger models.



## BMW

Model	Standard	High	Pillion
-------	----------	------	---------

**F 800 / 700 / 650 GS (Twin)**

Comfort seat one piece	048-5916	048-5917	
------------------------	----------	----------	--

**R 850 / 1100 / 1150 GS**

Comfort seat	041-5904	041-5905	041-5910
--------------	----------	----------	----------

**R 1250 GS / ADV | R 1200 GS (2013-) / ADV (2014-)**

Comfort seat	045-5904	045-5905	045-5910
--------------	----------	----------	----------

Comfort seat one piece	045-5916	045-5917	
------------------------	----------	----------	--

**R 1200 GS (-2012) / ADV (-2013)**

Comfort seat	044-5904	044-5905	044-5910
--------------	----------	----------	----------

Comfort seat one piece	044-5916	044-5917	
------------------------	----------	----------	--

## HONDA

Model	Standard	High	Pillion
-------	----------	------	---------

**CRF 1000 L Africa Twin/ Adventure Sports**

Comfort seat	402-5904	402-5905	402-5911
--------------	----------	----------	----------

Comfort seat one piece	402-5916	402-5917	
------------------------	----------	----------	--

**Crosstourer**

Comfort seat		406-5917	
--------------	--	----------	--



402-5916

## KTM

Model	Standard	High	Pillion
-------	----------	------	---------

**1050 ADV, 1090 ADV, 1190 ADV/R, 1290 Super ADV (-2020)**

Comfort seat one piece	371-5916	371-5917	
------------------------	----------	----------	--





NEW IDEAS FOR MOTORBIKES

**TOURATECH**



Why a windscreen by Touratech?

---

**p. 590**

Product overview

---

**p. 593**

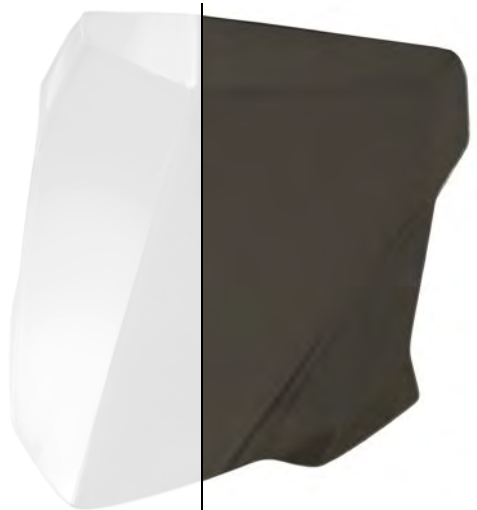

*MADE BY  
TOURATECH*

# WIND SCREEN

WINDSCHILDE  
BULLE  
PARAVENTO  
PARABRISAS



Not satisfied with the original wind shield of your bike? Thanks to countless miles of adventure experience and to the know-how of our production department, we developed a wind shield that unites an appealing adventure design and an optimal function for every application.

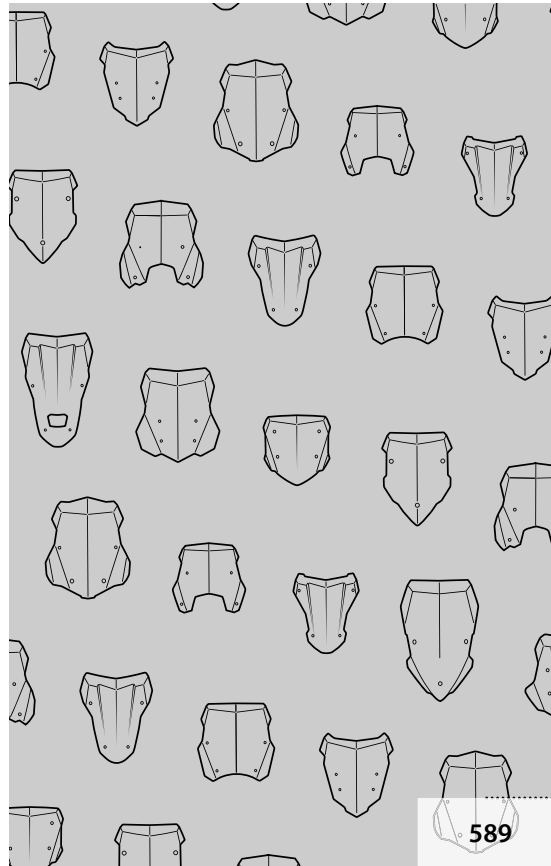



# Why a windscreen by Touratech?

- Better wind protection
- Less turbulences
- More riding comfort
- Less influence of the weather conditions
- Less soiling
- More endurance on long tracks and/or at high speed
- Possibility to choose it according to your body height

Replace your original windscreen with the Touratech wind shield and discover much better driving properties! The form and function of the upper edge of the wind shield is based on our rally experience. The aerodynamic optimization guides the air streams over the head of the pilot without unnecessary turbulences. So, the wind shield is not only flatter-free, it also guarantees a relaxed driving pleasure that doesn't exhausts the pilot nor the pillion passenger.



# 1

- Different heights to choose from (up to 3 variants)
- Adjustment is retained



## 2

- Protection against gravel / TÜV-certified
- UV-resistant
- Shatterproof acrylic glass up to  $70 \text{ N/mm}^2$



## 3

- Aerodynamics optimized
- Computer aided wind tunnel test



## 4

- Developed by riders
- Tested and approved by thousands of riders
- Made in the EU / Germany

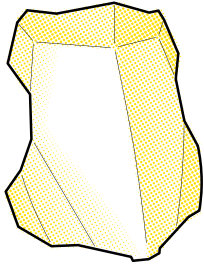

The Touratech wind shield gives your bike an individual design that will fascinate you. Of course, we tested the wind shield thoroughly for your machine. Thus you get a wind shield that improves your bike both technically and visually.

- Especially developed for your bike
- Aerodynamically optimised form
- Flatter-free even at high speeds
- Minimized air turbulences
- Non-exhausting driving
- Cool adventure design

**WIND SCREEN  
NON-TINTED  
SIZE L**



**WIND SCREEN  
TINTED  
SIZE L**



**WIND SCREEN  
NON-TINTED  
SIZE M**



**WIND SCREEN  
TINTED  
SIZE M**



**WIND SCREEN  
NON-TINTED  
SIZE S**



**WIND SCREEN  
TINTED  
SIZE S**





## PRODUCT OVERVIEW

BMW

Model	Screen non-tinted, Size L	Screen non-tinted, Size M	Screen non-tinted, Size S	Screen tinted, Size L	Screen tinted, Size M	Screen tinted, Size S
F 800 GS	<b>048-0370</b>			<b>048-0372</b>		
F 850 GS, F 750 GS	<b>082-6220</b>			<b>082-6222</b>		
S 1000 XR			<b>606-6200</b>			
R 1200 GS (2014-) / R 1200 GS ADV (2014-) R 1250 GS / ADV	<b>038-6220</b>	<b>038-6210</b>	<b>038-6200</b>	<b>038-6222</b>	<b>038-6212</b>	<b>038-6202</b>

For your R 1200 GS (2013) you also need the mounting kit 045-5349

HONDA

Model	non-tinted, Size L	non-tinted, Size M	non-tinted, Size S	tinted, Size L	tinted, Size M	tinted, Size S
CRF 1000 L Africa Twin	<b>402-6220</b>	<b>402-6210</b>	<b>402-6200</b>	<b>402-6222</b>	<b>402-6212</b>	<b>402-6202</b>
CRF 1100 L Africa Twin	<b>403-6220</b>	<b>403-6210</b>	<b>403-6200</b>	<b>403-6222</b>	<b>403-6212</b>	<b>403-6202</b>
CRF 1100 L Adv Sports	<b>403-6250</b>	<b>403-6240</b>	<b>403-6230</b>	<b>403-6252</b>	<b>403-6242</b>	<b>403-6232</b>

For your CRF 1000 L Africa Twin Adventure Sports you also need the mounting kit 402-6230

**402-6230** Mounting kit for CRF 1000 L Adventure Sports

DUCATI

Model	Screen non-tinted, Size L	Screen tinted, Size L
Multistrada 1200 (2015-) Multistrada 950 (-2016)	<b>619-6220</b>	<b>619-6222</b>

KTM

Model	Screen non-tinted, Size L	Screen tinted, Size L	Screen tinted, Size S
1190/1090/1050	<b>371-6220</b>	<b>371-6222</b>	<b>371-6202</b>
1290 (-2016)			<b>371-6202</b>



**KTM**

### **Windshield MRA Touring windscreen**

**KTM 790 Adventure / 790 Adventure R / 890  
Adventure / 890 Adventure R**

The MRA touring windscreen is 11 cm longer than the sports windscreen. Behind it, the rider is protected from wind pressure and loud turbulence. The windshield is colourless.

Length in mm: 420

Width in mm: 400

With ABE

Not mountable in combination with a handlebar riser and the GPS handlebar bracket above the instruments (372-5415).

**372-0880**

### **YAMAHA**

Model	non-tinted, Size M	tinted, Size M	tinted, Size S
XT 1200 Z (2014-)	<b>039-6210</b>	<b>039-6212</b>	<b>039-6202</b>



### **Windshield MRA Touring windscreen**

**Yamaha Ténéré 700**

With its 204 kg, the slim waisted and high Ténéré is light-weight, has a wonderfully smooth steering behaviour and is fun as a travelling companion and as a sports friend.

The 40 cm long MRA touring windscreen offers good wind protection in every situation. No separate installation material required – simply reuse the original screws for installation. The touring windscreen is colourless.

Length in mm: 400 (=OEM+100 mm)

Width in mm: 300

With ABE

**632-0880**



NEW IDEAS FOR MOTORBIKES  
**TOURATECH**

# EVO

Windscreen spoiler  
 with ABE



Whether you need it for your original windscreen or as accessory to your new Touratech windscreen - with Touratech's windscreen spoiler Evo, you absolutely gain extra comfort on each terrain.

Evo offers the right balance between protection and ventilation - whether you drive on motorways, roads or off-road. Height, inclination and distance to the windscreen can easily be adjusted - you do not need any tools.

If you are going fast and the weather is rainy, fasten the spoiler at its highest level to benefit from an effective wind and weather protection. It is a noticeable relief for your head and upper body, and wind noises in your helmet are significantly reduced.

If you set the lowest level, the windscreen spoiler almost disappears. This guarantees maximum ventilation when riding off-road.

The „bended“ 3D form does not only adapt optimally to the windscreen design of modern bikes, it also guarantees optimum airflow and thus significantly less turbulence. An additional airflow between spoiler and windscreen is generated. This airflow minimizes the turbulences being produced at the end of the windscreen.

Thanks to laterally fixed holders, the central field of view is not impaired. Additional, undesired turbulences are also prevented. The spoiler can easily be fixed on every windscreen, is steady on every track and can be removed again tracelessly, if necessary.

With ABE (for original windscreens of various manufacturers)

Windscreen width: 26 cm

Windscreen height: 10 cm

**040-1380 non-tinted**

**040-1381 tinted**



E1

p. 598

TRAVEL

p. 604



Complete information:  
[www.touratech-suspension.com](http://www.touratech-suspension.com)



**TOURATECH**  
**SUSPENSION**



URBAN

p. 622

SUSPENSION CHECK

p. 627

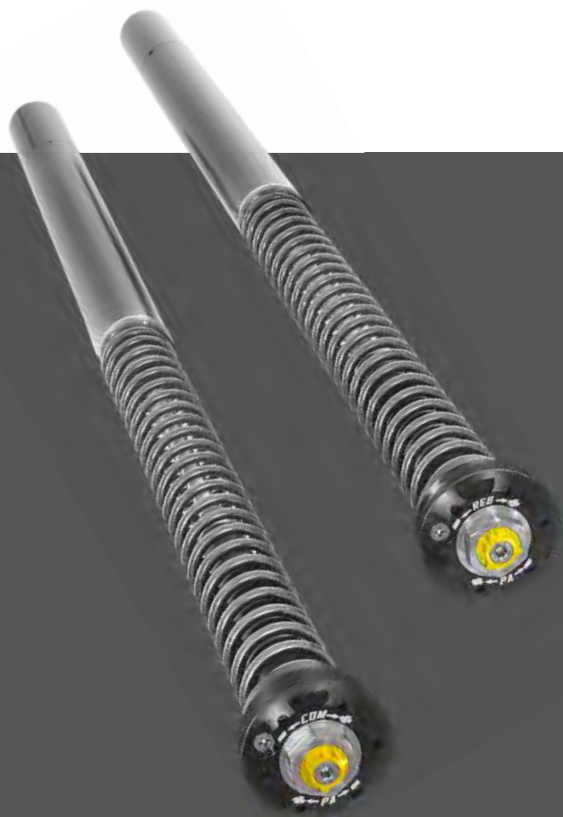



**TOURATECH**  
SUSPENSION

**E1**



**TOURATECH**  
SUSPENSION

**TRAVEL**



**TOURATECH**  
SUSPENSION

**URBAN**

## E1

- + Shock absorbers offer the perfect introduction to professional suspension optimisation.
- + Available for the latest street bikes, adventure bikes and evergreens – which means for many models from the last five decades.
- + E1 stands for robust, well thought-out and high-quality products at a fair price.
- + E1 mono shock and twin shocks.

## TRAVEL

- + Suspensions made for Adventure & Tour motorbikes
- + With ideal properties for weekend tours, riding with a partner and/or large amounts of luggage on a long-distance journey, whether off-road or on
- + Ready to ride on delivery, with the Touratech setup for your motorbike

## URBAN

- + Suspension made for Urban Bikes. Scramblers are the root of Touratech Adventure Bikes
- + High performance and the highest quality, developed for maximum riding dynamics, ensure the best of riding pleasure
- + Black-T suspension systems can be adjusted to fit your custom bike. Look & Feel is a classic design with the most advanced suspension technique





# FOR MORE THAN 250 MODELS

Touratech Suspension has significantly expanded its portfolio once again. In addition to the tried-and-tested Travel and Urban product lines, the E1 series augments the product range as a third pillar. With the E1 products, high-quality suspension elements become available at reasonable prices for an enormous range of different motorcycles. An overview.



## THE NEW „E1“ SHOCK ABSORBERS (SELECTION)



Manufacturer	Model
BMW	K 1200R S
Honda	CB 1000 R Neo Sports Cafe
	CB 500 F
	CB 650 R Neo Sports Cafe
	CBR 500 R
Kawasaki	NC 750 S
	NC 750 X
	Ninja 650
Kawasaki	Z 650
	Z 900
	Z 900 RS
KTM	390 DUKE
Suzuki	GSF 1200 Bandit
	GSX-S 1000
	GSX-S 750
	SV 650
Yamaha	MT-07
	MT-09
	MT-09 Tracer





# E1

## E1

<b>Concept</b>	Conventional shock absorbers, without external expansion tanks. Settings for spring preload and rebound.
<b>Riding modes</b>	–
<b>Adjusting the spring preload</b>	Manual
<b>Adjusting the damping</b>	Manual
<b>Sensor system</b>	–
<b>Procedure</b>	The compression and extension movement is damped according to the manually preselected setting. The balance of the vehicle is adjusted via the spring preload.
<b>Available for</b>	numerous models
<b>Remark</b>	E1 is the introduction to the world of Touratech Suspension. Available for hundreds of motorcycle models from more than four decades.



**NOW IN THE WEB SHOP! USE TOURATECH SUSPENSION E1 SHOCK ABSORBERS "OUT OF THE BOX". E1 SHOCK ABSORBERS FEATURE A SPECIAL TOURATECH SUSPENSION SET-UP FOR YOUR MOTORCYCLE. OTHER EQUIPMENT VARIANTS AVAILABLE ON REQUEST. FOR THIS, PLEASE USE THE TOURATECH SUSPENSION CHECK.**



**TOURATECH-SUSPENSION.COM**

**E1**



# TOURATECH SUSPENSION

## Technical info:

- Touratech Suspension shock absorber in gas/oil emulsion design
- Adjustable spring preload
- 50 click adjustable rebound damping
- Stepless progressive spring, white or black coated
- Piston rod made of chrome-molybdenum steel,  $\varnothing$  16 mm
- Damper piston  $\varnothing$  46 mm /  $\varnothing$  36 mm (twin shocks)
- Generously dimensioned damper tube
- Consistent damping even under hard use
- High-quality finish
- With GOP





## WHEN DO I NEED A TOURATECH SUSPENSION SYSTEM?

- 1 Do you travel a lot on your motorcycle?
- 2 Do you want to transform your motorbike into a completely new riding machine?
- 3 Do you often ride with a pillion passenger?
- 4 Do you often carry luggage?
- 5 Are you looking for refined technology with advanced functionality and durability?



**TOURATECH  
SUSPENSION**

**TRAVEL**

## AND HOW DO I BENEFIT FROM A TOURATECH SUSPENSION SYSTEM?

- We transform your motorcycle into the best possible touring bike
- Maximum ride dynamics for total enjoyment
- Unique Touratech suspension setup for your motorbike
- Enhanced ride comfort and more sensitive response than standard suspension
- Touratech Suspension also has suspension components for long-distance and extreme riding
- Touratech Suspension shocks are fully serviceable for a long lifespan



## UNIQUE FEATURES OF TOURATECH SUSPENSION SHOCK ABSORBERS:

- Made for adventure and touring bikes
- Built for hard use and heavy loads
- Supplied with special Touratech setup for each respective motorbike
- Top performance on and offroad
- Highest quality materials for long life
- Uniquely solid Touratech hydraulic spring preload with 50% greater adjustment range
- For weekend trips, riding with a passenger and/or a long tour with lots of luggage
- Precise, high-performance damping even with very high damping frequency (bad roads, dirt tracks)



## FROM EXPLORE TO EXTREME...

Touratech Travel suspension is available in various designs - Level 1, Level 2, High End and Extreme - whereby all our shock absorbers have the following features:

- Special Touratech setup for balance and damping
- Adjustable rebound damping at the bottom of the shock absorber with special setup for touring
- Large 16 mm piston rod made of chrome-molybdenum steel for maximum strength and durability
- Floating piston design: damping fluids, oil and nitrogen are separated, resulting in a more sensitive shock absorber response.
- Low friction special seals with integrated Teflon backup ring for low wear and long shock absorber life
- Robust stainless steel bushings in the shaft eyelet to ensure stable seating of the fastening screw even under maximum loads
- Fully service-enabled, ensuring optimum ride dynamics at all times
- Available with further spring rates to compensate for higher or lower driver's weight and payload

All Touratech suspensions from **Level 2** onwards also feature a uniquely solid hydraulic spring preload with 50% more range of adjustment for weekend trips or large amounts of luggage for your long-distance trip.



LEVEL 1



LEVEL 2

From the third stage onwards, known as the **High End** version, all Touratech Suspension shock absorbers have, in addition, the following features:

- Separately adjustable high and low speed damping, for precise damping setting at very high damping frequency and under heavy use (bad roads, trails carrying luggage)
- Piggyback-reservoir on the shock absorber for improved cooling performance of the shock absorber oil and higher damping performance under heavy use



HIGH END

A further development of the High End version was achieved with the Touratech Extreme suspension. In addition to all the previously mentioned features, the **Extreme shock absorbers** have the following:

- PDS - travel-dependent damper piston: hydraulic bottoming out protection using a second damper piston, i.e. no bottoming out of the shock absorber



EXTREME







## LEVEL 1 | EXPLORE

- Fully serviceable, providing lasting precision and a long service life
- Adjustable rebound damping at the foot of the shock with special traveling set-up
- Available with other spring rates for compensating for a greater or lower rider weight or load
- Strong stainless steel bushings in the spring eye ensure the mounting bolt is seated firmly even under extremely high loads.
- Special low-friction seals with integrated Teflon back-up ring for low wear and a long service life
- Strong chromoly steel piston rod with 16 mm diameter for maximum strength and durability
- Floating piston design. Oil and nitrogen are separate, which provides a more responsive shock absorber.
- Special Touratech set-up of balance and damping

## LEVEL 2 | EXPLORE HP

### as Level 1 PLUS

- Solid hydraulic Touratech preload with 50% larger adjustment range – from a weekend tour to long-distance trip with luggage.

## HIGH END | EXPEDITION

### as Level 1 PLUS

- Solid hydraulic Touratech preload with 50% larger adjustment range – from a weekend tour to long-distance trip with luggage
- Separately adjustable high- and low-speed damping. For precise damping adjustment with very high damping frequency and high load
- Reservoir on the shock providing greater cooling of the damping fluid and improved damping performance under high loads

## EXTREME

### as Level 1 PLUS

- Solid hydraulic Touratech preload with 50% larger adjustment range – from a weekend tour to long-distance trip with luggage
- Separately adjustable high- and low-speed damping. For precise damping adjustment with very high damping frequency and high load
- Reservoir on the shock providing greater cooling of the damping fluid and improved damping performance under high loads
- Suspension length adjustable by a third of an inch (-1/12 inch / +3/12 inch). Depending on the motorcycle model, basic adjustment of motorcycle balance possible. Also adjustment for special modifications or an extreme set-up
- PDS position-sensitive damping system, which utilizes a second damping piston to provide hydraulic protection against bottoming out

To find the suspension for your motorcycle check out our website: [touratech-suspension.com](http://touratech-suspension.com)



# SAME BUTTON – BETTER RIDE



Touratech Suspension Plug & Travel ESA shock absorbers available for:

- BMW R 1200 GS / ADV (2007–2013)
- BMW R 1200 GS / ADV LC (2013–/2014–)
- BMW R 1250 GS / ADV (2018–)
- BMW F 800 GS (2013–)
- BMW F 850 GS (2018–)

Detailed information about the Touratech Suspension Plug & Travel shock absorbers check out our website: [touratech-suspension.com](http://touratech-suspension.com)

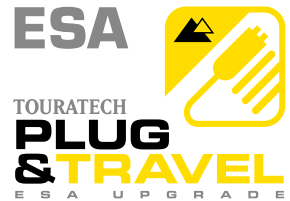

FRONT



REAR

To find the suspension for your motorcycle check out our website: [touratech-suspension.com](http://touratech-suspension.com)





## ELECTRONIC SUSPENSIONS

Touratech Suspension Plug & Travel suspension systems are available in different versions depending on the motorbike - type and model year.

The following features distinguish Touratech Suspension Plug & Travel suspension systems:

- + The suspension is integrated into your bike and operated via the original BMW control unit.
- + Special Touratech basic setup for balance and damping.
- + The existing plug connectors and switches on the handlebars are used as usual.
- + All ride modes and configurations remain the same.
- + Touratech EPA (EPA = Electric-Preload Adjuster) balances your motorbike with a 15 mm preload range +/- via the remote control.
- + Damping adjustment, depending on the model year, via our patented DDA valve or the Touratech Suspension stepper motor
- + Separately adjustable high and low speed damping, depending on the model, for precise damping setting at very high damping frequency and under heavy use
- + Depending on the model, piggyback-reservoir on the shock absorber for improved cooling performance of the shock absorber oil and higher damping performance under heavy use
- + Large 16 mm piston rod made of chrome-molybdenum steel for maximum strength and durability.
- + Low friction special seals with integrated Teflon backup ring for low wear and long shock absorber life
- + Robust stainless steel bushings in the shaft eyelet to ensure stable seating of the fastening screw even under heavy use
- + Fully service-enabled, ensuring optimum ride dynamics at all times
- + Available also as lowering kit
- + Available with further spring rates



The shock absorber for your forks

# CARTRIDGE KIT



Putting it simply, the Touratech Suspension Cartridge Kit Extreme is a suspension strut for the fork and the absolute top end in terms of suspension technology. The Closed Cartridge is installed into the original fork. This way the fork bridge/handlebar mount, brakes and wheel control and handlebar geometry are retained in full. No additional modifications to the fork are required.

This Closed Cartridge is been developed perfectly for touring and riding with frequent and strongly differing loads and riding conditions or extreme requirements.

To find the suspension for your motorcycle check out our website:  
[touratech-suspension.com](http://touratech-suspension.com)



## Scope of delivery:

- 2x Closed Cartridge with damper setting, (1x) rebound stage, (1x) compression stage.
- with spring preloading via adjustment tool (2x)
- adjustment tool
- ready for installation and ready-to-ride, fitted with pre-mounted fork spring. .
- 1 litre oil (for installation of fork)
- user manual and instructions for installation
- 2x Fork protection sticker

The optimum for your motorcycle forks

# FORK SPRINGS



[touratech-suspension.com](http://touratech-suspension.com)



For Touratech Suspension fork springs, we work with Hyperpro – the best possible partner. Our adventure touring fork springs are designed to combine perfectly with our Touratech Suspension shock absorbers.

They give you a sensitive response and high reserves under load and/or during trips with off-road sections.

Each fork spring set is specially adapted and manufactured by Hyperpro according to our specifications for the respective motorcycle model. Touratech Suspension fork springs are „infinitely progressive“ along their full length. Each of our fork spring sets is supplied with the appropriate detailed fitting instructions for the respective motorcycle type. We recommend having the fork springs fitted at a specialist workshop or Touratech Suspension service centre.

For you, this means:

- Optimum damping comfort over the fork's complete spring travel
- Always optimal tyre grip and clean feedback from the road surface
- Damping reserves with heavy loads on bad roads until bottoming-out protection
- Ideal for travelling with a pillion passenger and/or luggage
- Best fork tuning for chasing curves or dusty trails
- All Touratech Suspension fork springs are road legal
- Touratech Suspension fork springs are always supplied with the correct fork oil



# REPLACEMENT SPRINGS



To find the suspension for your motorcycle check out our website:  
[touratech-suspension.com](http://touratech-suspension.com)

## Suspension optimisation with „Touratech setup“ for your standard suspension system.

Are you looking for a cost-effective way to improve the standard suspension system on your new motor-bike? Our adventure touring replacement springs are specially designed to optimise the respective standard suspension system. They give you a sensitive response and high reserves under heavy loads and/or while carrying a pillion passenger.

Here too, we work with Hyperpro – the best possible partner. Each replacement spring set is perfectly adapted and manufactured by Hyperpro for the standard suspension system on the respective motorcycle type. Touratech Suspension replacement springs are „infinitely progressive“ along their full length.

Each of our replacement spring sets is supplied with the appropriate detailed fitting instructions for the respective motorcycle type. We recommend having the replacement springs fitted at a specialist workshop or Touratech Suspension service centre.

For you, this means:

- Optimum damping comfort over the complete spring travel of your standard suspension system
- Always optimal tyre grip and clean feedback from the road surface
- Damping reserves with heavy loads on bad roads until bottoming-out protection
- Ideal for travelling with a pillion passenger and/or luggage
- Best possible standard suspension system tuning for touring use
- All Touratech Suspension replacement springs are road legal
- Touratech Suspension replacement springs are always supplied ready to fit

# LOWERING

with the best possible suspension characteristics, adapted for each respective motorcycle model



## 1

### Replacement springs:

- Depending on the bike, **lowering between 20 mm and 50 mm is possible.**
- The replacement springs are specially adapted for the motorbike.
- „Infinitely progressive“ along the entire length for sensitive.
- Response and damping reserves under high load.
- Optimal tyre grip and clean feedback from the road surface.
- Best possible Touratech setup with high level of riding safety.
- Original side stand and main stand can mostly still be used.
- Extensive fitting instructions specifically for the respective motorcycle type.

## 2

### Fork springs:

- Can only be used in conjunction with a suitably matched shock absorber (see below).
- In addition, shortened versions of the original side and main stand are required from the motorcycle manufacturer.
- Depending on the bike, **lowering between 20 mm and 50 mm is possible.**
- The fork springs are specially adapted for the motorbike.
- „Infinitely progressive“ along the entire length for sensitive response and damping reserves under high load.
- Optimal tyre grip and clean feedback from the road surface.
- Extensive fitting instructions specifically for the respective motorcycle type.

## 3

### Shock absorber:

- The best solution for lowering your motorbike.
- Can only be used in conjunction with a suitably matched fork spring (see above).
- In addition, shortened versions of the original side and main stand are required from the motorcycle manufacturer.
- Depending on the bike, **lowering between -20 mm and -50 mm is possible.**
- The shock absorber is specially adapted for the motorbike.
- Unique adventure touring „Touratech setup“ combining balance and damping.
- Various shock absorber types possible.
- Top performance on and off-road. Optional stronger spring rates.
- Optimal tyre grip and clean feedback from the road surface.
- Extensive fitting instructions specifically for the respective motorcycle type.



**ALL SHOCKS FULLY SERVICEABLE!**



# FULL SERVICE, PLEASE



**1** First off, when the shock arrives in the service center the job is logged and the data checked.



**2** Dismantling the shock. This procedure is not only the first step in taking the shock apart – it is also has to be performed if a shock with a different spring rate needs fitting.



**3** Once the shock has been checked over, the nitrogen is released. Now the housing can be opened. Next, the damping oil is drained and the piston removed.



**4** The innards: Shim stack, piston and gaskets. All the parts are carefully inspected for any signs of wear or damage.



**5** Once the shock has been examined and any necessary maintenance performed, it is then reassembled. The piston will always be given a new sealing strip and, if necessary, a replacement sealing head.



**6** Once it has been filled with new oil, the shock is topped up with nitrogen. Then a final check is performed.





Stabilisation factor

## STEERING DAMPER

The Touratech Suspension CSC steering damper effectively optimises ride stability – whether for off-road and touring use carrying a heavy load or while chasing curves. Trials and experience have shown that the linear Touratech Suspension CSC (Constant Safety Control) steering damper with its permanent assistive effect adds a whole new dimension to riding.

- CNC-milled from high-grade 7075 aircraft aluminium
- Optimal response characteristics for maximum safety
- Stroke, adapted to the particular motorcycle
- Individual damping adjustment through 24 clicks
- Road legal

**Fitting the CSC steering damper makes your bike's ride and handling significantly more stable, less tiring, and safer. Always supplied complete with appropriate mounting kit for the motorcycle type.**

### What the Touratech Suspension CSC steering damper does:

- No more hard steering when cornering slowly with a heavy load
- Minimised disturbances transmitted to the handlebar by the rider
- For example: wind flow over motorcycle clothing and turbulence caused by a truck or van in front
- Minimised instability caused by ruts on motorways, main roads and dirt tracks
- Small front wheel with knobbly tires is noticeably more stable when riding off-road or on sand
- Less fatigue on long journeys thanks to consistently greater ride stability

To find the suspension for your motorcycle check out our website:  
[touratech-suspension.com](http://touratech-suspension.com)





# SUSPENSION WORKSHOP



## ADV

Adventure touring with pillion passenger and luggage:

To keep the bike balanced despite the extra load, the preload on the shock absorber spring has to be increased to restore the ratio between positive and negative spring travel. The damping should be set somewhat harder to stop the bike bouncing around.



1

### Spring preload:

increase slightly at the front (if possible), increase more at the rear

### Rebound:

somewhat harder at the front, somewhat harder at the rear. Careful – not too much, so the shock absorber still develops enough grip

2



3

### Compression:

somewhat harder at the front and rear until comfortable for you (high speed / low speed)

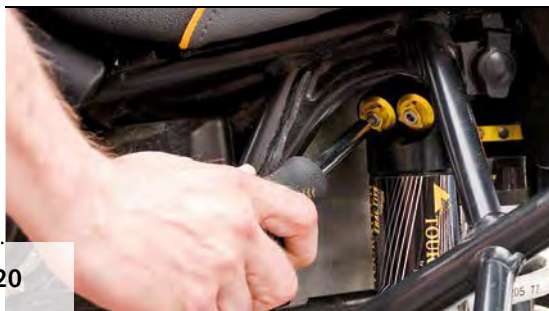

## Tuning the damping:

With the special Touratech setup for a rider's weight including luggage of up to 100 kg, Touratech Suspension shock absorbers are ideally adjusted out-of-the-box for 90% of road surface conditions and uses. The only important thing is to remember to adjust the spring preload (balance/sag) as the load increases. This ensures your headlight isn't pointing at the treetops. Adjusting the damping is a matter of fine-tuning.



1

To adjust the height of the bike, measure the distance between the rear axle and a reference point on the bike.

This distance should be measured with no load on the suspension,...

...under the bike's own weight...

2



3

...and with a typical load, e.g. solo rider, rider with luggage, two people without luggage. For measurements 2 and 3 respectively, 10% and 30% of the total spring travel should be used.





91323 46-12-25-200

**BLACK**



## TWIN SHOCK ABSORBERS FOR URBAN BIKES

With Black-T shock absorbers, Touratech Suspension has created a unique combination of classical design on the one hand and state-of-the-art technological features from the field of suspension technology on the other.

Black-T shock absorbers can be adapted to both your personal driving style as well as your customised bike. High performance and best quality along with perfect setup guarantee maximum ride pleasure. The following features distinguish our Urban suspensions:

- Special Touratech setup for balance and damping
- Large 16 mm piston rod made of chrome-molybdenum steel for maximum strength and durability
- Low friction special seals with integrated Teflon backup ring for low wear and long shock absorber life
- 38 mm Touratech suspension damping pistons
- Robust stainless steel bushings in the shaft eyelet to ensure stable seating of the fastening screw even under heavy use
- Fully service-enabled, ensuring optimum ride dynamics at all times
- Available with further spring rates
- Length adjustment





**TOURATECH**  
SUSPENSION

**URBAN**

The „High-end“ version also has the following features:

- Separately adjustable high and low speed damping
- An additional piggyback-reservoir provides improved cooling of the damping fluids for increased damping performance
- Damping fluids, oil and nitrogen are separated, resulting in a more sensitive shock absorber response.

In addition, all the Black-T shock absorber assemblies and components were designed for „High-end“ use.



HIGH END

**TRIUMPH**

**INDIAN**

**BMW K | R9T | R18**

**HARLEY-DAVIDSON**

To find the suspension for your motorcycle check out our website:  
[touratech-suspension.com](http://touratech-suspension.com)







The shock absorber for your forks

## CLOSED CARTRIDGE KIT

Putting it simply, the Black-T Closed Cartridge Kit is a suspension strut for the fork and the absolute top end in terms of suspension technology. The Closed Cartridge is installed into the original fork. This way the fork bridge/handlebar mount, brakes and wheel control and handlebar geometry are retained in full. No additional modifications to the fork are required.

This Closed Cartridge is been developed perfectly for touring and riding with frequent and strongly differing loads and riding conditions or extreme requirements.



Suspension optimisation with „Touratech setup“  
for your standard suspension system

## REPLACEMENT SPRINGS

- Optimum damping comfort over the complete spring travel of your standard suspension system
- Always optimal tyre grip and clean feedback from the road surface
- Damping reserves with heavy loads on bad roads until bottoming-out protection
- Ideal for travelling with a pillion passenger and/ or luggage
- Best possible standard suspension system tuning for touring use
- All Black-T Suspension replacement springs are road legal
- Black-T Suspension replacement springs are always supplied ready to fit



To find the suspension for  
your motorcycle check out our  
website:  
[touratech-suspension.com](http://touratech-suspension.com)





# TOURATECH SUSPENSION

## SERVICE CENTER NIEDERESCHACH



### Our Services:

- Settings
- Changing springs
- Changing chassis
- Fitting of chassis
- Modification of chassis
- Lowering
- Tuning
- Changing fork springs
- Fitting cartridge
- Fitting steering dampers
- Complete Inspection Service for your rear shock / suspension
- Service & revision of Suspension Systems from many well-known manufacturers.



Get advice from our experts:

+49 (0) 77 28 92 79 15 55

# TOURATECH SUSPENSION SERVICE CENTER

## WORLDWIDE

professional equipment | many years of know-how | expert team on site



- Touratech Headquarters Germany
- WM Bikes Germany
- Touratech Czech Republic
- Novatec Spain
- Touratech Turkey
- Touratech Thailand
- Touratech Peru
- Touratech USA

Our support bases and the respective country representatives can be found from page 4 together with all the contact data.

TOURATECH-SUSPENSION.COM



Which suspension is right for me and my bike?

# SUSPENSION CHECK

Let us know your personal requirements, using our suspension check, and our team of consultants will help you find the right suspension for your bike and your individual purpose. Alternatively, we are also happy to advise you at one of our Sales & Service centres.



To find the suspension for your motorcycle check out our website: [touratech-suspension.com](http://touratech-suspension.com)



TOURATECH SUSPENSION

How and where is your motorbike primarily used?

Off-road - trails

Long trips with high proportion off-road riding and tracks, with full luggage\*

never

rarely

often

always

Off-road - trails with pillion passenger

Long trips with high proportion off-road riding and tracks, with full luggage\*

never

rarely

often

always

Off-road - enduro trails

Enduro trails, difficult terrain, only journey to the trail on asphalt, at the most

never

rarely

often

always

Off-road - rallies and sport

The motorbike will not be ridden in road traffic. A specially adjusted suspension setup will be required\*

never

rarely

often

always



Handlebar | windscreen | fuel solutions

p. 630



Electrics | power

p. 632





# EQUIPMENT

UNIVERSALTEILE

EQUIPAMIENTO

EQUIPEMENT

ÉQUIPEMENT

Oil | care products

p. 635



Tools | repair kits

p. 642



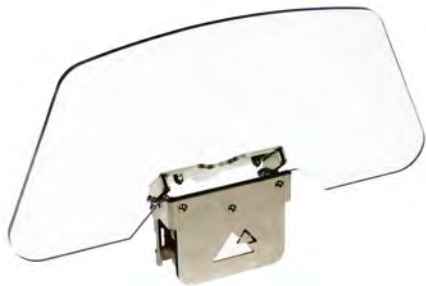

### Universal windscreen spoiler

As requested by many customers, there is finally a windscreen spoiler that fits almost all common windscreens. Simply and easy to fit. Increases windscreen height by about 13 cm and is adjustable to different angles. Forget about nasty airflow and noise.

040-1392 lockable



### Rear-view mirror Adventure folding

Robust folding rear-view mirror for all motorcycles with a right-handed thread

- can be set to eleven predefined positions
- can be used left or right
- with ECE certificate
- patented design

040-0770 M10x1,5 for BMW

040-0771 M10x1,25 for example KTM, Honda, Ducati



### Folding mirror, length adjustable

Universal folding mirror, length and angle continuously adjustable, to suit most motorbikes.

- suitable for use on left or right
- carries the E test mark

040-0760

Mounting adapter M10 x 1,5  
for the BMW F 800/650 (Twin) GS, HP2 and R 1200 GS/ADV

040-0761



### Adapter for rear-view mirror

for right-handed M10 x 1,25 to M8 x 1,25 thread

040-0772

### Rear view mirror adapter set for Yamaha

For mounting all replacement mirrors (M10x1,25) with right-hand thread to left-hand thread

040-0778

## Safety rear-view mirror set, aspherical, right-hand thread

The Safety rear-view mirror is the ideal motorcycle mirror for your Adventure Bike. Thanks to the aspherical part, the visible area is increased - making the "dead angle" a thing of the past. A set for both the left and the right side.

040-0780 M10 x 1,5 (BMW)

040-0785 M10 x 1,25 (KTM, Honda, Ducati)



## Crossbar

For some time now, many enduro bikes have not been equipped with a crossbar. Many streetfighters with high handlebars don't have one, although it is ideal for mounting some interesting accessories: - Roadbook holders - GPS receivers - Motorcycle computers - Map holders - and many more.

To fit all these accessories you will need to mount our crossbar.

040-0603 22/25 290 mm

040-0604 22/25 250 mm



## Emergency fuel bag, Touratech Jollytank, disposable folding canister 8 l

- Capacity: 8 litres
- Weight: approx. 50 gr (empty)
- With carrying handle
- Disposable container, can be recycled

100-0032

## Dual USB Plug-n-Play socket

### for BMW Motorcycles

Let's be honest: Do you really use the DIN socket on your BMW? Simply replace it with the much more useful double USB socket! Charge your smartphone, camera, GPS, etc. without adapter while driving!

- Input voltage: 10 to 40 V
- Output voltage (USB ports): 5 V +/- 5%
- Output overvoltage, overheating and short-circuit protection
- Fully CanBus compatible
- Total 3.3 Amp output, with current limiters per port (master port 1: 2.3 A / Aux port 2: 1.0 A)
- Intelligent device recognition: detects if Apple (meets MFi standard) or Android (BC1.2).
- Weatherproof: independent port rubber covers
- Plug compatible with BMW motorcycle DIN socket installation



030-0084

## Dual USB socket for handlebar clamp mount

Output power connection 1: 2.3 A / connection 2: 1.0 A  
It is supplied with:

- Dual USB charger with nut
- Power cable fused
- Mounting bracket
- Set of M8 screws, washers, spacers and covers

Note: not compatible with older air cooled R1200GS handlebars (K25)

030-0089





## Diagnostic tool Duonix Bikescan-100 „Touratech Edition“ for motorbikes with OBD2 diagnostic connector

Exclusively at Touratech, the Duonix Bikescan-100 with OBD2 diagnostic connector is available for almost every modern motorbike.

The Bikescan-100 is small and powerful and therefore ideal for professional control unit diagnostics on motorbikes. This system covers the entire motorbike electronics and makes troubleshooting much easier for the user. The many special functions and settings can be carried out directly on the device without connecting the system to a computer or laptop. Ideal for travelling.

### Special functions:

- Service reset date / path
- Date and time setting e.g. following a battery replacement
- Reset of adaptation values
- Specific actual values
- Reading current km
- Reading VIN
- Valve clearance service reset
- Calibration of the fill level indicator sensor in the tank (e.g.: foil sensor 1200GS)

- Idle actuator calibration
- Brake wear indicator initialisation
- Windshield calibration
- ESA calibration
- Stepper adjustment
- Exhaust flap adjustment
- Gear adaptation adjustment
- Free updates
- Actuator diagnosis
- Tire pressure sensor teaching / programming
- No limitation or restriction on models



Supported protocols:

- KWP-2000 specific
- CAN BUS specific
- UDS specific

**For all motorbikes with OBD2 diagnostic connector**

**Supported controllers:**

- Engine electronics from Motronic 2.4
- Central electronics
- Instrument cluster
- Tire pressure control
- ABS Antilock Braking System from I-ABS
- Anti-theft alarm
- Radio
- Radio control unit
- Electric Hydraulic stand

**Scope of delivery:**

Device, case, OBD2 diagnostic cable, USB cable and manual.

**030-0104**

**030-0105 for motorcycles 10-pin diagnostic connector**

## Powerbank and jump start for motorbikes, Absaar 18.000mAh

Power supply and starting aid always with you - the ideal companion for every motorbike adventure!

Very compact jump starter with super powerful 18000mAh capacity. This mobile energy station consistently starts all vehicles of any size with 12V batteries, whether petrol or diesel vehicles.

The rubberised surface and the practical plastic case make the jump starter an absolute professional accessory. The size and weight are a highlight. The 600A in start and 1000A in peak are compensated on 176x99x48mm and only 0,52kg. Jump start pack with emergency jump start function for your vehicle as well as power bank function for charging electronic devices via 4 in 1 USB charging cable.

In addition, laptops can be powered with the adapters and charging cable. A torch is also built in, which lights the right way for 38 hours in continuous light mode.

Outgoing voltage at the car starter: 12V,  
2x USB output: 5V/1A, 5V/2A, output 12/19V

Starting current: 600A

Maximum current: 1000A

Life cycle: 1000 times

Possible temperatures: -25 to +60 degrees

Packaging: plastic case

Protected functions: Overcharge, deep discharge

With lamp & SOS function, Charging time: 3h

The following accessories are included:

Smart battery clips, power supply unit, car power supply unit, 4 in 1 charging cable, notebook charging cable and adapter, plastic case.

Single jump starter: 0.52kg

Dimensions: 176x99x48mm

**065-0755**





## Charger „Compact Worldwide“

Suitable for BMW CAN bus

- Maintenance charging function and charge state LED
- 5 m cable and Onboard power supply plug with 4 interchangeable plugs for EU, UK, USA and AUS
- IN: 100-240 V; 50-60 Hz; 550 mA & OUT: 12 V; 1.66A
- Suitable for lead, lead gel and maintenance free batteries

130-0014



### Right angle USB charger

for DIN motorcycle socket

030-0165



### DIN socket

with handlebar mounting

030-0171



### Adapter grippers

for cigarette lighter socket

030-0168

### Auxiliaries socket

with handlebar mounting, 22-28 mm

030-0167



### 2pol superseal connector - set incl. dummy plug

waterproof up to IP 67  
max. 14A  
max. 24V DC

1x AMP Superseal socket housing 2-pol  
1x AMP Superseal pin housing 2-pol  
1x AMP Superseal dummy plug 2-pol  
3x AMP Superseal socket contact 0,75-1,5 mm<sup>2</sup>  
3x AMP Superseal pin contact 0,75-1,5 mm<sup>2</sup>  
4x AMP Superseal seal yellow for 1,8-2,4 mm  
4x AMP Superseal seal green for 1,4-1,7 mm

015-0090



### Dual USB socket for motorbikes

12-24 V, for 22 mm handlebar

030-0065 USB-Adapter ZA



### Dual USB socket for motorbikes

12 - 24 V, for 22 mm handlebar

030-0029 USB-Adapter





**USB tank bag cable**  
with right angle DIN connector

030-0157

**Remote control switch**

1 x universal 4A/30V

030-0170



**Power cable BMW CAN BUS**

for BMW motorbikes

065-0293



**LED Lightbar Aux light 8° SPOT**

Special features:

- Certification as driving light and electromagnetic compatibility
- Homologation ECE R112 and R10
- Range: 377m (0.25Lx)
- Reference number: 12.5
- shockproof and waterproof
- UV-shielded
- anodized polyester-powder coating
- efficient polycarbonate-lensreflector

Technical Data:

- Input Voltage: 9-36 V
- Light Source: 6x

- OSRAM LED Chips
- Power input: 14 W
- Raw lumens: 920 lm
- Light spread: ECE driving pattern Spot 8°
- Light intensity: 35.600 cd
- Protection class: IP68
- Lens: break-resistant polycarbonate
- Housing: die-cast Aluminium
- Mounting: standing|hanging
- Connection: DT-plug
- Weight: 324 gr.
- Dimension: 182.0 x 63.5 x 38.0 mm
- Hole distance: 113.0 mm

040-2022



**LED Lightbar Aux light 30° FLOOD**

Special features:

- Certification as driving light and electromagnetic compatibility
- Homologation ECE R112 and R10
- Range: 300 m (1.0 Lx)
- Reference number: 20
- shockproof and waterproof
- UV-shielded

Technical Data:

- Input Voltage: 12-24 V
- Light Source: 4x OSRAM LED Chips
- Power input: 31 W
- Raw lumens: 3360 lm
- Light spread: ECE driving pattern
- Light intensity: 83.600 cd
- Protection class: IP69K
- Lens: break-resistant polycarbonate
- Housing: die-cast Aluminium
- Connection: DT-plug
- Weight: 700 gr.
- Dimension: 224 x 67.2 x 38.5 mm

040-2023



## 4-Stroke Motor Oils

**Motorex oil - Power Synt 4T SAE 10W/50 - JASO MA2**

KTM recommends this oil for all its 4-stroke engines.

- Specifications: JASO MA2; API SM; API SL; API SJ; API SH; API SG
- Fully synthetic oil
- Optimal wear protection for engine, transmission and clutch
- Extreme temperature and shear stability
- Ideal for oil bath clutches (JASO MA2 release)
- catalyst Tested
- Racing Quality

400-0227 1 litre

400-0228 4 litres

**CROSS POWER 4T**

- Fully synthetic
- Off-road racing quality
- Viscosity and specifications: SAE 10W/50: JASO MA – API SL, SJ, SH, SG SAE 10W/60: JASO MA – API SJ, SH, SG; KTM LC4 2007+

400-0174 (10W/50 - 1 litre)

400-0176 (10W/60 - 1 litre)

**TOP SPEED 4T**

- Synthetic performance
- For on-road and off-road use
- Viscosity and specifications: SAE 10W/30, 10W/40, 15W/50: JASO MA – API SL, SJ, SH, SG

400-0168 (10W/30 - 1 litre)

400-0170 (10W/40 - 1 litre)

**BOXER 4T 15W/50**

- Synthetic performance
- Reduces oil consumption
- Viscosity and specifications: SAE 15W/50: JASO MA – API SL, SJ, SH, SG

400-0166 (1 litre)





## Transmission Oils

### GEAR OIL PRISMA ZX

for shaft drive and gearboxes

- Synthetic gear oil
- Excellent gear-changing performance
- Specifically for motorcycles with separately lubricated gearboxes shaft drives, hypoid gears)
- Viscosity and specifications: SAE 75W/90; API GL 4+5

400-0180 (1 litre)



## Brake Fluid – Coolant

### BRAKE FLUID DOT 5.1

- Brake fluid with high wet boiling point (180 °C)
- Better performance at cold temperatures
- More sensitive response
- Specifications: FMVSS 116 DOT3/4/5.1

400-0192 (250 g)



## COOLANT M5.0 Ready To Use

Special coolant that meets the requirements of various manufacturers of modern, high-performance engines.

- Ready to use
- Antifreeze protection down to -38 °C
- Inhibits rust and corrosion
- Free of nitrites, phosphates and amines
- Specifications: SAE J 1034 – ASTM 3306, 4656, BS 6580

400-0210 (1 litre)



## Additives



### SYSTEM GUARD

Cleans and dissolves deposits throughout the entire injection system.

- For two-stroke and four-stroke petrol engines with and without a catalytic converter
- Improves corrosion protection, binds water



400-0194 (125 ml)



## FUEL STABILIZER

Indispensable when laying up your motorbike for winter.

Stabilises lead-free fuel and keeps it ignitable.

- For two-stroke and four-stroke petrol engines with and without a catalytic converter
- Prevents oxidation and the associated gumming and deposits



400-0193 (125 ml)

## Specialities

### BOXER 4T 5W/40 JASO MA2

- Synthetic performance
- Reduces oil consumption
- Viscosity and specifications: SAE 5W/40; JASO MA2 – API SN, SL, SJ

400-0218 (1 litre)



### KTM RACING 4T

- Fully synthetic
- Recommended by KTM Customer Racing
- Viscosity and specifications: SAE 20W/60; KTM RACE ENGINE, MX, SM, RALLY, ENDURO

400-0178 (1 litre)



## 2-Stroke Motor Oils

### CROSS POWER 2T

- Fully synthetic
- Racing quality
- Reduces combustion residues
- For premix and separate lubrication

400-0159 (1 litre)



## Fork Oils

### RACING FORK OIL SAE 2.5W - 15W

- Prevents jerky motion (stick-slip)
- Fast fork response
- Care additive for seals
- Optimum damping at all temperatures
- Minimises foaming
- Inhibits corrosion and condensation
- Tested under the most extreme racing conditions

400-0182 (5,0W)

400-0183 (7,5W)

400-0184 (10W)

400-0185 (15W)

1 litre sizes





## Clean and Care

### MOTO CLEAN

Removes stubborn dirt such as insects and brake dust.

- Penetrates well
- Does not attack rubber, paint, chrome or plastic parts
- 360° spray mechanism even works upside down
- Completely biodegradable

Contents: 1 litre spray

400-0199



### QUICK CLEANER

Quickly clean your motorbike without adding water – perfect for travelling!

- Water-repellent beading effect
- Anti-static
- For plastics, glass, paint, metals and windscreens

400-0220 (500 ml)



### MOTO SHINE

Special gloss spray for a perfect finish after car cleaning. For lasting shine on paint, plastic, chrome etc. and creates a protective antistatic film with drop-repellent effect.

- Perfect finish
- Drop-repellent effect
- Can be used on paint, plastic, chrome etc.
- Protective antistatic film

400-0222 (500 ml)



### MOTO PROTECT

Protective spray for the whole motorbike. Ideal protection for long periods of non-use. Maintains and protects with a fine oil film for excellent corrosion protection. Do not apply to brake discs!

400-0223 (500 ml)



### HELMET CARE

Cleaning and care foam for helmet interior padding and shells.

- Cleans and cares for shell, giving a perfect, polished shine
- Also cleans and deodorizes inner padding
- With anti-mist additive

400-0209 (200 ml)

## Air Filter Maintenance

### AIRFILTER CLEANING KIT

Contains all the essential equipment for professional air filter cleaning and care.

- Large bucket for cleaning
- Small bucket for oiling
- 4 l air filter cleaner
- 1 l air filter oil 206
- 100 g grease 2000 for sealing the filter element in the airbox
- Metal grid for draining
- Latex gloves
- 2 Motorex stickers
- Detailed instructions for professional air filter cleaning



400-0186 (Airfilter Cleaning Kit)

400-0187 (1 l Airfilter Cleaner)

400-0189 (1 l Airfilter Oil)



### AIR FILTER OIL SPRAY

Specially developed air filter oil spray for foam air filter elements. Keeps out sand, dust and water. Guaranteed optimal airflow. Very good adhesion.

Container size: 750 ml

400-0158



### BIO LIQUID POWER

MOTOREX RACING BIO LIQUID POWER is an air filter oil that has been specially developed for off-road motorcycles and quads (ATV) equipped with reusable foam air filters. This special, biodegradable oil can absorb very large amounts of dust and dirt. Its active ingredients ensure that any penetration of hazardous materials into the engine is prevented, even under the toughest operating conditions.

Container size: 1 litre

400-0190



### DIRT BIO REMOVER

- Cleaner for foam air filters
- biologically degradable
- water-soluble powder
- developed in co-operation with Twin Air
- quickly dissolves even the most stubborn marks and dirt

Volume: 800g

400-0191





## PROTEX

Effective and easy-to-apply textile and leather waterproofing.

- Highly effective, long-lasting protection against water and oil
- Suitable for leather, textiles and microfibres (e.g. Gore-Tex)
- Allows materials to breathe naturally
- Versatile: ideal for shoes, ski and bicycle wear, convertible tops, tents etc.

400-0208 (500 ml)



## Polyvalent Spray

### JOKER 440

- Universal spray
- Expels water
- Protects against corrosion
- Dielectric effect
- Cleans and cares for metals and plastics

400-0211 (500 ml)



## HKS chain lubricant

### How the HKS chain lubricant works

- At first it's thinner than water, creates a suction effect and gets into the smallest hollow spaces
- Creates a lasting, thick and absolutely waterproof lubricating film similar to a plastic coating
- Lubricating film thickness is between 2 to 5 times thicker than normal
- Has a sealing effect (1); prevents foreign bodies from getting into the chain, reduces wear
- Long-term lubricating effect, will always stick
- Motorbike is ready for use after 3 to 5 minutes
- Chain does not need to be cleaned before re-lubrication
- Does not damage X or O rings

400-0207 HKS extreme (including applicator) 500 ml



## Scottoiler xSystem 2.0 Electronic Chain Oiler

The Scottoiler xSystem is the easiest to install and most user friendly chain oiler yet. The revolutionary design makes the xSystem super compact whilst providing optimal chain lubrication. The new Scottoiler xSystem is perfect for your modern commuter or tourer, looking for a discreet solution to chain maintenance.

- Motion activated electronic chain oiler system
- Simple connection direct to the battery
- Easy installation on all motorbikes
- Easily adjusted flowrate on the reservoir

030-0186



## Chain Care

### CHAINLUBE ADVENTURE

Ideal for combined use on the road and off road with modern adventure bikes.

- White chain lubricant
- Excellent anti-wear protection
- Extremely water-repellent, resistant to spin and temperature stable
- Developed and tested with our ADVENTURE teams

400-0226 (500 ml)



### CHAINLUBE ROAD STRONG

Fling-resistant lubricant for drive chains on road-going motorcycles.

- White chain lubricant
- Excellent anti-wear protection
- The perfect companion for motorbikes up to 180 km/h
- Water-repellent / inhibits corrosion

The chain spray is also available in a refillable mini can for trips.

400-0196 (500 ml)

400-0212 (56 ml refillable mini pack (ready filled))



### CHAIN CLEAN DEGREASER

Extremely effective chain degreaser for all types of motorcycles.

- Does not attack the seals
- Ideal for use before applying MOTOREX chain lube

400-0198 (500 ml)



### CHAINLUBE RACING

High-performance TEFLON® lubricant for motorcycle drive chains, ideal for racing use.

- White chain lubricant
- Excellent anti-wear protection
- Extremely water-repellent, resistant to spin and temperature stable
- Developed and tested for road use with our racing teams

400-0197 (500 ml)



### CHAINLUBE OFF ROAD

Dirt and water-repellent chain lubricant, specially developed for off-road use.

- Colourless
- Water and dirt-repellent
- Reduces wear and extends the life of the chain

400-0195 (500 ml)





## Touratech tarpaulin cover

for long-distance Enduros with cases

The envelope is big enough for you to leave the side cases in situ. Even your topcase can remain on your bike - the cover has a zip fastener that enables you to enlarge it over this area.

601-0020 Outdoor

601-0009 Indoor „Super Soft“



## Tankpad „Touratech“

The practical Tankpad protects the tank from scratches.

Length: 16.5 cm

Width: 9 cm maximum, 5 cm minimum

600-0043 black

ca. 20 cm x 10 cm

600-0081 ADV



600-0081



600-0043

## Paint protection foil 3M universal

300 x 200 mm, transparent

101-0100



101-0100



## Tyre lever

Manufactured from chrome-vanadium, ideal for use on motorcycles.

Pack includes: 1 piece / 250 x 18 mm

070-0285



## Manufacturer specific tool kits by CruzTools

For modern motorcycles special tools are needed. This applies to Japanese motorcycles as well as to European motorcycles.

We've exceeded these needs with this tool kit, which packs top grade tools and other roadside items into a sturdy roll-up pouch.

070-2103 BMW

070-2104 Japanese and European motorcycles

070-2105 KTM



### Heat shield muffler, stainless steel

Avoid the meltdown - prevent bags and side panels from touching your bike's exhaust! The heat shield by Touratech is the simple, lightweight, universal heat problem-solver for virtually any motorcycle exhaust system.

- Rugged stainless steel construction
- Easy to install
- Fits virtually any motorcycle make/model
- Dimensions: 15 x 7 cm
- Stainless steel hose clamp up to 65 cm

080-5055

### 3/8" Dr. Digital Torque Adapter with 1/4" Socket, 4 - 203Nm

Convert any ratchet or breaker bar into a torque measuring tool and/or calibrate your torque wrench!

- Range: 4-203 Nm / 3,68-150 ft-lbs
- Tolerance:  $\pm 2\%$
- Size: 3/8" Dr. & 1/4" adapter (3/8"F x 1/4"M)
- Units of measure: Kg-CM, Kg-M, In.-lb.,

Ft.-lb, N-m

- 10 memory settings
- LED screen light
- Works clockwise and counterclockwise
- Screen can turn 240° to facilitate the reading
- Screen can be reverse
- Accoustic signal

070-2115



070-2210

070-2211

### Touratech motorcycle toolset

Professional motorcycle tool for when you are on the road or in your workshop at home, suitable for 80% of all adjustments and repairs to your motorcycle! Whether you are off on a big motorcycle trip or a small motorcycle tour, with this 60 piece on-board motorcycle toolset you can carry out necessary work at any time. Weighing only 1.03 kg, this robust double layer roll-up bag offers a compact motorcycle toolset made of the best materials: S2 bits with black phosphate rust protection. Sockets and spanners are Cr-V satin chrome-plated. With its compact dimensions, there is always a place somewhere on your bike for this motorcycle toolbag in Touratech design.

MIT socket system (metric, inch, Torx): suitable for square, 6 or 12 point star, spline and damaged nuts.

070-2210 Basic set, 60 pcs

070-2211 BMW, 70 pcs

070-2212 KTM, 68 pcs

070-2213 Honda, Suzuki, Yamaha, Triumph, 70 pcs

### Extension for tool set for BMW motorbikes, for BMW F 850 GS / F 750 GS

Power up your BMW Motorcycle Toolset with this 3-piece Add-On Set for the latest models – BMW F 850 GS and F 750 GS Series. This is a specific add-on for the BMW F 850 GS & F 750 GS Series that complements BMW Motorcycle Tool Set.

#### What's included:

- 3/8" Dr. Impact Stubby Hex Bit Socket 12mm
- 1/2" Dr. 6-Point Socket 34mm
- 3/8" (F) x 1/2" (M) Low Profile Adaptor

070-2116



070-2116



## Tyre pressure gauge with drain valve

- Very rugged aluminium housing
- Utmost precision
- BAR / PSI scale
- Reads up to 4 bar
- straight and 90° angled connector
- Drain valve
- Measures without pressure drop

070-6007



## Puncture repair kit „Stop&Go - Pocket Tire Plugger“

This revolutionary new device easily installs mushroom shaped rubber plugs into all tubeless tires while staying on the wheel. This technology insures maximum reliability while reducing your downtime in any situation. For tubeless tires only!  
Product Contents: Tire Plugging Device, Nozzle, Probe Tool, Reamer/Rasp Tool, Hex Wrench, (15) Mushroom Plugs (5/16" diameter shaft x 3/4" length stem), Retractable Razor Knife, Extra Zip Lock Bag, Laminated Instructions, Vinyl Zippered Pouch (19 x 9 x 2,5 cm)

070-6003



## Slime tyre sealant, 237 ml

For makeshift repair of tubeless and tube type tyres.

070-6010



## Screw-in spikes 1200, pack of 100, incl. screw-in adapter

A must for winter rides and adventures on ice and snow. The spikes are screwed into the tyres using the screw-in adapter (included).

Depth of screw insertion: 10,5 mm, Tip size: 2,3 mm

For use on knobby tyres with a minimum profile height of 10,5 mm.

655-0005



### Compressor AirMan Tour

You can use the AirMan Tour to inflate motorcycle and bicycle tyres.

In addition to its handy portable and lightweight design, its high performance air compressor enables rapid inflation of tires.

070-6005

### AirMan 300 ml Universal Tyre Sealant

070-6008

### AirMan ResQ Scout VT Tyre Repair Kit

The ResQ Scout Tyre Repair Kit is designed for motorcycles and ATV's where space and weight are important factors. Weighing in at only 584g, the system easily fits into a bag or under-seat compartment for ultimate convenience and simplicity. With the bottle in place, the complete kit measures only 100mm x 75mm x 100mm.

Scope of delivery:

- Connections for the power supply 12 V
- 4 clamps
- Compressor
- 100 ml tyre sealant

070-6015

070-6016 100 ml Universal Tyre Sealant



### Accessory bracket for 25 mm tube

With the Touratech accessory bracket you can individually mount your highway pegs, auxiliary headlights or a lightbar on your Touratech crash bar or any other 25 mm tube.

The bracket for M8 nuts and cylinder head bolts make mounting your equipment a breeze. Your crash bar turns into an additional, individual mounting option in no time - without drilling, filing, sawing.

**Designed specifically for tubes with electropolished surface.** Please note that the item may cause damage to the surface of powder-coated pipes!

040-2019

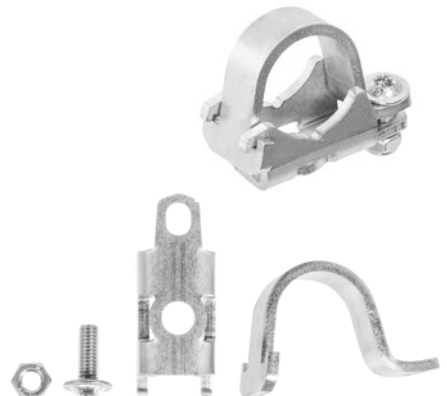



Helmets

p. 648



Suits

p. 670



Functional Underwear

p. 709



# EQUIPMENT

FAHRER-  
AUSSTATTUNG

ÉQUIPEMENT

ABBIGLIAMENTO

EQUIPAMIENTO



Gloves

p. 720



Boots

p. 732



Other

p. 741





 **TOURATECH**  
**AVENTURO**

**HELMETS**









# TOURATECH AVENTURO TRAVELLER



## QUIETER + LIGHTER!

### Touratech Helmet Aventuro Traveller

The Aventuro Traveller is an innovative modular helmet designed specifically for the demands of adventure riding. You'll love that it's lightweight, features huge airflow, and is quiet even at speed. It's a true modular which allows you to open the chin bar for easy communication at the gas station or hatching a plan with your riding buddies.

When the ride gets rowdy or the weather warm, you will love the massive airflow that distributes air around your head to keep you cool and comfortable. A helmet's job is to keep you protected, but a side effect of this protection

is often excessive heat for the rider. The Aventuro Traveller solves this problem with a peak design that passes airflow into the oversized vent on your forehead distributing cooling air around your head for comfort in demanding terrain or hot weather. In fact, the flow is so great that the helmet comes with a 'low-flow' flap that you can close to reduce airflow for riding in cooler weather.

Further airflow cools the rider's face by entering through the large chin vent. The glove-friendly vents are easy to open and close while riding.

# MADE FOR ADVENTURE.

An innovative double seal keeps rain and dust out while reducing sound levels for a comfortable ride. The double seal is crafted from soft rubber, which lines the shield closure surface as well as the chin-bar closure area. This gives you better protection from the elements and also reduces wind noise for a more peaceful and enjoyable ride.



The Aventuro Traveller is lighter than its predecessor and most other modular helmets on the market. The carbon version is a half-pound lighter than the previous model and the multifiber version is a third-of-a-pound lighter. You'll notice reduced neck strain and improved comfort for long days in the saddle.

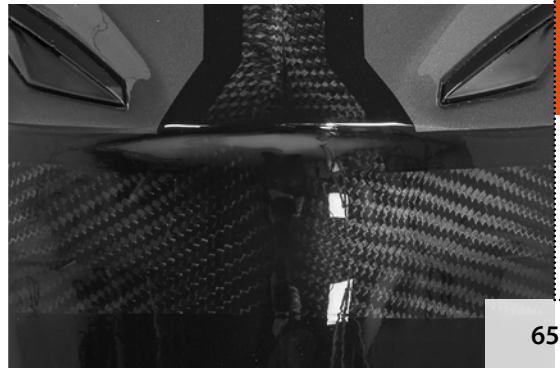



Color  
Core

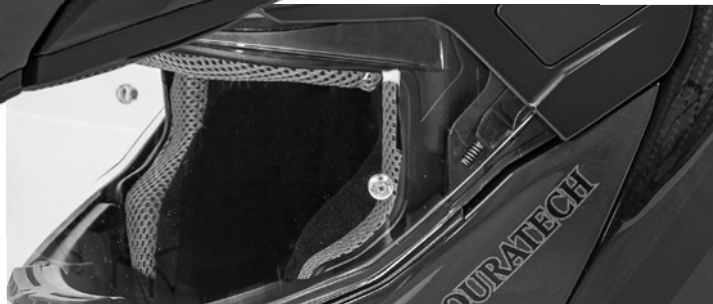

**TOURATECH**  
**AVENTURO**  
**TRAVELLER**



+ You'll enjoy big vistas with the large range of peripheral vision courtesy of the wide opening. The field of view is excellent, providing more information, whether you are riding in the city or enjoying the wide-open road. An integrated sun visor flips down with a glove friendly control providing you with sun protection when needed.

The visor stays open in 4 positions with strong detents. The lowest opening is designated as the anti-fog mode. Additional anti-fog capabilities come courtesy of the Pinlock insert that can be installed for riding in wet situations. Grip tabs located on both sides of the shield allow easy opening with either hand.



+ A gravity-defying chin bar stays in the up position until you pull down to close it. No surprise closings at inopportune moments like some other modular helmets. Designed with easy access to the opening mechanism allowing routine cleaning and maintenance for smooth and consistent operation.

+ Quick-Ratchet buckle with stainless steel mechanism resists corrosion providing quick closure of the chin strap and reliable performance for years.



Stay dry with a cool-max liner that wicks moisture away and provides a soft feel for rider comfort. The neck roll and cheek pads are in one integrated piece for easy removal and cleaning.





The helmet is set up to accommodate most clamp-on style communication systems including SENA, Scala Rider and more. It comes with cavities for speakers and a microphone and easy routing paths for wires making communication installation a snap.

The 'no-grab' peak design cuts through the wind nicely minimizing neck strain keeping you comfortable and it comes with an optional extension to block more sun if desired.

The helmet comes with a removable camera mount on top of the helmet so you can share your adventure with friends. The Aventuro Traveller is available in 3 graphics styles for the carbon fiber version and 2 solid colors for the multifiber version.

Meets the safety standards of a full-face helmet while providing the convenience of a modular.

- Complies with ECE 2205 and DOT
- P/J tested as integral and jet helmet

### Visor for Touratech Aventuro Traveller

500-9200	clear
500-9228	smoke 80%
500-9230	smoke 60%

With preparation for interior anti-fog  
Anti-fog screen not included.

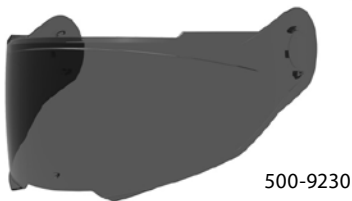
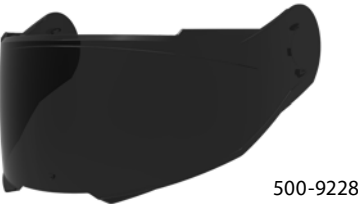
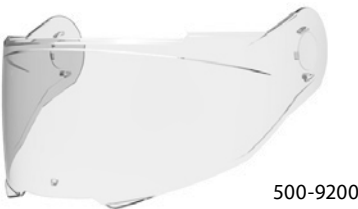

### Sun visor

500-9201	smoke 80%
----------	-----------



### Pinlock™ inner visor

500-9208	clear
----------	-------



### Conversion kit for Touratech Aventuro Traveller visor

500-9229	transparent, incl. screws
----------	---------------------------



With the Touratech Aventuro Traveller you have the ideal companion for your travels.

But what to do on a small city tour? No need for your helmet shield?

No problem! With the new conversion kit you can ride your favorite helmet without shield.

Easy mounting! No tools needed.

## Touratech Aventuro Traveller

FIBREGLASS | ECE 22.05 / DOT

500-2700	white	size XS
500-2701	white	size S
500-2702	white	size M
500-2703	white	size L
500-2704	white	size XL
500-2705	white	size XXL
500-2706	white	size 3XL
500-2710	black	size XS
500-2711	black	size S
500-2712	black	size M
500-2713	black	size L
500-2714	black	size XL
500-2715	black	size XXL
500-2716	black	size 3XL



White



Black

## Touratech Aventuro Traveller

CARBON | ECE 22.05 / DOT

500-2720	Core	size XS
500-2721	Core	size S
500-2722	Core	size M
500-2723	Core	size L
500-2724	Core	size XL
500-2725	Core	size XXL
500-2726	Core	size 3XL
500-2750	Sunrise	size XS
500-2751	Sunrise	size S
500-2752	Sunrise	size M
500-2753	Sunrise	size L
500-2754	Sunrise	size XL
500-2755	Sunrise	size XXL
500-2756	Sunrise	size 3XL
500-2760	Sport	size XS
500-2761	Sport	size S
500-2762	Sport	size M
500-2763	Sport	size L
500-2764	Sport	size XL
500-2765	Sport	size XXL
500-2766	Sport	size 3XL



Core (Carbon)



Sunrise (Carbon)



Sport (Carbon)







# ADVENTURO CARBON 2



# AVENTURO CARBON 2

- New bigger shell in three sizes: XS-S, M-L, XL-3XL
- New size 3XL
- New design for better use with gloves

## New features of the Aventuro Carbon2 at a glance

- New peak for better air flow
- Peak with adjust
- New designed top ventilation

- New design of the visor button
- New Chin Interior (EPS + Plastic Part)
- New Chin curtain (new attachment)
- New strap with more thickness
- New Front Chin Vent



TRAVEL MODE

## Helmet Touratech Aventuro Carbon2

We made the probably most versatile multi-functional helmet even better!

Thanks to our extensive experience with the Aventuro Carbon helmet we were able to improve many details, to take an innovative approach and eventually to create a helmet that speaks for itself.

The entirely newly designed chin part and the new forehead ventilation are not only decora-

tive design elements. They both provide better ventilation and are easy to handle – even with gloves. An ultimate luxury and a guarantee for stress-free riding in every situation.

Due to a new, third shell size an even more precise fitting is possible as we're now able to offer the size 3XL. This helmet fits every head!

There's something for everybody's taste:

The new Aventuro Carbon2 is available in four exciting colours.

## VARIABLE

- Airy when off-road
- Adaptable in mixed use
- Aerodynamic on the road

## SAFE

- Ultra hard carbon shell
- Complies with ECE 2205 and DOT
- Wide field of vision
- Double D-ring closure
- Pin-lock visor

## COMFORTABLE

- Lightweight
- Ergo Padding System
- Easy to use
- Convert without tools
- Clever ventilation
- Skin-friendly washable interior
- Antiperspirant, anti-allergic Coolmax lining

## CLEVER

- Integrated goggle strap guide
- Intercom preparation
- Camera holder
- Accessories holder



OFFROAD MODE



ONROAD MODE



# AVENTURO CARBON 2



SENA Intercom not included

#### Helmet shell:

The exclusive use of carbon fibre for the helmet shell allows the combination of maximum safety standards at lowest weight.

Weight: from 1280gr (+/-50gr)

The aerodynamically optimised helmet shape was developed to minimise lift and turbulence.

#### Field of vision:

The large panorama field of view offers best all-round visibility and thus actively increases safety. This also makes the Aventuro Carbon2 ideal for wearers of spectacles.

#### Ventilation:

Perfect ventilation via 6 adjustable air inlets and 4 air outlets. Their effect is reinforced by optimised air channels made of EPS foam.

The removable chin air protector and the off-road air inlet increase air supply during off-road travel.

#### Helmet shield:

The specially shaped helmet shield offers best protection against dirt or sun at all times without interfering with the aerodynamics of the helmet. The correct size can be adjusted at any time via the extension with multiple settings developed especially for the Aventuro Carbon2.

**Visor:**

The scratch-resistant coated, three-dimensionally cast visor is fitted with a recess for mounting the supplied Pinlock™ inner visor. This combination effectively prevents misting and provides a clear field of vision under all weather conditions.

**Visor lock:**

The SuperLock ensures a securely closed visor. A special anti-fog position allows an open gap, ideal for city traffic.

The fast shot lock allows changing the visor with only two clicks.

**Fastener:**

A double D-ring closure provides safety. The extra-long chin strap provides greater comfort as the fastener does not need to be opened every time the helmet is taken off, the strap simply needs to be pulled over the tip of the nose.

**Emergency Strap:**

Offers an extra degree of safety. The padding can be quickly removed by rescue teams and the helmet can be taken off without risk to the spine.

**Conversion:**

The Aventuro Carbon2 can be converted from one version to another in 2 minutes without the need for any tools. No matter whether with helmet shield or not, with enduro goggles or not.

**Ready for intercom use:**

Perfectly positioned recesses inside the Aventuro Carbon2 and sufficient space on the outer shell of the helmet allow comfortable mounting of all common communication systems on the market.

**Holders and accessories:**

Two side and one overhead holding fixtures allow individual mounting of accessories such as helmet cameras. Whereby the overhead holding fixture can be mounted within seconds without the need for using tools.

Two specially developed side covers allow quick and precise fitting of QuickStrap™ goggle straps. Included exclusively in the scope of delivery of the Touratech Aventuro Carbon2.

Special side covers of the visor provide minimal noise interference when using the Aventuro Carbon2 without a helmet shield, i.e. on motorways.

**Transport pouch:**

The protection and transport pouch for accessories and visors make storage child's play on the road and ensure permanent scratch-free visibility.

**Certification:**

The Aventuro Carbon2 is dual-certified, both according to ECE 22.05 as well as according to DOT.



# AVENTURO CARBON 2



### Inner lining:

Inner lining made of Coolmax™, replaceable and washable. 3-dimensional pre-shaped cheek pads made of Coolmax™ with Emergency Strap System. Reflective zones on the underside of the pads increase visibility during poor weather and at night.

### Ergo Padding System:

The „Ergo Padding System“ enables optimal adjustment of the helmet to the individual head shape of the wearer using several foam pad strips.

### Rubber edge:

Soft lower edge made of rubber. Formed outwards in the chin area to prevent injuries of the upper sternum and collarbone. The rear section features an extension to protect against dripping water.



### Visor for Touratech Aventuro Carbon and Carbon2

500-9100 clear

500-9101 smoke 60%

500-9102 smoke 80%

### Pinlock™ linner visor

500-9103 clear

## Core+

500-3120	size XS
500-3121	size S
500-3122	size M
500-3123	size L
500-3124	size XL
500-3125	size XXL
500-3126	size XXXL



## White

500-2410	size XS
500-2411	size S
500-2412	size M
500-2413	size L
500-2414	size XL
500-2415	size XXL
500-2416	size XXXL



## Compañero+

500-3130	size XS
500-3131	size S
500-3132	size M
500-3133	size L
500-3134	size XL
500-3135	size XXL
500-3136	size XXXL



## Sport+

500-3140	size XS
500-3141	size S
500-3142	size M
500-3143	size L
500-3144	size XL
500-3145	size XXL
500-3146	size XXXL





TOURATECH  
**AVENTURO**  
**RAMBLER**



The Aventuro Rambler is the perfect companion for every big or small adventure. Whether on the off-road tour, the daily commute to work, a weekend trip or a round-the-world trip, in snow flurries, in the rain or scorching heat - the Aventuro Rambler offers the right thing for every use.

The Adventure helmet shines not only with its unique design, but also with features that provide maximum safety and comfort. Of course, the Aventuro Rambler meets all the safety standards that apply worldwide. Manufactured from fibreglass matrix proven a million times over.





Weight small outer shell (XS-S):  
1600 g „On-Road“ + „Off-Road“  
(1750 g „Travel“)

Weight middle outer shell (M-L):  
1625 g „On-Road“ + „Off-Road“  
(1775 g „Travel“)

Weight large outer shell (XL-3XL):  
1650 g „On-Road“ + „Off-Road“  
(1800 g „Travel“)

The most important features at a glance:

- Helmet shells in 3 sizes: XS-S, M-L, XL-3XL made of fibreglass for individual fit
- Intuitively operated sun visor
- 4 adjustable air inlets and 4 air outlets, easy to operate with gloves
- Inclination adjustable shield for best sun protection
- Windbreak at the chin (removable) provides the best possible comfort in cold or hot weather
- Aerodynamic design of the helmet and shield
- Best all-round visibility thanks to the visor size and thus higher active safety
- Integrated goggle strap guide
- Perfectly positioned cut-outs in the helmet for convenient mounting of all standard communication systems
- Super-fast, tool-free helmet conversion On-Road - Offroad - Travel
- 2 lateral and one upper head holder allow the individual attachment of accessories (Actioncams, Bluetooth, etc.)
- Emergency Straps for more safety
- Complies with ECE 2205 and DOT



### Aventuro Rambler Sunbeam

500-2450	size XS
500-2451	size S
500-2452	size M
500-2453	size L
500-2454	size XL
500-2455	size XXL
500-2456	size XXXL

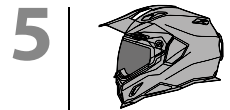

TRAVEL



OFFROAD



ONROAD



2

**1** The COOLMAX™ inner padding is replaceable and washable. The reflective strips on the underside increase visibility in bad weather and at night. The Ergo Padding System allows the helmet to be optimally adjusted to the individual head shape of the wearer using several foam padding strips.

2

**2** Perfect ventilation via 4 adjustable air inlets and 4 air outlets. Their effect is reinforced by optimised air channels made of EPS foam. The removable chin air protector and the off-road air inlet increase air supply during off-road travel.

3

**3** In the chin area, flared forward, and around the helmet there is a soft rubber edging to prevent injuries to the sternum and collarbone. In the rear area it also serves as protection against dripping water.

4

**4** The double D-ring allows the helmet to be closed individually, suitable for each head. The extra long chin strap provides more comfort, as the closure does not have to be opened every time the helmet is taken off, but the strap can simply be pulled over the tip of the nose. The helmet shield offers the best protection against dirt and sun at all times without ruining the aerodynamics of the helmet.

5

**5** The Aventuro Rambler can be converted from one version to another in 2 minutes without tools. No matter if with helmet shield or without, with Enduro glasses or without.

6

**6** Two lateral and one upper head mountings allow individual, tool-free attachment of accessories such as helmet cameras. Two specially developed side covers ensure quick and precise fitting of QuickStrap™ goggle straps. Special side covers of the visor ensure minimal noise pollution when used without a helmet shield.

7

**7** The 3-dimensional moulded visor is scratch-resistant coated and is prepared for quick mounting of the enclosed Pinlock™ visor. This combination effectively prevents fogging and ensures a clear view in all weather conditions. The visor can be folded down quickly and easily with a single hand movement, even with thick winter gloves. The SuperLock visor latch has a special anti-fog position, ideal for city traffic, and the Fast Shot quick lock enables visor replacement with just 2 clicks.

8

8

**8** In addition to the double certification (ECE 2205 and DOT), the Emergency Strap System offers an extra degree of safety. The padding can be quickly removed by rescue teams and the helmet can be taken off without risk to the spine.





### Touratech Aventuro goggles with Touratech strap

Modern design, high quality materials and excellent wear comfort make the Aventuro goggles the perfect offroad add-on for your new Aventuro helmet. It offers a large field of view and is also suitable for wearers of spectacles because of its O.T.G. construction.

Due to the flexible strap receptacle, which is separated from the goggle frame, the Aventuro goggles will fit virtually any helmet. Thus the goggle frame sits tightly on the face. No chance for draught or dust getting in the eyes! The 3-component foam offers perfect wear comfort with its perspiration-absorbing, anti-allergenic fleece surface and different thicknesses. The silicone ripples on the goggle strap ensure a perfect, non-slip fit to the helmet.

The AVS ventilating system provides an optimal climatic zone behind the glasses. This also offers the best possible protection against UV radiation, is free of fogging and scratch-proof.

#### The benefits at a glance:

- AVS ventilation system
- protection against UV radiation
- clear (cat. 0), scratch-proof goggle glasses with anti-fogging coating, without irritating pins
- O.T.G. (over the glasses) suitable for wearers of spectacles
- skin-friendly 3-layer goggle seal with open filter
- elastic Touratech goggle strap with non-slip silicone ripples

500-0174 black

500-0165 white



500-0175

### Strap Touratech

500-0175



500-0176

### Replacement lens

500-0176 clear

500-0178 grey

## Quick Straps

Highly practical goggle attachment to the Enduro helmet. Simply replace the goggle strap with the flexible Quick Straps. The goggles are firmly clicked into the helmet on the left and affixed variably on the right by means of a stable Velcro fastener. Perfectly matches nearly all commercially available cross-goggles.

500-0113 black



## Carrying strap Touratech

Whether for the tank bag, the rack pack or the helmet - the padded carrying strap Touratech is a real convenience in the transport of your luggage when the motorcycle is stationary.

- adjustable 80 cm to 140 cm
- width 4 cm
- padded

055-1621





TOURATECH  
**COMPAÑERO** BY STADLER  
SUMMER TRAVELLER



Certified motorcycle clothing

Photo: Martin Leonhardt

# ADV

MOTORCYCLE ADVENTURE SUIT

PROTECTION  
LEVEL 2



Be safe and ride free!

CERTIFIED  
MOTORCYCLE  
CLOTHING  
DIN EN  
17092-  
3:2020  
CLASS  
AA



TOURATECH  
**COMPAÑERO** BY STADLER  
 SUMMER TRAVELLER

## MOTORCYCLE ADVENTURE SUIT

The Compañero Summer Traveller is an airy summer suit that meets the highest possible safety standards.

Like the Compañero World2, the Compañero Summer Traveller has been designed to provide airflow over the largest possible surface area, an essential comfort factor at high temperatures and during physical exertion. Those parts that are vulnerable during a fall have been given a double layer of CORDURA® 2000 - a fabric with a particularly robust yarn thickness. In addition to protectors (Level 2) on knees, hips, elbows, back and shoulders, the Compañero Summer Traveller has been provided with an optional chest protector. To guarantee the greatest possible ventilation in this area, we have integrated two additional ventilation zips, which can be opened as needed.

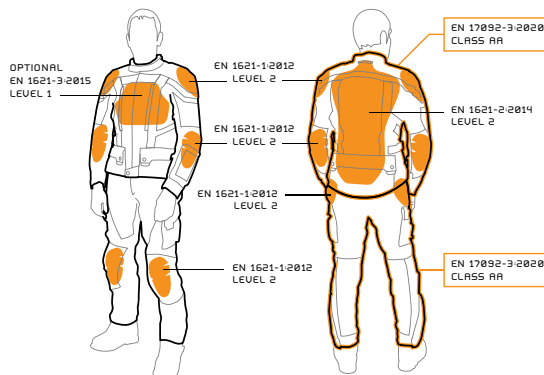

PROTECTION  
LEVEL 2

Typical Compañero features, such as the large reflective inserts for passive safety and the long connection zip between jacket and trousers, are among the proven features that we have incorporated in the Compañero Summer Traveller as well. Things that need to be within reach at all times can be stowed in the two waterproof outer pockets of the jacket. The spacious pocket on the back of the jacket offers space for larger items too. We've made the smartphone pocket on the forearm bigger, to fit larger devices. Valuable items disappear into the spacious inner pockets for better protection. A small zip pocket on the upper arm is the perfect place for the keyless-go key of modern motorcycles.

Thanks to the generous Velcro adjusters, you can adjust your jacket for an ideal fit.

The diagonal openings of the cargo pockets on the trousers also allow you easy access to your pockets when seated.

Thanks to the large Velcro fastener, the fit of the jacket can be changed easily.



## THE ULTIMATE SUMMER SUIT!



TOURATECH  
**COMPANERO** BY STADLER  
**SUMMER TRAVELLER**

**Special features:**

- Maximum air ventilation thanks to ventilation zips
- Joins to the waterproof, windproof and breathable all weather outer jacket via zips at the front
- Cargo pockets at the thighs
- Continuously adjustable waist and chest
- Belt loops, stretch strips and velcro fastener at the waistband
- Additional layer of CORDURA® 2000 at shoulders and elbows
- Soft collar lining
- Distance control (We have created a special padding to protect the membrane and reduce the appearance of a wet feeling. This provides good breathability even increasing the damping.)
- Tank protection
- Long zip to join suit together as an all-in-one

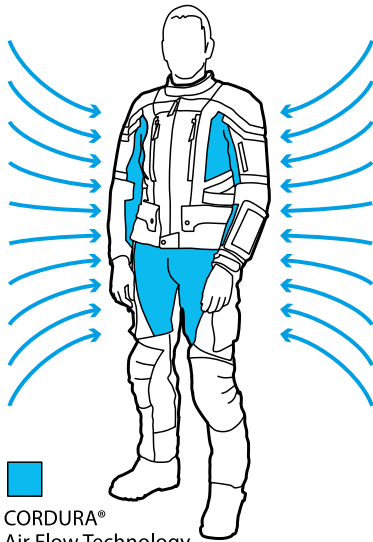

**CORDURA®**  
 Air Flow Technology

Maximum air ventilation at the front and back with CORDURA® Air Flow Technology

# MOTORCYCLE ADVENTURE SUIT



- Arm width adjuster (can be operated with one hand)
- Adjustable cuffs



Joins to the waterproof, windproof and breathable all weather outer jacket via zips at the front



Maximum air ventilation thanks to ventilation zips



See-through pocket on the lower arm.



Cargo pockets at the thighs



#### Material:

- CORDURA® 500, CORDURA® 2000
- Dynatec® reflex material in the shoulder area
- Interior side in synthetic leather in the knee area
- CORDURA® 2000 doubling at the shoulder, elbow and at the bottom of the legs
- Antibacterial mesh with spacer fabric at the back protector

**CORDURA®**  
BRAND

#### Pockets:

- 2 waterproof outer pockets
- 1 inner pocket
- 1 mobile phone pocket on forearm
- 1 small pocket on upper arm
- 1 spacious pocket on the back of the jacket

#### Upper:

- CORDURA® 100% polyamide
- dynatec 100% polyamide
- Lining: 100% polyamide

**STADLER®**



TOURATECH BY STADLER  
**COMPAÑERO**  
 SUMMER TRAVELLER



⑥



### Chest protector

The chest protector corresponds to the highest possible safety standard (Level 1). It is the perfect complement to the Compañero Summer/World Traveller and completes the Compañero's all-round protection. It does not restrict the driver's freedom of movement and is an absolute must for safe off-road driving.

510-1100



PROTECTION  
LEVEL 2

①

### back

EN 1621-2: 2014 / B, Level 2

②

### shoulder

EN 1621-1:2012 / S, Level 2

③

### elbow

EN 1621-1:2012 / E, Level 2

④

### hip

EN 1621-1:2012 / H, Level 2

⑤

### knee

EN 1621-1:2012 / K, Level 2

⑥

### chest protector

(optional)

# THE ULTIMATE SUMMER SUIT!



### Men Jacket | black

standard	Size	short	Size
511-1246	46	511-1225	25
511-1248	48	511-1226	26
511-1250	50	511-1227	27
511-1252	52	511-1228	28
511-1254	54	511-1229	29
511-1256	56	511-1230	30
511-1258	58	511-1231	31
511-1260	60		
511-1262	62	<b>long</b>	Size
511-1264	64	511-1202	102
		511-1206	106
		511-1210	110
		511-1214	114
		511-1218	118



### Men Pants | black

standard	Size	short	Size	long	Size
511-1146	46	511-1125	25	511-1102	102
511-1148	48	511-1126	26	511-1106	106
511-1150	50	511-1127	27	511-1110	110
511-1152	52	511-1128	28	511-1114	114
511-1154	54	511-1129	29	511-1118	118
511-1156	56	511-1130	30		
511-1158	58	511-1131	31		
511-1160	60				
511-1162	62				
511-1164	64				

### Women Jacket | black

standard	Size	Women Pants   black	Size
511-1236	36	511-1136	36
511-1238	38	511-1138	38
511-1240	40	511-1140	40
511-1242	42	511-1142	42
511-1244	44	511-1144	44





**Men Jacket | yellow**

standard	Size	short	Size	long	Size
510-1246	46	510-1225	25	510-1202	102
510-1248	48	510-1226	26	510-1206	106
510-1250	50	510-1227	27	510-1210	110
510-1252	52	510-1228	28	510-1214	114
510-1254	54	510-1229	29	510-1218	118
510-1256	56	510-1230	30		
510-1258	58	510-1231	31		
510-1260	60				
510-1262	62				
510-1264	64				



**Men Pants | yellow**

standard	Size	short	Size	long	Size
510-1146	46	510-1125	25	510-1102	102
510-1148	48	510-1126	26	510-1106	106
510-1150	50	510-1127	27	510-1110	110
510-1152	52	510-1128	28	510-1114	114
510-1154	54	510-1129	29	510-1118	118
510-1156	56	510-1130	30		
510-1158	58	510-1131	31		
510-1160	60				
510-1162	62				
510-1164	64				

**Women Jacket | yellow**

standard	Size
510-1236	36
510-1238	38
510-1240	40
510-1242	42
510-1244	44

**Women Pants | yellow**

standard	Size
510-1136	36
510-1138	38
510-1140	40
510-1142	42
510-1144	44



PROTECTION  
LEVEL 2



### Men Jacket | blue

standard	Size	short	Size
512-1246	46	512-1225	25
512-1248	48	512-1226	26
512-1250	50	512-1227	27
512-1252	52	512-1228	28
512-1254	54	512-1229	29
512-1256	56	512-1230	30
512-1258	58	512-1231	31
512-1260	60		
512-1262	62		
512-1264	64		





TOURATECH  
**COMPAÑERO**  
BY STADLER  
WEATHER TRAVELLER

MOTORCYCLE  
RAIN SUIT 



**THE ULTIMATE  
RAIN GEAR!**





### Compañero Weather Traveller

The Compañero Weather Traveller is a laminate rain suit for the Compañero Summer Traveller or any other suit. Its cut and design are perfectly matched to the Compañero Summer Traveller. This means that the protection suit can stay where it belongs and the weather protection comes on top. In this way, the laminate suit forms the second layer of the Compañero World Traveller for cooler days, rain or even snow.

It's a smart move to empty out your pockets first and place your essential items in the pockets of this overgarment. They are spacious, easily accessible and - of course - waterproof! Touratech has chosen the GORE-TEX three-layer laminate (CORDURA®). In this textile composite material, the inner lining, the top-quality GORE-TEX breathable membrane and the tough outer layer are bonded into one fabric. This means the laminate is not too bulky, doesn't bulge, and always fits nice and snugly. Of course the most important properties of the oversuit are that it is wind and waterproof. And since GORE-TEX three-layer laminate (CORDURA®) is an active material, the suit is fully breathable. What's clever with the Touratech Compañero World Traveller is that the windproof, waterproof membrane forms the outer layer of the clothing system. The airy summer suit keeps an air cushion inside that acts as a thermal lining. An additional insulating layer such as fleece underwear is only needed in extremely cold weather. In wintry conditions the optional storm collar will also be greatly appreciated. As you'd expect, the jacket and trousers of the membrane suit can also be zipped together. If you wear the laminate suit in uncertain weather conditions in spring or autumn, securely closable ventilation zips provide cooling if required.

2 Aquaseal zips on the front side and a long zip on the back guarantee an ideal ventilation and thus a great wearing comfort.

Extra long zips at the exterior side of the trousers make it easier to put them on or to take them off



The jacket can be packed into itself to save space for transport.

even when wearing boots. The 2-ways zip is also useful to reach through to the pockets of the summer trousers.

The additional membrane protection on the outside and the inside of the leg end of the trousers protects its high-quality materials against ugly chafing marks due to the frame of the bike and the buckles of the boots.

The jacket of this membrane suit is not only functional, but also very chic. It can match any functional jacket from the outdoor segment and is a practical, waterproof and breathable companion when strolling through town in the evening - as well as on any of those exceptional excursions where your bike is not allowed to accompany you. In this case, a detachable storm collar or hood can be fitted as an option.

#### Material:

- GORE-TEX Pro three-layer laminate (CORDURA®)
- YKK AquaSeal® zips
- Mesh lining (antibacterial)

#### Pockets:

- 2 waterproof outer pockets,
- 1 waterproof vertical zip pocket,
- 1 waterproof inner pocket

#### Upper:

- CORDURA® 100% polyamide
- Lining: 100% polyamide
- Membrane: PTFE (polytetrafluoroethylene)

#### Special features

- Ventilation through 2 AquaSeal® zips at the front side and 1 zip at the back
- Large reflectors
- Long zip to join suit together as an all-in-one
- Tank protection
- Arm width adjuster
- Adjustable cuffs
- Soft collar lining

#### Colour:

grey/yellow - black





TOURATECH  
**COMPANERO**  
BY STADLER  
WEATHER TRAVELLER

MOTORCYCLE  
RAIN SUIT 

**FITS OVER ALL STANDARD  
MOTORCYCLE SUITS!**



1

3

2

6

4

5





**1** Large reflectors

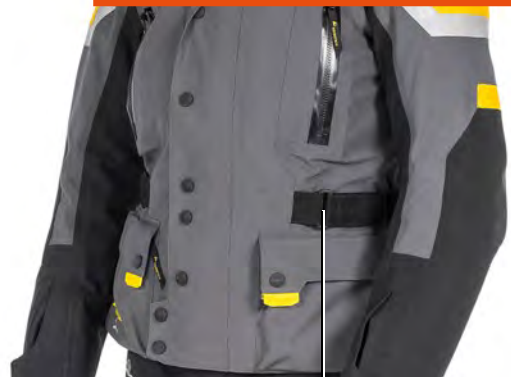

**2** Continuously adjustable waist and chest

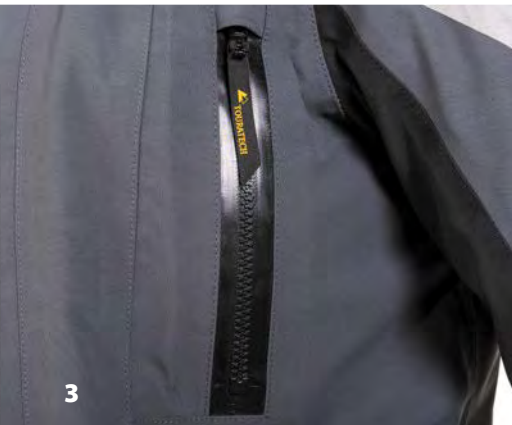

**3** Ventilation through 2 AquaSeal® zips at the front side and 1 zip at the back



**4** The 2-ways zip is also useful to reach through to the pockets of the summer trousers.



**5** Extra long zips at the exterior side of the trousers make it easier to put them on or to take them off even when wearing boots.



**6** Waterproof outer pockets, continuously adjustable waist



**FITS OVER ALL STANDARD MOTORCYCLE SUITS!**

**Men Jacket | black**

standard	Size	short	Size	long	Size
511-2246	46	511-2225	25	511-2202	102
511-2248	48	511-2226	26	511-2206	106
511-2250	50	511-2227	27	511-2210	110
511-2252	52	511-2228	28	511-2214	114
511-2254	54	511-2229	29	511-2218	118
511-2256	56	511-2230	30		
511-2258	58	511-2231	31		
511-2260	60				
511-2262	62				
511-2264	64				



**Men Pants | black**

standard	Size	short	Size	long	Size
511-2146	46	511-2125	25	511-2102	102
511-2148	48	511-2126	26	511-2106	106
511-2150	50	511-2127	27	511-2110	110
511-2152	52	511-2128	28	511-2114	114
511-2154	54	511-2129	29	511-2118	118
511-2156	56	511-2130	30		
511-2158	58	511-2131	31		
511-2160	60				
511-2162	62				
511-2164	64				

**Women Jacket | black**

standard	Size
511-2236	36
511-2238	38
511-2240	40
511-2242	42
511-2244	44

**Women Pants | black**

standard	Size
511-2136	36
511-2138	38
511-2140	40
511-2142	42
511-2144	44





## Men Jacket | yellow

standard	Size	short	Size	long	Size
510-2246	46	510-2225	25	510-2202	102
510-2248	48	510-2226	26	510-2206	106
510-2250	50	510-2227	27	510-2210	110
510-2252	52	510-2228	28	510-2214	114
510-2254	54	510-2229	29	510-2218	118
510-2256	56	510-2230	30		
510-2258	58	510-2231	31		
510-2260	60				
510-2262	62				
510-2264	64				



## Men Pants | yellow

standard	Size	short	Size	long	Size
510-2146	46	510-2125	25	510-2102	102
510-2148	48	510-2126	26	510-2106	106
510-2150	50	510-2127	27	510-2110	110
510-2152	52	510-2128	28	510-2114	114
510-2154	54	510-2129	29	510-2118	118
510-2156	56	510-2130	30		
510-2158	58	510-2131	31		
510-2160	60				
510-2162	62				
510-2164	64				

## Women Jacket | yellow

standard	Size
510-2236	36
510-2238	38
510-2240	40
510-2242	42
510-2244	44

## Women Pants | yellow

standard	Size
510-2136	36
510-2138	38
510-2140	40
510-2142	42
510-2144	44





TOURATECH BY STADLER  
**COMPAÑERO**  
 WORLD TRAVELLER

CERTIFIED  
 MOTORCYCLE  
 CLOTHING  
 DIN EN  
 17092-  
 3:2020  
 CLASS  
**AA**

## SUMMER + WEATHER

### Compañero World Traveller

Following our Worldwide and World2, we've created the third generation of probably the best adventure motorcycle suit - the Compañero World Traveller. The Compañero World Traveller takes the stage in a fresh, sporty design.

Together with our expert partner Stadler, we evaluated feedback from countless adventure bikers and discussed new ideas. This we did with the aim of making the best travel suit even better. Highest safety standard, absolute wearing comfort and clever features are the result.

With the Compañero World Traveller the name says it all: a reliable travel companion to accompany you around the world. Whether you're dealing with the scorching heat of the Sahara, continuous rain in the tropics or the freezing cold of Alaska, the Compañero World Traveller offers maximum comfort and safety at all times.



Summer suit



Weather suit



PROTECTION  
LEVEL 2

Certified motorcycle clothing



### Our concept

When developing the Compañero World Traveller, we remained true to the proven system comprising an airy summer suit and a warm weatherproof suit. As well as ensuring that the suit provides maximum ventilation at high temperatures and during physical exertion, we've paid special attention to safety. The best possible protection is just about good enough for us. Absolute wind and water tightness in adverse weather conditions is a given. Sophisticated features, as well as width adjustment for a perfect fit, variable cuffs and extra ventilation zips, are a matter of course when two competent partners such as Touratech and Stadler work in cooperation.

The zips have the same length as the ones used on the Compañero Worldwide, World2 and Boreal, so that the rider may combine freely the jacket and the trousers with those of these models.

With their level 2, the protectors are state-of-the-art. They offer maximal safety on all endangered zones! Of course, they can be freely positioned, as no one wears a protector if it feels uncomfortable.



PROTECTION  
LEVEL 2



CERTIFIED  
MOTORCYCLE  
CLOTHING  
DIN EN  
17092-  
3:2020  
CLASS  
AA



TOURATECH  
**COMPAÑERO** BY STADLER  
 WORLD TRAVELLER

# SUMMER + WEATHER

CORDURA® Air fabric makes the Summer Traveller suit breezy and more resilient at the same time



Compañero Weather Traveller with three air vents ; two watertight YKK AQUASEAL® front zipper, one well covered zip on the back



Compañero Weather Traveller: Lighter, but still extremely rugged three-layer-laminate by GORE-TEX®





### Men Jacket | black

standard	Size	short	Size	long	Size
511-3246	46	511-3225	25	511-3202	102
511-3248	48	511-3226	26	511-3206	106
511-3250	50	511-3227	27	511-3210	110
511-3252	52	511-3228	28	511-3214	114
511-3254	54	511-3229	29	511-3218	118
511-3256	56	511-3230	30		
511-3258	58	511-3231	31		
511-3260	60				
511-3262	62				
511-3264	64				



### Men Pants | black

standard	Size	short	Size	long	Size
511-3146	46	511-3125	25	511-3102	102
511-3148	48	511-3126	26	511-3106	106
511-3150	50	511-3127	27	511-3110	110
511-3152	52	511-3128	28	511-3114	114
511-3154	54	511-3129	29	511-3118	118
511-3156	56	511-3130	30		
511-3158	58	511-3131	31		
511-3160	60				
511-3162	62				
511-3164	64				

### Women Jacket | black

standard	Size
511-3236	36
511-3238	38
511-3240	40
511-3242	42
511-3244	44

### Women Pants | black

standard	Size
511-3136	36
511-3138	38
511-3140	40
511-3142	42
511-3144	44



### Women Jacket | yellow

standard	Size
510-3236	36
510-3238	38
510-3240	40
510-3242	42
510-3244	44

### Women Pants | yellow

standard	Size
510-3136	36
510-3138	38
510-3140	40
510-3142	42
510-3144	44

**SUMMER + WEATHER**

**Men Jacket | yellow**

<b>standard</b>	<b>Size</b>	<b>short</b>	<b>Size</b>	<b>long</b>	<b>Size</b>
510-3246	46	510-3225	25	510-3202	102
510-3248	48	510-3226	26	510-3206	106
510-3250	50	510-3227	27	510-3210	110
510-3252	52	510-3228	28	510-3214	114
510-3254	54	510-3229	29	510-3218	118
510-3256	56	510-3230	30		
510-3258	58	510-3231	31		
510-3260	60				
510-3262	62				
510-3264	64				

**Men Pants | yellow**

<b>standard</b>	<b>Size</b>	<b>short</b>	<b>Size</b>	<b>long</b>	<b>Size</b>
510-3146	46	510-3125	25	510-3102	102
510-3148	48	510-3126	26	510-3106	106
510-3150	50	510-3127	27	510-3110	110
510-3152	52	510-3128	28	510-3114	114
510-3154	54	510-3129	29	510-3118	118
510-3156	56	510-3130	30		
510-3158	58	510-3131	31		
510-3160	60				
510-3162	62				
510-3164	64				

**Men Jacket | blue / black**

<b>standard</b>	<b>Size</b>	<b>short</b>	<b>Size</b>
512-3246	46	512-3225	25
512-3248	48	512-3226	26
512-3250	50	512-3227	27
512-3252	52	512-3228	28
512-3254	54	512-3229	29
512-3256	56	512-3230	30
512-3258	58	512-3231	31
512-3260	60		
512-3262	62		
512-3264	64		





TOURATECH

REVIT!

# COMPAÑERO RAMBLER





 TOURATECH

 REVIT!

# COMPAÑERO RAMBLER

Probably the airiest GORE-TEX motorcycle suit in the world right now!

The combined experience of two leading motorcycle outfitters, the highest quality materials and the most advanced technologies.

Result: The Compañero Rambler – the perfect all-season touring suit!



# ALL CONDITIONS

CERTIFIED  
MOTORCYCLE  
CLOTHING

DIN EN  
17092-  
3:2020

CLASS  
AA

## Concept

The Compañero Rambler is an absolutely waterproof, breathable all-season touring suit, designed to meet the highest demands, made from the highest quality Gore-Tex 3-layer laminate. The quality and the well thought-out construction as well as the use of the best materials ensure an extremely wide range of applications. The Touratech Compañero Rambler was developed in collaboration with the renowned motorcycle clothing manufacturer Revit.

You'll be comfortable and safe on the road in anything from near-freezing temperatures to tropical conditions. Extensive and novel ventilation elements on the one hand and the warming absolutely windproof outer skin on the other are supported by a fully-fledged leisure jacket as inner lining.

The fit is perfect for sporty, active riders and is admirably suited to fast motorway stages or off-road riding during enduro hikes along lonely tracks.

The Compañero Rambler is up to tackling any weather!



PROTECTION  
LEVEL 2



## VENTILATION

- 1 x VCS main zip with 3 cm ventilation opening
- 2 x VCS AQUADEFENSE ventilation flaps on the chest (women via ventilation zip)
- 2 x ventilation zips on the upper arm
- 2 x vent zips on the back
- 2 x VCS AQUADEFENSE ventilation flaps on the upper leg
- The yellow BALLISTIC MESH of the vents matches all the qualities of an outer material!

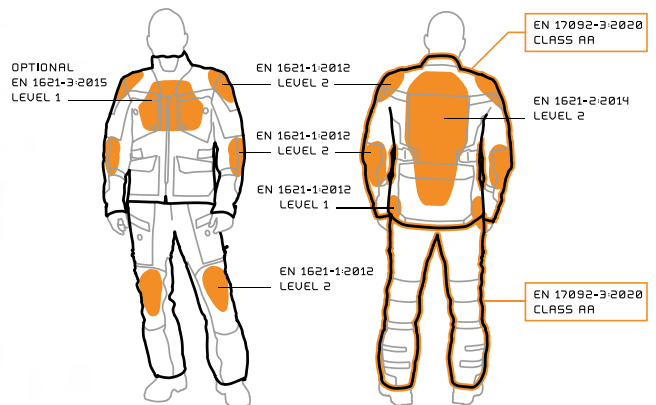





### Air cooling

A special point of focus is the ventilation function of Revit's patented VCS AQUADEFENSE system (EU patent EP 2574249, US patent US 13/630.520), which is integrated in both jacket and trousers. This system consists of flap openings that can be opened up when required, to expose large ventilation areas. They are held open, flutter-free, by FIDLOCK magnetic closures and allow direct ventilation of the body. These special magnets ensure an absolutely secure hold and can be operated with one hand. When closed, the AQUADEFENSE system is 100% wind and waterproof!

The large VCS (Ventilation Control System) front ventilation consists of a 3 cm wide ventilation gap and a double zip, whereby the opening height of the outer zip determines the amount of cooling air. The second zip ensures that the jacket still remains securely closed. When closed, the outer zip from the high-quality brand TIZIP guarantees absolute wind and waterproofness!

All VCS vents are backed with a three-dimensional BALLISTIC MESH gauze fabric.

Two ventilation zips, with waterproof construction, ensure ventilation of the upper arms, and two carefully positioned vent zips at the back guarantee the required airflow.

### Ergonomics and fit

The entire suit is as light as it can be while still complying with the test specifications for protective clothing. This helps you maintain your condition and especially your concentration while riding.

In addition to the perfect cut, stretch zones at the knees, waist and buttocks ensure a comfortable fit and additional freedom of movement, to further increase riding comfort. Optimally positioned compression straps - steplessly and individually adjustable at the chest, back, calf and forearm - are equipped with width adjusters and can be easily operated.

The Touratech Compañero Rambler has a comprehensive set of protectors, consisting of certified back, shoulder, elbow, hip and knee protectors. All these protectors are located in places where they can guarantee protection even with the vents fully open. Elbow and knee protectors can be attached at adjustable heights. The back protector is in a pocket made of open-pored 3D mesh. This supports the removal of water vapour and improves breathability and ventilation.

SEEFLEX



SEESMART



SEESOFT





## Jacket

The thought-through details of this jacket, such as the separation of the sleeve width adjusters at the wrist from the opening zip, makes it easier to put on and take off. The zips at the jacket hem allow stretch zones for maximum freedom of movement and comfort. A comfortable feature is the soft collar closure with concealed zip attachment.

The integrated, detachable kidney belt with a small zipped pocket stabilises and supports the lower back and provides a secure place for credit cards or small change, and it can be stored invisibly in the lining of the jacket when not in use.



## POCKETS

- 2 x jacket outer pockets (waterproof) with zips
- 1 x large pocket on the back of the jacket (waterproof) with zip
- 2 x jacket inner pockets with zips
- 2 x credit card pockets inside jacket
- 1 x pocket in kidney belt with zip
- 3 x pockets in the leisure jacket with zips
- 2 x pockets trousers (waterproof) with zips



## Trousers

2 connecting zips each on both jacket and trousers enable a secure connection. The dual design also ensures that it can be used with a large number of REVIT products.

The continuously adjustable compression straps facilitate the width adjustment of the trousers at the waist, concealing the fixtures for attaching braces inside. These trousers have a classic, removable lining. Features such as the leather inner leg that extends far above the knee, or the ARMACOR reinforced seat area with additional anti-slip trimmings, serve to provide better control and a secure grip on your motorcycle.



## Quality

The GORE-TEX Pro 3-layer laminate, used extensively in the Compañero Rambler, with double layers in the vulnerable areas and reflective material on the upper body and legs, was developed for riding in extreme conditions. The membrane is bonded between the durable outer layer and a robust inner material and provides an incredible 28,000 millimetre water column for ultimate waterproofness, stopping the material from becoming soaked. This accelerates drying, prevents evaporative cooling and blows away the water droplets as they drip off in the airstream.

The areas at risk in the event of a fall are particularly resistant thanks to the ARMACOR material, an extremely tear- and abrasion-resistant synthetic fibre material from GORE reinforced with KEVLAR threads.

The 3M SCOTCHLITE reflective material sends incident light, tightly focused, back towards the light source by means of extremely high reflectivity, resulting in significantly improved visibility at dusk and in the dark.

Zips from market leaders YKK and TIZIP as well as magnetic closures from FIDLOCK demonstrate the use of the very best materials.

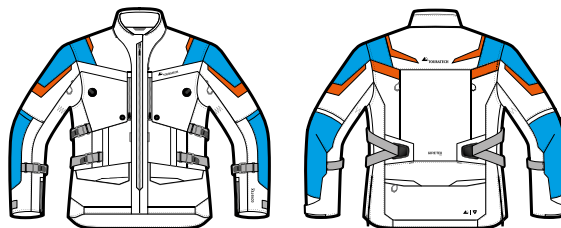

- GORE-TEX® Pro + ARMACOR® / KEVLAR®
- REFLEX

### MATERIAL

- GORE-TEX® PRO 3-LAYER LAMINATE
- GORE-TEX® PRO 3-LAYER LAMINATE ARMACOR® WITH KEVLAR®
- TIZIP® AND YKK® ZIPS
- FIDLOCK® MAGNETIC CLOSURES
- 3M™ SCOTCHLITE™ REFLECTIVE MATERIAL IN THE SHOULDER AREA

## Chest Protector for Compañero Rambler jacket

For those seeking additional armor for their jacket, we offer the available SEESOFT™ CE-level 1 divided chest protectors. They can easily be inserted into a select variety of our jackets that come prepared with the proper pockets. In the case of an impact, these protectors absorb and distribute energy away from the rider. Furthermore, the flexibility incisions around the ventilation points provide the rider with a proper fit. Suitable for:

- Compañero Rambler jacket
- REV'IT! Sand 4 jacket
- REV'IT! Poseidon 2 GTX jacket

515-1265





### Leisure and inner jacket

On cold days, the windproof, water-repellent and highly breathable leisure and inner jacket comes into its own. This is zipped into the motorcycle jacket and is made of HYDRATEX® Windbarrier®, a 3-layer laminate with a super-soft inside surface, a membrane and RIPSTOP outer material. It therefore provides a perfect warming lining.

At the same time, the warm, lightweight inner jacket functions as a comfortable-to-wear leisure jacket with a sporty cut and high functionality due to its three closable outer pockets and small pack size.

### Storm collar

The high-cut, adjustable, fully removable or foldable storm collar with GORE-TEX Pro 3-layer laminate is 100% windproof and waterproof. The chin area is made of soft, skin-friendly neoprene.



## Men Jacket | black

standard    Size

515-1248	48
515-1250	50
515-1252	52
515-1254	54
515-1256	56
515-1258	58
515-1260	60



## Men Jacket | stone

standard    Size

514-1248	48
514-1250	50
514-1252	52
514-1254	54
514-1256	56
514-1258	58
514-1260	60



## Men Pants | black

standard    Size

515-1148	48
515-1150	50
515-1152	52
515-1154	54
515-1156	56
515-1158	58
515-1160	60

## Men Pants | stone

standard    Size

514-1148	48
514-1150	50
514-1152	52
514-1154	54
514-1156	56
514-1158	58
514-1160	60



## Women Jacket | stone

standard    Size

514-1234	34
514-1236	36
514-1238	38
514-1240	40
514-1242	42
514-1244	44
514-1245	46



## Women Pants | stone

standard    Size

514-1134	34
514-1136	36
514-1138	38
514-1140	40
514-1142	42
514-1144	44
514-1145	46





### COMPAÑERO Travel-ler Storm collar

Rainproof from head to toe. The storm collar system is made from GORE-TEX 3-layer laminate. The inside is lined with skin-friendly microfibre. Snap fasteners attach the storm collar to your jacket's neck. The storm collar and your jacket collar can both be done up at the same time.

Material: GORE-TEX Pro Shell 3-layers, skin-friendly Mikrofaser  
Colour: Black

#### Storm collar for Jacket | size Men

501-3302	size 2
501-3303	size 3
501-3304	size 4
501-3305	size 5

size 2: 46  
size 3: 25, 48-52, 102-106  
size 4: 26-28, 54-58, 110-118  
size 5: 29-31, 60-64

#### Storm collar for Jacket | size Women

501-3301	size 1
501-3302	size 2
501-3303	size 3

size 1: 36-40, 76-80  
size 2: 20-22, 42-44, 84  
size 3: 23-24



### COMPAÑERO Travel-ler hood

Rainproof from head to toe.

Material: GORE-TEX Pro Shell 3-layers, skin-friendly Mikrofaser  
Color: Black

#### Hood for Jacket-size Men

501-3312	size 2
501-3313	size 3
501-3314	size 4
501-3315	size 5

size 2: 46  
size 3: 25, 48-52, 102-106  
size 4: 26-28, 54-58, 110-118  
size 5: 29-31, 60-64

#### Hood for Jacket-size Women

501-3311	size 1
501-3312	size 2
501-3313	size 3

size 1: 36-40, 76-80  
size 2: 20-22, 42-44, 84  
size 3: 23-24



## Storm collar STORM II

### Rainproof when it counts!

The STORM II storm collar was specially developed for the Compañero Weather Traveller jacket. It is made of flexible but 100% waterproof GORE-Tex® stretch material.

The storm collar is fixed to the jacket collar with a press stud and offers absolute comfort in bad weather.

The reflective logo provides additional passive safety.

### Features:

- Small pack size
- Can be used as required
- Easy to remove, even with gloves on

Material: 100% nylon

### Sizes:

1 = approx. head width XS - M

2 = approx. head width L - XXL

501-3307 size 1

501-3308 size 2



## COMPAÑERO Traveller braces

Elastic braces with synthetic leather and snap fasteners.

501-3321 size 1

501-3322 size 2

501-3323 size 3

501-3324 size 4

	men	women
size 1	-	36-40, 20
size 2	48-52, 25-26	42-44, 21-23, 76-80
size 3	54-58, 27-29, 102-106	24
size 4	60-64, 30-31, 10-118	-





Photo: Simon Cudby





**COMPAÑERO Rambler braces**

Suspenders Rambler, one size, black

1514-1100 one size



Image similar

**Hydration pack Compañero 2**

Once again we put all our experience in a big pot, turned up the heat, and gave it a good stir. The result? We've created the Touratech "Compañero 2" – the ultimate hydration pack!

055-0275 yellow without hydration reservoir

055-0276 yellow with 2 l hydration reservoir

055-0277 grey without hydration reservoir

055-0278 grey with 2 l hydration reservoir





Rain Cover

## TOURATECH ADVENTURE 2 rucksack

We have developed a rucksack that meets almost every requirement an adventure traveller could have! On a motorbike, bicycle or hiking - it even looks good in the city! There's plenty of space in the „Touratech Adventure“ for everything you could possibly need when you're on the go. All divided into various compartments - but with no loss of clarity. The special shape, innovative interior and first-class Airstripes carrying system guarantee the perfect fit in any situation. The rucksack for bikers!

### New features:

- Extended, rollable compression straps function as helmet holders
- Additional inner pockets
- Extended breathable shoulder straps
- Rain cover in neon yellow with a reflective TOURATECH logo keeps the contents absolutely dry even after long periods of rain
- Zipper slider with a press stud prevents it from opening by itself

- Spacious front pocket holds all the important things close at hand, including keys
- Side compression straps adjust the volume so the weight can be placed as close as possible to the body or additional equipment can be attached.
- Removable mat stabilises the rucksack and is a comfortable seat when enjoying a snack at the top
- Large 3M reflective surfaces provide greater safety in the rain and dark
- Elastic drawstring on the top for the easy attachment of light objects
- Mesh outer pockets keep drinking bottles, maps and a hat within reach
- Slide compartment for hydration system in the main compartment; with tube holes
- Separate base compartment with detachable base keeps the contents in place
- Quick release fasteners on the straps make it easy to put on - even over a jacket
- The Airstripes back system for the perfect wear comfort

Capacity: approx. 30 litres

Material: 210d Nylon, Super-Polytex 600d Polyester

**055-0260 yellow/black**





### Properties/features rain trousers:

- Waterproof and breathable membrane
- Zip for joining to the jacket
- Elastic waistband
- Long zip on the trouser leg
- Elastic and velcro fastener on the trouser legs
- Reflective material on the trouser legs
- Anti-slip trimming on the trouser seat
- YKK zips

500-2346 size S

500-2347 size M

500-2348 size L

500-2349 size XL

500-2350 size 2XL

500-2351 size 3XL

## Rain jacket and trousers with membrane, black

### Classical, practical, good!

This raincoat comes with no new-fangled frills but with functional details, simply fulfilling its purpose: protection against rain and cold. In addition, the breathable membrane guards against heat exhaustion and sweating in the summer. The hood, integrated in the collar, prevents water penetrating between the helmet and jacket collar.

Together with the rain trousers, the perfect combination to defy any kind of weather!

Outer material: 100% polyamide, lining 100% polyester



### Properties/features rain jacket:

- Waterproof and breathable membrane
- Hood integrated in the jacket collar
- Elastic band at the hips
- Elastic cord in the jacket seam
- Elastic and velcro fasteners on the sleeves
- Reflective material on upper body and arms
- Front zip sealed with velcro fastener
- One inner pocket behind the velcro fastener
- Good visibility through neon yellow on the upper body and upper arms
- YKK zips

500-2340 size S

500-2341 size M

500-2342 size L

500-2343 size XL

500-2344 size 2XL

500-2345 size 3XL



# PRIMERO

FUNCTIONAL UNDERWEAR

FROM COLD TO HOT CLIMATE

TEMPERATURE RANGE





# PRIMERO ALLROAD 2

The improved and redesigned functional underwear of the Primero Allroad2 series is the perfect companion for your tours.

The lightweight among functional underwear provides optimal wicking and fast redrying. This supports the ventilation of your riding gear. The body temperature is maintained at the ideal temperature of 37°C; on hot days the „Allroad2“ series has a cooling effect, and on cold days, a warming effect. The ideal shape was designed to offer high wear comfort. Few and flat seams make sure that the material fits your body like a second skin. Creases and friction are avoided.

Material: 78% polyamide, 22% polyester

## FEATURES

- few and extremely flat seams
- odour-neutralising and antibacterial
- high degree of breathability
- body-shaped fit
- men and women cut

TEMPERATURE RANGE



## Longshirt „Allroad 2“, Men

070-1234	size	M
070-1235	size	L
070-1236	size	XL
070-1237	size	2XL



## T-Shirt „Allroad 2“, Men

070-1230	size	M
070-1231	size	L
070-1232	size	XL







Photo: Simon Cudby









# PRIMERO STORM

TEMPERATURE RANGE



Functional wear that does not only look good but also is true to its name. When you wear the Touratech Primero Storm, you feel comfortable at any temperature and any weather!

The use of a special membrane makes the „Touratech Primero Storm“ completely wind-proof and still breathable. Moreover, the high-tech multi-channel fibres allow a great dampness transport outward, so that you get a pleasant sensation of dryness. Thermoregulating hollow fibres protect your body against hypothermia and big temperature variations.

- Wind-proof membrane
- Comfortable fit
- High breathability
- Great dampness transport outward
- Pleasant sensation of dryness when wearing it
- Cooling at warm weather - warming at cold weather
- Perfect all-year-round clothing

Material: 58% polyester, 38% polyamide, 4% elastane



## Longtight „Touratech Primero Storm“ men

070-1310	size	M
070-1311	size	L
070-1312	size	XL
070-1313	size	XXL

### Longshirt „Touratech Primero Storm“ women

Breathable 3D-structured elements in the back offer an additional support function in the lumbar region and thus more comfort for you!

070-1305 size S

070-1306 size M

070-1307 size L

### Longtights „Touratech Primero Storm“ women

070-1315 size S

070-1316 size M

070-1317 size L

- Wind-proof membrane
- Comfortable fit
- High breathability
- Great dampness transport outward
- Pleasant sensation of dryness when wearing it
- Cooling at warm weather - warming at cold weather
- Perfect all-year-round clothing

**Material: 58% polyester, 38% polyamide, 4% elastane**





## Longshirt „Touratech Primero Alpine“ women

070-1075 size S

070-1076 size M

070-1077 size L

- Lightweight, warming Longtights with high Piqué cuff (240g/m<sup>2</sup>)
- Lightweight, warming Longshirt with stand-up collar and zipper (240g/m<sup>2</sup>)
- Lightweight net cuffs envelope the shins and prevent pressure marks caused by stockings and motorcycle boots
- Comfortable fit
- Soft cuffs without irritating seams
- Antistatic effect
- High breathability
- Pleasant dry wearing comfort
- Keeps you warm in the winter

Material:

80% polypropylene, 20% polyamide

## Longtight „Touratech Primero Alpine“ women

070-1085 size S

070-1086 size M

070-1087 size L





# PRIMERO NATURE ACTIVE

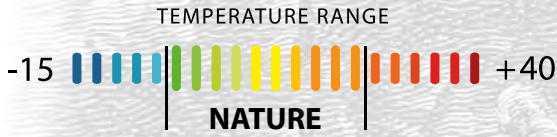

Natural functional underwear made of genuine merino wool! The unique fibre structure of fine merino wool ensures skin-friendly, scratch-free comfort and ideal moisture transport - the smell of sweat has no chance! Merino underwear cools in summer and warms in winter - even if it gets wet! In addition to the special properties of merino wool, the Touratech functional shirts „Primero Nature Active“ also stand out due to their certified raw material origin and extremely high-quality workmanship. Put it on - feel good - full concentration on your motorcycle!

## T-Shirt „Touratech Primero Nature Active“ men



- 070-1248 size S
- 070-1249 size M
- 070-1250 size L
- 070-1251 size XL
- 070-1252 size XXL
- 070-1253 size XXXL



## Longshirt „Touratech Primero Nature Active“ men

- 070-1254 size S
- 070-1255 size M
- 070-1256 size L
- 070-1257 size XL
- 070-1258 size XXL
- 070-1259 size XXXL

**Material:**  
 96% wool  
 4% elastane  
 Contains non-textile parts of animal origin



## Longshirt „Touratech Primero Nature Active“ women



070-1260	size XS
070-1261	size S
070-1262	size M
070-1263	size L
070-1264	size XL



**PRIMERO**  
FUNCTIONAL UNDERWEAR



- Certified origin
- High-quality „Made in Europe“ workmanship
- Scratch-free thanks to the use of finest Merino wool
- Closer cut for unrestricted freedom of movement
- Super wearing comfort - directs moisture away from the body to the inside of the fibre
- Odourless even during heavy physical activity
- High breathability
- Can be worn all year round
- Natural UV protection
- Antibacterial
- Absolutely easy care - machine washable





# MX RIDE





- Lightweight, thin and well ventilated
- Palm made of synthetic leather
- Outer made of tear-proof fabric
- Neoprene cuffs
- Doubled material at thumb
- Overturned material at index and middle finger
- Expanded material for better fit at finger joints
- Ventilation holes for fingers on palm
- Velcro strap for adaptation to wrist size
- Silicone imprint on palm and finger tips
- Sizes: 7 to 13
- Material: 50% polyester, 40% synthetic leather, 4% neoprene, 3% silicone, 3% rubber

## Gloves Touratech MX-Ride

The Touratech gloves „MX-Ride“ are lightweight motocross gloves. These gloves were developed to provide offroad riders with maximum comfort and control.

The MX-Ride is lightweight and thin, appropriate to its use at medium and high temperatures in difficult terrain, and yet offers solid protection.

The palm is made of abrasion-resistant and very tactile synthetic leather. A single pattern piece is used here to avoid any weak points due to seams. A silicone imprint on the palm and the fingertips provides perfect grip on handlebar and levers.

A neoprene cuff allows perfect fitting to the wrist through its comfortable elasticity. A velcro closure provides secure closing. A double layer of material protects the pressure-exposed parts of the thumb against blisters.

A double layer of material also prevents annoying seams at the fingertips. Additional ventilation holes permit good heat dissipation in conjunction with the airy upper material.

size	yellow	orange	grew	blue
7 / S	500-5000	500-5010	500-5020	500-5030
8 / M	500-5001	500-5011	500-5021	500-5031
9 / L	500-5002	500-5012	500-5022	500-5032
10 / XL	500-5003	500-5013	500-5023	500-5033
11 / XXL	500-5004	500-5014	500-5024	500-5034
12 / XXXL	500-5005	500-5015	500-5025	500-5035
13 / XXXXL	500-5006	500-5016	500-5026	500-5036





# GUARDO DESERT+



## Glove Touratech Guardo Desert+

The airy, lightweight summer glove - not just for desert expeditions!

Guardo Desert+ gloves are airy enough to prevent sweaty hands and still offer excellent grip and effective protection. So don't accept any compromises and choose Guardo Desert+ when the heat is on!

- Unlined summer glove
- Highly wear-resistant goat leather palm, 100% (Contains non-textile parts of animal origin!)
- Polyester upper (100%) with leather trim
- Velcro at the cuff
- Padded inserts on the fingers
- Soft knuckle protection for high comfort
- Hand edge reinforcement with SUPERFABRIC®
- Certified to DIN EN 13594: 2015 „Protective gloves for motorcyclists“

CERTIFIED  
DIN EN  
13594:2015



500-1980	size 7/S
500-1981	size 8/M
500-1982	size 9/L
500-1983	size 10/XL
500-1984	size 11/XXL
500-1985	size 12/XXXL



**CERTIFIED  
DIN EN  
13594:2015**



## GUARDO ALPINE2

### Glove Touratech Guardo Alpine2

Whether tour rider, globetrotter or occasional driver - the Touratech Alpine2 gloves combine safety with absolute comfort.

The pre-formed hand shape, effectively prevents wrinkling of the material when you grip the handlebars. The thinner palm lining (compared to the thicker shell lining) increases your grip on the handlebars, clutch and brake levers, without restricting the fundamental warming function of the gloves. In addition, the effect of any existing grip heating is more noticeable.

This and the additionally reinforced palm provide you with the grip you need in order to have your bike under control in every situation. A further safety element is provided in the form of hand edge reinforcements with SUPERFABRIC® - an all too often forgotten area of hand protection.

The Guardo Alpine2 is a lined tour glove made of leather, for the spring and autumn.

#### Material:

Palm: 100 % leather

Back: 100 % leather

Membrane: 100 % polyurethan

Lining: 100 % polyester

(Contains non-textile parts of animal origin)

#### Features:

- Back and palm made of goatskin
- Palm reinforcement with sheepskin
- Hand edge reinforcement with SUPERFABRIC®
- Breathable, wind and waterproof polyurethane membrane
- Warm lining
- Elastic inserts on the fingers and wrist
- Velcro width adjustment on wrist and cuff
- Visor wiper lip
- Certified to DIN EN 13594:2015: „Protective gloves for motorcyclists“

500-2045	size 7/S
500-2046	size 8/M
500-2047	size 9/L
500-2048	size 10/XL
500-2049	size 11/XXL
500-2050	size 12/XXXL



# GUARDO RAIN



## Features:

- Back and palm made of polyamide
- Anti-slip trimming along the index finger and middle finger
- Material on the sides of index finger and thumb made of polyester and polyurethane (visor wiper function)
- Waterproof and breathable polyurethane membrane
- Polyester lining
- Reflective material
- Elastic wristband
- Width adjustment with drawstring at the top of the glove

## Glove Touratech Guardo RAIN

The Guardo Rain is a high quality rain-proof overglove made of durable Ripstop Nylon with waterproof membrane and a lightweight polyester lining.

Classic rain protection with up-to-date technologies newly interpreted: that's the Guardo Rain. Ripstop nylon, a textile material which is particularly tear-resistant due woven-in, reinforced threads, gives these rain gloves their robustness. The membrane is made of polyurethane which repels rainwater reliably, even at high speeds. A special feature is the soft blend of polyester and polyurethane used on the side of the index finger and thumb. This makes it possible to effectively wipe water from the helmet visor - a classic, protruding wiper lip is superfluous.

Thanks to the low weight and compact dimensions, you can have your Guardo Rain with you at all times - and be immune to wet surprises.

500-2051	size 7/S
500-2052	size 8/M
500-2053	size 9/L
500-2054	size 10/XL
500-2055	size 11/XXL
500-2056	size 12/XXXL

Back: 100% polyamide  
Lining: 100% polyester  
Membrane: 100% polyurethan

## GUARDO WORLD



## GUARDO ADVENTURE



## GUARDO MONSOON

### Glove Touratech Guardo WORLD (Adventure + Monsoon)

Guardo World gloves take up the design principle of the Compañero touring suit. Due to the two-piece design, they can be worn in many different situations. Guardo World summer gloves made from a textile/leather mix, and the weather-proof outer gloves complement each other to form a versatile clothing system. The Guardo World is a real all-rounder for all weather conditions from spring to autumn.

# GUARDO ADVENTURE

CERTIFIED  
DIN EN  
13594:2015



## Features Adventure

### Textile / leather summer glove with Sharktec palm

The shell structure made of goatskin, neoprene and two-way Spandex on the backs of the fingers, in conjunction with the palm made of Sharktec 3D, make these summer gloves airy, comfortable and extremely robust at the same time.

In addition to the nearly indestructible Sharktec, finger knuckle protectors on the middle, ring and little fingers, base knuckle protection, as well as reinforcement of the hand heel and hand edge with Superfabric® provide high-level protection. Certification to DIN EN 13594:2015: „Protective gloves for motorcyclists“ is a matter of course.

The elastic 3D volcano technology ensures a secure grip at maximum vibration absorption. This dynamic 3D Pyramid technology has a shock and vibration absorbing effect. Generously used stretch material and the cuffs with velcro fasteners guarantee a secure and comfortable fit. A special highlight are the tips of the thumb and index finger with touch screen capability.

**Palm:**  
100 % leather / 96 % polyester, 4 % elasthan

**Back:**  
50 % para aramid, 50 % polyglass / 100% silicon

**Lining:** 100 % polyester

(Contains non-textile parts of animal origin)

- Sharktec 3D palm with nano technology
- Enormous grip due to elastic 3D volcano technology
- Flame resistant
- Cut resistant
- Vibration absorbing through dynamic 3D-pyramid technology
- Touchscreen capability on index finger and thumb
- Back with goatskin, neoprene and 2-way Spandex on the backs of the fingers
- Reflective material on fingers and back of hand
- Unlined
- Soft finger knuckle protectors on the middle, ring and little fingers
- Soft base knuckle protection made of silicone for high wearing comfort
- Hand heel and hand edge reinforcement with Superfabric®
- Velcro fastener on the cuff
- Certified to DIN EN 13594:2015:  
„Protective gloves for motorcyclists“

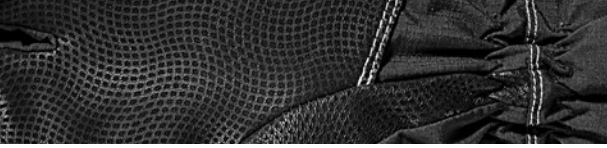

## GUARDO MONSOON

### Features MONSOON

#### Outer gloves / overgloves

If the weather is too cool or damp for summer gloves, the overgloves come into their own. Matching the size of the inner gloves perfectly, their breathable, wind and waterproof polyurethane membrane ensure a pleasant climate. The reinforced palm made of sheepskin provides a secure grip even on wet handlebars. The polyester lining as well as the width adjustment at the top of the glove enhance wearing comfort. Reflective material along with the wiper lip on the left index finger increase passive safety.

Palm: 100 % polyamid

Back: 100 % leather

Membrane: 100 % polyurethan

Lining: 100 % polyester

(Contains non-textile parts of animal origin)

- Match the size of the inner glove perfectly
- Palm made of sheepskin
- Back and cuff made of polyamide
- Breathable, wind and waterproof polyurethane membrane
- Polyester lining
- Elastic inset over the base knuckles
- Reflective material
- Elastic wrist
- Width adjustment with drawstring at the glove opening

#### Guardo WORLD (Adventure + Monsoon):

500-2075	size 7/S
500-2076	size 8/M
500-2077	size 9/L
500-2078	size 10/XL
500-2079	size 11/XXL
500-2080	size 12/3XL

#### Guardo ADVENTURE:

500-2081	size 7/S
500-2082	size 8/M
500-2083	size 9/L
500-2084	size 10/XL
500-2085	size 11/XXL
500-2086	size 12/3XL

#### Guardo MONSOON:

500-2087	size 7/S
500-2088	size 8/M
500-2089	size 9/L
500-2090	size 10/XL
500-2091	size 11/XXL
500-2092	size 12/3XL



# GUARDO RAMBLER GTX





Contains non-textile parts of animal origin.



**CERTIFIED**  
**DIN EN**  
**13594:2015**

With these Guardo Rambler GTX waterproof summer gloves, you'll be perfectly equipped on your summer excursion or motorcycle trip, even if it rains heavily.

GTX stands for the Gore Tex® material used. This guarantees absolute waterproofness and windproofness with maximum breathability. The short cuff made of soft 4-way stretch material with a large adjustment range is closed with a Velcro strap.

For a comfortable fit and fatigue-free riding, these gloves are pre-shaped, to match the natural hand position. Stretch areas on the fingers further promote relaxed finger positioning. The special external seams avert possible pressure points and provide ultimate sensitivity. Perforations on the palm and between the fingers noticeably increase breathability.

#### Safety

Both the palm guard and thumb guard are made of shock-absorbing SEESOFT™ Memory Foam material to effectively reduce impact energy when hit. It is embedded in highly abrasion-resistant TPU; ensuring that the glove glides across the asphalt should your hand come into contact with it. This abrasion resistance ensures a significantly reduced risk of injury.

#### MATERIAL

- GORE TEX® membrane with GORE GRIP® technology
- Extremely abrasion-resistant goatskin on the palm, partially perforated.
- Nyspan (82% Nylon, 18% Spandex) 4-way stretch fabric cuff with soft surface for comfort and freedom of movement
- Palm reinforcement and backhand in NUBUK quality
- Palm and thumb reinforcement SEESOFT®

515-1500	size 6/XS
515-1501	size 7/S
515-1502	size 8/M
515-1503	size 9/L
515-1504	size 10/XL
515-1505	size 11/XXL
515-1506	size 12/XXXL
515-1507	size 13/4XL



# GUARDO RAMBLER ICE GTX





**CERTIFIED**  
**DIN EN**  
**13594:2015**

With these waterproof Guardo Rambler Ice GTX 3-season gloves, you'll be perfectly equipped to meet any kind of weather conditions throughout the entire season. Technology and design have been developed to keep pace with your new Compañero Rambler rider suit.

GTX stands for the Gore Tex® material used. This guarantees absolute waterproofness and windproofness with maximum breathability. Developed specifically for gloves, Gore Grip technology uses an innovative layered construction to ensure a secure grip and precise fingertip feel at all times.

The long cuff, made of soft 4-way stretch material with a large adjustment range, is closed with a wide Velcro strap. An additional Velcro strap on the wrist prevents the glove from unintentionally slipping off.

For a comfortable fit and fatigue-free riding, these gloves are pre-shaped, matching the natural hand position. Stretch areas on the fingers further promote relaxed finger positioning.

**The material used on the index finger of the gloves has a visor wipe function. This helps wipe water or moisture from the visor for better visibility and a clear view.**

The high-quality lining of the gloves is made of 3M Thinsulate, rounding off the design.

#### Safety

The palm protector is made of shock-absorbing SEESOFT™ Memory Foam material, which effectively reduces impact energy when hit. It is embedded in highly abrasion-resistant TPU, ensuring that the glove glides across the asphalt should your hand come into contact with it. This abrasion resistance ensures a significantly reduced risk of injury.

#### MATERIALS

- GORE TEX® membrane with GORE GRIP® technology
- Extremely abrasion-resistant goatskin on the palm
- Nyspan (82% Nylon, 18% Spandex) 4-way stretch fabric cuff with soft surface for comfort and freedom of movement
- Palm reinforcement and back-hand in NUBUK quality
- Palm reinforcement SEESOFT®
- SUPERFABRIC® hard-shell protector
- 3M™ Thinsulate™ lining with 300 gr/m<sup>2</sup>

515-1510	size 6/XS
515-1511	size 7/S
515-1512	size 8/M
515-1513	size 9/L
515-1514	size 10/XL
515-1515	size 11/XXL
515-1516	size 12/XXXL
515-1517	size 13/4XL



# DESTINO

## ULTIMATE GTX

 TOURATECH

 REVIT!



**X**  
TOURATECH  
**NEW**  
**PART**

## Boots Touratech DESTINO Ultimate GTX

Tested in cold, wet, hot and dry weather, the Destino Ultimate GTX boots are made for adventure and action without forgetting a modern design and a cozy feeling. The waterproofness, freedom of movement, security and easy closure system will conquer you when putting your feet in for the first time. This is the combination of MX boots protections and the comfort of touring boots.

PROTECTION  
LEVEL 2



### GTX for Gore-Tex

The Destino Ultimate GTX boots are „Waterproof“ and keep your feet dry, due the Gore-Tex membrane.

### Comfort

Comfort and stability reunited in the Ortholite sole with a cozy, but responsive feeling. A Rev'it! SeeSoft technology at shin and tongue contributes to the overall protection and comfort.





### Dynamic Support Frame

Move fearless but without restrictions with the DSF – Dynamic Support Frame from Rev'it!. Protection and comfort are allies to prevent hyper extension of the muscles and tendons. When driving off-road, the calves are working a lot more than what we think: this is why these muscles are here supported by the DSF structure. Composed of 3 components: calf support, heel cup and stability frame.

CERTIFIED  
DIN EN  
13634:  
2017

### BOA System

Adjusting the boots at perfection is the dream of many riders. The BOA system will adjust itself for the perfect fit with its strategic tying points.

- Easy to close: turn the knob until it feels good.
- Easy to open: pull the knob forward and that's it.

### Security

The robust Superfabric and reflective 3M Scotchlite materials are not playing with your security. Be safe and visible in any situation.

To complete this list of countless benefits, the Destino Ultimate GTX boots are certified with the highest possible level: EN 13634:2017 Level 2.



**Vibram**

Using a Vibram Apex sole, the stability and the comfort are mixed up with durability and abrasion resistance, and allows the EVA midsole to absorb any shocks. The numerous spikes give the boots all the grip and stability you need to control your bike on every terrain.



500-3539	size 39	500-3544	size 44
500-3540	size 40	500-3545	size 45
500-3541	size 41	500-3546	size 46
500-3542	size 42	500-3547	size 47
500-3543	size 43		



TOURATECH

# DESTINO

TOURING 2 HDry®



## Destino Touring 2 HDry

The Touratech Destino Touring 2 HDry motorcycle boot combines maximum touring comfort with field-tested robustness. Due to this concept, it is absolutely made for the versatile demands of adventure riders who like to spice up their tours with gravel stages. Thanks to the refinement of the leather using advanced laminate technology, the latest generation has even better breathability and is waterproof at the same time.

## Leather laminate instead of membrane

The most important innovation in this all-rounder has to do with moisture protection. The Destino Touring 2 HDry is made using the name-giving, particularly high-quality HDry leather laminate. The advantages are obvious. Whereas the loose membrane in constructions with a liner is always subject to a certain amount of relative movement between the layers and the associated tensile and frictional forces, in the HDry leather laminate, the membrane and the outer material

form an inseparable unity. No water can penetrate between the leather and the membrane, there are no seams prone to defects, and the material stress is distinctly lower. In addition to the significantly higher robustness, this leather laminate upgrades the Destino Touring 2 HDry, above all, through noticeably improved breathability.



### Elaborate safety concept

This boot features an elaborate safety concept, with a robust sole, protectors on the shin and ankle, a double layer of leather on the heel and forefoot, as well as heat protection on the inside of the leg. The triple fixation, using solidly screwed buckles, guarantees a secure fit. Certification according to the latest CE standard guarantees the safe-guarding effect of the protectors.

### Comfortable and practical

Although it is equipped with robust protectors, the Touring 2 HDry is extremely comfortable to wear. In addition to the HDry leather laminate, the Air-Pump insole contributes to a pleasant climate inside the boot by means of effective air circulation. Being able to open the shaft wide makes pulling it on and off particularly easy. When closed, the Touring 2 HDry is extremely slim, so that wearing it under trousers works well. The shaft width can be adjusted individually by means of Velcro fasteners and adjustable locking buckles. Flex zones ensure good ankle mobility. A flat-cut forefoot area enables a good feel for the gear lever, while generous reinforcement of the area impacted when shifting gears protects the boot from abrasion. As a smart extra, the Touring 2 HDry, like all boots in the Destino family, has a pull out stainless steel cable to secure it against theft.

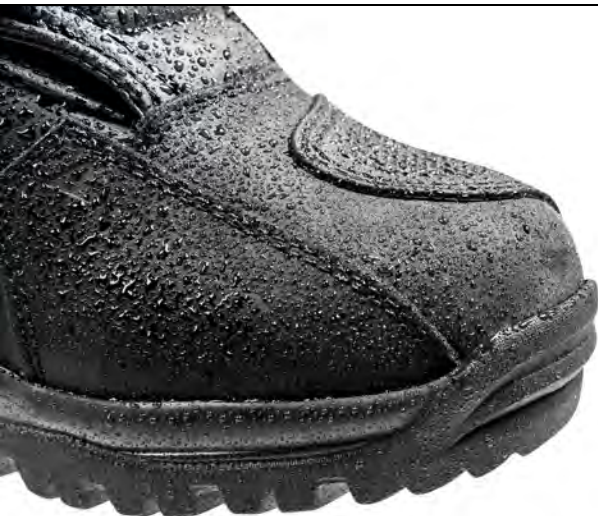

**HDry**  
WATERPROOF BREATHABLE®

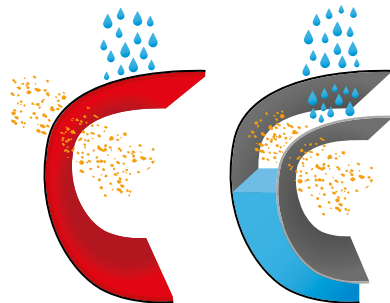

HDry®

Conventional



500-3438	size 38
500-3439	size 39
500-3440	size 40
500-3441	size 41
500-3442	size 42
500-3443	size 43
500-3444	size 44
500-3445	size 45
500-3446	size 46
500-3447	size 47
500-3448	size 48



- Waterproof and breathable thanks to state-of-the-art HDry leather laminate technology
- Certified according to CE standard
- High shaft with shin protector
- Ankle protectors and double leather layers on heel and forefoot
- Heat protection on the inside of the leg
- Soft and flexible shaft end prevents dirt getting in
- Adjustment of the shaft width by means of a robust Velcro surface with a big overlap and fastening buckles
- The 3-fold fixation and solidly screwed fasteners provide a secure fit
- Synthetic reinforcement on the outside of the leg
- Best possible compromise between high safety and maximum comfort
- Easy to pull on and off due to wide opening shaft
- High mobility due to flex zones in the ankle joint
- Reflective area in the rear flex zone
- Pleasantly light boot for excellent wearing comfort even on long tours
- „Air-Pump“ insole for air circulation
- Durable, oiled full-grain leather
- Oil and petrol resistant, particularly slip-resistant sole
- Flat-cut forefoot area, good feel for the gear lever
- Generous reinforcement of the area impacted when shifting gears
- Pull out stainless steel cable to secure the boots
- Slim fit boot for wearing under and over motorcycle trousers

**MADE FOR ADVENTURE.**

## ABUS Combiflex Pro 120 cm cable combination lock

Whether out on a Sunday drive or on a longer trip, bulky safety clothing, such as motorcycle boots or helmets, can be cumbersome when you are taking a break.

With this compact roll-back cable lock you can prevent opportunity thefts and stop people just walking off with your Destino boots or Aventuro helmet by securing them directly to your bike. You then have both hands free for cool drinks, your wallet, smartphone, or camera.

601-0017





## Leg bag Touratech

With the Touratech leg bag, you always have everything important at hand on your thigh! Size and design are ideally matched to the requirements of motorcycling - small enough not to get in the way and big enough for wallet, bunch of keys, and a thousand little things.

We have used only the highest quality materials, such as original YKK zippers, certified Cordura and branded buckles from Duraflex.

The elastic waist and leg straps ensure a perfect fit without readjustment - whether standing or sitting on the bike. The belt buckle is deliberately offset to the side so as not to press on the abdomen when sitting.

The zip of the lower main compartment has been moved to the side, allowing access even when seated on the bike without the contents spilling out onto the road. The divider zipper allows you to divide the bag. This way you can use the upper pocket as a classic belt bag and store the operating permits of your attachments in the separated pocket under the seat of your bike. The practical key clip and the small inner pockets round off the well thought-out feature list of the leg bag.

055-1051



## Ortema Ortho-Max Jacket protector jacket

Perfect all-round protection –  
by professionals, for professionals

- Extremely lightweight, breathable material
- Protectors EN 1621 (protection class / level 2)
- Removable upper arm and lower arm protector and back protector
- Back protector with continuous, flexible back plate
- Unsurpassed freedom of movement with perfect protection
- P1 Jacket back protector with state-of-the-art aeration and ventilation concept for optimal moisture dispersal
- Newly developed high impact foams ensure optimal energy absorption
- Combination of different materials for maximum flexibility and unrestricted movement
- Unaffected by colder temperatures

500-0355 size M: 165 - 175 cm, chest girth 95 - 100 cm

500-0358 size L: 175 - 185 cm, chest girth 100- 105 cm

500-0359 size XL: 185 - 195 cm, chest girth 105 - 110 cm

500-0357 size XXL: 185 - 195 cm, chest girth 110 - 115 cm

500-0354 size 3XL: 185 - 195 cm, chest girth 115 - 125 cm



## LUMBO-X Enduro lumbar belt

The Lumbo-X was developed along sports orthopaedic lines. As the Lumbo-X is made of a breathable mesh material it wicks up to 80% more moisture than traditional materials. The integral stabilisation belts can be adjusted individually to provide an exact fit and good purchase in any situation. The new ortho-tech protection system has been developed to dampen the impact of external forces and to protect the lumbar region. The coil chain follows the forward movement of the body but prevents the spine overstretching. Thus you have maximum freedom of movement together with a high level of protection. The Lumbo X can easily be combined with our Ortema P1 light back guard.

Lumbo-X Enduro: 24 cm high

500-0371 size M (-93 cm)

500-0372 size L (-103 cm)

500-0373 size XL (-113 cm)

500-0350 size XXL (-123 cm)

500-0349 size 3XL (+123 cm)





## Touratech Safety Vest

For many pilots the ultimate passive safety feature!

Standardised safety vests are ten a penny. But most of them won't do for anything more than use during breakdowns. The Touratech safety vest does not just offer highly reflective 3M Scotchlite components, but guarantees absolute comfort. The mesh fabric in the chest area allows air to pass through and prevents sweating - even in tropical climates. Thanks to the adjustable straps, the vest fits perfectly and will not flap even when you are travelling fast. Minimise your risk due to unobservant drivers! With the neon yellow Touratech safety vest, you are guaranteed to be seen! Compulsory in many European countries!



500-0290	S	500-0293	XL
500-0291	M	500-0294	XXL
500-0292	L	500-0295	3XL



## SealSkinz waterproof, breathable stockings

Is it possible to ride with cross boots through rain, mud and beastly weather for hours without getting wet feet?

Yes it is! The socks start where the rain trousers end. Thus water can even collect in the boots without you needing webbed feet.

The integral membrane between the socks' inner and outer fabrics reliably prevent water from getting into the socks. At the same time, vapour can still escape. The inner lining is made from merino wool which adds comfort and keeps you warm and dry.

Each pair of socks is checked to ensure it is fully waterproof before it is packed.

Material:

Inner: 38% merino wool, 38% acrylic, 22% polyester, 2% elastane

Membrane: hydrophilic membrane

Outer: 90% nylon, 10% elastane

070-1366	Size 39-42
070-1367	Size 43-46
070-1368	Size 47-49



### TOURATECH „Heavy Duty Riding Socks“ with DEO®DORANT Effect

Our „Heavy Duty Riding Socks“ are the ideal companions for long and strenuous tours! They stay pleasant to wear and remain a perfect fit even after lengthy use and are available as socks or knee socks according to your preference.

- The three-layer, profiled terrycloth absorbs vibrations and protects tPants sensitive areas of the feet susceptible to injuries and rubbing.
- The permeable material cladding the foot makes it easier for the skin to breathe and allows excess warmth and dampness to escape.
- The Lycra® content makes sure that the socks are a perfectly snug fit.
- Elastic tape level with the metatarsus prevents the socks from slipping even when moving vigorously. - The suitably profiled material at the heel (Y-shaped) fits perfectly and stabilises the foot.
- The socks are each anatomically matched to the shape of the left (L) and right (R) feet.

- The unique „Patent Rosso“ flat seam over the toes assures additional wearing comfort.
- The silver content of the Prolen® Siltex special yarn causes the socks to act like a deodorant.
- The antibacterial and fungicidal effect prevents the development of disagreeable odours while wearing the socks and guarantees maximum hygiene.
- The Swiss Sanitized® finish guarantees outstanding, machine-washable hygienic qualities – the socks have an antibacterial and fungicidal effect and block odours.

Composition: Cotton 80%, Prolen® Siltex with silver 17%, Lycra® 3%, with Sanitized® finish

Knee socks	Socks	size
200-0405	200-0401	38 - 40
200-0406	200-0402	41 - 43
200-0407	200-0403	44 - 46



200-0800



200-0801

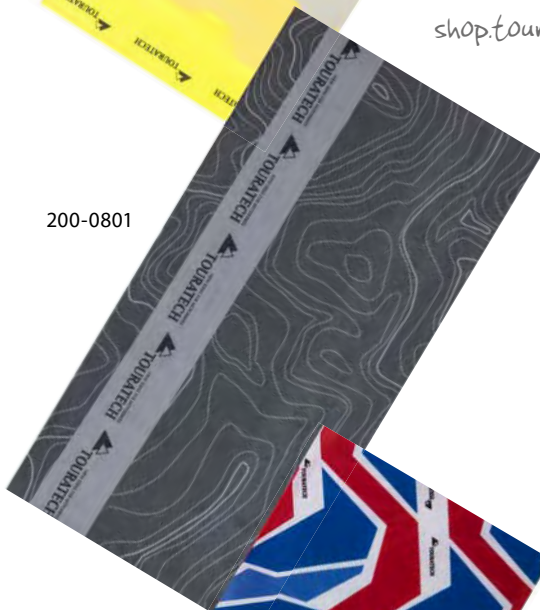

200-0802



## Multi-Functional Cloth

This is a multi-functional item of clothing for all activities, offering the highest degree of comfort and all-weather protection against wind, snow, sun, etc. The multi-functional-Cloth is made seamlessly from one piece, is very hard-wearing and shape-retaining.

Material: 100% Polyester (long-life)

Weight: 35 g

200-0800	PANORAMIC
200-0801	TERRAIN
200-0802	SPORTS
200-0200	TOURATECH

Discover more in  
our webshop:  
[shop.touratech.com](http://shop.touratech.com)





### TOURATECH balaclava-style hood, thin

- A classic, light balaclava hood.
- Its highly elastic material and ergonomic shape provide a perfect, close fit.
- Flat seams prevent pressure points and rubbing.
- Fabric is breathable and fast-drying.

It's perfect for warmer times of the year.

Size: One size fits all (head sizes: 53 - 62 cm)

Material: 95% viscose rayon / 5% Lycra spandex

Weight: 35 g

Colour: black

500-1724



### Original BUFF Cyclone neckerchief in Touratech design with Gore Windstopper

The classic for the colder seasons! In Touratech design – of course.

A double layer of original BUFF is complemented by the soft fleece with Gore Windstopper. You choose according to the temperature: fleece and Windstopper on top, or fleece at the bottom. Doesn't bulk up and will cope with any weather.

The Touratech BUFF Cyclone doesn't just look good between an all-in-one and a helmet.

600-0021



# ADVENTURE COUNTRY TRACKS



## — 5 YEARS OF ACT —

The Adventure Country Tracks project aims to create tours using the last remaining off-road tracks in Europe, and to preserve them in cooperation with local authorities and partners. This project is supported by numerous companies throughout the European motorcycle industry. Five exciting tracks have now been scouted and extensively documented.





STORY



# ACT GREECE

**The starting point of this unforgettable adventure is in Nafpaktos**, a beautiful town on the north coast of the Gulf of Corinth. The route first heads south to explore the mountains of the Peloponnese. From there, the journey continues in the north of the country. Highlights include crossing the mighty Pindos Mountains. The end of the track lies in the majestic Vikos Gorge on the southern slopes of the Tymfi Massif. As this track crosses the most remote regions of the Greek hinterland, it is important to be prepared for all possible situations. This is a medium/high difficulty adventure tour that can be very strenuous, depending on the weather and the condition of the track.



Expertize Level:	Advanced
Length:	920 km
Track Type:	Tarmac, gravel, rocks, mud
Off-Road Percentage:	45 %
Seasonality:	Middle May - middle October
Recommended Duration:	5 days
Accommodation:	Camping and small hotels
Language:	Greek & English



# ACT ITALY

**ACT Italy is a long journey into the central part of the Italian Apennines.** From the village of Bertinoro on the hills of Romagna, the route leads, in five stages, over 1160 kilometres of adventurous roads, to the stunning coast at the foot of the wild Abruzzo. This is a journey that begins in the forests of Emilia Romagna, passes through the green valleys of Umbria and the Marche, then through the fairy tale Val d'Orcia, to finally end in one of the wildest and most unspoilt regions of Italy.



Expertize Level:	Advanced
Length:	1160 km
Track Type:	Tarmac, gravel, rocks, mud (on wet season)
Off-Road Percentage:	45 %
Seasonality:	May / October (November)
Recommended Duration:	5 days
Accommodation:	Camping and small hotels
Language:	Italian & English





# ACT ROMANIA

**This five-day tour leads from the Maramures region on the Ukrainian border to the glacier lake Lac Balea in the Carpathians.** In addition to numerous easily manageable mountain passes, there are also challenging routes to be mastered through the forests of Transylvania. Gravelled trails lead far up into the mountains. The world-famous „Transalpina“ is as much part of the route, as the Urdele Pass and the „Strategica“, a military road from the time of the Second World War. In addition to ride pleasure there is also plenty of culture on this trip, in the form of historic towns such as picturesque Sighișoara.



Expertize Level:	Advanced
Length:	1370 km
Track Type:	Tarmac, gravel, rocks, mud
Off-Road Percentage:	45 %
Seasonality:	Middle May - end of October
Recommended Duration:	5 days
Accommodation:	Camping and small hotels
Language:	Romanian & English





## ACT PORTUGAL

**ACT Portugal offers a five-day, 1250-kilometre adventure route** that runs from Braça on the northern border to Tavira on the southern coast. This challenging track crosses green valleys, leads over densely forested mountains, and through golden fields. It runs along centuries-old trails and over the cobblestones of narrow village streets. ACT Portugal is a voyage of discovery into Portugal's rich history, into its rural culture and little-known hinterland.

Expertize Level:	Advanced
Length:	1250 km
Track Type:	Tarmac, gravel, rocks, mud (on wet season)
Off-Road Percentage:	45 %
Seasonality:	All year (some rain during winter)
Recommended Duration:	5 days
Accommodation:	Camping and small hotels
Language:	Portuguese, Spanish & English



# ACT PYRENEES

The latest ACT leads through one of the most fascinating mountain ranges in Europe: the Pyrenees. The starting point is Cap de Creus, the easternmost point of the Iberian Peninsula. From here, the track runs on both sides of the Spanish-French border to the Mirador Jaizkibel, high above the Bay of Biscay. In addition to smooth asphalt stages, this schedule also includes numerous off-road sections, some of which are tough. Highlights include the (former) smugglers' trails all around the dwarf state of Andorra in the heart of the mountains. On this unforgettable tour, numerous national parks are crossed whose landscapes, flora and fauna amaze even those who have travelled far.



Expertize Level:	Advanced
Length:	1160 km
Track Type:	Tarmac, gravel, rocks
Off-Road Percentage:	50 %
Seasonality:	All year (snow possible during winter)
Recommended Duration:	5 days
Accommodation:	Camping and small hotels
Language:	English, Spanish



## ACT PREPARATION

The Adventure Country Tracks have been selected so that their characteristics can be mastered by riders with average off-road riding skills on an adventure bike. The GPS data for the individual ACTs are available free of charge online. The website also provides basic information about the routes. Alternatively, you can become active yourself, load the route, scout it on the map or in Google Earth, determine the stages... and off you go.

### MOTORCYCLE AND EQUIPMENT

- ▶ Your motorcycle must be in perfect technical condition
- ▶ Tyres with off-road tread such as Metzeler Karoo 3
- ▶ Trail-proof luggage system (soft or aluminium panniers) required
- ▶ Solid support for the navigation system
- ▶ Accessories and settings must be tested extensively in advance

### TRACKS AND NAVIGATION

- ▶ All tracks are stored as GPX files for free download on the website
- ▶ All tracks are divided into five daily stages with alternative tracks for difficult passages, if required
- ▶ Study the tracks carefully with software such as Garmin BaseCamp before loading them onto your device, and adjust them if necessary
- ▶ A GPS device that supports track navigation is required
- ▶ Tracks are not routes along which you can rely on navigation announcements to guide you (depending on the device or app, there are exceptions)
- ▶ Practise following a track (only one line on the navigation system) beforehand

- ▶ Do not convert tracks into routes, otherwise the original routing may be lost
- ▶ Use maps, e.g. from OpenStreetMaps, for better coverage of the road and path network in remote areas
- ▶ The daily stages are simply recommendations. Everyone can ride at their own pace and take more or less time for each stage
- ▶ The condition of the tracks can change drastically depending on weather conditions

### RIDING SKILLS

- ▶ ACTs are not suitable for real beginners
- ▶ Learn safe motorcycle control in advance, e.g. through off-road/adventure training
- ▶ Riding with a passenger is not recommended

### DOS AND DON'TS

- ▶ Do not ride alone, but in a group so that you can call for help in an emergency
- ▶ Stay on the tracks. Do not ride cross-country
- ▶ Respect nature, animals and people, and ride responsibly so that the tracks remain legally passable for a long time
- ▶ Respect any route closures that may occur and look for a reasonable bypass yourself

### ACCOMMODATION & MEALS

- ▶ This is part of your individual trip planning before you start off
- ▶ There are recommendations on the ACT website for some of the tracks
- ▶ Eat & sleep local



TOURATECH Shirts | jackets

p. 756



Multi functional head cloth

p. 763



1 BACK ON TRACK!  
ADV  
MACHINE

# LIFE STYLE FASHION

TOURATECH Merch



p. 765





## T-Shirt „Nature“, green

Material 100% cotton

Men

200-0755	M
200-0756	L
200-0757	XL
200-0758	XXL



## T-Shirt "XXX Years" woman, gray

62 % cotton, 33 % polyester, 5 % elastane

200-2056	S
200-2057	M
200-2058	L
200-2059	XL
200-2060	XXL



## T-Shirt "Triangle View" woman, gray

62 % cotton, 33 % polyester, 5 % elastane

200-2061	S
200-2062	M
200-2063	L
200-2064	XL
200-2065	XXL

### Blouse "Touratech" Ladies - black

Material: 60% cotton, 40% polyester

- classical blouse
- two-colour Touratech embroidery on the front
- embroidery on collar and sleeve

#### Women

200-1645	S
200-1646	M
200-1647	L

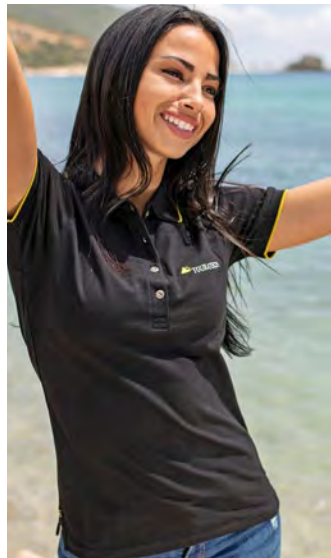
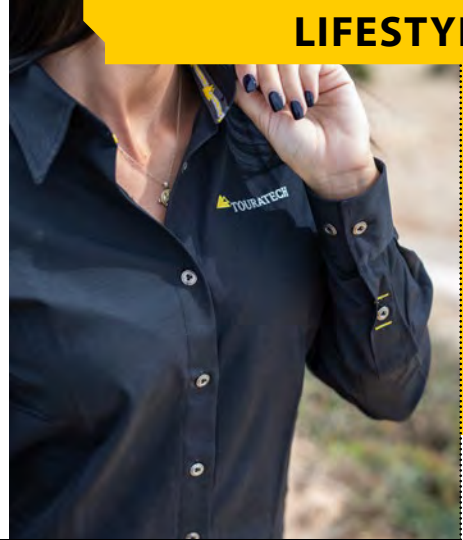

### Polo shirt "Touratech" - black

The authentic and classic „Touratech“ polo shirt is made of high quality cotton. Comfortable and lightweight, simply great to wear. And, of course, with embroidered Touratech logo on the breast. The seam is slitted for better wear comfort.

Material: 95% cotton, 5% elastane

- polo neck
- two-coloured Touratech embroidery on front
- slit on seam
- ladies cut

#### Women

200-1635	S
200-1636	M
200-1637	L

### T-Shirt "Touratech" - black

Material: 95% cotton, 5% elastane

#### Women

200-1600	XS
200-1601	S
200-1602	M
200-1603	L





## Hooded quilted jacket "Meran" / "Cortina"

The quilted jacket "Meran" is a light but warming jacket in a modern style for men/ women. Whether strolling through the city or sitting around the campfire in the evening, our hooded jacket "Meran" is the perfect leisure companion. The outer material, made of Taffeta, is particularly light, very robust and water-repellent. The PrimaLoft Thermoplume lining is a high-tech material with the most high-performance insulation effect on the market. Material: Outside 100% nylon | Inside 100% nylon | Lining 100% polyester

### Men/Meran

200-1980	XS
200-1981	S
200-1982	M
200-1983	L
200-1984	XL
200-1985	XXL
200-1986	3XL

### Women/Cortina

200-1970	XS
200-1971	S
200-1972	M
200-1973	L
200-1974	XL
200-1975	XXL



**T-Shirt „ADV Machine“, grey**

62 % cotton, 33 % polyester, 5 % elastane

200-2028	S
200-2029	M
200-2030	L
200-2031	XL
200-2032	XXL
200-2033	3XL
200-2034	4XL

**Longsleeve „ADV Machine“, black/grey**

62 % cotton, 33 % polyester, 5 % elastane

**Men**

200-2021	S
200-2022	M
200-2023	L
200-2024	XL
200-2025	XXL
200-2026	3XL
200-2027	4XL

**Polo-Shirt „Since 1990“, blue**

70 % cotton, 30 % polyester

200-2049	S
200-2050	M
200-2051	L
200-2052	XL
200-2053	XXL
200-2054	3XL
200-2055	4XL





### Longsleeve „30 Years“, grey

62 % cotton, 33 % polyester, 5 % elastane

Men

200-2007	S
200-2008	M
200-2009	L
200-2010	XL
200-2011	XXL
200-2012	3XL
200-2013	4XL



### Longsleeve „30 Years“, blue

62 % cotton, 33 % polyester, 5 % elastane

Men

200-2014	S
200-2015	M
200-2016	L
200-2017	XL
200-2018	XXL
200-2019	3XL
200-2020	4XL

### Longsleeve "Moto Rider" Kids, black

62 % cotton, 33 % polyester, 5 % elastane

200-2066	122/128
200-2067	134/140
200-2068	146/152
200-2069	158/164







**T-Shirt „Silhouette“, black**

62 % cotton, 33 % polyester, 5 % elastane

200-2043	M
200-2044	L
200-2045	XL
200-2046	XXL

**T-Shirt „North-South“, grey**

62 % cotton, 33 % polyester,  
5 % elastane

200-2036	M
200-2037	L
200-2038	XL
200-2039	XXL
200-2040	3XL
200-2041	4XL



**Sweat jacket "North-South",  
grey**

60 % cotton, 40 % polyester  
Men

200-2000	S
200-2001	M
200-2002	L
200-2003	XL
200-2004	XXL
200-2005	3XL
200-2006	4XL





## Shirt "Touratech" Mens - black

Material: 60% cotton, 40% polyester

- classical shirt
- discreet, two-colour Touratech embroidery on the front
- embroidery on collar and cuff
- breast pocket

### Men

200-1650	M
200-1651	L
200-1652	XL
200-1653	XXL
200-1654	3XL

## Shirt Woodpecker

100% Cotton, flannel

### Men

200-1230	S
200-1231	M
200-1232	L
200-1233	XL



## Original BUFF Cyclone neckerchief in Touratech design with Gore Windstopper

The classic for the colder seasons! In Touratech design - of course.

A double layer of original BUFF is complemented by the soft fleece with Gore Windstopper. You choose according to the temperature: fleece and Windstopper on top, or fleece at the bottom. Doesn't bulk up and will cope with any weather. The Touratech BUFF Cyclone doesn't just look good between an all-in-one and a helmet.

Material: 100% polyester

600-0021





200-0214



200-0213



200-0215



200-0217

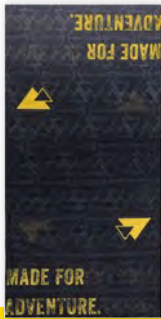

200-0216



200-0800

## Multi-Functional Cloth

This is a multi-functional item of clothing for all activities, offering the highest degree of comfort and all-weather protection against wind, snow, sun, etc. The multi-functional-Cloth is made seamlessly from one piece, is very hard-wearing and shape-retaining.

Material: 100% polyester

200-0200 TOURATECH	14,90 €
200-0211 ZEBRA	14,90 €
200-0213 *Frenzy* gelb	14,90 €
200-0214 *Frenzy* braun	14,90 €
200-0215 *Travel* grau meliert	14,90 €
200-0216 *Esential*	14,90 €
200-0217 *Stripes*	14,90 €
200-0800 *Panoramic*	14,90 €
200-0801 *Terrain*	14,90 €
200-0802 *Sports*	14,90 €



200-0211



200-0200

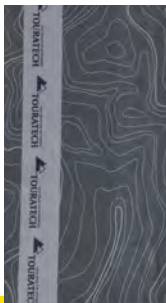

200-0801



200-0802





### Base Cap "Made for ADV"

65% Polyester, 32% Rayon, 3% Elastane

One Size

200-1991



### Beanie "North-South"

100% Acryl

200-1990

### Mug "Home of United Nations of Adventure"

070-0018 300 ml



### Sticker TOURATECH Outline-Cut black

100-0092 10,6 x 1,0 cm

### Sticker TOURATECH Outline-Cut white

100-0118 11 cm





### Touratech bottle opener for wall or case mounting

Who has never been confronted with this problem: you have reached the end of the leg of your motorcycle tour, the tent has been erected, you get the beer or lemonade bottle from your ZEGA case and - oh dear - no bottle opener. To make sure that you do not have to use a screwdriver in future, we have developed a bottle opener which can be mounted to any ZEGA case. Of course, the bottle opener can also be mounted to the wall of your garage, the couch table or any other stable surface.

- made of stainless, durable steel
- designed specifically for all ZEGA cases and ZEGA topcases
- opens any crown cap bottle
- mounting materials included in scope of delivery
- can be mounted anywhere

050-0782

### Lanyard Touratech - Coordinates

High-quality lanyard with 20 mm wide ribbon. Carabiner clip to attach keys.

200-0008

# TOURATECH

### Touratech Sticker „reflex“

Our Touratech logo in black on a contour cut sticker always looks good on your motorbike or on its panniers. The special film reflects in silver and white when light strikes it. This means the logo becomes a reflective surface in fog, rain and at night, greatly improving your visibility.

100-0502 12 x 2,6 cm



### Badge TOURATECH logo

Colour: black/yellow

100-0082 7 x 3 cm

100-0096 12 x 6,7 cm



### Badge ACT

Size: 10,0 x 6,4 cm

Colour: green

202-2002





NEW IDEAS FOR MOTORBIKES  
**TOURATECH**



Bike & Car Sets

p. 768



Handlebar mounts

p. 776





# NAVIGATION COMMUNICATION

Accessories

p. 778



Bluetooth  
Communication

p. 785





### Handlebar mount for Garmin Zumo XT, lockable

Like all Touratech handlebar mounts, we make this high-quality Zumo XT mount in Germany at our factory in the Black Forest.

Garmin Zumo XT handlebar mount features:

- This Touratech handlebar mount has been developed specially for Garmin Zumo XT devices.
- The motorbike cradle with power supply, which comes with the Zumo, is integrated into the mount.
- Laser-cut and CNC-shaped aluminium and stainless steel components for stability and precision.
- Holds and fixes the Garmin Zumo XT in position while protecting the power supply pins.
- The handlebar mount stabilises and secures the Garmin Zumo even in the roughest riding situations.

- Prevents the original Garmin motorbike cradle being opened accidentally or without your permission.
- It's quick and easy to insert the Garmin Zumo XT into the mount and remove it again.
- The Touratech Garmin Zumo XT handlebar mount is lockable.
- Clamp for 12 mm crossbars included.
- The handlebar mount can be used with our Touratech mounting adapters (available separately).
- Can be combined with the RAM ball mount system supplied with the Zumo.

The GPS Garmin Zumo XT and the Garmin motorbike cradle shown in the illustrations are not supplied with the Touratech mount.

065-1397



Garmin motorcycle bracket zumo XT, without cables and mounting adapter

065-1409



Carrying Case for Garmin zumo XT

065-1407



Power cable for Garmin zumo XT, motorcycle, with open cable-ends

065-1408



# Garmin zumo XT



## Garmin zumo XT incl. European maps

The rugged zumo XT all-terrain motorcycle navigator is built for adventure. Its ultrabright 5.5" display (14 cm) is glove-friendly and rain-resistant. It can withstand all kinds of weather, extreme temperatures and vibrations. Get adventurous routes with turn-by-turn directions for on-road navigation and topographic or BirdsEye Satellite Imagery for off-road guidance - no subscription needed. Rider alerts help prepare you for sharp curves and railroad crossings.

### FACT TAGS

- 5.5" ultrabright, glove-friendly display with crisp HD resolution in landscape or portrait mode; rain-resistant and built to military standard 810G for thermal and shock resistance
- Get spoken turn-by-turn directions through your connected helmet or headset plus preloaded off-road topographic maps with public land boundaries, 4x4 roads and more
- Access to BirdsEye Satellite Imagery with direct-to-device downloads and no annual subscription
- Garmin Adventurous Routing™ options find curvy or hilly roads for a fun and exciting riding experience
- Safety features include BLUETOOTH® hands-free calling, rider alerts, automatic incident notifications and pairing with a compatible inReach® satellite communicator (sold separately)

- Easily manage and review routes, tracks and waypoints across your navigator, smartphone and computer by using the Garmin Explore™ ecosystem
- Record your route by using the track recorder, and save or share it for future adventures
- Access live traffic and weather, share routes with other riders, and get phone notifications via the Garmin Drive™ app
- Stream music from your smartphone through the zumo XT navigator, or play MP3 files stored on your zumo
- Easily import and share GPX files using the Garmin Drive™ app

### Scope of delivery

- zumo XT
- Motorcycle mount incl. adapter plate
- Motorcycle connection cable
- Car mounting kit
- Car connection cable
- USB charge/sync cable
- Documentation

060-1480

060-1481 Bike&Car Set black

\*Bike & Car Sets incl. Touratech Handlebar mount



# Garmin TREAD

## Garmin Tread incl. Group Ride Tracker

### ROAM THE UNKNOWN

Spend your time ripping through the woods, not waiting on your friends. This rugged powersport GPS navigator keeps your groups in touch and on track.

#### RIDING RADIO FOR GROUP GETAWAYS

The included Group Ride Radio allows tracking for up to 20 riders with no cellular coverage needed. Plus, you can easily stay in communication with your Group Ride friends. Pair Tread with your helmet or headset (not included) enabled with BLUETOOTH® technology for hands-free communication.

#### OFF-ROAD RUGGEDNESS

Purpose-built for all-terrain use, Tread stands up to anything the elements can throw at it. It's IPX7-rated for water-resistance and built to U.S. military standard 810 for thermal and shock resistance.

#### HIGH-VISIBILITY DISPLAY

With its ultrabright 5.5" glove-friendly touchscreen, the Tread navigator is designed for easy viewing in bright sunlight or pitch dark. It can be mounted in portrait or landscape mode.

#### MAPS FOR OFF-ROAD

Tread features preloaded topographic and street maps of North America with U.S. Forest Service Roads and trails and Motor Vehicle Use Maps for full-sized 4x4s, side-by-side, ATVs and motorcycles.

#### KNOW YOUR BOUNDARIES

Access public land boundaries for national forests, Bureau of Land Management (BLM), wilderness areas and more. Also, see private land boundaries and landowner information for parcels greater than 4 acres.

#### SATELLITE IMAGERY

Download high-resolution BirdsEye Satellite Imagery directly via Wi-Fi® connectivity, with no annual subscription required.

Track through the outback — and stay in touch with your friends.

#### EASILY SYNC YOUR DEVICES

Use the Tread app2 to sync waypoints, tracks, routes and

collections across your devices, including your mobile device, computer and Tread navigator. Easily import and share GPX files, too.

#### MOUNTS WITH MUSCLE

The included powered mount and wiring harness with tube mount secure your Tread navigator to your powersport vehicle for riding over rough terrain.

#### ABC SENSORS

For tough-terrain guidance, built-in sensors include an altimeter, barometer, compass and pitch/roll gauges.

#### GO-ANYWHERE GUIDANCE

Get spoken turn-by-turn directions if you choose to take Tread with you when you head back to civilization and want on-road navigation. Includes driver alerts for sharp curves, red light/speed cameras4 and more.

Onboard tools for the ultimate off-road experience.

#### LIVE WEATHER

Weather ahead? Pair Tread with your compatible smartphone, and download the Tread app to access live weather, storm alerts, animated radar and more.

#### TRAVELING MUSIC

A built-in media player lets you easily control music loaded on your compatible smartphone on the navigator's display — and hear your tunes through your helmet or headset (sold separately) enabled with BLUETOOTH technology.

#### In the box:

- Tread
- Handlebar mount
- VHF antenna
- Antenna mount kit
- Tube mount kit
- High-current power cable
- Trim ring kit (blue, black, red and green)
- USB cable
- Documentation



#### Garmin Tread

060-1485

#### Garmin Tread Bike & Car Set incl. Group Ride Tracker

060-1487



## Garmin Group Ride Tracker

Pair with your compatible TREAD powersport or zumo® XT sat nav and stay connected with your friends with location sharing, pre-defined messaging, route tracking and more. Connects up to 20 riders, no mobile coverage needed.

060-1486



## Fitting adapter for Touratech handlebar mount for e.g. Garmin ZUMO XT / TREAD

This adaptor allows you to position your GPS device just where you want it in the motorbike cockpit. Suitable for all 12 mm diameter Touratech GPS adapters.

065-0526



## Adapter set for Garmin Group Ride Tracker to handlebar mount Garmin ZUMO XT

We have developed this clever adapter set so that the tracker also works without problems together with your "Touratech handlebar mount Garmin ZUMO XT". Can be used with the two enclosed clamps on all 12 mm struts or by means of optionally available RAM mount elements.

065-1399

## Handlebar mount for Garmin Tread lockable, black

The Touratech handlebar mount for the Tread is like a hand that closes securely around the Tread to hold and protect it. This even makes the navigation system suitable for off-road use. The diverse mounting options allow individual and ergonomic positioning on the vehicle.

Garmin Tread handlebar mount features:

- This Touratech handlebar mount has been developed specially for Garmin Tread devices.
- The motorbike cradle with power supply, which comes with the Tread, is integrated into the mount.
- Laser-cut and CNC-shaped aluminium and stainless steel components for stability and precision.
- Holds and fixes the Garmin Tread in position while protecting the power supply pins.

- Tracker unit is also fixed and secured.
- The handlebar mount stabilises and secures the Garmin Tread even in the roughest riding situations.
- Prevents the original Garmin motorbike cradle being opened accidentally or without your permission.
- It's quick and easy to insert the Garmin Tread into the mount and remove it again.
- The Touratech Garmin Tread handlebar mount is lockable.
- Clamp for 12 mm crossbars included.
- The handlebar mount can be used with our Touratech mounting adapters (available separately).
- Can be combined with the RAM ball mount system supplied with the Tread.



065-1398



## Handlebar mount for Garmin GPSMap 276Cx black

- This Touratech handlebar mount has been developed specially for Garmin GPSMap 276Cx devices
  - The motorbike cradle with power supply, which comes with the GPSMap, is integrated into the mount
  - Laser-cut and CNC-shaped aluminium and stainless steel components for stability and precision
  - Holds and fixes the Garmin GPSMap 276Cx in position while protecting the power supply pins
  - The handlebar mount stabilises and secures the GPSMap 276Cx even in the roughest riding situations
  - Touratech's tried-and-tested vibration damping protects the GPSMap 276Cx.
- Uses the unique new spring-mounted Touratech locking wings
  - Prevents the original Garmin motorbike cradle being opened accidentally or without your permission
  - It's quick and easy to insert the Garmin GPSMap 276Cx into the mount and remove it again
  - The Touratech Garmin GPSMap 276Cx handlebar mount is lockable
  - Clamp for 12 mm crossbars included
  - The handlebar mount can be used with our Touratech mounting adapters (available separately)
  - Can be combined with the RAM ball mount system supplied with the GPSMap

The Garmin GPSMap 276Cx and the Garmin motorbike cradle shown in the illustrations are not supplied with the Touratech mount.

065-0780

# Garmin GPSMAP 276Cx



The GPSMAP 276Cx is the ultimate successor to the GPSMAP 276C which, due to its key operation, high adaptability and reliability, was one of the most popular navigation devices for motorised outdoor and marine adventurers. Due to additional sensors, the device is technically up to date and provides comprehensive, accurate and reliable data. The high resolution 5" display is very easy to read, even in sunlight. For optimal navigation, various options, such as „Drive“ mode, TTS voice control and Curvy Roads were added. Bluetooth, ANT+ and WLAN, allow sensors, smart phones & Co. to be connected wirelessly. With the preinstalled Europe recreational map and BirdsEye support, the GPSMAP 276Cx is ready to use.

The Legendary All-Terrain Navigator is Back!

- Developed from the versatile GPSMAP 276C – features the same great customisability
- Adds more sensors - with GPS+GLONASS, Altimeter and 3D-Compass
- Large 5" sunlight readable WVGA display
- Optional advanced navigation – drive mode, TTS voice guidance, Curvy Roads etc.

- Fully connected through Bluetooth®, ANT+® and WiFi® - to stay in contact
- Preloaded Recreational Map of Europe and 1 year free BirdsEye Satellite subscription
- More mapping options available - including BlueChart® g2 and TOPO Map support

#### INCLUDED:

- Garmin GPSMAP 276Cx
- Lithium-ion rechargeable battery pack
- AMPS powered mounting bracket with marine bail mount
- USB cable
- AC charger
- Documentation

060-1455

Please also have a look at our favourable Bike&Car-Sets! For more information look under [www.touratech.com](http://www.touratech.com).



# TomTom Rider 550



## Handlebar mount for TomTom Rider 40 / 400 / 410 / 450 / 550

The Touratech handlebar mount for the TomTom Rider is like a hand that closes securely around the TomTom Rider 40/400 to hold and protect it. Our developers deployed their ingenuity and advanced technical expertise to design this lockable handlebar mount that locks and unlocks quickly and with ease. The TomTom Rider cradle with power supply is integrated into this Touratech motorbike mount. First of all, insert the TomTom Rider into the bracket

and it connects to the built-in TomTom Rider power supply. Then push the spring-mounted locking wings together and feel them click securely into place. Now you can lock the bracket via the integrated cylinder lock. The mount has been designed to allow the system to be switched on and off while the mount is locked. This handlebar mount can be ordered keyed alike with your existing Touratech accessories.

065-0321 black

065-0320 silver





## TomTom Rider 550 World, Lifetime global maps

Your next adventure is already waiting for you! The TomTom Rider 550 is the perfect companion! Its quad-core processor calculates the routes ultra-fast. Easily access the features of your smartphone via voice control with Siri and Google Now - including notifications via headset. Get the latest route and system updates on tour, even via hotel Wi-Fi - without cables and without a computer!

### HIGHLIGHTS:

- fast quad-core processor
- TomTom road trips
- smartphone notifications
- updates via wi-fi
- Google Now and Siri compatible
- glare-free 10.9 CM (4.3") capacitive touchscreen display
- surface can be operated with gloves on
- winding route navigation
- mountainous routes
- display in portrait and landscape format
- bluetooth® interface for headset and data exchange with other devices
- lifetime global maps (europe 43 countries installed; world maps for downloading)
- lifetime TomTom traffic
- lifetime radar cameras

Using the various options for route planning, you decide in advance how winding or mountainous your tour is to be. Select the region where you want to ride and TomTom will find the most exciting route for you. For a more representative view, simply change to the portrait format to see more bends on your route. The display can be operated with gloves without any difficulties. The premium real-time traffic information lets you circumvent congestion and closed roads. In addition, the Rider 550 provides global map coverage including lifetime map updates.

### SCOPE OF DELIVERY:

- TomTom Rider 550
- Motorcycle mounting with power connection
- Connecting cable for motorcycle onboard electronics
- USB cable for PC connection

**060-1470 Rider 550 World**

**060-1471 Rider 550 World Bike & Car Set, silver\***

**060-1472 Rider 550 World Bike & Car Set, black\***

**Please also have a look at our favourable Bike&Car-Sets! For more Information look under [www.touratech.com](http://www.touratech.com).**

**\*Bike & Car Sets incl. Touratech Handlebar mount**



NEW IDEAS FOR MOTORBIKES  
**TOURATECH**

# GPS brackets

- The motorbike cradle with power supply is integrated into the mount.
- Stabilises and secures the GPS even in the roughest riding situations.
- Touratech's tried-and-tested vibration damping.
- Prevents the motorbike cradle being opened without your permission.
- It's quick and easy to insert the Navigator into the mount and remove it again.
- The Touratech handlebar mount is lockable.
- Clamp for 12 mm crossbars included.
- Can be used with our Touratech mounting adapters or with the RAM mount system.



**Handlebar mount for Garmin ZUMO  
340 / 345 / 350 / 390 / 395**

065-0771 black



**Handlebar mounting  
Garmin Montana series/  
BMW Navigator Adventure**

065-0600 anodised natural aluminium

065-0599 anodised black

GPS devices shown in the illustrations are not supplied with the handlebar mount.



## Fitting adapter for Touratech handlebar mount

A really practical accessory for our Touratech handlebar brackets. This adaptor allows you to position your GPS device just where you want it in the motorbike cockpit. Suitable for all 12 mm diameter Touratech GPS adapters.

Installation is dependent upon the slanting angle of the fairing screen and the motorbike model.

065-0525



## Handlebar mounting V2.0 BMW Navigator IV, V and VI black

065-0561 black



## Handlebar mount for Garmin ZUMO 590 / 595

065-0791 black



## Handlebar mount for Garmin Zumo 396

065-1396 black



## GPS adapter for direct mounting to 12 mm struds, e.g. Zumo XT, Zumo 5xx, 276Cx, TomTom Rider 4xx series

Easy direct mounting of GPS mounts with "horizontal" (38 x 30 mm) hole spacing on 12 mm struts.

Fits e.g. Zumo XT, Zumo 5xx series, GPSmap 276Cx, as well as on TomTom Rider 5xx series.

Also can be used to mount a RAM mount base plate 01-068-0023-0.

All parts made of stainless steel

065-3001



WATER  
PROOF



FAST  
CHARGE



## RAM Mount inductive Quick-Grip smartphone holder

Inductive, Qi-enabled, waterproof, universal and one-handed: The active Quick Grip universal holder for smartphones is a highlight in the RAM MOUNTS range.

Built on the basis of the Quick Grip holding shells, it offers a solid spring-loaded extension that allows one-handed clamping of the devices. The upper and lower caps are rubberised for the right grip. Simply clamp it in place and your smartphone is safe, secure and visible in place. A tension spring secures the device in rough terrain. The charging function with 10 W maximum output is available for all compatible smartphones listed below. The holder is equipped with a pigtail connector that includes a switch to turn the charging function on and off. The USB connections are protected with silicone. You still need a holder suitable for the vehicle or intended use. A RAM Diamond Base with B-ball for connection to other holder components is included in the scope of delivery.

### Performance data:

Input Power: 5V-2A; 9V-1.67A

Output: 5W / 7.5W / 10W

Conversion efficiency: 85% max.

Transmission distance: 5-8 mm

Working Frequency: 110-205KHZ

Product Standard: WPC v.1.2.4

Qi Compatible QC2.0/QC3.0 power supply compatible

Height: 5.63 in / 14.30 cm - 6.63 in / 16.84 cm

Maximum width: 3.13 in / 7.95 cm

Maximum depth: 0.70 in / 1.78 cm

068-0238



## Smartphone Case for iPhone® 6, 6S, 7 and 8

All you need to use your iPhone® in your motorbike, in one value pack!

Your motorcycle deserves the best, and your iPhone need proper protection whilst on the move. We have combined all the items needed to provide a safe and unbeatable solution. With this pack you get everything to enjoy all the capabilities of your iPhone while riding.

### Included in the pack is:

- Weatherproof case for iPhone® 6, 6S, 7 and 8
- RAM-MOUNTS arm and handlebar base

Note: without charger cable

065-0215

iPhone not included.



## Handlebar bracket "iBracket"

Form and function unite.

In order to do justice to the design, feel and shape of the iPhone, the components have been reduced to the bare essentials. The shape and technical components are designed for maximum stability despite their delicate execution. UV-resistant silicone rings provide the intelligent 3D closure with the required tension. The iPhone is positioned in very stable, protective plastic corners. This precision closure form, developed to fit the iPhone exactly, integrates the device into the iBracket with no play at all. All functions of the iPhone remain readily accessible.

### The most important features in summary:

- 3D closure with one-handed operation
- CNC laser cut and CNC shaped stainless steel components
- Precision closure form, specially developed for the iPhone
- Touratech iBracket plastic corners with UV-resistant silicone rings
- Touratech vibration decoupling
- iBracket handlebarbracket 90° turnable
- iBracket handlebar bracket for bicycle riders
- iBracket handlebar bracket suitable for use with motorbikes

### Tips:

- Using our mounting adapters, this handlebar bracket can be fitted to almost any motorbike.
- The mounting bracket can also be used with common silicone protective cases for the iPhone.

iPhone not included.

### Apple

065-0439 iPhone 6/7/8

065-0446 iPhone 6+/7+/8+/XS Max

065-0452 iPhone X/XS/11

065-0455 iPhone 11

065-0456 iPhone 11 Pro Max

### Samsung

065-0453 Galaxy S8/S9

065-0454 Galaxy S8+/S9+

### iBracket Replacement Set- Siliconrings

065-0441 yellow

065-0442 black

065-0445 orange





065-1210

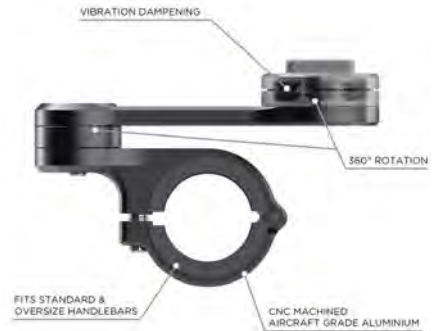

## Mobile phone holder set SP Connect Moto Bundle

The SP Connect™ MOTO BUNDLE lets you mount your smartphone to your motorbike in seconds. Fasten the MOTO MOUNT PRO to the handlebars of your motorcycle and you are ready to mount the SP Connect™ PHONE CASE by placing it on the mount and turning it 90° clockwise.

Your mobile phone is securely positioned right in the center of your vision, allowing you to navigate, access your playlists, read messages. Use the WEATHER COVER together with the Phone Case to protect your phone from rain and dirt as well as to provide additional shock resistance if necessary.

### Phone Case

- Slim, protective, functional
- Use of all ports and buttons
- 3-layer case construction for ultimate safeguarding
- Wireless charging possible

### Weather Cover

- Protects against rain, sweat, dust or mud
- Adds shock resistance to your phone

### Moto Mount Pro

- CNC machined from aircraft grade aluminum
- Portrait / Landscape Orientation
- 360° rotation
- Fits standard and oversize handlebars
- Stainless steel hardware

### iPhone 12 / 12 Pro

065-1210

### Samsung S21

065-1211

### SP Connect Universal Bundle

Size: 66 x 55 mm (2.6 x 2.17 Inch)

065-1212

## SP Connect Universal Phone Case Pouch

The SP Connect™ MOTO BUNDLE lets you mount your smartphone to your motorbike in seconds. Fasten the MOTO MOUNT PRO to the handlebars of your motorcycle and you are ready to mount the SP Connect™ PHONE CASE by placing it on the mount and turning it 90° clockwise.

Your mobile phone is securely positioned right in the center of your vision, allowing you to navigate, access your playlists, read messages. Use the WEATHER COVER together with the Phone Case to protect your phone from rain and dirt as well as to provide additional shock resistance if necessary.

### Universal Phone Case

- Universal pouch for smartphones in 2 sizes
- Protects against rain, sweat, dust and mud
- Use of all ports and buttons
- Usability of the touchscreen remains possible

065-1213	M	70 x 153 mm
065-1214	L	80 x 165 mm



## SP Connect Universal Interface

The adhesive UNIVERSAL INTERFACE attaches directly on to a phone case of your choice. It can also be used on other devices such as speakers, powerbanks, etc. You are able to use any SP Connect™ mount to securely attach your device to bicycles, cars, motorcycles, running armbands, golf trolleys, etc. with its patented twist to lock mechanism.

065-1215
----------



## SP Connect Moto Mount Pro

Attach your SP Connect™ Phone Case, or other SP Connect™ compatible devices to your motorbike with the MOTO MOUNT PRO. The mount is CNC milled out of aircraft grade aluminum and fits standard and oversized handlebars. You can mount it with the positioning arm or as a direct clamp mount - both versions allow 360° rotation to find the perfect position for your phone.

065-1216
----------





## SP Connect Ballhead Mount



Use the SP Connect™ BALLHEAD MOUNT to attach your SP Connect™ Phone Case or actioncam easily on any RAM® mount on your bike.

065-1218

## SP Connect Anti Vibration Module



The specially developed elastomer inlay dampens in all directions and stops up to 60% of vibrations.

065-1217

## SP Connect Universal Phone Clamp



With the SP Connect™ UNIVERSAL PHONE CLAMP, you can use just about any smartphone (see phone sizes below) on any SP Connect™ mount to securely attach your phone to bikes, cars, motorcycles, etc., using the patented "twist to lock" mechanism which is integrated in this clamp. Simply pull out the crown, screw it tight, and then push the crown back in to lock your phone in place. While remaining fully operable, your phone can now be attached to or detached from the mount in seconds.

- Easy and secure locking system
- Touchscreen operability and use of buttons remains possible
- Tool-free size adjustment from 58 - 85 mm

065-1219

## SP Connect Suction Mount



The SP Connect™ SUCTION MOUNT is the perfect solution for mounting your smartphone on to the windshield or any non-porous surface. It is a stable platform for your phone that enables vibration-free 360° positioning. Securely attach your phone in a second with its patented twist to lock mechanism.

- Quick and secure mounting
- Super-stable 360° positioning
- Vibration-free
- Easy mounting and removal

065-1220

## SP Connect Vent Mount Snap



The SP Connect™ VENT MOUNT SNAP attaches to your car's air vents in seconds and allows you to snap your phone onto it in seconds. The Vent Mount Snap is so small that you can easily take it with you when you travel.

065-1221

## GPS holder 360° Rotator The upgrade for your GPS holder!

This is simply screwed between the motorbike and the sat nav bracket and allows rotation of your sat nav through 360°.

The Rotator has been specially developed for all Touratech GPS holders, but it can also be used with the original Garmin holders. To fix it to your motorbike, use the model-specific Touratech GPS mounting adapter or standard RAM Mount mounting plate.



065-3000



## Ball joint adapter round tubing

You can use the attached screw M6x40 with washer and nylock as replacement for the original clamp-screw to prevent theft.

065-0040



## RAM mount ball for handlebar clamp

068-0022



## RAM Mount ball unit base plate

068-0023



## RAM ball unit plate

068-0001



## Adaptationer Ram Mount

For all ball joint adapters Ram Mount:

068-0230 short

068-0231 medium

068-0232 long



## RAM Mount Tough-Claw™

068-0112



## Ball joint-Adapter, lower ball with bow

You can screw on this ball attachment, for example, to a tubular handlebar, roll bar or tube and then fix your ball-joint adapter to it.

065-0044



## GPS handlebar bracket above the instruments

045-5415	BMW R 1250 GS ADV / R 1200 GS ADV (LC)	
040-0667	BMW R 1200 GS (-2012)	
082-5414	BMW F 850 GS/Adventure / F 750 GS	
632-5415	Yamaha Ténéré 700	
372-5415	KTM 790 Adventure / R	
440-5415	Harley-Davidson Pan America 1250	
373-5415	KTM 1290 SADV (2021-)	
371-5415	KTM 1190 / 1090 / 1050 ADV	black
371-5416	KTM 1190 / 1090 / 1050 ADV	orange
403-5415	Honda CRF 1100 L ADV Sports	



## GPS adapter over-cockpit

Many adventure bikes are factory-fitted with a wonderful bar that is used to attach navigation aids in the cockpit. It's just a shame that it's often so close to the windscreen. It means that there aren't many navigation systems that will fit easily behind the screen.

This gap can be increased and the angle set individually with our nav bracket. This creates more space and makes it easier to read the displays - and even bulky navs can be positioned easily.

046-0270	12 mm
402-5415	13 mm
044-0770	16 mm

## GPS handlebar bracket adapter

With our shapely mounting, it can be secured perfectly right next to the instruments without concealing them. When used in conjunction with a handlebar riser, your view to the GPS is not impaired at all, even with a tank bag fitted. Easy to fit, unobtrusive, and compatible with any of our navigation system mountings.



Model	part no.
BMW R 1200 GS (2013-) / R 1200 GS Adventure (2014-)	045-5410
BMW F 850 GS / F 750 GS	048-0210
BMW F 800 GS / F 800 GS Adventure / F 700 GS / F 650 GS(Twin)	082-5410
Honda CRF 1000 L Africa Twin / CRF 1000 L ADV Sports / CRF 1100 L Africa Twin / CRF 1100 L ADV Sports	402-5410
Yamaha Tenere 700	632-5410





Ergonomische Form

MEHR VOLUMEN, BASS UND KLARHEIT



## Headset Sena 50R

WE SET A NEW STANDARD

The 50R combines Sena's most advanced mesh technology to date and a premium SOUND BY Harman Kardon sound experience in an unobtrusive, low-profile yet rugged design. The 50R was tested during the 2020 Int. GS Trophy and proved its worth to over 100 participants across the expanse of New Zealand. With its powerful audio capabilities, rugged housing and innovative technology, the 50R's form and function set a new standard in motorcycle communications.

### MORE CONTROL WITH THE SENA MOTORCYCLES APP

The new Sena Motorcycles app gives users the ability to visually configure their 50R's settings.

### TECHNICAL DATA

Main module: 97 mm x 48 mm x 27 mm (3.8 in x 1.8 in x 1.0 in)

Weight: main module 65 g

- Operating temperature: -10°C 55°C
- Charging temperature: 0°C 45°C
- Mesh Intercom™ technology

- Range:
  - Bluetooth intercom: up to 2 km in open space
  - Mesh intercom: up to 2 km\* in open area
  - \* Can be extended up to 8 km when at least 6 drivers are connected
- Supports up to:
  - Bluetooth Intercom: 4 drivers
  - Open Mesh Intercom: unlimited number of riders
  - Group Mesh Intercom: 24 riders
- Channel support:
  - Open Mesh Intercom: 9 channels

- Talk time:
  - Bluetooth Intercom: up to 13 hours
  - Mesh Intercom: up to 8 hours
- Charging time: 1 hour
- Type: Lithium Polymer

### Certifications

- CE, FCC, IC

065-1011

065-1012 Duo Set





## Headset Sena 30K Bluetooth Mesh-Net-work system

Sena's adaptive mesh networking technology for the 30K ensures seamless communication within your group, even if one driver moves out of range. With its additional connections and mesh networking technology, the 30K offers next generation communication. Simply press the button on top of the 30K to turn on public mode, and you will be automatically and instantaneously connected to a virtually limitless amount of 30K users within a mile range. Intercom connections are also now more stable than ever with Sena's new Mesh Intercom™ technology. When one of a group's riders goes out of range, the rest of the group remains seamlessly connected while the 30K still intelligently searches for the lost connection and reconnects automatically once back in range. No longer will you have to worry about losing half of your group due to a Bluetooth chain linked connection of the past. With private mode you can invite and communicate with up to 16 riders at a range of up to 2.0 km (1.2 miles), while an endless amount of Guests can join to listen in as well. When riding with 5 or more riders, the Mesh Intercom will intelligently keep the group connected at a range of up to 8 km (5 miles).

### HIGHLIGHTS

- Connection from rider to rider, up to a distance of 2000 metres in open terrain
- Group intercom for up to 16 users
- Bluetooth 4.1 works with all smartphones, mobiles and sat navs
- Up to 13 hours of talk time
- Hands-free calls for all Bluetooth mobiles, smartphones and iPhone
- FM and VHF radio receiver with RDS AF (Radio Data System Alternate Frequencies)
- Updatable software

### GENERAL SPECS

#### Dimensions:

- Main module: 102 mm x 56 mm x 27 mm ( 4.0 in x 2.2 in x 1.1 in)
- Speaker: driver unit 40 mm – thickness 6.5 mm
- Boom microphone: length 190 mm

Weight: 61 g (2.15 oz)

#### Sena 30K

065-0986

#### Sena 30K (Duo-Set)

065-0987



## Headset Sena 20S EVO Bluetooth system

The SENA 20S EVO is the latest in high-end stereo Bluetooth headsets for motorcyclists. Suitable for use in any helmet, it offers an increased intercom distance and voice prompts for all key functions - including speed-dial for up to three favourites saved in the headset. The Universal Intercom protocol allows it to communicate with headsets by other manufacturers. Further enhanced HD audio sound quality keeps the rider in touch with up to nine riding companions and even offers group intercom. An integrated FM Radio with RDS can pre-set ten stations, adding to the joys of the journey, while Music Sharing allows riders to share music and navigation instructions wirelessly via Bluetooth with companions or a passenger.

### HIGHLIGHTS

- Connection from rider to rider, up to a distance of 2400 metres. Increases depending on the number of participants.
- Group intercom for up to eight users
- Nine-way intercom
- Bluetooth 4.1 works with all smartphones, mobiles and sat navs

- Up to 12 hours of talk time and 9 days of standby time
- Hands-free calls for all Bluetooth mobiles, smartphones and iPhone
- FM and VHF radio receiver with RDS AF (Radio Data System Alternate Frequencies)
- Updatable software

### GENERAL SPECS

#### Dimensions:

- Main module: 94.7 mm x 48.3 mm x 25.5 mm (3.7 in x 1.9 in x 1.0 in)
- Speaker: driver unit 36 mm - thickness 6.5 mm
- Boom microphone: length 190 mm
- Wire between speakers: length 555 mm

Weight: 60 g (2.11 oz)

### Sena 20S EVO

065-0984

### Sena 20S EVO (Duo-Set)

065-0985



## Sena 10S Bluetooth Communication System

The SENA 10S is the latest in high-end stereo Bluetooth headsets for motorcyclists. Suitable for use in any helmet, it offers an increased intercom distance and voice prompts for all key functions - including speed-dial for up to three favourites saved in the headset. The Universal Intercom protocol allows it to communicate with headsets by other manufacturers. Further enhanced HD audio sound quality keeps the rider in touch with up to four riding companions and even offers group intercom. An integrated FM Radio with RDS can pre-set ten stations, adding to the joys of the journey, while Music Sharing allows riders to share music and navigation instructions wirelessly via Bluetooth with companions or a passenger.



### HIGHLIGHTS

- Connection from rider to rider, up to a distance of 2000 metres in open terrain
- Group intercom for up to four users
- Four-way intercom
- Bluetooth 4.1 works with all smartphones, mobiles and sat navs
- Up to 12 hours of talk time and 9 days of standby time
- Hands-free calls for all Bluetooth mobiles, smartphones and iPhone
- FM and VHF radio receiver with RDS AF (Radio Data System Alternate Frequencies)
- Updatable software

### GENERAL SPECS

Dimensions:

- Main module: 85 mm x 57 mm x 27 mm (3.4 in x 2.2 in x 1.1 in)
- Speaker: driver unit 36 mm – thickness 6.5 mm
- Boom microphone length: 183 mm

Weight: 57 g (2 oz)

**Sena 10S**

**065-0962**

**Sena 10S (Duo-Set)**

**065-0963**



### Headset Sena 55

Born from the legendary Sena SMH5, the Sena 55 is the next-generation of feature-rich and value-packed intercoms from Sena. With this easy to use and accessible unit, you get High Definition in-helmet speakers, High Definition two-way intercom, and integrated LCD screen; all the features you need at an amazing value. The 55 with Bluetooth® 5 keeps you connected to your riding companion or passenger with HD Sound quality, music sharing, and audio equalizer profiles built right in. With even more features packed in, it also lets you answer phone calls hands-free, listen to FM Radio, and hear your GPS prompts. The 55 features a Helmet Clamp Kit and Boom Microphone. The Jog Dial makes for an intuitive user interface that is much easier to control while riding, which means you'll ride safer.

**Dimensions:**

- Speaker Driver Unit: 40 mm – thickness 7.2 mm
- Main module: 76 mm x 48 mm x 30 mm (3.0 in x 1.9 in x 1.2 in)
- Wire between Speakers: length 700 mm
- Wired boom microphone: length 183 mm
- Weight: main module - 48 g (1.69 oz)
- Operating temperature: -10°C ~ 55°C (14°F ~ 131°F)



**Bluetooth 5**

- Headset Profile (HSP)
- Hands-Free Profile (HFP)
- Advanced Audio Distribution Profile (A2DP)
- Audio Video Remote Control Profile (AVRCP)

**Intercom**

- Working Distance: Up to 700 m (0.4 mi) in open terrain
- Supports up to 2 riders

**Audio**

- Noise Cancellation: Advanced Noise Control™
- Codec: Built-in SBC Codec
- FM Radio: Radio frequency specifications: 76 ~ 108MHz
- HD Voice enabled for high-quality phone call audio

**Battery**

- Talk time: 7 hours
- Charging time: 1.5 hours
- Type: Lithium Polymer Battery

Certificates CE, FCC, IC

**065-0997**

**065-0998 Duo Set**

### Headset Sena 3S Bluetooth communication system and hands-free kit

The 3S is a stereo headset with Bluetooth intercom, which has been specially developed for motorcyclists. With the 3S, you can use the hands-free function on your Bluetooth mobile phone to listen to music in stereo and converse with a passenger or other drivers in full duplex.

Thanks to Bluetooth 3.0 and advanced digital signal processing technology, the 3S offers the best sound

quality in its class for incoming and outgoing audio signals. Easy-access and intuitive two-button operation also help make the 3S a perfect companion for motorcyclists.

**065-0969**





## Headset Schubert SC10U for Touratech Aventuro Mod and Schubert C3/C3 Pro/E1

The SC10U is a Bluetooth 4.1 stereo headset with Bluetooth intercom for motorbike riders. It is designed to fit perfectly on specialist helmets like the Touratech Aventuro Mod, the Schubert C3/C3 Pro and E1, and is completely integrated in these helmets.

Listening to music in stereo and conversing in full duplex with a passenger or with other riders. Thanks to Bluetooth 4.1 and advanced digital signal processing technology, the 10U delivers the best sound quality in its class for incoming and outgoing audio signals. The readily accessible and intuitive 2-button controls also help to make this into the perfect companion for motorbike riders.

Pair with any Bluetooth® device within a 2 km range

Activate the integrated programmable FM tuner or pair it with your Bluetooth®-enabled MP3 player for hours of riding with your favorite soundtrack. Enjoy fewer dropped signals with a more robust and reliable wireless protocol that enables you to have four-way conversations with your riding companions within a 2 km range. With up to 10 hours of talk time, you'll likely run out of gas before your SC10U runs out of juice.

### HIGHLIGHTS

- Connection from rider to rider, up to a distance of 1600 metres. Increases depending on the number of participants.
- Conference-call connection for up to 4 participants
- Separate point-to-point connections for up to 4 participants
- Bluetooth 4.1 functions with all smartphones, mobiles and navigation devices,...
- Up to 10 hours of voice time / Standby up to 8 days
- Hands-free telephone unit for all Bluetooth mobile phones, SmartPhones, iPhone
- FM and USW radio reception
- Control using voice commands
- Software can be updated

### GENERAL SPECS

- Dimensions: -Microphone with control unit: 77 mm x 68 mm x 58 mm (3.0 in x 2.7 in x 2.3 in)
- Weight: 88 g (3.10 oz) g

**065-0978**



## Headset with integrated Actioncam SENA 10C EVO

Combining Sena's leading Bluetooth communications platform with an integrated 4K camera, the 10C EVO allows for easy rider communication and video recording. The 10C EVO's features include:

- A sleek, compact design
- A brand-new camera platform, capturing video quality at 4K/30FPS
- Video tagging
- Smart Audio Mix™
- Four-way Bluetooth intercom up to 1.6 km (1 mile)
- Bluetooth connectivity to take calls, listen to music and hear turn-by-turn GPS directions

### Product Specs General

- Operating Temperature: -10°C - 55°C (14°F - 131°F)
- Dimensions:
- Main module: 95 mm x 59 mm x 31 mm (3.7 in x 2.3 in x 1.2 in)
- Speaker driver unit: 36 mm – thickness 6.5 mm
- Boom microphone: length 190 mm
- Wire between speakers: length 555 mm
- Weight: Module: 90 g (3.17 oz)

### Intercom

- Working Distance: Up to 1.6 kilometers (1.0 mile) in open terrain
- Supports up to 4 riders

### Audio

- Noise Cancellation: Advanced Noise Control™
- Codec: Built-in SBC Codec
- FM Radio

- Radio frequency specifications: 76 ~ 108MHz
- 10 preset station memory
- HD Voice enabled for high-quality phone call audio

### Optical

- Field of view: 125 degrees
- Aperture f/2.4
- Lens rotation: 30 degrees

### Video

- 2160p: 30fps (Ultra HD)
- 1440p: 30fps (Quad HD)
- 1080p: 60fps (Full HD)
- 1080p: 30fps (Full HD)
- Video recording time: 1.5 hours
- Video file format: MP4 (H.264)
- Max video bit rate: 60 Mb/s (4K)

### Photo

- 12MP (4:3)
- Burst shot: 8 pics per second

### Time-Lapse Mode

- Single shot every 1 sec or every 2, 5 or 10 secs

### Battery

- Talk time: 20 hours
- Charging Time: 2.5 hours
- Built-in 1,200 mAh Lithium polymer battery

### External memory

MicroSD card (U3 or higher) up to 128 GB (not included in package)

Certificates CE, FCC, IC

065-0994





### Adapter Sena +MESH Bluetooth to Mesh Intercom

With +Mesh, any Sena headset can now enjoy the benefits of Mesh technology when using the intercom. The +Mesh wireless adapter for Sena headsets allows for seamless communication with other Sena headsets built with Mesh Intercom, rather than connecting over Bluetooth, with a range up to 800 meters (0.5 miles). The easy-to-use +Mesh adapter will turn any headset into a more advanced and flexible communication device with the simple push of a button. Mesh-network technology will instantly connect you to a virtually limitless amount of users and provides a more stable connection by intelligently searching for lost intercom connections and automatically reconnecting them once back within range, while the rest of the group stays together.

#### Product Specs General

- Operating Temperature: -10°C - 55°C (14°F - 131°F)
- Dimension: 45 mm x 187 mm x 26 mm (1.8 in x 7.4 in x 1.0 in)
- Weight: 60 g ( 2.1 oz)
- Bluetooth 4.1
- Connection Distance: 10 meters

#### Intercom

- Mesh Intercom™ Technology : Open communication (public mode)
- Mesh Intercom™ Distance: 800 meters (880 yards)
- Battery Talk Time: up to 13 hours
- Charging Time: 2 hours
- Certificates CE, FCC, IC

065-0989



### HD Speaker Set Sena

#### A new audio experience

Take your Sena headset to a whole new level of audio. Sena's premium HD speakers offer a significant increase in volume, bass and clarity, dramatically improving the sound experience.

065-0999 50S / 30K / 20S / 20S Evo

065-1000 5S / 10C Pro / 10C Evo

065-1006 50R / 10S / 10R





## Headset Sena 50S

Mesh 2.0 features a robust connection, enhancing communication. 6 people can speak at the same time while a limitless number of participants listen in. Communication response time has been improved by 25% from the previous iteration. Mesh 2.0 also introduces brand new ways to connect with other riders on the road. With Multi-Channel Open Mesh Intercom, you have 9 channels available, an industry first! Switch between channels to converse with different groups participating in Mesh communication. Or, switch over to Group Mesh to create a private group and have up to 24 participants.

### General

Dimensions:  
 Main module: 102 mm x 56 mm x 27 mm  
 (4.0 in x 2.2 in x 1.1 in)  
 Speaker Driver Unit: 40 mm – thickness - 7.2 mm  
 Boom microphone: length - 190 mm  
 Wire between speakers: length - 555 mm  
 Weight: main module - 61 g (2.15 oz)  
 Operating temperature: -10°C - 55°C (14°F - 131°F)

### Mesh Network

Mesh 2.0 Intercom™ Technology

### Bluetooth

Bluetooth 5.0  
 Headset Profile (HSP)  
 Hands-Free Profile (HFP)  
 Advanced Audio Distribution Profile (A2DP)  
 Audio Video Remote Control Profile (AVRCP)

### Intercom

Working Distance:  
 Bluetooth Intercom: up to 2.0 km (1.2 miles) in open terrain  
 Mesh Intercom: up to 2.0 km (1.2 miles)\* in open terrain  
 \*Can extend up to 8.0 km (5.0 miles) between a minimum of 6 riders  
 Supports up to:  
 Bluetooth Intercom: 4 riders  
 Mesh Intercom (Open Mesh): virtually limitless  
 Mesh Intercom (Group Mesh): 24 riders

### Audio

Noise Cancellation: Advanced Noise Control™  
 Codec: Built-in SBC Codec  
 FM Radio:  
 Radio frequency specifications: 76 ~ 108MHz  
 10 preset station memory

### Battery

Talk time:  
 Bluetooth intercom: 14 hours  
 Mesh intercom: 9 hours  
 Charging time: 1 hour  
 Quick Charge: 20 minutes of charging equals 6 hours  
 Bluetooth intercom or 3.5 hours Mesh Intercom  
 Lithium Polymer Battery

### Certificates

CE, FCC, IC

065-1009

065-1010 Duo Set



## Headset Sena SF4

The SF4 is the perfect device for riding with friends by providing connectivity for small groups. The SF4's 4-way intercom has a range over 1.2 kilometers (.80 miles) so you can easily stay connected with your group in open terrain. The SF4 also uses smartphone connectivity, allowing for music streaming, taking and making phone calls, and hearing turn-by-turn GPS directions. Most importantly, riders can listen to music and use the intercom simultaneously, using the Audio Overlay™ feature. Plus, with the Quick Charging capabilities, you will be ready to start your ride in no time.

### Product Specs General

- Talk time: 13 hours
- Operating temperature: -10°C ~ 55°C (14°F ~ 131°F)
- Dimensions:
- Speaker Driver Unit: 32 mm – thickness 10 mm
- Main Module: 73.3 mm x 38.7 mm x 16.6 mm (2.9 in x 1.5 in x 0.7 in)
- Wired Boom Microphone: length 183 mm
- Wire between Speakers: length 590 mm
- Weight: main module - 35 g (1.23 oz)

### Bluetooth

- Bluetooth 4.1
- Headset Profile (HSP)

- Hands-Free Profile (HFP)
- Advanced Audio Distribution Profile (A2DP)
- Audio Video Remote Control Profile (AVRCP)

### Audio

- Noise Cancellation: Advanced Noise Control™
- Codec: Built-in SBC Codec
- FM Radio:
- Radio frequency specifications: 76 ~ 108MHz

HD Voice enabled for high-quality phone call audio

### Intercom

- Working Distance: Up to 1.2 km (0.8 mi) in open terrain
- Supports up to 4 riders

### Battery

- Charging time: 1.5 hours
- Quick Charge: 30 minutes of charging equals 4 hours intercom
- Type: Lithium Polymer Battery

Certificates CE, FCC, IC

065-0992

065-0993 Duo Set



## Headset Sena SF2

Built for communicating with another rider, the SF2 Bluetooth Communication System provides 2-way intercom communication up to 800 m (880 yards) in open terrain. The SF2 also lets riders enjoy smartphone connectivity allowing for music streaming, taking and making phone calls, and hearing turn-by-turn GPS directions. Plus, with the Audio Overlay™ feature, riders can simultaneously listen to music and use the intercom so you are never disconnected. Plus, with the Quick Charging capabilities, you will be ready to start your ride in no time.

### Product Specs General

Talk time: 13 hours  
 Operating temperature: -10°C ~ 55°C (14°F ~ 131°F)  
 Dimensions:  
 HD Speaker Driver Unit: 40 mm – thickness 11.6 mm  
 Standard Speaker Driver Unit:  
 32 mm – thickness 4.5 mm  
 Main Module: 73.3 mm x 38.7 mm x 16.6 mm  
 (2.9 in x 1.5 in x 0.7 in)  
 Wired Boom Microphone: length 183 mm  
 Wire between Speakers: length 590 mm  
 Weight: main module - 35 g (1.23 oz)

### Bluetooth 4.1

Headset Profile (HSP)  
 Hands-Free Profile (HFP)  
 Advanced Audio Distribution Profile (A2DP)  
 Audio Video Remote Control Profile (AVRCP)

### Audio

Noise Cancellation: Advanced Noise Control™  
 Codec: Built-in SBC Codec  
 FM Radio:  
 Radio frequency specifications: 76 ~ 108MHz  
 HD Voice enabled for high-quality phone call audio

### Intercom

Working Distance: Up to 800 m (880 yds) in open terrain  
 Supports up to 2 riders

### Battery

Charging time: 1.5 hours  
 Quick Charge: 30 minutes of charging equals 4 hours intercom  
 Type: Lithium Polymer Battery  
 Certificates CE, FCC, IC

065-0990

065-0991 Duo Set



NEW IDEAS FOR MOTORBIKES

**TOURATECH**



Luggage

p. 798



Accessories

p. 800





# OUTDOOR

Camping

p. 802





## TOURATECH ADVENTURE 2 rucksack

We have developed a rucksack that meets almost every requirement an adventure traveller could have! On a motorbike, bicycle or hiking - it even looks good in the city! There's plenty of space in the „Touratech Adventure“ for everything you could possibly need when you're on the go. All divided into various compartments - but with no loss of clarity. The special shape, innovative interior and first-class Airstripes carrying system guarantee the perfect fit in any situation. The rucksack for bikers!

### New features:

- Extended, rollable compression straps function as helmet holders
- Additional inner pockets
- Extended breathable shoulder straps
- Rain cover in neon yellow with a reflective TOURATECH logo keeps the contents absolutely dry even after long periods of rain
- Zipper slider with a press stud prevents it from opening by itself
- Spacious front pocket holds all the important things close at hand, including keys
- Side compression straps adjust the volume so the

weight can be placed as close as possible to the body or additional equipment can be attached

- Removable mat stabilises the rucksack and is a comfortable seat when enjoying a snack at the top
- Large 3M reflective surfaces provide greater safety in the rain and dark
- Elastic drawstring on the top for the easy attachment of light objects
- Mesh outer pockets keep drinking bottles, maps and a hat within reach
- Slide compartment for hydration system in the main compartment; with tube holes
- Separate base compartment with detachable base keeps the contents in place
- Quick release fasteners on the straps make it easy to put on - even over a jacket
- The Airstripes back system for the perfect wear comfort

Capacity: approx. 30 litres

Material: 210d Nylon, Super-Polytex 600d Polyester

055-0260 yellow/black

055-0261 orange/black

055-0263 brown/beige



Rain Cover









## Rucksack Touratech ZEGApack 2

A complete leisure backpack specifically for motorcyclists, TOURATECH has created the solution with the ZEGApack2!

### Further practical details:

- carrier system can be covered completely via zipper cover
- Side straps for mounting to all ZEGA and BMW Adventure cases
- Loops for mounting the optional helmet net
- rain cover in bright yellow with reflecting TOURATECH logo and additional safety clips, keeps the rucksack contents absolutely dry, even during longer rain
- Zipper slider with a press stud prevents it from opening by itself
- Spacious front pocket holds all the important things close at hand, including keys
- Side compression straps adjust the volume so the weight can be placed as close as possible to the body or additional equipment can be attached
- Large 3M reflective surfaces provide greater safety in the rain and dark
- Mesh outer pockets keep drinking bottles, maps and a hat within reach
- Slide compartment for hydration system in the main compartment; with tube holes
- Quick release fasteners on the straps make it easy to put on - even over a jacket!

- AIRSTRIPES back system\* for the perfect wear comfort

Dimensions: 40 x 25 x 20 cm

Capacity: approx. 15 litres

Weight: only 800 g

Material: Hextop 210d Nylon (yellow), Super-Polytex 600d Polyester (black)

### \*AIRSTRIPES Carrying system:

Shoulder straps with MeshTex. The anatomical shape guarantees pleasant freedom of movement. The height chest strap ensures the shoulder straps are an optimum fit. The detachable hip strap provides a compact fit in any riding situation.

Two contoured nubbed foam profiles with an AirMesh cover provide maximum air circulation through minimum contact with the back.

055-0270 black/yellow

055-0271 black/anthracite



## Hooks for pannier lid, set of four

The ZEGA hooks make it easier than ever to secure your luggage.

- Suitable for all ZEGA and BMW Adventure panniers
- Suitable for 20 mm belts (e.g. ZEGApack) Baggage attachment made easy!

050-0885



### Source WIDE PAC

The brilliant thing about WIDE PAC is its huge opening. This means that the WIDE PAC can be filled, cleaned and dried easily. There's also no problem filling it with ice cubes (-20 °C to +80 °C).

Over thousands of miles we have been able to ensure that the closure is completely watertight (even when lying flat in the tank bag!).

070-0170 2 Ltr., 170 g



### Touratech first aid kit for motorcycles DIN 13167

This kit contains all the essential items for motorcyclists that are required to meet the DIN 13167 standard. Self-adhesive bandage tape, self-adhesive dressing, rolls of bandage, a first aid blanket, scissors, vinyl gloves and first aid instructions are included.

Size: 15 x 10 x 5 cm | Weight: 240 g

070-0132

## TOURATECH Drinking bottle 0,6 litres

Yellow with black cap and logo

Content: 600 ml

Weight: 81 g

Dimensions: Ø 74 x 200 mm

070-0530



070-0530

## Aluminum Bottle

Lightweight aluminium drinking bottle with screw cap.

made of 99.7% aluminium

- extremely lightweight
- tasteless and odourless
- BPA, phthalate and lead-free
- suitable for carbonated beverages
- suitable for recycling

Dimensions: 74 Ø x 242 mm

Opening for filling: 26 mm

Weight: 114 g

Note: not suitable for dishwashers or microwave ovens, do not freeze filled. Rinse prior to use

070-0008 „Touratech Essentials“, 0,6 litres



070-0008





### DOWN

inner: 100% nylon  
outer: 100% nylon  
filling: 100% down

## Touratech TOUR

- 2-way YKK-zipper
- Z-box chamber construction
- material: Toray Airtastic SLF15 (100% polyamide)
- Filling material: European goose down 95/5 (750+ cuin fill power)
- hanging loops
- inside pocket
- compression stuff sack and storage sack

Comfort temperature: approx. 6 °C

Limit temperature: approx. 1 °C

Extreme temperature: approx. -14 °C

Contains non-textile parts of animal origin.

070-0892	M	170 cm
----------	---	--------

070-0893	XL	200 cm
----------	----	--------



## Touratech TRIP

### Down

- 2-way YKK-zipper
- X-box chamber construction
- material: Toray Airtastic SLF15 (100% polyamide)
- Filling material: European goose down 95/5 (750+ cuin fill power)
- hanging loops
- inside pocket
- compression stuff sack and storage sack

Comfort temperature: approx. 15 °C

Limit temperature: approx. 12 °C

Extreme temperature: approx. -1 °C

Contains non-textile parts of animal origin.

070-0892	M	170 cm
----------	---	--------

070-0893	XL	200 cm
----------	----	--------

## Touratech TRAVEL

- 2-way YKK-zipper
- Z-box chamber construction
- material: Toray Airtastic SLF15 (100% polyamide)
- Filling material: European goose down 95/5 (750+ cuin fill power)
- thermal collar
- hanging loops
- inside pocket
- compression stuff sack and storage sack

Comfort temperature: approx. 1 °C

Limit temperature: approx. -5 °C

Extreme temperature: approx. -22 °C

Contains non-textile parts of animal origin.

070-0894	M	170 cm
----------	---	--------

070-0895	XL	200 cm
----------	----	--------

## Insulated foam sleeping pad Thermarest Trail Pro

With its generous thickness of 5.0 cm, the self-inflating Trail Pro offers a perfect balance between low weight and maximum comfort. Through additional internal air cushions, we were able to reduce weight and pack size without compromising the thermal properties. The high insulating effect makes this sleeping pad the right choice for all those for whom sleeping comfort is of the utmost importance. Includes packsack

Weight: 910 g / 2 lb, Dimensions: 63 x 183 x 5 cm / 25 x 72 x 2 in  
 Thermal resistance (R-value): 4  
 (the higher the R-value, the better the insulation)

070-1817



055-0385



055-0386

## Touratech toiletries bag TOUR

More than just a wash bag! The optimum size, the many useful details and the robust workmanship make our TOUR toiletries bag the ideal companion on any trip wherever you are - in the wilderness, camping or in a hotel.

Capacity: approx. 3,3 litres

Size: 19 x 22 x 8 cm

Weight: 290 g

- two zip pockets
- mesh pocket with zip
- one large coat hook to fold down
- large main compartment with three mesh pockets
- elasticated band with loops
- removable inner section with hook
- all-round zip
- removable mirror
- large hook for hanging it up

055-0385



## Touratech toiletries bag TRAVEL

The bathroom to take with you! The TRAVEL toiletries bag, your new companion on great adventure trips. Despite its small size, this toiletries bag provides enough space - it's even big enough to cover the needs of two travellers.

Size: 25 x 25 x 9 cm

Capacity: approx. 5,6 litres

Weight: 360 g

- two zip pockets, one with access from inside and outside
- mesh pocket with zip
- two large coat hooks to fold down
- large main compartment with three mesh pockets
- Elasticated band with loops
- removable inner section with hook
- all-round zip
- removable mirror
- large hook for hanging it up

055-0386

**SINCE 2010**

INSPIRATION FÜR MOTORRADREISENDE

TOURATECH

NUMMER 24 DE  
ISSUE 1 / 2018

# TRAVEL TIME

Verkleidung für R 1200 GS  
**DESIERTO V**



**F 850 GS UNLEASHED**



ZUBEHÖR  
Die neue Desierto V  
Verkleidung für R 1200 GS  
Special BMW F 850 GS  
Modellverzierung & Parts

REISE  
Pyrenäen  
Curation  
Adventure Classics  
ACT Romania

FAHRRERAUSSTATTUNG  
Adventure Carving  
Hilfsmittel für den Überlandverkehr  
Batteriehändlung  
Mit Air Touring

INSPIRATION FÜR MOTORRADREISENDE

TOURATECH

NUMMER 25 DE  
ISSUE 2018/19

# TRAVEL TIME



**ABENTEUER P...**

TRAILM-TRIP  
USA - Der Südwesten

OFFROAD-BOYX  
Helmwerk-Box

ZUSA  
Das neue Helm-Set

BMW R1200 GS & Adventure - BMW F850 GS  
Doppel-Multimediale Enduros-Video-Action-Trip &  
KTM 790 & 1290 Adventure

INSPIRATION FÜR MOTORRADREISENDE

TOURATECH

NUMMER 26 DE  
ISSUE 1/2019

# TRAVEL TIME



**ADVENT...**

BMW R1200 GS & Adventure - BMW F850 GS  
Doppel-Multimediale Enduros-Video-Action-Trip & KTM 790 & 1290 Adventure





Stories, photos, gear and people:  
A free print magazine full of inspiration for motorcycle travellers and Touratech customers since 2010.



Subscribe or pick it up  
at your nearest  
Touratech dealer!

GET YOUR  
FREE COPY

WWW.TOURATECH.COM



## TOURATECH GmbH

Auf dem Zimmermann 7-9  
78078 Niedereschach  
Germany

**Managing Directors:**  
Marc Pelzer, Alberto Reinhart

Registry Court: Local court Freiburg  
Registration number: HRB 717302

Sales Tax ID: DE 815728417  
WEEE-Reg. No. DE 42167489

Tel: +49 7728 9279-0  
Fax: +49 7728 9279-1112  
E-mail: [info@touratech.de](mailto:info@touratech.de)

Link to the EU online dispute settlement  
platform: <https://ec.europa.eu/consumers/odr/>

### General terms and conditions and information for consumers in respect of distance sales contracts

#### § 1 Scope of application

For business relations with the purchaser, the following General Terms and Conditions apply to orders within Germany that are not received via Touratech's internet shop.

These General Terms and Conditions do not apply to customers who order via our internet shop.

#### § 2 Conclusion of contract

The customer's order is a binding offer to conclude a contract.

In the case of orders by post, fax or e-mail, Touratech can accept the offer within ten days either by sending an order confirmation in text form or by ensuring that the customer receives the ordered goods within this period. In this respect, the time of receipt of the order confirmation or the goods by the customer is decisive.

In the case of an order by telephone, acceptance

of the customer's offer to conclude an agreement can only be declared by Touratech before the end of the telephone call. Otherwise, the customer's offer to conclude the contract shall be deemed to have been rejected.

#### § 3 Prices

All prices are in Euro, including the legal value added tax plus shipping costs if applicable.

#### § 4 Payment, shipping costs, delivery time

(1) The purchase price is due immediately upon conclusion of the contract.

##### (2) Payment options

The following payment options are available:

- Prepayment by direct debit through the direct debit authorisation procedure. A shortened period for advance notice of the SEPA Core Direct Debit of three calendar days is agreed.
- Advance payment by bank transfer.
- Prepayment by credit card, Visa/Mastercard. Your account will be debited upon conclusion of the contract.
- Prepayment via PayPal payment.

You will receive specific payment information upon conclusion of the contract.

##### (3) Shipping costs

Goods are delivered exclusively within Germany. The shipping costs for deliveries within Germany are EUR 4.95. For orders with a gross value of goods of EUR 299.00 or more, shipping is free of charge.

##### (4) Delivery time

Delivery time is 10 days from the customer's payment instruction or direct debit or credit card charge.

#### § 5 Retention of title

The delivered goods remain our property until full payment of the purchase price.

#### § 6 Liability for defects

There is a statutory right of liability for defects for the goods. Liability for defects shall be governed by the statutory provisions.



## § 7 Information on the dispute settlement procedure before a consumer arbitration board

We are neither willing nor obliged to participate in a dispute settlement procedure before a consumer arbitration board.

## § 8 Information for consumers in respect of distance contracts

Complaints and claims for liability for defects can be lodged at the following address

TOURATECH GmbH

Auf dem Zimmermann 7-9

78078 Niedereschach

Germany

info@touratech.de

## Note concerning take-back obligations in accordance with the Waste Oil Ordinance

In accordance with the Waste Oil Ordinance, we are obliged to take back used combustion engine or transmission oils free of charge equal to the volume of combustion engine and transmission oils sold to the individual customer in order to dispose of them properly. This also applies to oil filters and the oil-containing waste regularly produced during oil changes. You can therefore send the used oils, oil filters or oil-containing waste regularly produced during oil changes to us, free of charge, for proper disposal as hazardous goods.

## Information on the return of waste batteries

Batteries must not be disposed of in household waste. The rubbish bin symbol indicates batteries containing harmful substances and the fact that batteries must not be disposed of with household waste but in a professional manner. End users are legally obliged to return waste batteries. We are obliged to notify you of the fact that batteries can be returned to us free of charge after use. You can therefore send waste batteries to us for proper disposal



The chemical designation of the metals contained in the battery can be found near the rubbish bin symbol. „Cd“ stands for cadmium, „Pb“ for lead and „Hg“ for mercury.

## Information according to the Electrical and Electronic Equipment Act for private households

1. Electrical and electronic equipment that has become unusable is considered to be waste equipment. Owners of waste equipment must dispose of this waste equipment separately from unsorted municipal waste. Waste equipment must therefore not be disposed of with household waste. Consequently, the equipment is marked with the following symbol of a crossed-out rubbish bin:



The symbol of a crossed-out rubbish bin, which is regularly displayed on electrical and electronic equipment, specifies that the respective device must be collected separately from unsorted municipal waste at the end of its service life.

2. Owners of waste equipment must separate spent batteries and accumulators that are not encased in the waste equipment from the equipment before handing it over at a collection point, unless the waste equipment is handed over to public waste management authorities and separated from other waste equipment there, for the purpose of preparation for re-use.

3. Owners of waste equipment from private households can hand this in at the collection points of the public waste management authorities or at the take-back points set up by the manufacturers or distributors within the meaning of the Electrical and Electronic Equipment Act. An online list of collection and take-back points can be found at <https://www.ear-system.de/ear-verzeichnis/sammel-und-ruecknahmestellen>

4. Waste information technology and telecommunications equipment as well as computers and smartphones may contain personal data. You are responsible for deleting this data from this waste equipment before disposing of it.



## Withdrawal policy and sample withdrawal form for consumers

The right of withdrawal expires prematurely in the case of distance contracts

- with regard to the delivery of sound or video recordings or computer software in a sealed package, if the seal has been removed after delivery.

### Withdrawal policy

#### Right of withdrawal

You have the right to withdraw from this contract within fourteen days without providing any reason.

The withdrawal period is fourteen days from the day on which you or a third party named by you, who is not the carrier, have taken or has taken possession of the last goods.

To exercise your right of withdrawal, you must contact

**TOURATECH GmbH**  
**Auf dem Zimmermann 7-9**  
**78078 Niedereschach**  
**Germany**  
**Tel: +49 7728-9279-0**  
**Fax: +49 7728-9279-1112**  
**eMail: info@touratech.de**

submitting a clear declaration (e.g. a letter sent by post, fax or e-mail) about your decision to withdraw from this contract. You can use the attached sample withdrawal form, which is however not mandatory.

In order to comply with the withdrawal period, it is sufficient if you send notification of the exercising of the right of withdrawal before the expiry of the withdrawal period.

#### Consequences of withdrawal

If you withdraw from this contract, we are obliged to refund all payments we have received from you, including delivery costs (with the exception of additional costs resulting from the fact that you have chosen a type of delivery other than the cheapest standard delivery offered by us), without delay and at the latest within fourteen days of the day on which we received notification of your withdrawal from this contract. For this repayment, we use the same means of payment that you used for the original transaction, unless expressly agreed otherwise with you; in no case will you be charged for this repayment. We may refuse repayment until we have received the goods back or until you have provided proof that you have returned the goods, whichever is the earlier. You must return or hand over the goods to us without delay and in any case no later than fourteen days from the day on which you notify us of withdrawal from this contract. The deadline is deemed to be met if you send the goods before the expiry of the period of fourteen days. We bear the costs of returning the goods. You are only liable for any loss in value of the goods if this loss in value is due to handling of the goods that is not necessary for testing the quality, characteristics and functioning of the goods.

#### End of the withdrawal policy

# Sample withdrawal form



If you wish to withdraw from the contract, please fill in and return this form.

**TOURATECH GmbH**  
**Auf dem Zimmermann 7-9**  
**78078 Niedereschach**  
**Germany**  
**Telefax: +49 7728-9279-1112**  
**Email: info@touratech.de**

I/we (\*) hereby withdraw from the contract concluded by me/us (\*) for the purchase of the following goods (\*)/the provision of the following service (\*)

\_\_\_\_\_  
 Ordered on (\*)/received on (\*)

\_\_\_\_\_  
 Name of the consumer(s)

\_\_\_\_\_  
 Address of the consumer(s)

\_\_\_\_\_  
 Signature of the consumer(s) (only in the case of notification on paper)

\_\_\_\_\_  
 Date

(\*) Delete as applicable.

# CERTIFICATED TOURGUIDES

We congratulate the first Touratech certified guides.  
In the future you will find further information about  
A.R.T.T. at [www.touratech.com/artt](http://www.touratech.com/artt)



**David Johansson**  
Touratech Nordic



**David Rynhart**  
Touratech Ireland



**Filipe Elias**  
Touratech Portugal



**Iván Guerrero**  
Touratech Perú



**Jens Wehrle**  
Touratech HQ



**Peera Laohakarniyom**  
Touratech Thailand



**Saleh Sharif Alkhatay**  
Touratech Middle East



**Tommy Lee**  
Touratech Malaysia



# TOURATECH GIFT VOUCHERS

Spreading joy is so easy: You can't go wrong with Touratech gift vouchers. The TOURATECH gift vouchers are sent complete with the current catalog in a neutral carton. And the recipient of your gift will be delighted and pleasantly surprised by the gigantic Touratech product portfolio.

Gift voucher 10 Euro	10,00 €
Gift voucher 25 Euro	25,00 €
Gift voucher 50 Euro	50,00 €
Gift voucher 100 Euro	100,00 €

USA: [touratech-usa.com](http://touratech-usa.com)  
UK: [touratech-uk.co.uk](http://touratech-uk.co.uk)  
CANADA: [motomotto.ca](http://motomotto.ca)  
INTERNATIONAL: [touratech.com](http://touratech.com)



[touratech.com](http://touratech.com)  
All the news at a glance!  
Shop from home!



Touratech Facebook  
Be connected to the Touratech-Team!  
[facebook.com/touratech](https://facebook.com/touratech)

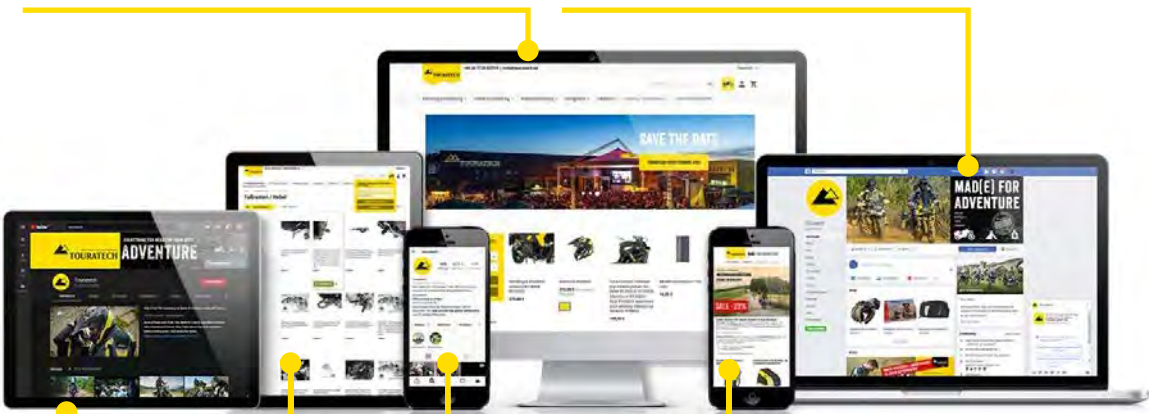

[touratech.com](http://touratech.com)  
Shop from home!  
All the news at a glance!



Touratech Newsletter  
Discover the latest news and offers!  
[www.touratech.com](http://www.touratech.com)



Touratech YouTube  
Watch the latest Adventure-Videos!  
[youtube.com/TouratechVideo](https://youtube.com/TouratechVideo)



Touratech Instagram  
Get inspired!  
[instagram.com/touratech](https://instagram.com/touratech)

- + All the new features at a glance
- + New product topics and exciting travel stories as well as comprehensive news coverage of Touratech events
- + Special offers and new items
- + Detailed product information incl. 360° views, videos and mounting instructions

[WWW.TOURATECH.COM](http://WWW.TOURATECH.COM)

# CONTACT

## Touratech Germany contact, question and ordering form

Our catalogue contains the latest product range and comprehensive information about our articles. Special offers, detailed information, up-to-date product images, possible price changes and more can be found in our new online shop ([shop.touratech.com](http://shop.touratech.com)). Changes and updates are immediately undertaken by us and made available on the Internet. A special service for you is the availability of almost all our assembly instructions in PDF format for download.

Touratech worldwide already has distributors in more than 50 countries on all continents. We are only too happy for you to turn to these colleagues with your questions about products and availability. Even in Germany the distances to Touratech have become shorter. Alongside the head office in Niedereschach, there are seven Touratech branch offices in Germany. You can find all our contact information starting from page 4.

You are welcome to contact us in Niedereschach or simply drop by. In our retail outlet with its large exhibition area, you can view, test and purchase our products.

### Our opening hours (retail outlet):

**Monday through Friday** 10 AM - 6 PM  
**Saturday** 10 AM - 2 PM

To improve our communication with you and to make our service faster and more reliable, we have set up various telephone numbers and e-mail addresses. Please make sure your query is addressed to the appropriate contact. Our hotlines are open Monday through Friday 9 AM - 6 PM (Support hotline November to March 9 AM - 5 PM).

## INFO HOTLINE

Comprehensive information and competent advice is available by phone on

**+49 (0) 77 28 92 79-0**

by e-mail at  
or by fax on

**info@touratech.de**  
**+49 (0) 77 28 92 79-1112.**

## ORDER HOTLINE

You can order our free catalogue and place orders without any advice by phone on

**+49 (0) 77 28 92 79-1111**

by e-mail at  
or by fax on

**order@touratech.de**  
**+49 (0) 77 28 92 79-1112**

## SUPPORT HOTLINE

If you require our help, whether during fitting of purchased parts or about spare parts required, please contact us by telephone on

**+49 (0) 77 28 92 79-1222**

by e-mail at  
or by fax on

**support@touratech.de**  
**+49 (0) 77 28 92 79-1112**

**INFO** Phone: **+49 (0) 77 28 92 79-0**  
eMail: **info@touratech.de**

**ORDER** Phone: **+49 (0) 77 28 92 79-1111**  
eMail: **order@touratech.de**

**SUPPORT** Phone: **+49 (0) 77 28 92 79-1222**  
eMail: **support@touratech.de**





**TOURATECH UK**  
 touratech-uk.co.uk  
 info@touratech-uk.co.uk  
 Phone: +44(0) 208 089 96 92

**TOURATECH UK NORTH**  
 Hermod  
 322G Mayoral Way  
 Team Valley | Gateshead  
 NE11 0RT, UK  
 Phone: +44 (0)1914 871 123  
 info@hermod.co.uk  
 www.hermod.co.uk

**TOURATECH UK SOUTH**  
 Rugged Roads Ltd  
 Sway Garage  
 Durnstown, Hampshire  
 SO41 6AL, UK  
 Phone: +44(0) 1590 675 657  
 touratech@ruggedroads.co.uk  
 Website: ruggedroads.co.uk

**TOURATECH UK SOUTH EAST**  
 Adventure Bike Shop Ltd  
 Unit 19 Inca Business Park  
 Melford Road | Acton,  
 Sudbury, Suffolk CO10 0BB  
 Phone: +44(0) 1787 372 901  
 enquiries@  
 adventurebikeshop.co.uk  
 www.adventurebikeshop.co.uk



**TOURATECH USA SEATTLE**  
 4021 Airport Way South  
 Seattle, WA 98108, USA  
 Phone: +1 206 323.2349  
 Toll free: +1 800 491 2926  
 sales@touratech-usa.com  
 www.touratech-usa.com

**TOURATECH USA MIAMI**  
 7501 NW 36th Street  
 Miami, FL 33166, USA  
 Phone: +1 (786) 845 0052  
 WhatsApp: +1 (786) 452 4218

**Bob's BMW / TOURATECH**  
 Bob's BMW Motorcycles  
 10720 Guilford Road  
 Jessup, MD 20794  
 Phone: +1 301-497-8949  
 www.bobsbmw.com

**Touratech USA East**  
**COMING SOON!**



**TOURATECH CANADA**  
 1661 chemin de l'industrie,  
 Local 111  
 Beloeil, Québec J3G 0S5  
 CANADA  
 www.touratech-canada.com  
 info@touratech-canada.com  
 Phone: 450 919.3223



**TOURATECH SOUTH AFRICA**  
 Bike Adventure Imports (Pty) Ltd  
 Unit A008, One Highveld  
 5 Bellingham Road  
 Centurion, Gauteng 0157  
 SOUTH AFRICA  
 Phone: +27 (0) 12 665 1139  
 Cell: +27 (0) 60 786 6185  
 info@touratech.co.za  
 www.touratech.co.za



**TOURATECH NORDIC**  
 Phone: +49 7728 92 790  
 info@touratech-nordic.com  
 SWEDEN: se.touratech-nordic.com  
 FINLAND: fi.touratech-nordic.com  
 NORWAY: no.touratech-nordic.com  
 DENMARK: dk.touratech-nordic.com



**TOURATECH AUSTRALIA**  
 1933 Carboor,  
 Everton Rd.  
 Victoria 3678  
 AUSTRALIA  
 Tel: +61 3 57 29 55 29  
 www.touratech.com.au



**TOURATECH PORTUGAL**  
 Avenida Infante D. Henrique  
 Edifício Beira Rio, Fracção T  
 1950-408 Lisboa  
 PORTUGAL  
 Tel: +351 218 650 244  
 www.touratech.pt



**TOURATECH HEADQUARTERS**  
 Auf dem Zimmermann 7-9  
 78078 Niedereschach  
 GERMANY  
 Tel: +49 (0)7728 92 79-0  
 www.touratech.com

**TOURATECH Australia**  
 www.touratech.com.au  
**TOURATECH Austria**  
 www.touratech.at  
**TOURATECH Argentina**  
 www.touratech.ar  
**TOURATECH Belgium**  
 www.touratech.be  
**TOURATECH Canada**  
 www.touratech-canada.com  
**TOURATECH Chile**  
 www.mototechnik.cl  
**TOURATECH China**  
 www.touratech.cc  
**TOURATECH Colombia**  
 www.touratech.com.co  
**TOURATECH Costa Rica**  
 www.touratech.co.cr  
**TOURATECH Czech Rep.**  
 www.touratech.cz  
**TOURATECH Denmark**  
 dk.touratech-nordic.com  
**TOURATECH Ecuador**  
 www.touratech.ec

**TOURATECH El Salvador**  
 www.touratech.com.sv  
**TOURATECH Finland**  
 fi.touratech-nordic.com  
**TOURATECH France**  
 www.touratech-france.com  
**TOURATECH Greece**  
 www.makan.gr  
**TOURATECH Guatemala**  
 www.touratech.com.gt  
**TOURATECH Hungary**  
 www.touratech.hu  
**TOURATECH India**  
 www.touratech.in  
**TOURATECH Ireland**  
 www.overlanders.ie  
**TOURATECH Israel**  
 www.touratech.co.il  
**TOURATECH Italy**  
 www.touratech.it  
**TOURATECH Japan**  
 www.touratechjapan.com  
**TOURATECH Korea**  
 www.touratech.kr

**TOURATECH Malaysia**  
 www.touratech.com.my  
**TOURATECH Mexico**  
 www.touratech-mex.com  
**TOURATECH Middle East**  
 www.touratech.ae  
**TOURATECH Netherlands**  
 www.touratech.nl  
**TOURATECH New Zealand**  
 www.touratech.co.nz  
**TOURATECH Norway**  
 no.touratech-nordic.com  
**TOURATECH Peru**  
 www.touratech.pe  
**TOURATECH Philippines**  
 www.touratech.ph  
**TOURATECH Poland**  
 www.touratech.pl  
**TOURATECH Portugal**  
 www.touratech.pt  
**TOURATECH Romania**  
 www.touratech.ro  
**TOURATECH Russia**  
 www.touratech.ru

**TOURATECH Serbia**  
 www.touratech.rs  
**TOURATECH Singapore**  
 www.touratech.sg  
**TOURATECH Slovakia**  
 www.touratech.sk  
**TOURATECH South Africa**  
 www.touratech.co.za  
**TOURATECH Spain**  
 www.touratech.es  
**TOURATECH Sweden**  
 se.touratech-nordic.com  
**TOURATECH Switzerland**  
 www.touratech-swiss.ch  
**TOURATECH Taiwan**  
 www.touratech.tw  
**TOURATECH Thailand**  
 www.touratech.co.th  
**TOURATECH Turkey**  
 www.touratech-tr.com  
**TOURATECH UK**  
 www.touratech-uk.co.uk  
**TOURATECH Vietnam**  
 www.touratech.vn