

**CORONDO CONTROLS LTD
BOLTON BL1 2PT**

www.coronadocontrols.com

CELECT

DRF3

RF Thermostat

Instruction Manual

TABLE OF CONTENT

A. Installation and Mounting	3
1. Installation	3
2. Wiring	4
3. Mounting	4
B. Start/Reset	6
C. Normal Time Mode	7
D. Temperature Setting Up	7
E. Jumper Selection	8
F. Address Setting	8
G. Specification	9

Terminal block connecting Label:

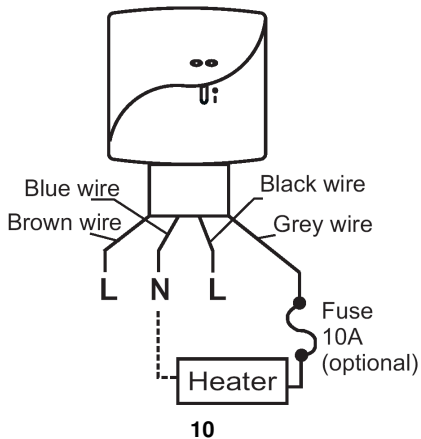

G. Specification:

1. Temperature measurement: 0.0 - 40°C
(0.1°C/step)
2. Accuracy: ± 0.5°C
3. Temperature control range: 5.0 - 35.0°C
(0.5°C/step)
4. Terminals: 2.5mm² cable
5. Electronic control: Type 2.B action
6. Transmitter—Battery: 2 x 1.5V AAA alkaline
battery
7. Receiver—Input voltage: 240Vac
8. Receiver—Output voltage: 24..240Vac 50/60Hz
10(3)A max
9. Operating temperature: 0 - 50°C
10. Storage temperature: -10 - 60°C
11. Sensing Element: NTC thermistor

DRF3 RF Thermostat

1. The system includes one wireless thermostat controller plus one RF receiver.
2. Transmits up to 20 meter indoor.
3. Communicates at 868MHz (Europe Standard) and designed for unlicensed operation under FCC Part 15.

Warning:

1. If there is a dead zone in the RF communication. That means the receiver may not be able to receive the message from the transmitter. Before the installation, check the communication first. If the communication fails, relocate the receiver and transmitter location.
2. If the receiver has interference, set another transmitter address. Reset the transmitter and follow the set up instruction to reset the receiver.
3. It is recommended locate at least 30cm distance from any metal objects (including the metal box) and at least 2 meter from any electronic devices e.g. radio TV, PC,

etc. The metal objects or electronic devices maybe interfere with the RF communication, so maximum distance will be shorter.

4. Do not mount onto metal wall boxes.

A. Installation, Mounting:

Caution:

Turn off DRF3 and the electrical devices (e.g. heater, cooler) which will be connected before installation. It is highly recommended that the installation procedure is processed by trained personnel.

1. Installation Location:

The thermostat (Receiver and Transmitter) should be mounted on an inner wall 1.5m above the floor in position where it is readily affected by changes of the general room temperature with freely circulating air. Prevent direct exposure to sunlight; dripping or splashing area.

Do not place this unit at a location where air circulation is

3

2. Return the room temperature display after 10seconds with the <  > icon disappears.

E. Jumper Selection:

Delay / No Delay jumper:

	Heater	Cooler
No delay	10sec	4mins
Delay	4mins	4mins

Choose the Delay option if compressor heat is connected.



Heater/Cooler jumper:

Select the heater option when a heater is connected to the receiver. Select the cooler option when a cooler is connected to the receiver.



F. Address setting:

In transmitter and receiver, there are dip switches to select the addresses. The receiver ignores the message which is sent by the transmitter with different address



8

3. Switch ON the heater/cooler and receiver. The heater/cooler will remain OFF until transmitter activates the output ON with  /  displayed on LCD.

C. Normal Time Mode:

1. Temperature detection starts and LCD displays the room temperature.
2. If Battery is LOW,  will be On. The old batteries must be replaced with new one immediately.
3. Defrost function is activated with  displayed when temperature is 5°C or below. Output will be forced to ON @ Heat & OFF @ Cool.
4. Below 0°C, transmitter will display **LO**.
5. Above 40°C, transmitter will display **HI**.

D. Temperature Setting Up:

1. Select the comfortable temperature by pressing <  > or <  > to desirable temperature.

7

low, or where it has great temperature changes (e.g. near door). Do not place the thermostat near heat/cool generating sources.

2. Wiring:

Caution: Turn off the electrical devices and receiver before wiring.

There is 4-wire cable provided

Color	Connection
Brown	240Vac Live
Blue	240Vac Neutral
Black	240Vac Live
Grey	Device's power input

-It is recommended that a 10A fuse is fitted at grey wire. (Please refer to the wiring diagram on the last page.)

3. Mounting:

Using the accessory screws and wall anchors provided, mount DRF3 with the key-hole at the back. The transmitter and receiver should be mounted on the wall

4

and install the covers on them.

Install or replace the battery for transmitter:

Caution: Turn off the electrical devices and disconnect the supply to the appliances before replacing the batteries. Replace only with the same or equivalent type of batteries. Do not dispose the used batteries with household waste. Refer to your local area for the proper disposal.

1. Pull out the battery drawer
2. Place the new batteries according to the marking on the battery drawer.
3. Dispose the old batteries properly. Slide the battery drawer back to its position.
4. Check if the thermostat works properly or not. Press "Reset" if necessary.

5

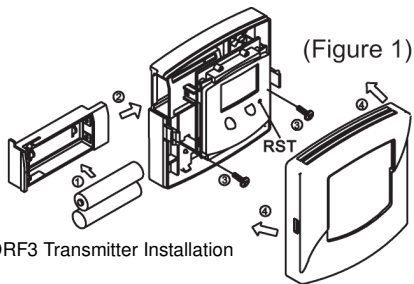

B. Start/Reset:

1. After wiring and mounting, switch off all the connected devices. Place 2 new AAA 1.5V alkaline batteries according to the polarities marked. LCD display will be switched on.
2. Press 'RST' to reset. The DRF3 will be ready to control the heater / cooler.

6