

CELECT

CTS-S / CTS-G

Touch Screen Programmable Thermostat
For
7 Days Setting

**CORONDO CONTROLS LTD
BOLTON BL1 2PT**

www.coronadocontrols.com

Instruction Manual

TABLE OF CONTENT

| | |
|-----------------------------------|----|
| A. Installation and Mounting..... | 1 |
| 1. Installation..... | 1 |
| 2. Wiring..... | 2 |
| 3. Mounting..... | 4 |
| B. Features..... | 6 |
| C. Setup Mode..... | 7 |
| D. Operations..... | 11 |
| - View Calendar..... | 11 |
| - Clock Setting..... | 11 |
| - Clean Screen Mode..... | 12 |
| - Usage..... | 12 |
| - Program Mode..... | 14 |
| - Normal Mode Operations..... | 17 |
| E. Electrical Specification..... | 20 |

E. Electrical Specification

| | |
|--|----------------------------------|
| Temperature measurement: | 0~40°C / 32~99°F |
| Control temperature range: | 5~35°C / 41~95°F |
| Temperature resolution: | 0.5°C / 1°F |
| Temperature accuracy: | ±0.5°C / ±1°F |
| Battery: | 2 X AA alkaline battery |
| Relay contact Voltage: | 230Vac 50/60Hz |
| Relay contact Current: | 8A Max |
| Classification of control: | Class II |
| Purpose of control: | Micro-disconnection on operation |
| Electronic control: | Type 2.B |
| Terminals: | Flexible Cord Conductors |
| Nominal cross-sectional area of the conductor to be fitted in the terminal block | 1 ~ 2.5mm ² |



■ This symbol indicates separate collection for electrical and electronic equipments.

A. Installation, Mounting:

CAUTION:

1. Turn off CTS-S / CTS-G electronic source and the electrical devices(e.g. heater, cooler) which will be connected before installation and maintenance.
2. The installer must be a trained service personnel.
3. Disconnect the supply before battery replacement.
4. Replace only with the same or equivalent type of batteries
5. Do not dispose the used up battery with the household waste. Please refer to your local area for proper disposal.
6. It must be mounted on a dry clean indoor place.

1. Installation Location:

The thermostat should be mounted on an inner wall 1.5m above the floor and its position should be readily affected by changes of the general room temperature with freely circulating air.

Prevent direct exposure to sunlight, dripping or splashing area. Do not place the unit at a location where air circulation is slow, or where it has great temperature changes (e.g. near door). Do not place the thermostat near heat generating sources (radiators, hot air vents, TV or lights).

2. Wiring:

For Heat Mode

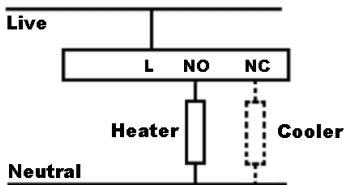

2

"LO" will be shown when room temperature is below 0°C / 32°F



"HI" will be shown when room temperature is above 40°C / 99°F

When the relay is turned on, "HEAT ①" or "COOL ①" icons are shown.

Low Battery

If the voltage batteries drop below 2.7V,  icon will be on. The battery is detected every hour.

19

3. Press  or  to change the override setting temperature.

Temporary override returns to normal mode when the next program starts.

Permanent override keeps using the override setting temperature unless user manually switches to other modes.

System Setting

In Normal mode, press "SYSTEM" to enter System mode.

System mode is set in the sequence of:

HEAT → COOL → OFF → HEAT...

| System Mode | |
|-------------|--|
| HEAT MODE | Relay will be turned on when the room temperature is lower than the setting temperature |
| COOL MODE | Relay will be turned on when the room temperature is higher than the setting temperature |
| OFF MODE | Relay will always be turned off at any temperature. |

Caution:

- TURN OFF any electrical devices before wiring.
- There are 3 terminals. Connect "L" to the power supply and connect "NO" to heater or cooler.
- Push all cables back into wall prior to fixing to avoid trapping wires.
- Do not use metal conduit or of cable provided with a metal sheath.
- Recommend adding Fuse or protective device in the live circuit.

User may connect both heating and cooling appliance to terminal NO and NC. However, user has to make sure only one appliance is allowed to turn on at a time. If heater is used and heater is not turned on by CTS-S / CTS-G, the cooler should be turned off manually.

3. Mounting:

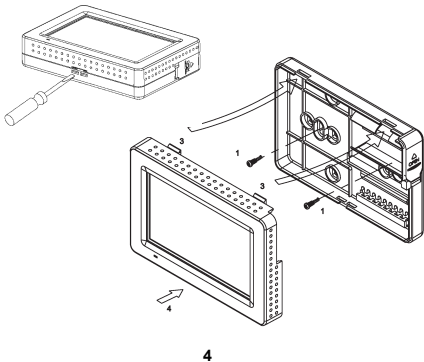

Normal Mode Operations

Cool mode:

Relay is turned on:

Measured temperature \geq Setting temperature + Span

Relay is turned off:

Measured temperature \leq Setting temperature - Span

Heat mode:

Relay is turned on:

Measured temperature \leq Setting temperature - Span

Relay is turned off:

Measured temperature \geq Setting temperature + Span

Off mode:

Relay is always turned off.

Override mode

1. Press  to select (temporary) override, permanent override and program.
2. Default heat/cool override setting temperature is 26°C /79°F.

Default program settings are shown as below:

| | Mon - Fri | Sat - Sun |
|---------------------|--|--|
| Program1 (Wake) | 6:00 Heat - 21°C /70°F Cool - 26°C /79°F | 6:00 Heat - 21°C /70°F Cool - 26°C /79°F |
| Program2 (Out) | 8:00 Heat - 16°C /61°F Cool - 29.5°C /85°F | 10:00 Heat - 16°C /61°F Cool - 29.5°C /85°F |
| Program3 (Lunch) | 12:00 Heat - 21°C /70°F Cool - 26°C /79°F | 12:00 Heat - 21°C /70°F Cool - 26°C /79°F |
| Program4 (Out) | 14:00 Heat - 16°C /61°F Cool - 29.5°C /85°F | 14:00 Heat - 16°C /61°F Cool - 29.5°C /85°F |
| Program5 (Back) | 18:00 Heat - 21°C /70°F Cool - 26°C /79°F | 18:00 Heat - 21°C /70°F Cool - 26°C /79°F |
| Program6 (Night) | 22:00 Heat - 16°C /61°F Cool - 29.5°C /85°F | 22:00 Heat - 16°C /61°F Cool - 29.5°C /85°F |

1. Base housing
 - i. Adjust the base on the wall or junction box and ensure that the base is at surface level and cover the junction box comfortably.
 - ii. If necessary, pull the cables out through the hole of the base.
 - iii. If necessary, place 2 pcs of wall anchors in the wall.
 - iv. Fasten the base with 2 pcs of long screws.
 - v. Place the cables at the hole near the terminal block.
2. Hold the thermostat on the base.
3. Push the thermostat straight onto the base until it snaps into place.
4. Insert 2 AA batteries into the battery case on the thermostat. Note the polarity of the batteries. Do not mix batteries of different type or different brand. Do not use old and new batteries simultaneously.



B. Features:

- 7-day, 6-time-zone heat/cool program settings
 - EEPROM stores heat and cool program settings
 - Fast Program Copy
 - Temperature display in °C or °F
 - Temperature Measurable Range: 32–99 °F / 0–40 °C
 - Override Mode (Temporary / Permanent)
 - Real clock in 12/24-Hour Display
 - Adjustable Temperature Control Span
 - LCD Backlighting
 - Energy, UV lamp Usage counters
 - Defrost Control
 - Clean Screen Mode
 - Calendar
 - Security Mode
6. Press **EXIT** to discard any changes and exit program setting.
 7. Press **CONF M** to save settings and select another day to set the program.
 8. If Press **Fn** enter to copy mode, the selected day disappear and show another weekday keys.
 9. Press other weekday with which you want to copy the program to. Selected weekdays will have no surrounded.
 10. Press **EXIT** to discard any changes and exit copy mode.
 11. Press **CONF M** to process the copy and exit copy mode.

Program Mode

1. Press "PROG" to enter the program mode.



2. Press weekday to select the program day.
3. Press **PROG** to review or update the program.
4. Or Press **Fn** to copy the program (see step 8).
5. Press  or  to change the time (minimum time period is 10mins), heat or cool setting temperature and the program periods 1 to 6.



14



Setup Mode

There are 7 settings in the setup mode:



1. Calendar
2. 12/24 hours selection
3. C/F display selection
4. Span Selection
5. Delay/ Long delay selection
6. DST (Daylight savings time)
7. Security Lock

Press and hold **SYSTEM** for 5 seconds to enter setup mode. In setup mode, press **EXIT** to discard changes made to current setting and exit setup mode. Press **CONFIRM** to apply changes and proceed to next setting.

Calendar



Press  or  to change the year, month and year

24/12 Hours

Press  or  to choose either 12hr (12 hours) or 24hr (24 hours) representation.

7



C/F Display

Press  or  to select the temperature unit to be used.

C – Celsius, F – Fahrenheit. *Conversion error may occur.*

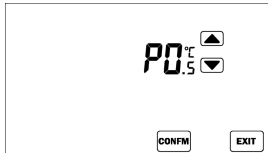

Span Selection



Press  or  to change span setting. The selectable values are 0.5°C(1°F) / 1.0°C(2°F) / 1.5°C(3°F). The temperature unit depends on temperature unit selected by user.

2. UV and Energy counter are shown alternatively by pressing **USAGE**
3. Press **CLEAR** to clear the current counter records.
4. Press **EXIT** to exit the usage mode.

Adjusting Usage Limit

1. Press and hold **USAGE** for 2 seconds during the usage mode.
2. Press  or  to change the limit time (0~9999).
3. Press **CONFIRM** to save the setting
4. Press **EXIT** to exit the limit setting.
5. Adjust the interval time to zero for disabling counting.

Defrost

When the room temperature is below or equal to 5°C / 40°F, defrost control will be turned on. During defrost, heater will always be turned ON and cooler will always be turned OFF irrespective to the current temperature control setting. Defrost indicator  will be shown on the screen.

Clean Screen Mode

1. Press **CLEAR** to enter the cleaning screen mode
2. The screen will show a 20-second countdown immediately after the key press
3. During countdown, all keys are disabled.
4. When countdown reaches zero, press **EXIT** to exit clean screen mode or press **CLEAR** repeat the countdown.



Usage

CTS-S / CTS-G can record UV and Energy usages. These counters count hourly. Each count is 4-digit long (0~9999). UV usage counts as long as CTS-S / CTS-G is powered on assuming that user is using a UV lamp for 24-hour. Energy usage counts when heater or cooler is turned on. When the counts reach the set limit, the corresponding usage icon will be shown on the screen.

View Usage

1. Press **USAGE** to enter the usage mode.



Delay / Long Delay

Press  or  to toggle between Delay and Long Delay.



The use of the Delay is to prevent short cycling of system for turning on heater or cooler.

| | Delay | Long delay |
|-----------|---------|------------|
| Heat mode | 5~10sec | 4~5 min |
| Cool mode | 4~5 min | 4~5 min |

DST (Daylight Savings Time)

Press  or  to enable or disable DST function.
Remark: The DST is based on the EU time zone.

Security Lock

Press  or  to enable(ON) or disable(OFF) the security lock. If it is enabled, user is required to input a 4-digit password.

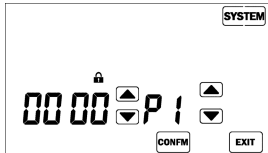

Press or on the left to change the password. P1 indicates that the 1st digit password (read from left) is selected for edit. Press or on the right to select the digit wanted to edit.

After setting all 4 digits, press **CONFIRM** to activate the security mode. When security mode is activated, “” is shown on the LCD and all keys are disabled except “SYSTEM”.

*If the password is 8888, all settings will restore to default upon pressing **CONFIRM***

Disable the Security Lock

1. Press **SYSTEM** and user is required to enter the correct password
2. If the password is correct, the security lock will be disabled. Otherwise, it remains locked.

Remark : Security Lock cannot be maintained once power is lost

Operations

View Calendar

1. Press the current weekday to view current date.
2. Press **EXIT** to exit the viewing.

Clock Setting

1. Press **CLOCK** to enter the clock setting mode.
2. Firstly, the hour is shown. Press or to change the hour. Press **CONFIRM** to save the setting.
3. Then, the minute is shown. Press or to change the minute. Press **CONFIRM** to save the setting and exit clock setting.