

CELECT

CC852KIT

RF Programmable Thermostat
for
7 days Setting

**CORONDO CONTROLS LTD
BOLTON BL1 2PT**

www.coronadocontrols.com

Instruction Manual

TABLE OF CONTENT

A. Installation and Mounting	3
1. Installation	3
2. Mounting	4
3. Receiver Addressing.....	5
B. Key Interface.....	7
C. LCD Interface.....	8
D. Start/Reset	9
E. Operation Mode	10
F. Time Setting Mode	11
G. Program Setting Mode.....	12
H. Internal Setting Mode.....	14
I. Address Matching.....	15
J. Temperature Setting.....	16
K. Specification.....	17



K. Specification

Frequency:	868Mhz
Temperature Measurement:	0°C~40°C
Accuracy:	±0.5°C
Temperature Controllable Range:	5°C~35°C
Resolution:	0.5°C
Power Supply:	2 x AAA alkaline batteries
Operating Temperature:	0°C~50°C
Storage Temperature:	-5°C~50°C
Sensing Element:	NTC thermistor
Classification of control:	Class II
Purpose of control:	Micro-disconnection on operation
Electronic control:	Type 1.B
Receiver—Input voltage:	240Vac 50/60Hz
Receiver—Output Rating:	240Vac 13A (max.)



SEPARATE COLLECTION FOR ELECTRICAL
AND ELECTRONIC EQUIPMENT WASTE.

CC852KIT RF Programmable Thermostat

1. The system includes one wireless thermostat controller plus one RF receiver Plug.
2. Transmits up to 20 meter indoor
3. Communicates at 868MHz(Europe Standard) and designed for unlicensed operation under FCC Part 15.

Notice:



1. Before the installation, check the RF communication. (Receiver receives on/off msgs) If the communication is not good, relocate the receiver and transmitter location.
2. If the Receiver / Transmitter fails to communicate set another address code which must match in both Transmitter & Receiver Units
3. It is recommended locate at least 30cm distance from any metal objects (including the metal box) and at least 2 meter from any electronic devices e.g. radio TV, PC, etc. The metal objects or electronic devices may cause Interference and the maximum distance will be shorter.
4. To have the best communication, locate the receiver at a direction facing to the transmitter.



1. Installation Location:

Transmitter: should be mounted on an inner wall ~1.5m above the floor in position where it is readily affected by change of the room temperature with freely circulating air. Do not place the unit at a location where air circulation is low, or where it has great temperature changes (e.g. near door or heating source) irrespective of the current setting temperature.

Prevent direct exposure to sunlight; dripping or splashing area.



J. Temperature Setting

Press  or  once to activate the temperature setting. the setting temperature will be flashing.

Press  or  to increase or decrease the setting temperature. The set point will be saved for the current operation mode. (Comfort / Econ / Override)



Temperature Setting for Comfort Mode

Hold  until the temperature is flashing.

Press  or  to increase or decrease the comfort mode temperature.

Temperature Setting for Econ Mode

Hold  until the temperature is flashing.

Press  or  to increase or decrease the econ mode temperature.

I. RF Address Matching

Set the RF address in WT852T(Transmitter) by accessing internal setting.

Press  for "1" and  for "0" for the digit .

For example, If you are going to set 11110011,

Press  4 times, then  2 times and  2 times.

You will get **1 2 3 4** **7 8** in the display.

It means the RF address equal to 11110011.

To match the address for the receiver, set the dip switch as following. Switch in upper position means "1" and lower position means "0"



11110011

Now both transmitter and receiver having the same Address "11110011" and hence they will communicate.

15

2. Mounting:

Mounting (Transmitter):

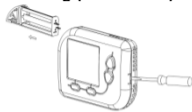

- Pull out the battery drawer

- Use a screwdriver to press on the spot to detach the front shell

- Insert 2 pcs of wall anchors into the holes of the wall.

- Fasten the thermostat with 2 pcs of screws through the mounting holes.

- Assemble the front shell to the base.

- Insert the battery drawer back to the position.

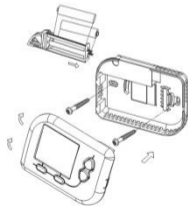

4

3. Receiver Address Accessing

1. Pull out the door by using a screwdriver.
2. Set the RF address. The receiver RF address must match the transmitter RF address.
3. Close and press the door until hearing a "click" sound.

Warning: Disconnect from supply before opening the door.

Upper Position: 1



lower Position: 0

e.g
Address: 11110011

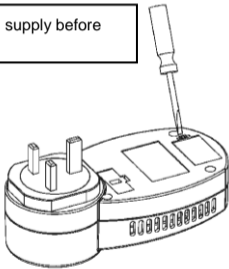

5

H. Internal Setting Mode:

- Hold **PROG** and **↔** key to enter internal setting.
Press **☀** or **🌀** to switch items and adjust value.
Press **↔** for item selection and confirm.
Press **PROG** to exit the setting.

System Mode: HE – Heat mode (default) CL – Cool mode	545
Display Unit: 12 – 12 hour display unit 24 – 24 hour display unit (default)	Hr
Minimum Off Delay: Sd – Short delay (default) Ld – Long delay - 5 min.	dLY
Temperature Calibration: -3 - 3°C. 0°C (default)	CAL
RF Address 00000000 – 11111111 (default)	Rdr

14

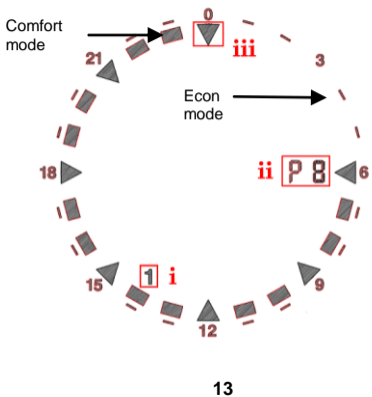

Receiver LED Indication

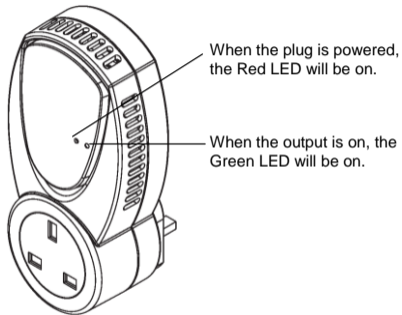

B. Key Interface



Keys	Function
	Set point up / Comfort Mode Assignment
	Set point down / Econ Mode Assignment
	Program Setting Key
	Program, Override mode selection / Enter

G. Program Setting Mode:

Press to enter program setting.

i) Press or to select weekday

Press to confirm.

ii) Press or to select the program.

P0 – P7 are the default programs and P8 – P15 are the editable programs. Press to confirm.

iii) If P0 – P7 has been selected, the program assignment is finished. If P8-P15 is selected, the

cursor at the top will be flashing. Press or to locate the cursor. Press to confirm.

iv) Press to assign Comfort mode and for Econ mode for time slots. Press to confirm.

v) Press for exit after the setting is finished.

F. Time Setting Mode:

Hold ☀️ and 🌙 to go to time setting.

i) Press ☀️ or 🌙 to adjust “weekday”.

Press ⏪/⏩ to confirm.

ii) Press ☀️ or 🌙 to adjust “hour”.

Press ⏪/⏩ to confirm.

iii) Repeat the same procedure for “minute”.

Press (PROG) for exit after the time setting is done.



11

C. LCD Interface Introduction



10. Temperature

11. Time



12. Day

13. Program Number

8





D. Start/Reset:

1. Place 2 pcs AAA 1.5V alkaline batteries according to the polarities marked.
2. LCD display will be switched on.

If there are any display or functional errors, please remove the batteries for about 30 sec to reset the thermostat.
3. Temperature detection starts and LCD displays the room temperature.
4.  will be flashing if Battery is LOW. Replace the battery immediately.
5. Defrost function is activated with  displayed when temperature is 5°C or below. Output will be ON @ Heat mode & OFF @ Cool mode.
6. LCD will display **Lo** if temperature is below 0°C,
7. LCD will display **Hi** if temperature is above 40°C,
8. Insert the receiver plug to power socket.

E. Operation Mode:

Press  key to switch between the 3 operation modes below.

1. Program Mode  or  will be displayed
The thermostat controls the room temperature according to the programs.
2. Temporary Override Mode  or  will be displayed
The thermostat controls the room temperature according to the override temperature temporarily, and returns to Program mode for the next Comfort / Econ mode transition.
3. Permanent Override Mode  will be displayed
The thermostat controls the room temperature according to the override temperature permanently.