



GAMMON TECHNICAL PRODUCTS, INC.
P.O. BOX 400 - 2300 HWY 34
MANASQUAN, N.J. 08736

PHONE 732-223-4600
FAX 732-223-5778
EMAIL gammontech@gammontech.com

**MINI MONITOR®
& MULTI MINI
MONITOR KITS**

**BULLETIN 8
(8-11)**

MINI MONITOR® KIT - MARK II

The Mark II version has the unique advantage of eliminating the "white spot". The photograph of a filter membrane shows how all previously manufactured test kits regardless of the brand, make a white spot in the center if the inlet pressure is high and the fuel sample is contaminated. The jet effect causes the white spot.

In the new MARK II design, the inlet fuel to the plastic monitor is dispersed laterally to insure a more uniform distribution of particles over the entire surface.

The MINIMONITOR KIT is used to test aviation fuel for particulate contamination using the procedures described in ASTM D2276. A measured volume of fuel is passed from a flowing pipe directly through a 0.8 micrometer membrane. The plastic monitor holding the membrane is placed in an aluminum housing. Dirt particles are caught on the membrane which can be visually color rated or weighed for a gravimetric rating.

The MARK II version has the unique advantage of eliminating the white spot in the center of the membrane (see photograph) which is caused by the fuel entering the monitor at a high pressure. The drawing shows how the fuel is dispersed laterally, avoiding the jet effect.

- The white spot in the center of the membrane is avoided with our new discharge pattern.

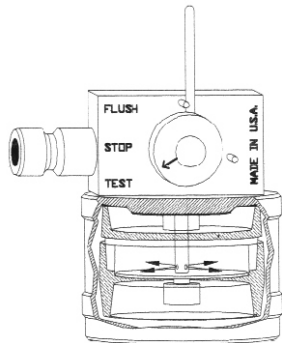
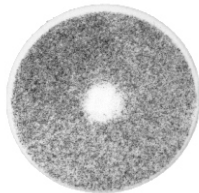

- The drawing shows the unique discharge tube that enters the plastic monitor. The large area of the 4 holes insures that the flow rate is not affected.

- Stainless Steel Parts - test sample comes in contact only with stainless steel before reaching filter membrane.

- The Mini Monitor® Kit was developed by Gammon Technical Products, Inc., specifically for aircraft fuel testing with standard field monitors. This kit with carrying case weighs only 4 lbs.

- The new style carrying case provides a cavity that accepts the assembled kit; eliminates the need to disassemble each time the apparatus is stored.



•Order GTP-172 Mark II for Complete Test Kit

Includes: Carrying case, assembled housing and selector valve, bonding and grounding hose assembly, GTP-165 syringe, sampling kit GTP-5, GTP-2099 tweezers, GTP-1074-1 color rating booklet, GTP-1985-6 plastic monitors (6), GTP-1267 Mini Envelopes (15).

•MiniMonitor Assembly Only is available as GTP-172H

Includes: Housing, valve and complete hose assembly.

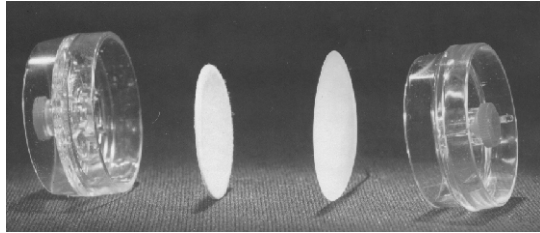

Mini Monitor Equipment uses standard plastic monitors listed by ASTM for Method D2276/IP-216

The Mini Monitor housing includes a flushing valve located on top of the monitor with a by-pass hose and fittings. Before flushing sample connection, move arrow located on flushing valve handle to STOP position. Check connections of bypass hose for firm seating. After connections have been checked, move arrow to the FLUSH position and allow one gallon (or specified volume) to collect in a measuring container. Then turn the valve to the TEST position to direct flow through the filter membrane. This test volume may be from 1 to 5 gallons depending upon contract provisions. The membrane is then rated as to its color using the GTP-1074-1 color rating booklet included in the kit. The darker the membrane, the dirtier the fuel. Some contracts require the weight of contaminant to be determined. The same apparatus can be used but arrangements must be made with a laboratory.

Electrical bonding is a safety requirement of ASTM Method D2276. Our Bonding and Grounding Hose Assembly clips to the metal measuring container (not shown) and also to pipe fitting shown in the photograph.

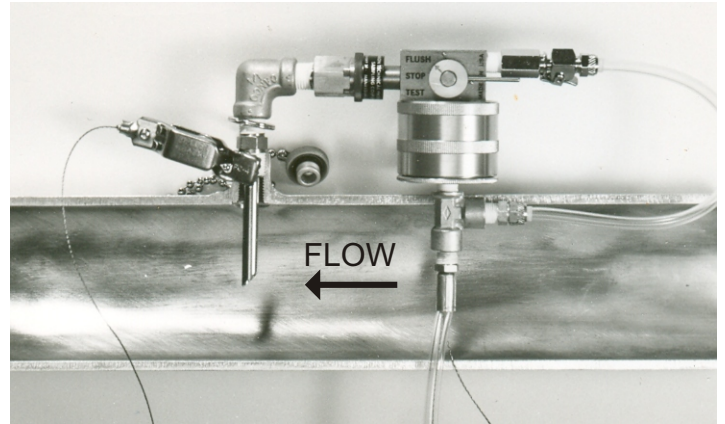

BONDING & GROUNDING HOSE ASSEMBLY - GTP-1110

Static charges are developed at a very high rate when aviation turbine fuel is passed through a filter membrane. These charges develop at an even higher rate when the fuel contains anti-static additive, but they are easily carried away by electrically bonding and grounding. Our model GTP-1110 is specially designed for this purpose.

CABLE DATA: Type 304 stainless steel, 1/32" (0.79mm) diameter, 21 strands
CABLE LENGTH: 10 feet (3.0 METERS)
TUBING LENGTH: 6 feet (1.8 meters)

SPECIAL ACCESSORIES FOR US MILITARY



STAINLESS STEEL HOLDER FOR AQUA-GLO WATER DETECTOR PADS

MODEL GTP-3326 for 25mm Water Detector Pads (Army)
 MODEL GTP-3850 for 37 mm Water Detector Pads (Air Force)

With holders, the Aqua-glo test can be performed using the MiniMonitor Housing.



FLEXIBLE EXTENSION TUBE Model GTP-5808
 Made especially for the US Air Force and for customers who have sampling connections in difficult places to reach. Overall length is 10 inches (250mm). The quick disconnect at the left end connects to the actuator at the inlet of the Mini Monitor housing. The actuator at the other end has the same dimensions as the one on the Mini Monitor. The Teflon® tubing is covered by stainless steel wire braid.

MULTI MINI MONITOR® TEST KIT

IT CONNECTS TO 5 DIFFERENT TYPES OF SAMPLING CONNECTIONS

This version of the test kit is made for operators who have to take samples from sampling points that are equipped with various different types of quick disconnects. See next page for available fitting types.



Model GTP-1172 Mark II shown



CONSIDER THESE FEATURES

- Clearly marked selector valve
- Bypass hose with quick disconnect for flushing
- Static charge bonding and grounding hose assembly
- Uses standard plastic monitors
- Improved sealing system - squeeze controlled- Viton A
- Stainless steel and anodized aluminum wetted parts throughout

UNIQUE DOUBLE ENDED ADAPTER Model GTP-988



THE KEY FEATURE OF MULTI MINI MONITOR TEST KIT

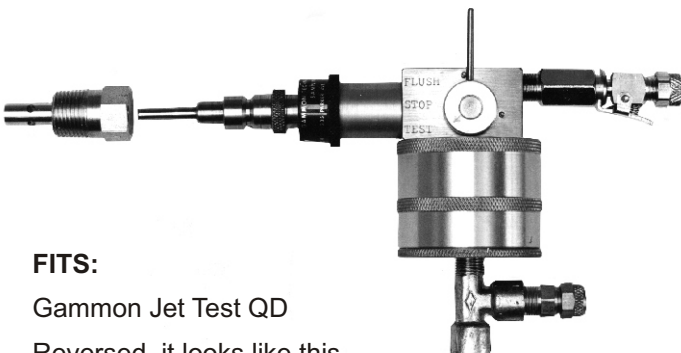

FITS:

Gammon Jet Test QD
Reversed, it looks like this

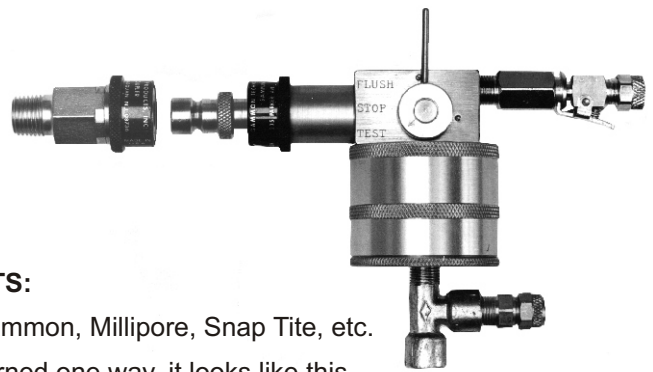

FITS:

Gammon, Millipore, Snap Tite, etc.
Turned one way, it looks like this

DESCRIPTION

The Multi Mini Monitor Kit, Model GTP-1172A Mark II includes a carrying case, housing, option A double-ended adapter, bypass hose quick disconnect, bypass tee, bonding and grounding hose, 6 plastic monitors, instruction booklet, syringe, Mini envelopes (15) and a GTP-1074-1 color rating book.

NOTE: For a list of items in this kit, see first page of this bulletin. The only difference is that a Kit No. 5 is not included.

HOW TO ORDER

Select the options you require and add them to your order. List options required by their GTP number. The GTP-988 double-ended adapter is included in all kits. If you require more than one, you may add that to your order.

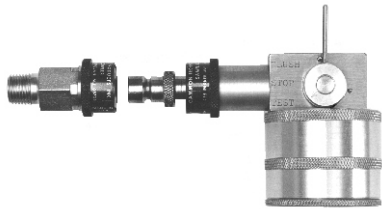

Fits Gammon Q.D., Millipore, Snap Tite, etc

GTP-988
Included

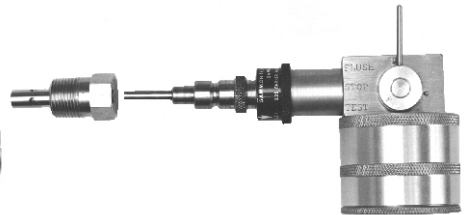

Also fits Gammon Jet Test QD

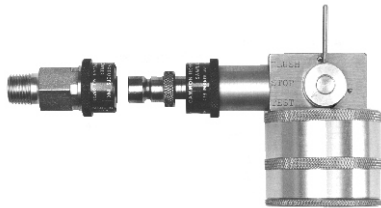

Fits Gammon Q.D., Millipore, Snap Tite, etc

GTP-988-1

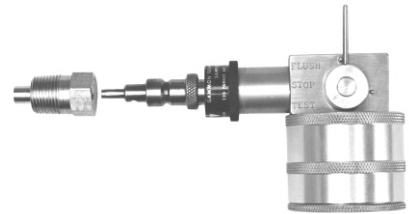

Also fits the short(S) or AH models of Gammon Jet Test QD

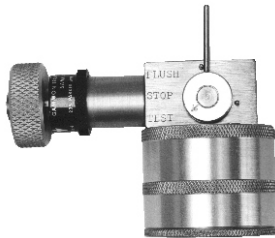

Fits Flight Refueling Ltd. Model #4127335 and #4127365 sampling adapters. (Thermal Controls type)

GTP-1170A



GTP-1170B

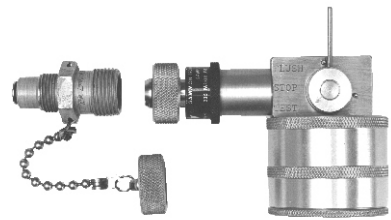

Fits Flight Refueling Ltd. Model #4127320, #4127345 and #4127350 sampling adapters. (Shell Int'l. type) NOTE: This fitment is the same as produced by A. Searle & Co., Stanhope Seta Ltd. and Holbek-Leba

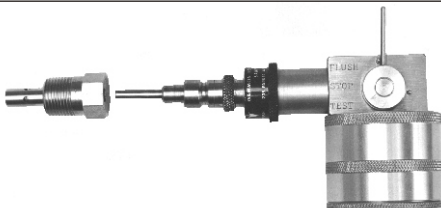

Fits Gammon Jet Test QD

GTP-988-2

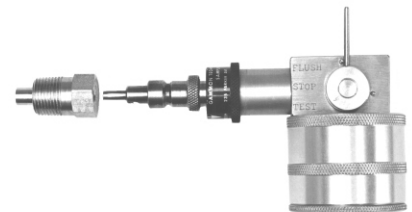

Also fits the short(S) or AH models of Gammon Jet Test QD

To order only the Multi Mini Monitor Housing with bypass hose, and bonding and grounding hose, specify GTP-1172H. No carrying case or other accessories will be included. Adapters must be specified.

ACCESSORIES:

GTP-1985
GTP-1983

Box of 48 plastic monitors
Box of 100 Membranes and support pads

GTP-992
Jet Test QD Models

Quick Disconnects (see Bull. 3)
Quick Disconnects (see Bull. 14)