

Motorcycle Workshop - Manual

MV AGUSTA BRUTALE ORO - S

BRUTALE



MV AGUSTA



Statement

This manual, to be used by the MV Agusta authorised workshops has been realised with the purpose of assisting authorised personnel in maintenance and repairs operations of the motorcycle. The knowledge of technical data herein noted, determines the complete professional training of the technician.

With purpose of making the reading of this manual immediately comprehensible, the paragraphs have been aligned with detailed illustrations that highlight the argument dealt with.

Useful advice

To prevent any problems and to reach an excellent final result, MV Agusta recommends keeping to the following guidelines:

- In the case of an eventual repair, evaluate the client's impressions who states that there is an abnormal functioning of the motorcycle and to formulate the right questions to clarify the symptoms of the problem.
- Clearly diagnose the cause of the abnormality. The basic fundamental theories can be absorbed by reading this manual that must necessarily be integrated to the personal experience and the participation of training courses that are periodically organised by MV Agusta.
- Rationally plan the repair to avoid slack periods, e.g. the collection of spare parts, the preparation of tools and equipment, etc.
- To reach the part to be repaired limiting the work to the essential operations. With regards to this, a valid help would be to consult this manual with regards to the sequences of removal demonstrated in this manual.

Informative note

MV Agusta S.p.A. is committed to a policy of continuous improvement of their products. For this reason, there could be slight differences between that which is written here and the motorcycle on which repairs and/or maintenance are about to be carried out. MV Agusta models are exported to many countries where different norms in relation to the highway code and homologation procedures are valid. Hoping that you will comprehend these problems, MV Agusta S.p.A. reserves the right to make modifications to its products and technical documentation at any moment and without prior announcement.



Respect and defend the environment

Everything that we do has repercussions on the entire planet and its resources.

MV Agusta, wanting to protect the interest of the people, would like to make the client and the technicians of the technical assistance centres aware and to adopt modalities of use of the motorcycle and the disposal of its parts in full respect of the norms in force in terms of environmental pollution, disposal and the recycling of waste.



General Index

GENERAL DESCRIPTION	A Rev. 0
MAINTENANCE	B Rev. 1
BODYWORK	C Rev. 0
AIR INTAKE INJECTION SYSTEM	D Rev. 0
ELECTRICAL SYSTEM	E Rev. 0
SUSPENSION AND WHEELS	F Rev. 1
FRAME	G Rev. 0
BRAKES	H Rev. 0
COOLING SYSTEM AND LUBRICATION SYSTEM.....	L Rev. 0
SPECIAL TOOLS	M Rev. 0
TORQUE PRESSURES	N Rev. 0
DIAGNOSTICS	O Rev. 0
ANALYTICAL INDEX	P Rev. 0



General description

A

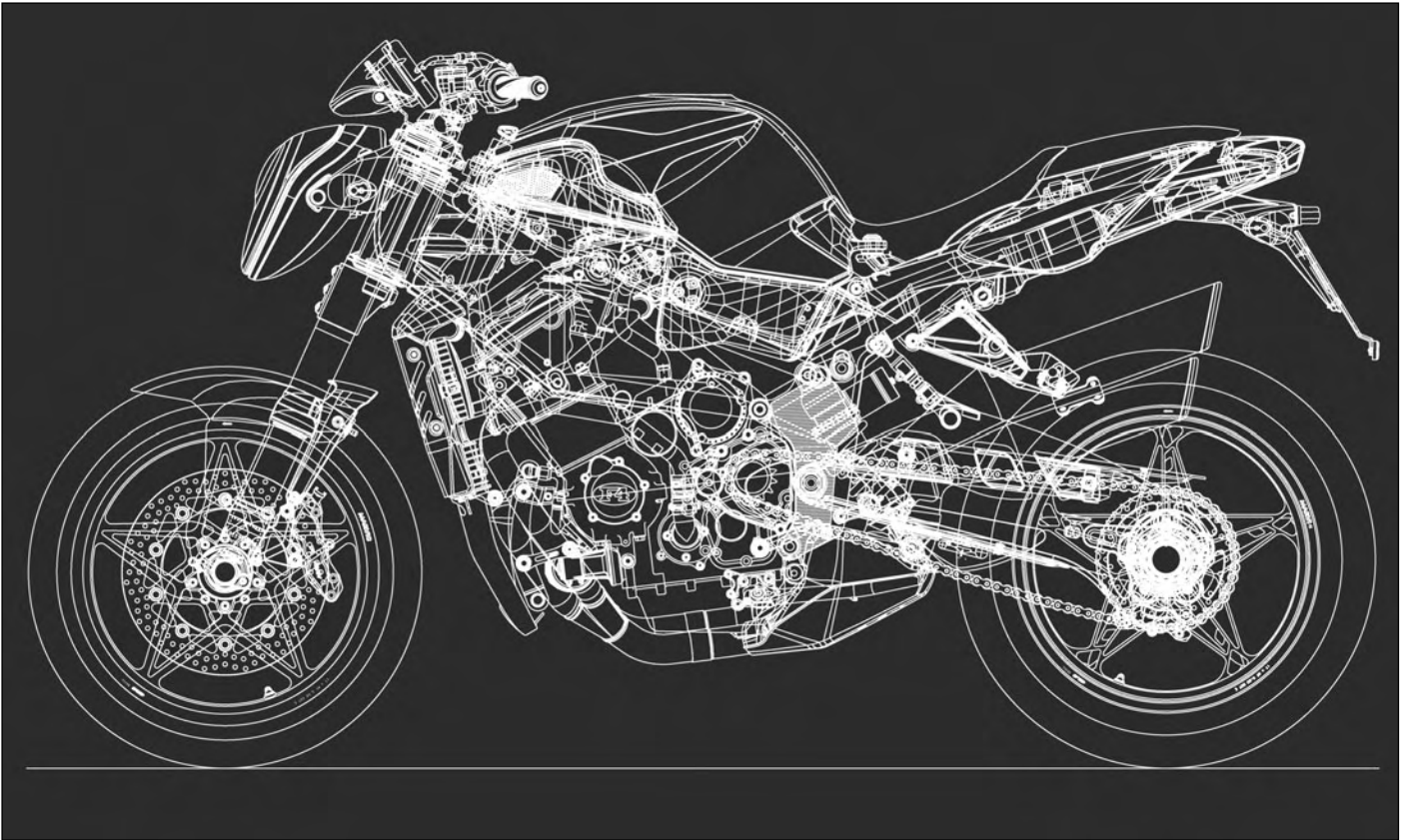

SECTION A
Revision 0



A

SUMMARY

HOW TO CONSULT THIS MANUAL	PAGE 3
PURPOSE OF THE MANUAL	PAGE 3
GLOSSARY AND SYMBOLS	PAGE 4
RIGHT HAND AND LEFT HAND STANDARD	PAGE 5
SAFETY	PAGE 6
WARNING	PAGE 8
INDEX	PAGE 8
OPERATIVE TECHNICAL SPECIFICATIONS	PAGE 9



General description

HOW TO CONSULT THIS MANUAL

Order of the subjects

This manual is divided into chapters that deal with the sub-groups of the motorcycle.

To quickly find the chapter required, the pages of each chapter are marked with a reference mark aligned to the relative item in the general index.



Display of the operations

The operations of disassembly, assembly, removal and control are presented with the help of illustrations (designs and photographs).

The illustrations contain symbols that indicate the procedure, special tools and other information. See the symbols lists for their significance.

The procedures are described step after step.

EXAMPLE

Steering pin tightening

Screw in the steering pin flange ring, without tightening.

This operation must be done manually.

Check that the steering base is at the end of its travel, to the right.

Using the special tool tighten the ring (1) by rotating it 10° calculated approximately as **one third** of the movement between the two holes of the ring (2) of the steering head (see the figure).

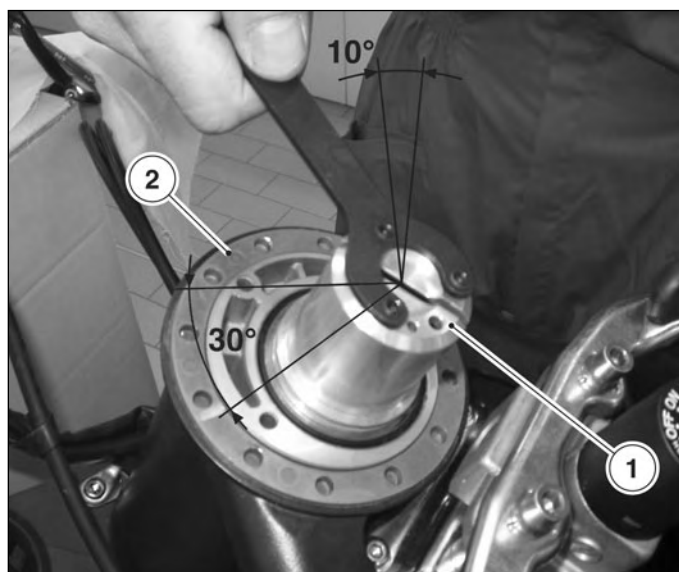

 **Specific tool N. 800091645**

PURPOSE OF THE MANUAL

Principally, this manual has been written for MV Agusta dealers and qualified mechanics.

It is not possible to document all the knowledge necessary for a mechanic in a manual. Those who utilise it must have a basic knowledge of mechanical concepts and the inherent procedures in the techniques of repairing motorcycles. Without this knowledge, The maintenance and repair operations can render the motorcycle unsafe for use.

Updates















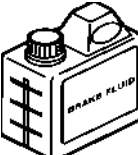

MV Agusta S.p.A. is committed to a policy of continuous updating of the models produced. The modifications and significant changes to the specifications and the procedures will be communicated to the official dealers and will appear in future editions of this manual.

All information, instructions and technical data included in this manual are based upon information on the product updated at the moment of going to print. MV Agusta S.p.A. reserves the right to carry out changes at any moment without prior notice and without incurring any obligation.

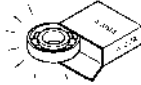

General description

A GLOSSARY AND SYMBOLS

- ▶  **ATTENTION** This signifies that the lack of or the incomplete observance of this advice can be gravely dangerous for your safety and for the safety of other persons.
- ▶  **WARNING** This signifies that the lack of observance of these instructions can bring the risk of damage to the motorcycle and the equipment.
- ▶ **N.B.** Supplies key information for the best fulfilment of the operation.
- ▶  Utilise a specific tool or equipment for the correct carrying out of the operation described.
- ▶  Tighten to the specified torque.
- ▶  Tolerance or limit of use.
- ▶  Utilise the tester.
- ▶  Use the recommended oil.
- ▶  Use the recommended grease.
- ▶  Use the recommended brake fluid
- ▶  Use the recommended suspension fluid.
- ▶  Use the recommended coolant.
- ▶  Use the recommended thread-locking fluid.
- ▶  Use the recommended sealant.
- ▶  Use the recommended adhesive.
- ▶  Carry out accurate cleaning.
- ▶  Use new components.
- ▶  Substitute the component.
- ▶  Do not leave litter about.
- ▶ ★ The information marked with this symbol refer to the F4 Brutale model series ORO.



General description

RIGHT HAND AND LEFT HAND STANDARD

In order to specify the right/left convention used within the chapters of this manual, see the following motorcycle and engine scheme where all sides which refer to are reported.

A

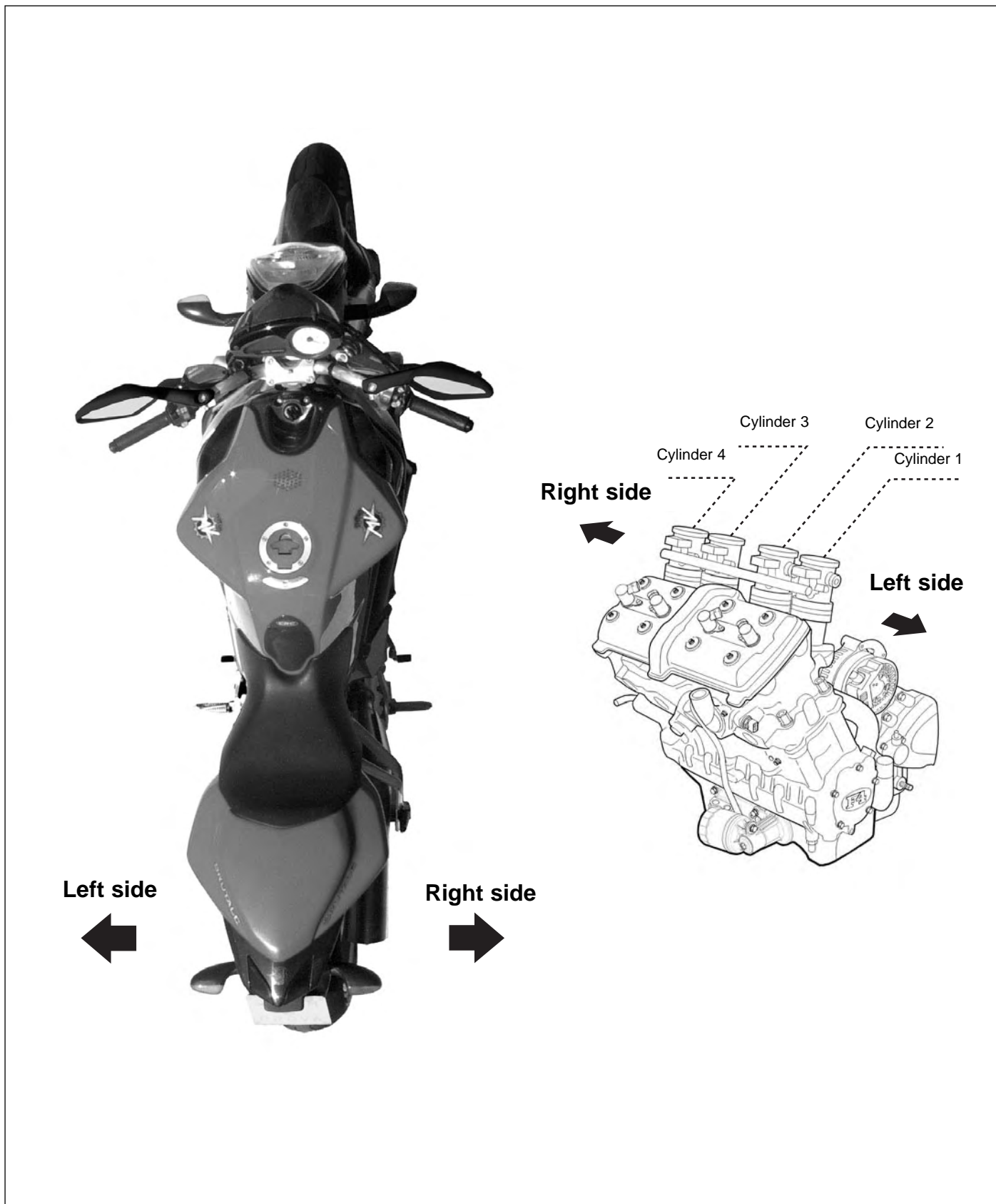



General description

A SAFETY



The information contained in this paragraph is fundamental so that the operations carried out on the motorcycle can be conducted with minimum risk to the mechanic.

Carbon Monoxide

- Exhaust gases contain carbon monoxide (CO) that is poisonous. Carbon monoxide can cause the loss of consciousness and death.
- If it is necessary to switch on the engine, check that the environment is well ventilated. Never switch on the engine in an enclosed environment.
- Switching on the engine can only be carried out in an enclosed environment when there are the appropriate devices for the evacuation of exhaust gases.

Petrol

- Petrol is extremely inflammable and under certain conditions can be explosive.
- Keep sources of heat, sparks and flames away from the work area.
- Always work in a well-ventilated area.
- Never use petrol as a cleaning solvent. Generally, avoid handling it unless it is absolutely necessary.
- Do not use petrol for cleaning components by using compressed air.
- Keep petrol out of reach of children.

Engine oil

- Engine oil can cause skin illnesses if in constant and long contact with the skin.
- If the skin comes into contact with engine oil, wash the parts affected as soon as possible with soap and water.
- If engine oil comes into contact with the eyes, abundantly rinse with water and consult a doctor immediately.
- If engine oil is swallowed, do not provoke vomiting to avoid the aspiration of the product into the lungs. Transport the injured person immediately to hospital.
- Used oil contains dangerous substances and poisonous for the environment. To substitute oil, it is recommended to go to an authorised MV Agusta dealer who is equipped to deal with the collection of used oil in respect of the norms in force.
- Do not dispose of used oil in the environment.
- Keep used oil out of the reach of children.

Engine coolant

- Under certain situations, the ethylene glycol contained in the engine coolant is inflammable and its flame is invisible. Ethylene glycol would cause serious burns if ignited because it is invisible.
- Avoid bringing the engine coolant into contact with hot parts. Such parts could be sufficiently hot to ignite the coolant.
- The engine coolant (ethylene glycol) can cause irritation of the skin and is poisonous if swallowed.
- If the engine coolant comes into contact with the skin, immediately remove any contaminated clothing and wash with soap and water. If it comes into contact with the eyes, abundantly rinse with clean water and immediately consult a doctor. If swallowed, do not provoke vomiting to avoid the aspiration of the product into the lungs. Administer clean water and transport the injured person immediately to hospital and show the product to the doctor.
- If exposed to high concentrations of vapour, transport the injured person to a non-poisonous atmosphere and if necessary call a doctor.
- Do not remove the radiator cap when the engine is still hot. Being under pressure, the engine coolant can be violently ejected and therefore provoke burns.
- The engine coolant contains dangerous and poisonous substances and is therefore dangerous for the environment. To substitute used engine coolant, it is advisable to go to the authorised MV Agusta dealer who is equipped to deal with the collection of used engine coolant in respect of the norms in force.
- Do not dispose of engine coolant in the environment.
- Keep engine coolant out of reach of children.



General description

A

Brake fluid

- Brake fluid is extremely corrosive.
- Avoid any contacts with the eyes, skin and the mucous membrane.
- If brake liquid comes into contact with the skin, remove all contaminated clothing and wash immediately with soap and water.
- If brake fluid comes into contact with the eyes, abundantly rinse with water and call a doctor.
- If swallowed, do not provoke vomiting to avoid aspiration of the product into the lungs. Immediately call a doctor.
- Take the injured person immediately to hospital, if he has breathed brake fluid into the lungs.
- In the case of exposure to high concentrations of vapour, move the injured person to a non-poisonous atmosphere and if necessary call a doctor.
- In the case of accidental contact, rinse abundantly with water and call a doctor.
- Keep brake fluid out of reach of children.

Thread-locking fluid

- As it is not classified as dangerous, the prolonged contact with the skin, particularly with regards to abrasions can provoke sensitiveness and dermatitis. In the case of contact with the skin, rinse abundantly with running water.
- Move the injured person into the open air and call a doctor if the injured person feels ill after having breathed in the product.
- In the case of contact with the eyes, rinse abundantly with water for at least 15 minutes.
- If the thread-locking fluid has been swallowed, drink an abundant quantity of water or milk. Do not provoke vomiting to avoid the aspiration of the product into the lungs. Immediately call a doctor.
- Keep out of reach of children.

Nitrogen - rear shock absorber

- The rear shock absorber contains nitrogen under pressure.
- Before disposing of used shock absorbers, discharge the nitrogen via the depressurising valve.
- Utilise only nitrogen to pressurise the shock absorber. The use of unstable gases can cause explosions that could cause burns.
- Do not place the shock absorber near to flames or sources of heat as this could cause explosions with consequent burns.
- Keep out of reach of children.

Battery

- The battery produces explosive gases. Keep it away from sparks, flames or cigarettes. During recharging, adequately ventilate the environment.
- The battery contains a solution of sulphuric acid (electrolyte).
- Sulphuric acid is corrosive and it destroys many materials and clothing. On contact with small quantities of water it generates a violent reaction that manifests itself by creating large quantity of heat and spurts of hot acid. Sulphuric acid attacks many metals thereby liberating hydrogen: an inflammable gas that forms an explosive mixture when mixed with air.
- Contact with sulphuric acid can cause burns. In the case of contact, remove immediately all contaminated clothing and wash the skin with abundant quantities of water. Take the injured person to hospital if necessary.
- In the case of contact with the eyes, rinse immediately with abundant water. Call a doctor and continue with the treatment until the doctor arrives.
- If the electrolyte is swallowed, rinse the mouth with water without swallowing. Take the injured person immediately to hospital and explain to the doctor there what the injured person has swallowed.
- The battery contains dangerous substances that are poisonous for the environment. It is advisable to substitute it at an MV Agusta dealer that is equipped to dispose of this product in respect of the norms in force.
- Do not dispose of used batteries in the environment.
- Keep out of reach of children.

Hot parts

- The engine and the exhaust system become very hot and maintain this temperature for some time after the engine has been switched off. Wait for these parts to cool down before handling them or working on the motorcycle near to them. Use protective gloves.



General description

A WARNING



WARNING

The information contained in this paragraph is important so that the operations carried out on the motorcycle can be conducted without damaging the motorcycle.

- Thoroughly clean the motorcycle before disassembling it.
- During disassembly, clean all parts and place them in containers respecting exactly the order of disassembly.
- Always use the special utensils where necessary and each time where prescribed.
- Always use adhesives, sealants and lubricants where prescribed. Respect the instructions about their technical characteristics.
- Always substitute parts such as gaskets, O-rings, security washers with new parts.
- Loosening and tightening nuts or screws, always start from the bigger ones or the centre. Always comply with the torque wrench settings.
- Utilise only MV Agusta spare parts.

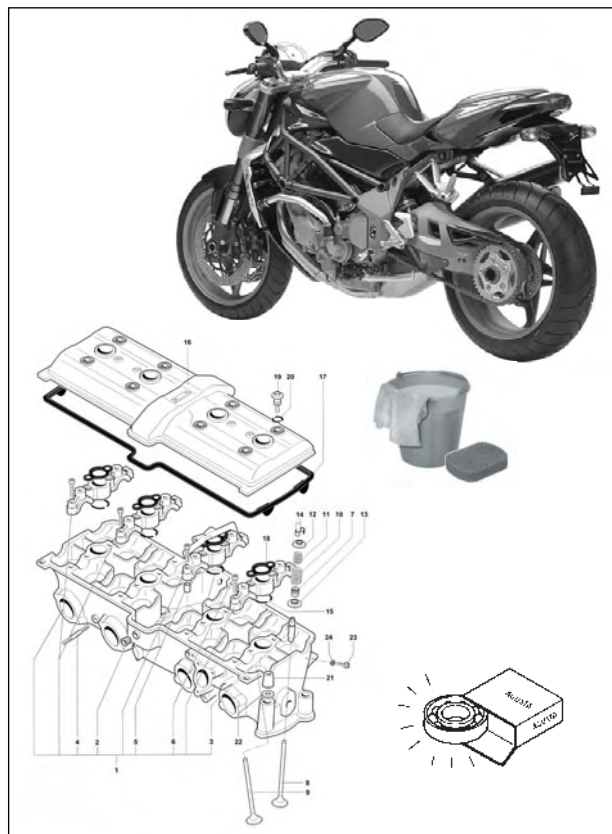

INDEX

GENERAL INDEX

Indice generale	
GENERALITÀ	A
MANUTENZIONE	B
SOVRASTRUTTURE	C
IMPIANTO INIEZIONE ASPIRAZIONE ARIA	D
MOTORE	E
SOSPENSIONI E RUOTE	F
TELAIO	G
FRENI	H
IMPIANTO ELETTRICO	I
IMPIANTO DI RAFFREDDAMENTO	L
ATTREZZATURA SPECIFICA	M
COPPIE DI SERRAGGIO	N
DIAGNOSTICA	O
INDICE ANALITICO	P

SUMMARY OF EACH CHAPTER

Generalità	
SOMMARIO	
COME CONSULTARE IL MANUALE	Pag.4
SCOPO DEL MANUALE	Pag.4
GLOSSARIO E SIMBOLUgia	Pag.5
SIGLE IDENTIFICATIVE	Pag.6
CONVENZIONE	Pag.6
SICUREZZA	Pag.6
AVVERTENZA	Pag.8
INDICE GENERALE	Pag.9
SOMMARIO DI OGNI CAPITOLO	Pag.9
SPECIFICHE TECNICHE OPERATIVE	Pag.10



General description

A

OPERATIVE TECHNICAL SPECIFICATIONS

MOTORCYCLE IDENTIFICATION

- 1) Frame registration number
- 2) Engine registration number
- 3) Homologation date
- 4) "Limited series" number ★

The registration number of the motorcycle is stamped on the right side of the steering head.

The engine part number is stamped on the top half casing near the fork.

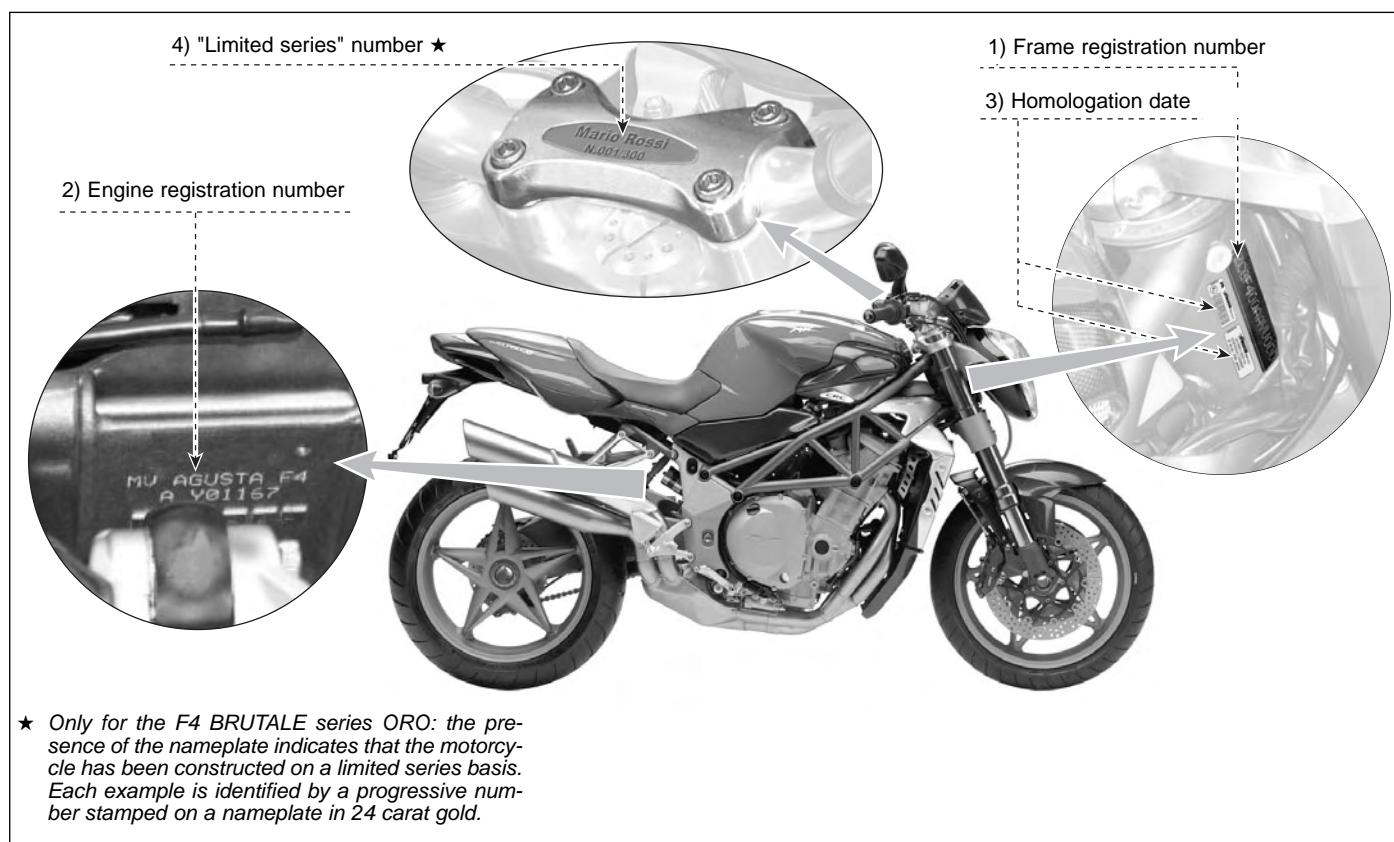

Below is an example of the designation of the frame registration number:

ZCG F4 01 AA Y V 000000

Manufacturer identification

Vehicle model

Progressive frame number



General description

A

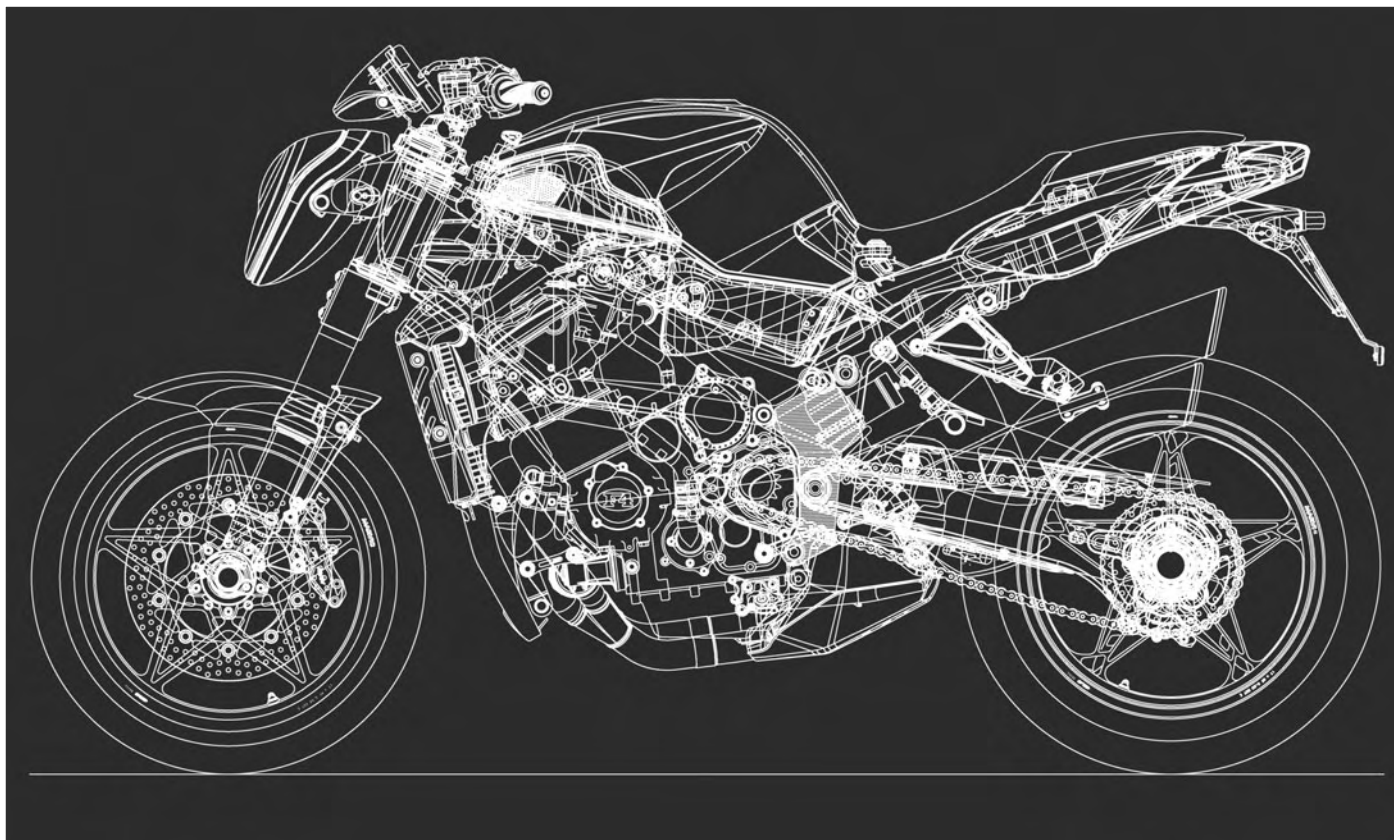

SECTION B

Revision 0



SUMMARY

TECHNICAL INFORMATION.....	PAGE 3
TECHNICAL DATA	PAGE 3
COMPONENTS IN CARBON FIBRE (F4 BRUTALE ORO)	PAGE 6
MAGNESIUM COMPONENTS (F4 BRUTALE ORO)	PAGE 7
PERIODICAL MAINTENANCE SCHEDULE	PAGE 9
MAINTENANCE AND TUNING OPERATIONS.....	PAGE 11
ENGINE OIL AND OIL FILTER.....	PAGE 11
ENGINE COOLANT	PAGE 19
ELECTRIC COOLING FAN.....	PAGE 21
VALVE MECHANISM ADJUSTMENT	PAGE 22
SPARK PLUGS.....	PAGE 33
FUEL FILTERS.....	PAGE 34
FUEL PUMP ASSEMBLY	PAGE 44
FUEL UNION TUBES	PAGE 47
FUEL TUBES ASSEMBLY	PAGE 47
THROTTLE BODY ADJUSTMENT AND TUNING	PAGE 50
AIR FILTER	PAGE 57
BRAKES AND CLUTCH.....	PAGE 60
BRAKE/CLUTCH/GEARCHANGE COMMANDS CHECK.....	PAGE 63
BRAKE PADS	PAGE 65
ACCELERATOR CONTROL.....	PAGE 65
LOCKS	PAGE 67
STEERING	PAGE 69
TRANSMISSION CHAIN.....	PAGE 69
TYRES	PAGE 72
FRONT WHEEL BEARINGS	PAGE 72
WHEELS	PAGE 73
REAR WHEEL HUB.....	PAGE 74
OSCILLATING ARM BEARINGS	PAGE 74
REAR SHOCK ABSORBER	PAGE 74
SIDE STAND	PAGE 75
FRONT FORK.....	PAGE 76
SCREWS AND NUTS	PAGE 76
TUBE BAND FASTENERS.....	PAGE 76
ELECTRICAL SYSTEM	PAGE 77
BATTERY.....	PAGE 77
INSTRUMENTS AND WARNING LIGHTS	PAGE 80
LIGHTS.....	PAGE 85
FRONT HEADLAMP	PAGE 92



Maintenance

TECHNICAL INFORMATION

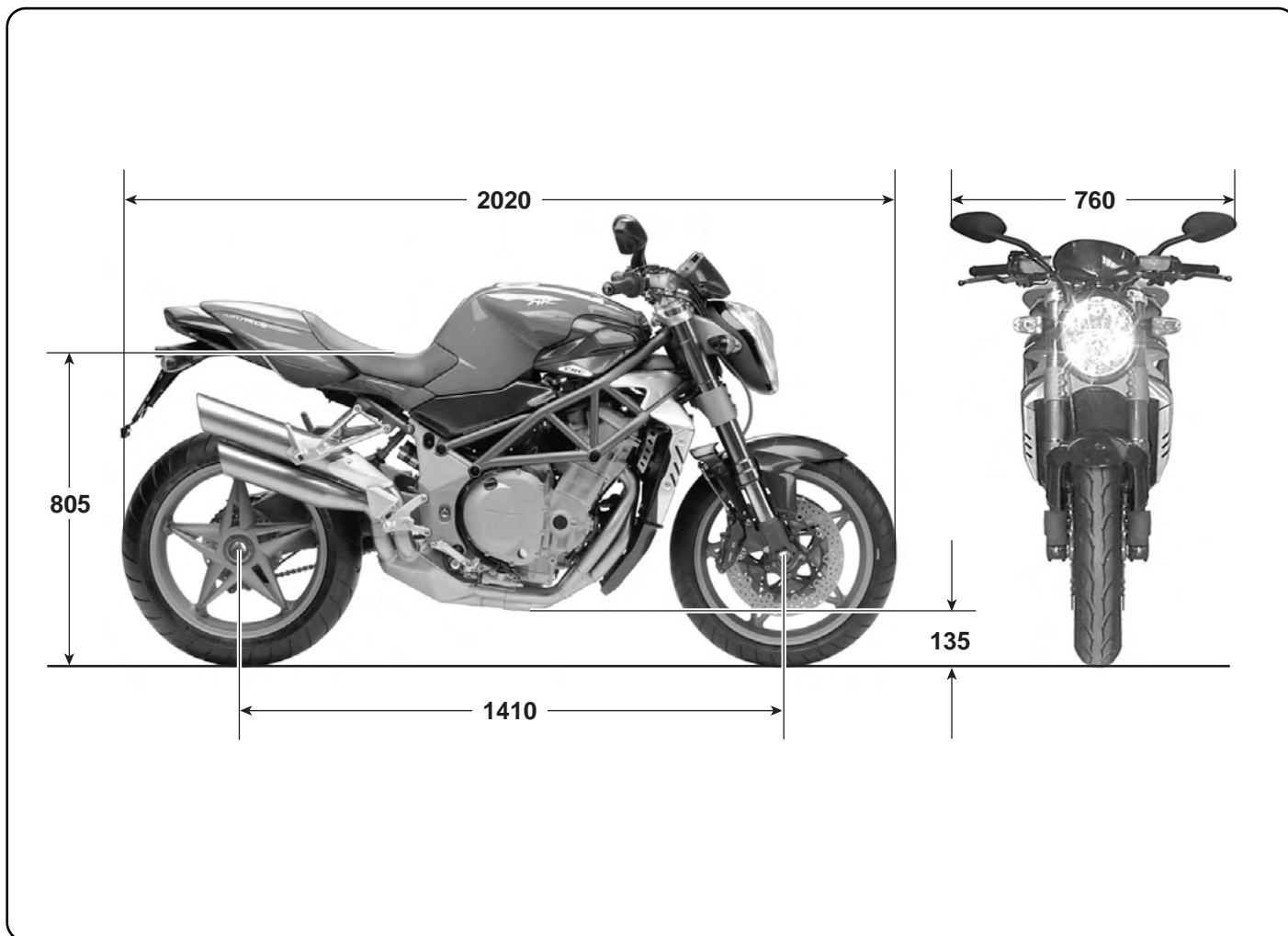

TECHNICAL DATA

Description	BRUTALE ORO	BRUTALE S
CHARACTERISTICS		
Wheelbase (mm) (*)	1410	1410
Total length (mm) (*)	2020	2020
Maximum width (mm)	760	760
Seat height (mm) (*)	805	805
Ground clearance (mm) (*)	135	135
Trail (mm) (*)	101.5	101.5
Dry weight (kg)	179	185
Fuel tank capacity (litres) (**)	19	19
Fuel reserve (litres) (**)	4	4
Sump oil quantity (kg)	3.5	3.5
ENGINE		
Type	4 Stroke four cylinder, 16 valves	
Bore (mm)	73.8	73.8
Stroke (mm)	43.8	43.8
Displacement (cm ³)	749.4	749.4
Compression ratio	12 : 1	12 : 1
Starter system	Electrical	
Cooling	Liquid with oil cooler	
Engine casing and covers	Die-cast	
Cylinder head and cylinders	Chill-cast	
Valves	Bi-metal/mono-metal	

* : I The data declared are not binding. They are susceptible to variations due to riding conditions.

** : I The data declared are not binding. They are susceptible to variations due to external temperature, engine temperature and the evaporation point of the petrol used.



Maintenance

TECHNICAL DATA

Description	BRUTALE ORO		BRUTALE S	
TIMING				
Type	D.O.H.C. radial valves			
LUBRICATION				
Type	Wet sump			
IGNITION – FUEL FEED SYSTEM				
Type	Weber-Marelli ignition/injection 1.6 M integrated system Inductive charge electronic ignition, Multipoint electronic injection			
Spark plugs (alternatively)	NGK CR9 EB	Champion G59c	NGK CR9 EB	Champion G59c
Spark gap (mm)	0.7 ÷ 0.8	0.6 ÷ 0.7	0.7 ÷ 0.8	0.6 ÷ 0.7
CLUTCH				
Type	Wet multi-plate			
PRIMARY TRANSMISSION				
N° teeth - engine crankshaft gear	Z = 47		Z = 47	
N° teeth - clutch gear	Z = 81		Z = 81	
Transmission ratio	1.72		1.72	
SECONDARY TRANSMISSION				
N° teeth – pinion wheel	Z = 14		Z = 14	
N° teeth – crown wheel	Z = 41		Z = 41	
Transmission ratio	2.93		2.93	
GEAR CHANGE				
Type	Extractable six speed, with gearing always inserted			
Gear ratios (total ratios)				
1 st	2.92 (14.71)		2.92 (14.71)	
2 nd	2.21 (11.14)		2.21 (11.14)	
3 rd	1.78 (8.97)		1.78 (8.97)	
4 th	1.50 (7.56)		1.50 (7.56)	
5 th	1.32 (6.65)		1.32 (6.65)	
6 th	1.21 (6.10)		1.21 (6.10)	
FRAME				
Type	Tubular framework in wire-drawn steel tubes 25 CrMo (TIG welding)			
Fork fulcrum plates	Magnesium alloy		Aluminium alloy	
FRONT SUSPENSION				
Type	Hydraulic telescopic forks with the stems positioned upside down, equipped with a system of external adjustment for extension, compression and spring preload			
Ø stems (mm)	50 with titanium nitride treatment		50	
Telescopic movement (mm)	128		128	
REAR SUSPENSION				
Type	Progressive, single-steering damper adjustable in extension, in compression (high/low speed), and in spring-preloading			
Mono-arm fork	Magnesium alloy		Aluminium alloy	
Wheel travel (mm)	120		120	
FRONT BRAKE				
Type	Floating double disk with the braking area in steel			
Ø Discs (mm)	310		310	
Disc flanges	Aluminium		Steel	
Pincers (Ø pistons mm)	6 pistons (Ø 22.65; Ø 25.4; Ø 30.23)			
REAR BRAKE				
Type	Disc type in steel			
Ø Discs (mm)	210		210	
Pincers (Ø pistons mm)	4 pistons (Ø 25.4)			
FRONT WHEEL				
Material	Magnesium alloy		Aluminium alloy	
Dimensions	3.50" x 17"		3.50" x 17"	
REAR WHEEL				
Material	Magnesium alloy		Aluminium alloy	
Dimensions	6.00" x 17"		6.00" x 17"	
TYRES				
Front	120/65-ZR 17 (56 W)			
Rear	190/50-ZR 17 (73 W) o 180/55-ZR 17 (73 W)			
Brand and type	DUNLOP - Sport Max D 207 Race Replica		PIRELLI - Dragon Evo MTR 21 Corsa (Ant.) PIRELLI - Dragon Evo MTR 22 Corsa (Post.) PIRELLI - Diablo Corsa MICHELIN - Pilot Sport MICHELIN - Pilot Power DUNLOP - Sport Max D 207 Race Replica	
Tyre pressures (*)				
Front	2.3 bar (33 psi)		2.3 bar (33 psi)	
Rear	2.3 bar (33 psi)		2.3 bar (33 psi)	

* : In the event of different make tyres being used as opposed to those advised, refer to the pressure values marked on the side of the tyre by the manufacturer.



Maintenance

TECHNICAL DATA

Description	BRUTALE ORO	BRUTALE S
ELECTRICAL SYSTEM		
Voltage	12V	12V
Front dipped beam light bulb	12V 55W	12V 55W
Front main beam light bulb	12V 60W	12V 60W
Front sidelight bulb	12V 5W	12V 5W
Rear light bulb	12V 5W	12V 5W
Rear stop light bulb	12V 21W	12V 21W
Direction indicators	12V 10W	12V 10W
Battery	12V - 9Ah	12V - 9Ah
Alternator	650W a 5000 r.p.m.	650W a 5000 r.p.m.
BODYWORK		
Tank	Thermo-plastic material	Thermo-plastic material
Air filter compartment conveyors	Carbon fibre	Thermo-plastic material
Tank side panel	Carbon fibre	Thermo-plastic material
Tail unit rear side panel	Carbon fibre	Thermo-plastic material
Tail unit	Carbon fibre	Thermo-plastic material
Instrumentation protection	Carbon fibre	Thermo-plastic material
Ignition switch cover	Carbon fibre	Thermo-plastic material
Exhaust tube protection	Carbon fibre	Thermo-plastic material
Chain guard	Carbon fibre	Thermo-plastic material
Oil cooler protection	Carbon fibre	Thermo-plastic material
Number plate carrier	Thermo-plastic material	Thermo-plastic material
Rear-view mirrors	Thermo-plastic material	Thermo-plastic material
Protezione tubo scarico	Aluminium	Aluminium



★ COMPONENTS IN CARBON FIBRE (F4 BRUTALE ORO)

- 1 - Right air filter compartment side panel
- 2 - Left air filter compartment side panel
- 3 - Right tank side panel
- 4 - Left tank side panel
- 5 - Right cylinder cover
- 6 - Left cylinder cover
- 7 - Instrument panel protection
- 8 - Ignition switch cover
- 9 - Tail unit
- 10 - Front mudguard
- 11 - Top chain protection
- 12 - Lower chain protection
- 13 - Oil cooler protection

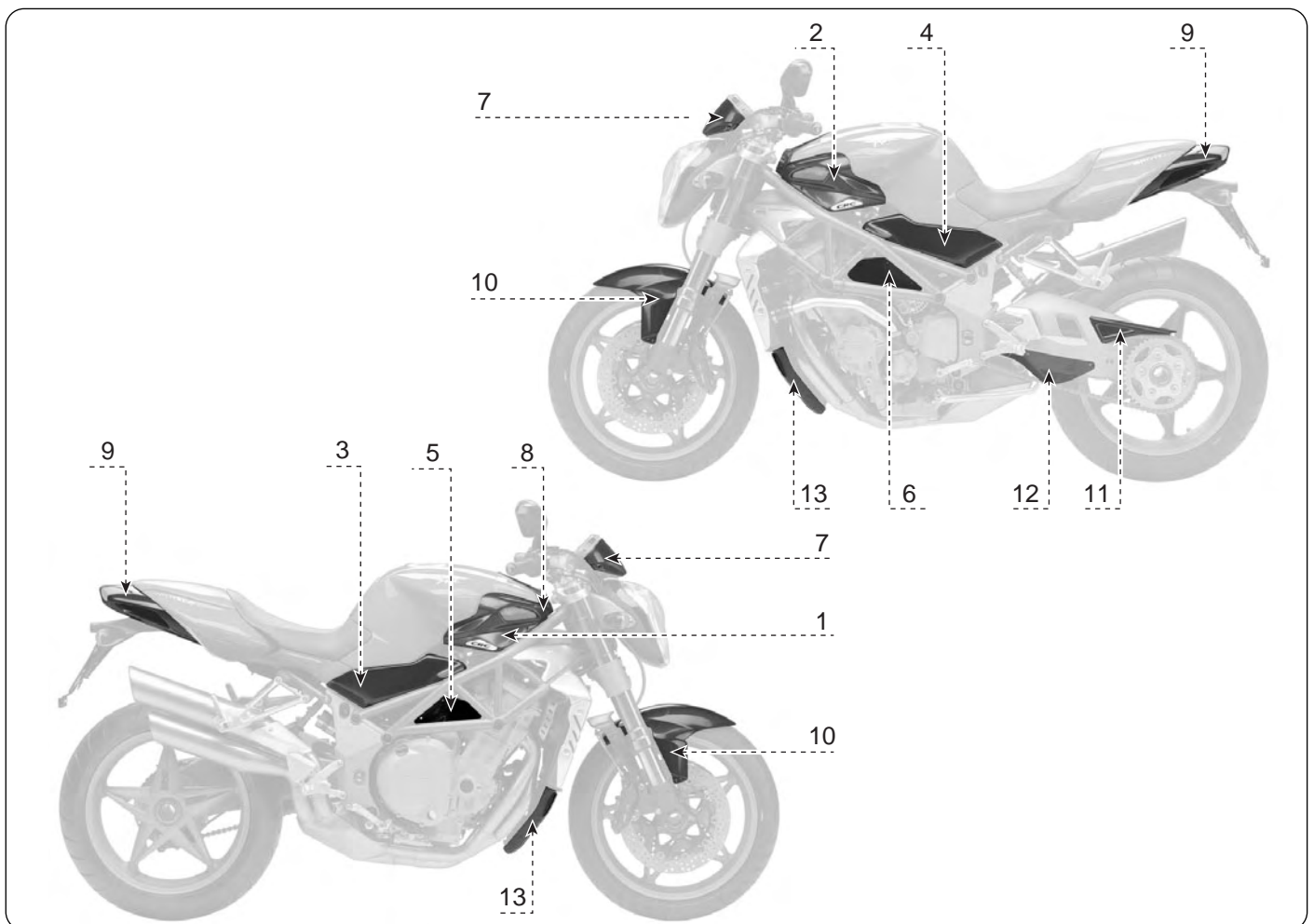



★ MAGNESIUM COMPONENTS (F4 BRUTALE ORO)

- 1 - Steering base
- 2 - Frame side plate
- 3 - Front wheel rim
- 4 - Rear wheel rim
- 5 - Mono-arm fork

B

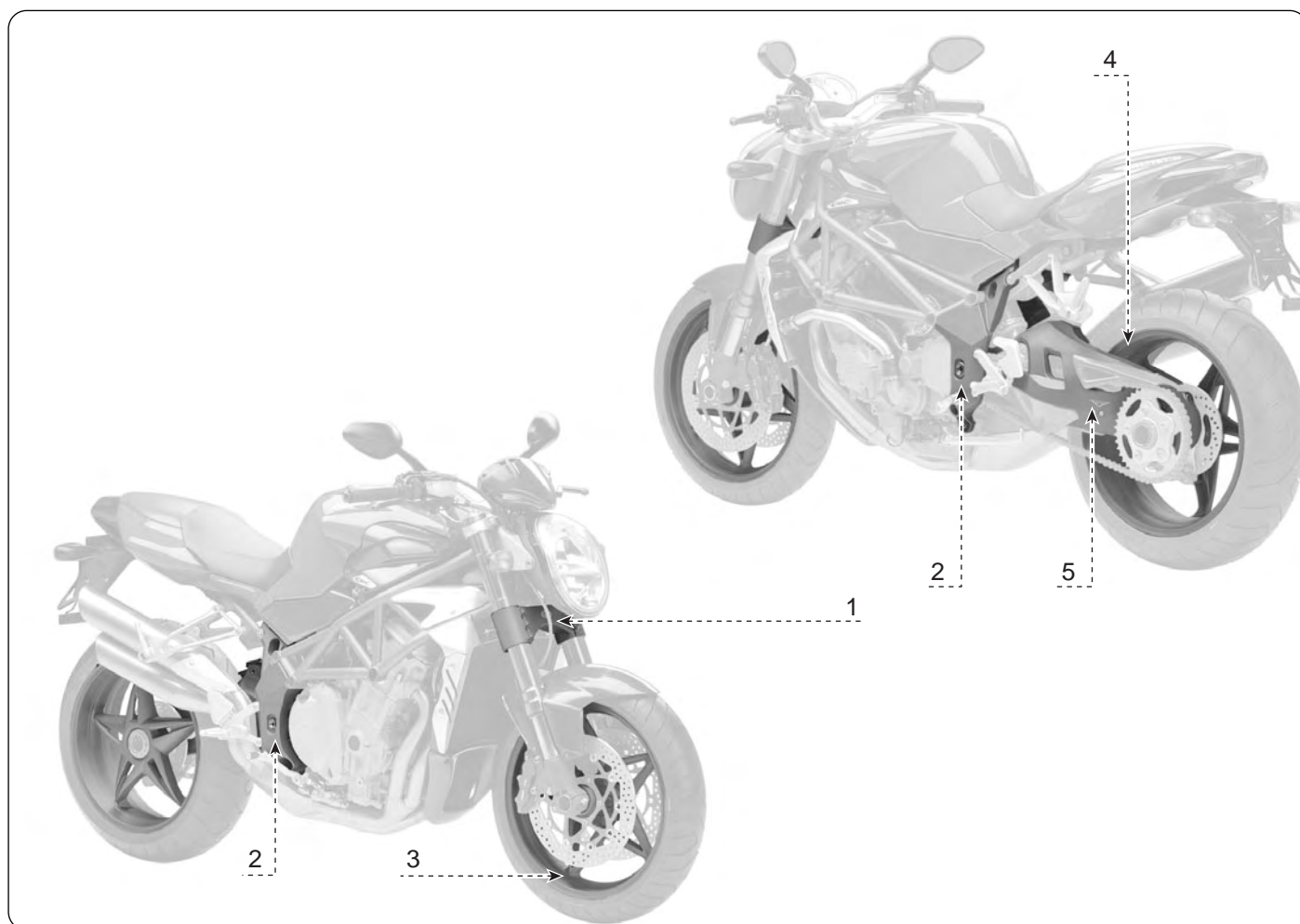



Maintenance

B



Maintenance

PERIODICAL MAINTENANCE SCHEDULE



The following table shows the recommended intervals for the interventions of periodical maintenance. Periodical maintenance is necessary to keep the motorcycle in an optimum condition. The intervals are expressed in kilometres.

 **WARNING** For motorcycles used in particularly severe conditions, maintenance operations must be carried out more frequently.

 **We respect and defend the environment.** Everything that we do has repercussions on the whole planet and on its resources. MV Agusta, to protect the interests of the everyone, ask clients and technical assistance operators to use the motorcycle and dispose of its used parts with respect to the norms in force in terms of environmental pollution, disposal and recycling of refuse.

★ **The information marked with this symbol refers only to the F4 BRUTALE model series ORO.**







Programmed maintenance schedule

Km (mi) covered		0	1000 (600)	6000 (3800)	12000 (7500)	18000 (11200)	24000 (14900)	30000 (18600)	36000 (22400)
Service		Pre-delivery	A	B	C	D	E	F	G
Description	Operation								
Engine oil	Substitution		●	●	●	●	●	●	●
		At least once a year							
Engine oil filter 	Substitution (Utilise only originali MV Agusta oil filters)		●	●	●	●	●	●	●
		At every substitution of engine oil							
Engine coolant	Check level and top-up	●	●	●	●	●	●	●	●
	Substitution	At least every two years							
Cooling system	Check for leakages	●	●	●	●	●	●	●	●
Electric fan	Check functioning	●	●	●	●	●	●	●	●
Valves 	Check / adjustment		●		●		●		●
Timing chain	Check		●		●		●		●
	Substitution								●
Mobile timing chain guide	Check / Substitution		●		●		●		●
	Substitution	At least every substitution of the timing chain							
Timing chain tensioner	Check / Substitution				●		●		●
Spark plugs	Check / Substitution		●	●		●		●	
	Substitution				●		●		●
Fuel filter	Check / Substitution				●		●		●
Throttle body 	Check and adjust		●	●	●	●	●	●	●
Air filter	Check / Substitution			●	●	●	●	●	●
Brake and clutch fluid	Check level	●	●	●	●	●		●	●
	Substitution						●		
		At least every two years							
Brakes and clutch	Check functioning	●	●	●	●	●	●	●	●
	Check circuit	●	●	●	●	●	●	●	●
	Cleaning of contact lever / pump piston area	●	●	●	●	●	●	●	●
Brake pads (front and rear)	Check / Substitution		●	●	●	●	●	●	●
Fuel tubes	Check for defects and leakages		●	●	●	●	●	●	●
	Substitution	At least every three years							
Accelerator control	Check functioning	●	●	●	●	●	●	●	●
	Check/adjust play	●	●	●	●	●	●	●	●
Starter control	Check functioning	●	●	●	●	●	●	●	●



Manutenzione

Programmed maintenance schedule

Km (mi) covered		0	1000 (600)	6000 (3800)	12000 (7500)	18000 (11200)	24000 (14900)	30000 (18600)	36000 (22400)
Service		Pre-delivery	A	B	C	D	E	F	G
Description	Operation								
Transmission and flexible controls	Check / Adjust	●	●	●	●	●	●	●	●
	Check / Adjust	●	●	●	●	●	●	●	●
Transmission chain 	Lubricate		●	●		●	●	●	●
	Substitution			★	★●	★	★●	★	★●
Pinion wheel/stop washer	Check		●	●		●		●	
	Substitution			★	★●	★	★●	★	★●
At least at each substitution of the transmission chain									
Crown wheel	Check		●	●		●		●	
	Substitution			★	★●	★	★●	★	★●
At least at each substitution of the transmission chain									
Crown wheel tension regulator	Check			★	★●	★	★●	★	★●
Steering head flange ring 	Check / Adjust		●		●		●		●
Steering bearings 	Check / Adjust		●		●		●		●
	Lubricate						●		
Tyres	Check for pressure	●	●	●	●	●	●	●	●
	Check for wear		●	●	●	●	●	●	●
Wheel rims	Visual check		●	●	●	●	●	●	●
		Every tyre substitution							
Front wheel bearings 	Check			●	●	●	●	●	
	Every tyre substitution								
Parts in magnesium	Visual check for knocks and scratches		★	★	★	★	★	★	★
		★ At least every six months							
Side stand	Check functioning	●	●	●	●	●	●	●	●
Side stand switch 	Check functioning	●	●	●	●	●	●	●	●
	Cleaning of contact lever area with side stand	●	●	●	●	●	●	●	●
Rear wheel hub	Check / lubricate roller bearings and guides				●		●		
	Substitution / lubricate roller bearings and guide								●
Rear fork bearings	Check / lubricate								●
Rear fork chain guide	Check / substitution		●	●	●	●	●	●	●
Chain guide frame plate	Check / substitution		●	●	●	●	●	●	●
Rear shock absorber	Check / Adjust		●		●		●		●
Front fork oil 	Substitution						●		
Battery connections	Check and clean		●	●	●	●	●	●	●
Electrical system	Check functioning	●	●	●	●	●	●	●	●
Instrument	Check functioning	●	●	●	●	●	●	●	●
Lights/visual signals	Check functioning	●	●	●	●	●	●	●	●
Horn	Check functioning	●	●	●	●	●	●	●	●
Front headlight	Check functioning	●	●	●	●	●	●	●	●
	Adjust	At every variation of the riding set-up of the motorcycle							
Ignition switch	Check functioning	●	●	●	●	●	●	●	●
Locks	Check functioning	●	●	●	●	●	●	●	●
Torque settings – nuts and bolt	Check / tightness	●	●	●	●	●	●	●	●
Tube band fasteners 	Check / tightness	●	●	●	●	●	●	●	●
General lubrication		●	●	●	●	●	●	●	●
General check		●	●	●	●	●	●	●	●



Maintenance

Table of lubricants and fluids

Description	Recommended product	Specification
Engine oil	AGIP RACING 4T 10W/60 (*)	SAE 10W/60 - API SJ
Engine coolant	AGIP ECO - PERMANENT	Ethylene-glycol diluted with 40% distilled water
Brake and clutch fluid	AGIP BRAKE FLUID DOT4	DOT4
Chain lubrication oil	MOTUL CHAIN LUBE PLUS	-

* : To find the recommended product, MV Agusta suggests going directly to the authorised MV Agusta dealers. AGIP Racing 4T 10W/60 has been manufactured for the F4 engine. If the described oil is not available, MV Agusta suggests using completely synthetic oils with characteristics that conform or exceed the following norms:

- Conforming to API SJ
- Conforming to ACEA A3
- Conforming to JASO MA
- Grade SAE 20 W-50 o 10 W-60

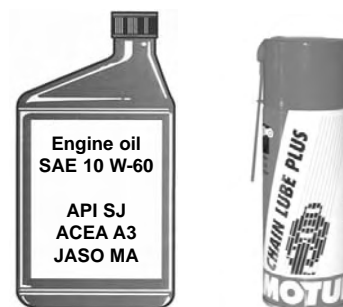

N.B.

The above specifications indicated are marked either on their own or together with others on the container of the lubricating oil.

MAINTENANCE AND TUNING OPERATIONS

Each operation of periodical maintenance is described in this chapter.

ENGINE OIL AND OIL FILTER

Engine oil

Substitute:→ at the first 1000 kilometres and then every 6000 kilometres

Oil filter

Substitute:→ at the first 1000 kilometres and then every 6000 kilometres (or at least every oil change)



To accede to the oil filter and the discharge and filling holes of the engine oil, it is necessary to carry out certain operations beforehand:

- n Place the motorcycle on the rear stand.

N.B.

The substitution of the engine oil must be done with a hot engine as opposed to the oil-check that is done with a cold engine.

Place a container underneath the engine to collect the used oil.

Remove the oil discharge plug (1).

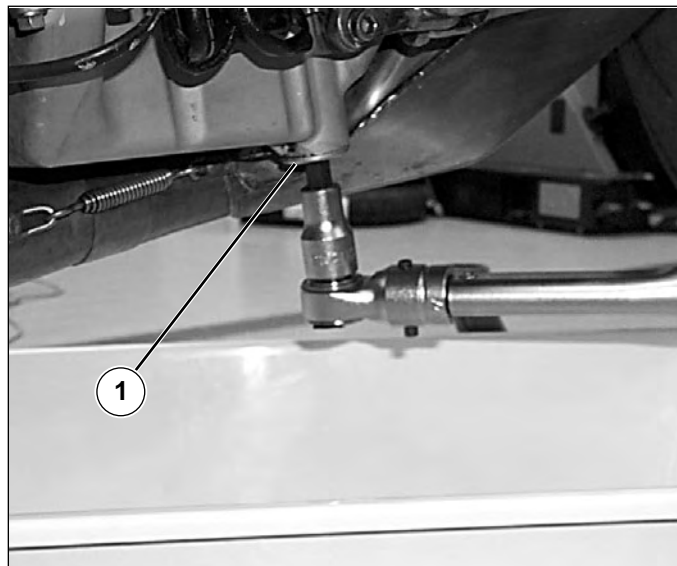

Recover the oil in an appropriate container. Do not scatter the drainage oil into the environment.



Maintenance

Remove the oil filler plug (1) on the right side of the motorcycle so that it facilitates the discharge of the used oil.

Wait until the lubrication system is completely empty of used engine oil.

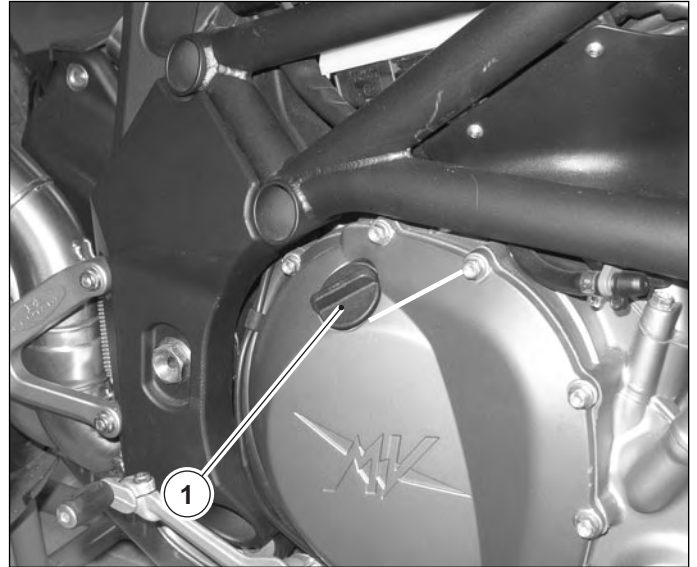

Substitution of the oil filter

In order to proceed to replace the oil filter you should remove the exhaust manifolds of the cylinders 3 and 4.

Release the two side clamps of the oil cooler.

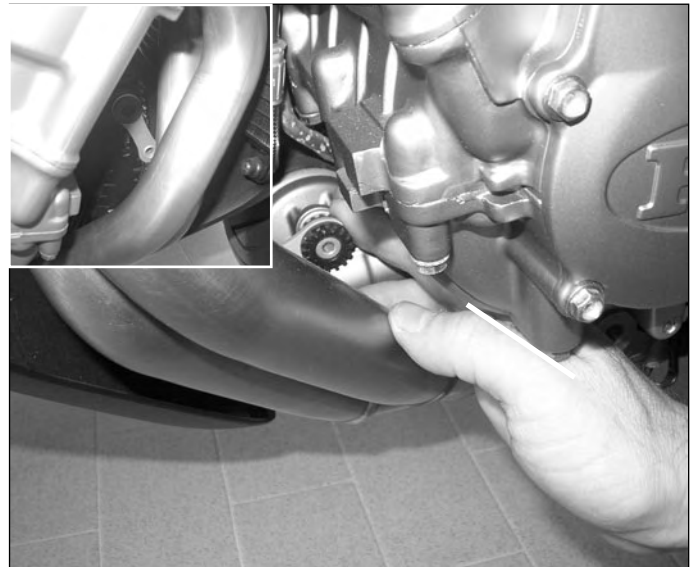

Unscrew the lower fixing screws of the oil cooler protection on the lower basis of the water radiator. Remove the oil cooler protection.





Maintenance

Slightly move the coolers towards the front area of the motorcycle, then unscrew the nut on the fixing flange of the exhaust manifolds of the cylinder group.



During this operation pay attention to the exhaust pipes in order to avoid from scorching.

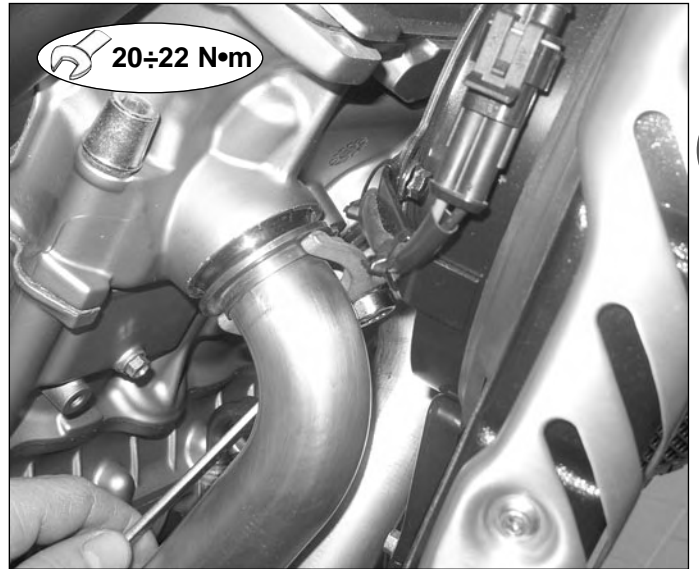

Release the union spring between compensator and manifolds of cylinders 3 and 4.

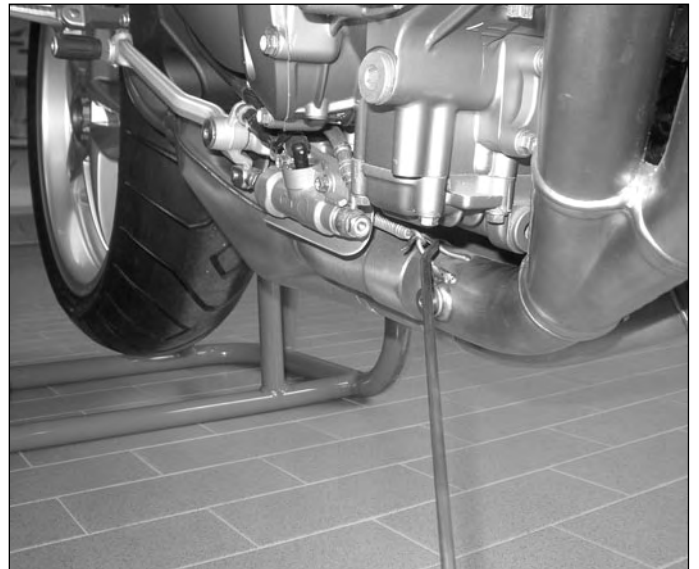

Remove the manifold of cylinders 3 and 4.

N.B.

In order to facilitate the reassembly of the manifolds you should place the fixing flange on the manifolds before these manifolds are placed on the engine. Insert the flange in the manifolds and then turn it.

Place the flange-manifolds assembly on the fixing stud, then tighten the check nut to the torque wrench shown.



Torque wrench of exhaust manifold check nut: 20÷22 Nm

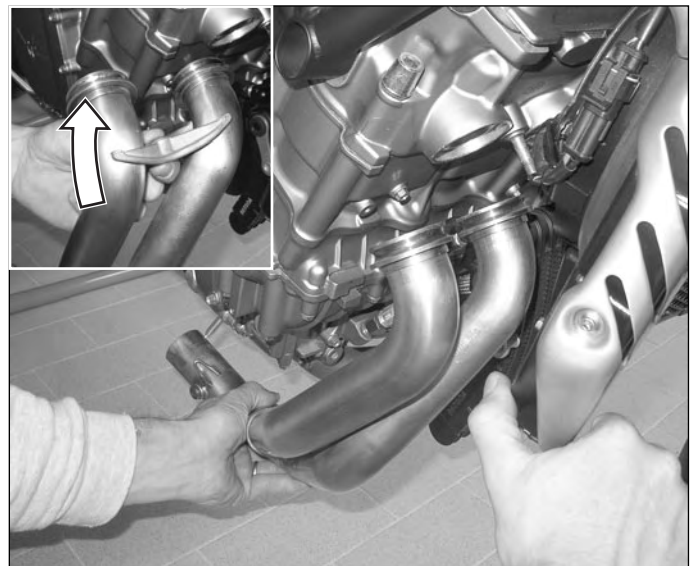

Loosen the safety clamp and remove it.

B



Unscrew the oil filter by an appropriate wrench.

In the event of a filter branded TOYO ROKI use the wrench for oil filter:



TOYO ROKI
FACOM D. 139 tool
Part code 8000A4317

In the event of a filter branded Champion use the wrench for oil filter:



Champion
Part code N° 800099010

Clean accurately any oily parts.



Using a clean cloth to clean accurately the area and the filter face.





Maintenance

Take out the oil filter from the new engine oil filter kit.

- Toyo Roki oil filter kit: Part code 8000A3702
- Champion oil filter kit: Part code 8000A1428

 **Only use original components of MV Agusta.**



If you use an oil filter Toyo Roki (Part code 8000A3702), you should the following preliminary operation.

Take out the gasket from the engine oil filter kit of new equipment and insert on the filter as shown in the figure on the left.

 **Only use a new gasket.**

Slide the gasket up to bring in contact with the oil filter back ring (see figure on the right).



Lubricate the gasket on the filter with engine oil.



Insert the filter in its seat.

Turn the filter manually until the gasket is into slight contact with the machined surface.

B

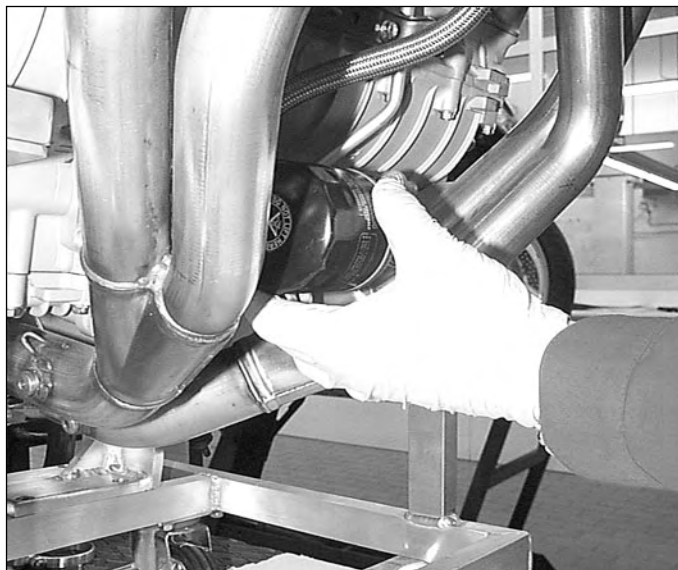

Tighten the filter using the appropriate tool and a torque wrench.

- TOYO ROKI oil filter:

 **FACOM D. 139 tool**
Part code 8000A4317

 **Oil filter torque wrench:**
24 N·m

- Champion oil filter:

 **Tool code 800099010**

 **Oil filter torque wrench:**
15 N·m

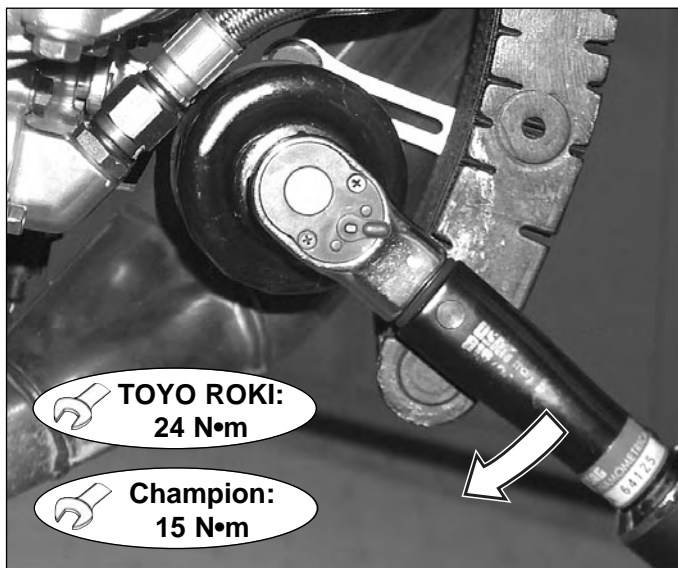

After having tightened the filter, take out the clamp for engine oil filter and its screw from the new oil filter kit.

 **Only use a new clamp.**

Insert the clamp and slide it until it brings in contact with the oil filter back ring.





Maintenance

Place the clamp lock at a range of **2 mm** from the screwhead on the supporting plate of oil cooler pipes.

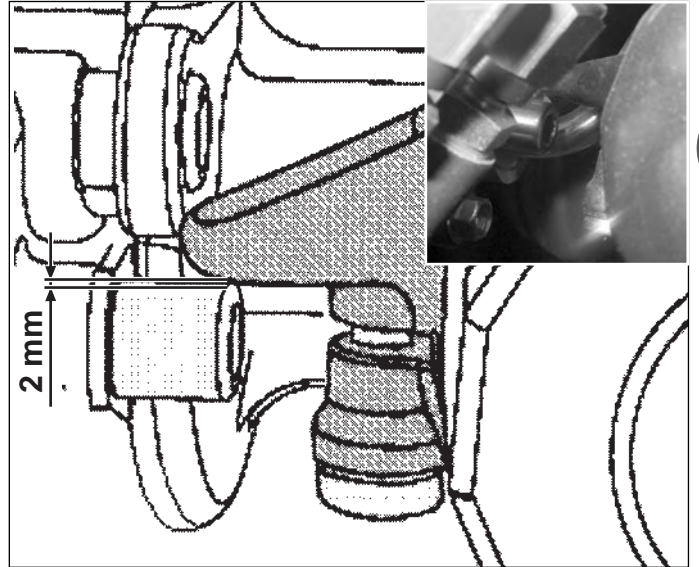

Turn the clamp screw up to bring in contact with the filter without tightening.

Mark the screw position drawing a line by a felt-tip both on the screw and on the clamp.

Make the last tightening of the screw getting it perform 2 turns and 1/4 further the position marked previously.

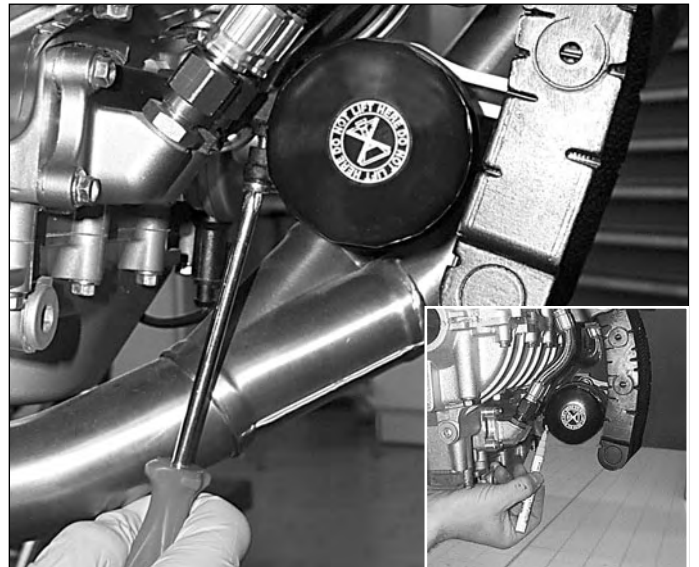

Once completed the assembly, ensure that the clamp lock of the engine oil filter is at a range between **1 and 1.5 mm** from the screwhead on the supporting plate of oil cooler pipes. Check any leakages from oil filter.

Mark the position of the definite tightening of the screw using a felt pen, both on the filter and the band fastener. Trace a reference mark also on the band fastener and the relative screw, with the object of eventually checking any slackening of the screw.



Do not use the oil filter as a point of grip or contact.

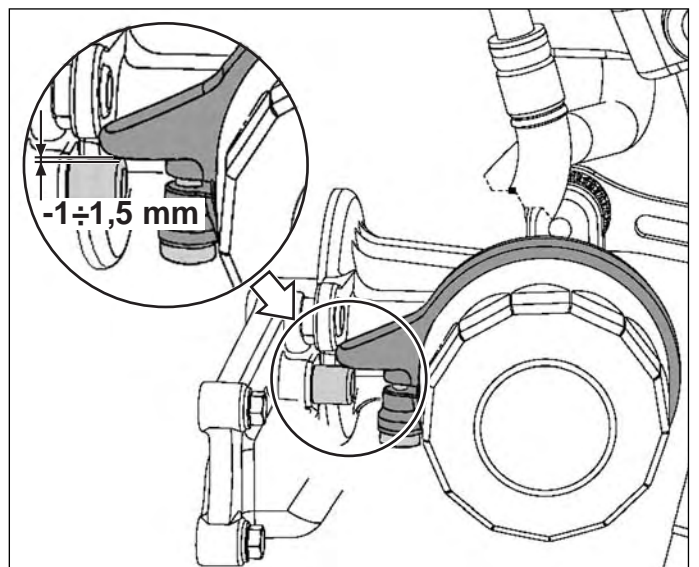



Maintenance

On the oil discharge plug there is a magnet to attract any metal residues that could form in the engine during rotation.

Before proceeding with the reassembly of the plug, check that the cleaning has been done thoroughly and also the condition of the gasket seal.

Screw in the oil discharge plug and tighten it to the specified torque.



Torque pressure – oil discharge plug: 35 N·m

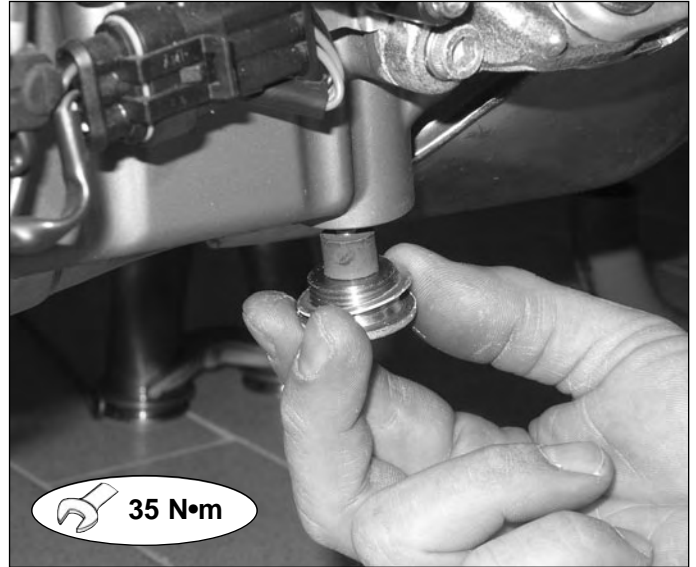

Pour approximately 3 litres of engine oil (in according to the type specified in table on page 11 in this chapter) into the oil filler hole of the engine.

Close the filler hole using the appropriate cap.

Switch on the engine for several minutes.

After switching off the engine, wait at least ten minutes and then check the oil level. Ensure that the motorcycle is placed on level ground and is in a vertical position.

The correct level must be as close as possible to the "MAX" mark shown on the engine casing. Do not surpass this limit.

Check any oil leakages.



Avoid turning the engine over with the oil level lower than minimum. It could compromise the correct functioning of the engine. If the level after the topping-up, is over the "MAX" reference notch, correct it by emptying a little oil out of the engine.

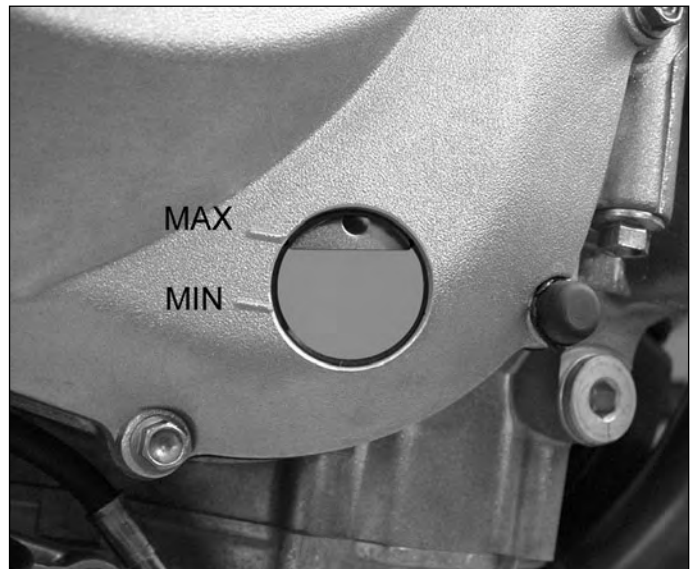

Oil tubes

During normal maintenance procedures check the correct assembly of components and check for blow-bys or oil leaks from the engine parts.

In particular:

- Blow-bys at the base of the engine.
- Oil filter support
- Oil pump-engine cylinder head delivery tubing.



When oil leaks are identified, even small ones, proceed with the overhaul of components as described in the F4 workshop engine manual (Code 8000 A1592).

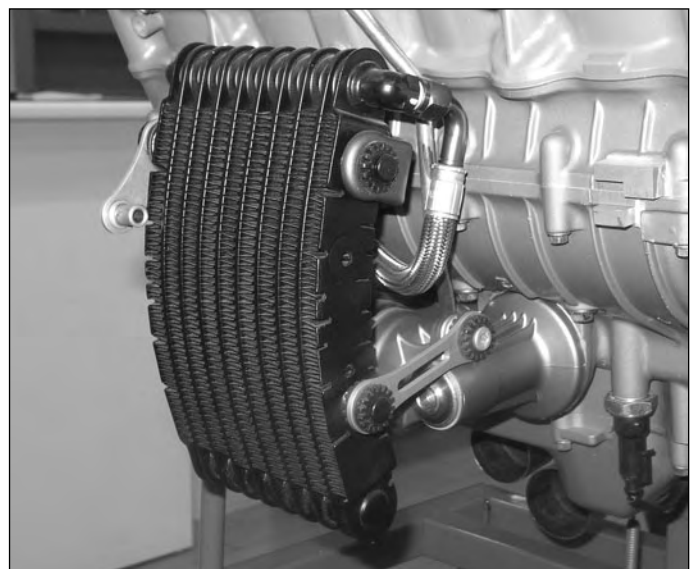



ENGINE COOLANT

Check/top-up level →

At the pre-delivery, at the first 1000 kilometres and then every 6000 kilometres

Keeping the motorcycle in a vertical position, check that the level of engine coolant is between the «MIN» mark found on the expansion tank (1) and the lower part of the frame tube, that you can see from the opening on the frame protection panel on the left side of the motorcycle.



If the level is under the minimum line, proceed with top-ping-up as follows:

- Remove the two fixing screws (2) of the ignition switch cover (3).
- Extract the cover.

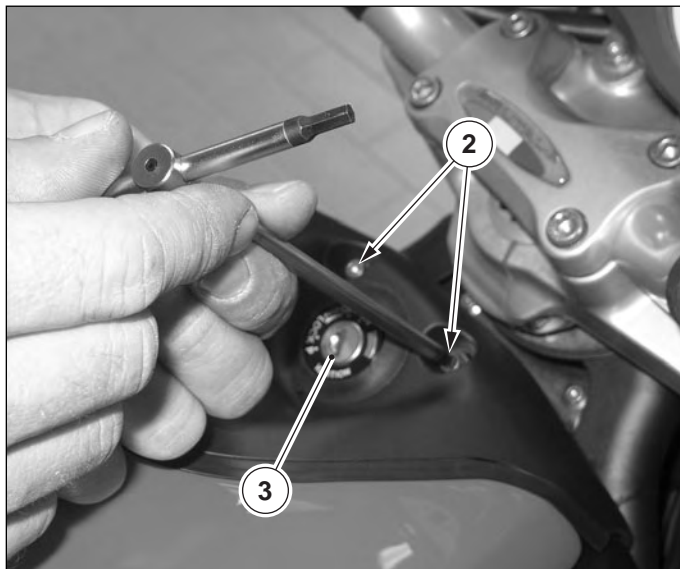

With the engine cold, top up the level using the filler hole (4) of the expansion tank.



Open the expansion tank only when the engine is cold; the discharge of boiling liquid could cause burns.

If the liquid comes into contact with the skin or the eyes, rinse abundantly with water.



Engine coolant substitution

Substitution → Every two years

B Before proceeding the emptying of the system, Perform the following operations in advance:

- Remove the ignition switch cover (see “Engine coolant level check”);
- Place a container under the engine to collect the used coolant;
- Open the expansion tank cap;
- Remove the coolant discharge screw (1) situated on the coolant pump (2), thereby letting the coolant flow out.

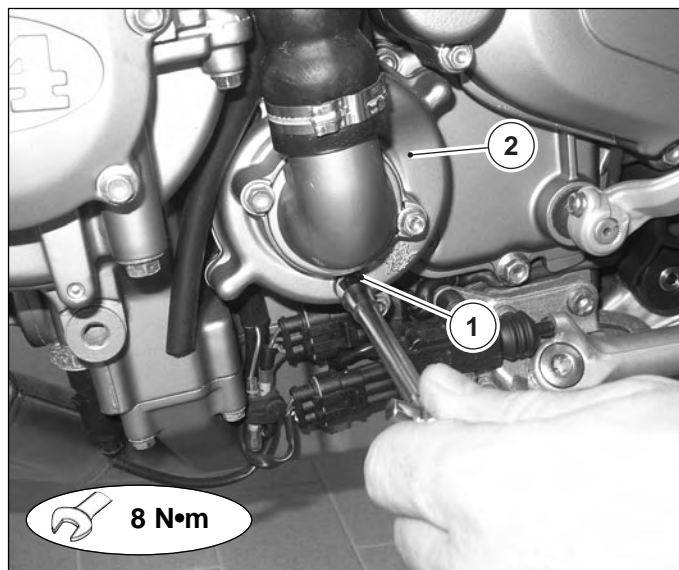

Wait for the engine coolant to completely flow out.

Collect the engine coolant in an appropriate container. Do not scatter the engine coolant into the environment.



Tighten the engine coolant discharge plug (1) to the specified torque, after having checked the condition of the gasket.

Torque pressure, engine coolant discharge plug : 8 N•m

Fill the cooling system with the appropriate liquid described in table (see page 11 of this chapter) until the level is between the «MIN» mark found on the expansion tank and the lower part of the frame tube (see figure below).

Close the cap.

Switch on the engine and keep it running until the water becomes hot enough to automatically switch on the electric cooling fan. Switch off the engine. Wait some minutes for the engine to cool down.

Carefully check for leaks, blow-bys, damaged tubing, etc. If there are leaks or damage in the cooling system, proceed with the overhaul as described in the chapter “Cooling system”.



Check once again the level of the coolant inside the expansion tank (3).

It should be between the «MIN» mark found on the expansion tank and the lower part of the frame tube, as shown in the figure.

If the level is inferior to the «MIN» mark, top up the coolant level by pouring new coolant into the filler hole.





Complete the assembly of the motorcycle.



B

ELECTRIC COOLING FAN

Check → on pre-delivery and at the first 1000 kilometres and then every 6000 kilometres

To carry out the check on the functioning of the electric cooling fan, switch on the engine and heat it up.

The electric fan should come into operation when the instrument panel shows a system temperature of about 100 °C. If the electric cooling fan does not switch on, carry out the checks on the various components as described in chapter L “Cooling system”.





VALVE MECHANISM ADJUSTMENT

Check and adjust → at 1000 kilometres and every 12000 kilometres

B Remove in order the following components to carry out the measuring of the play between the camshaft and the valve cups:

- Passenger seat
- Rider seat
- Left tank side panel
- Right tank side panel
- Ignition switch cover
- Fuel tank
- Air filter compartment
- Throttle body

N.B.: For all removal operations, including the relative attention notes, please refer to the specific sections in this manual.

An analogous reference is utilised for the reassembly of the parts after the maintenance operation.

After having removed the indicated components, the motorcycle is shown in the condition described by the photograph on the left.

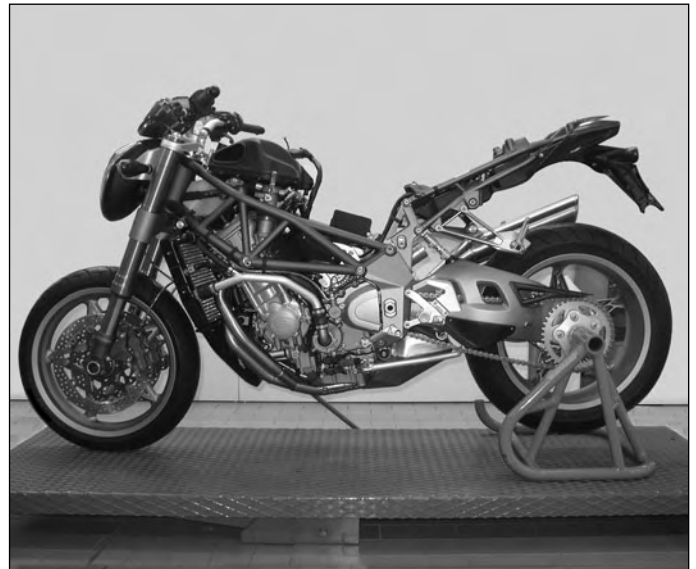

Before proceeding with the various maintenance operations, it is advisable to thoroughly wash and clean the motorcycle.

Place the motorcycle (now without the components listed above and clean) on a workstation as indicated in the figure.

Apply adhesive paper tape to the frame tubes.

This operation will protect the paintwork from knocks, scratches and abrasions that could occur during the work activity.

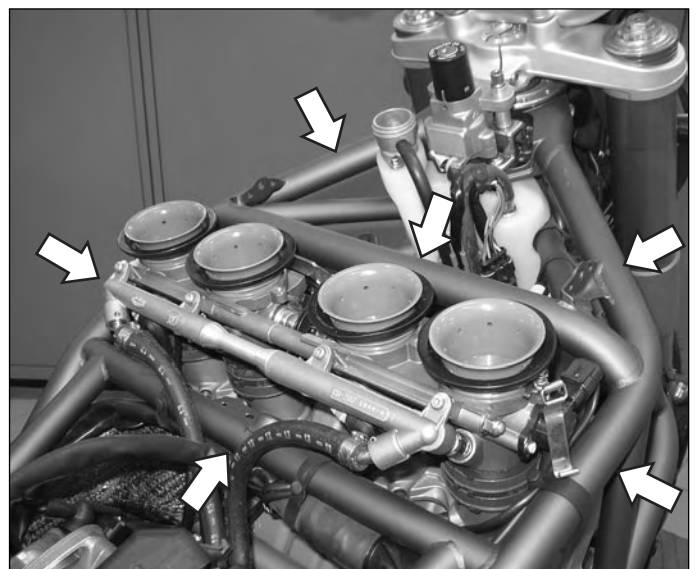



Maintenance

Ensure that all the surfaces of the frame are protected by the application of the adhesive tape.

Apply the same adhesive tape to the air intakes of the engine.

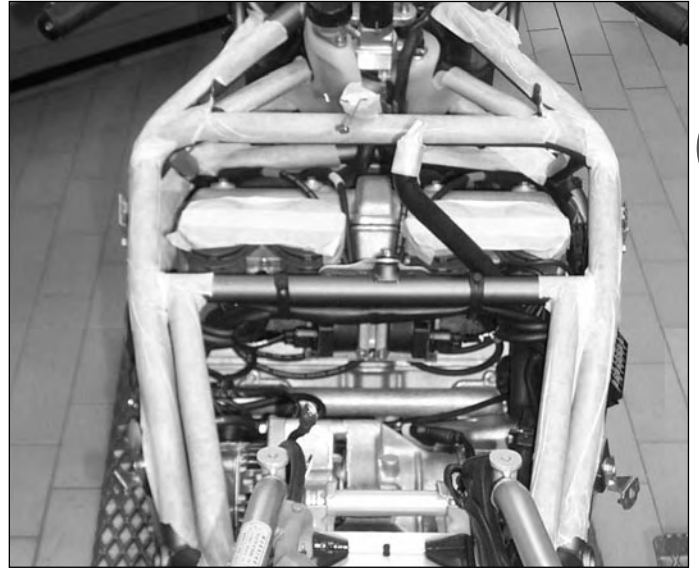

Apply adhesive tape also on the oil breather tube (A) and on the terminals of the accelerator control (B).

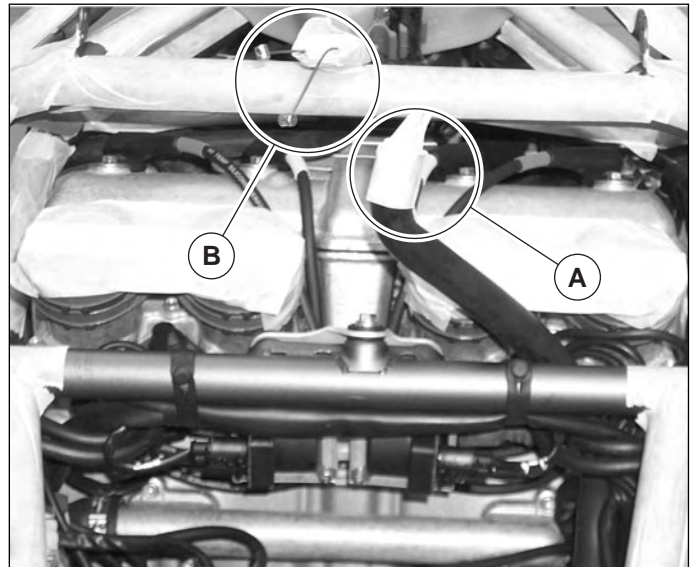

Pull out the connectors of the coils.
In order to perform this operation, release the secondary lock (yellow tongue) pulling out from its seat, then press the black tongue and release the connector.





Maintenance

Unscrew the earth bonding on the engine head cover and release the coil harness from the frame removing the two clamps, and extract it on the right side.

B



Unscrew the fixing screws of the coil plates, and remove them.
Pull out the coils from their seat.



Screw and remove the eight fixing bolts of the cylinder head cover.





Maintenance

Operating as shown in the figure, slightly lift up the cylinder head cover.

To carry out this operation, use only the work surfaces indicated.

Take care to not ruin or deteriorate the motorcycle parts in the proximity of the work area.

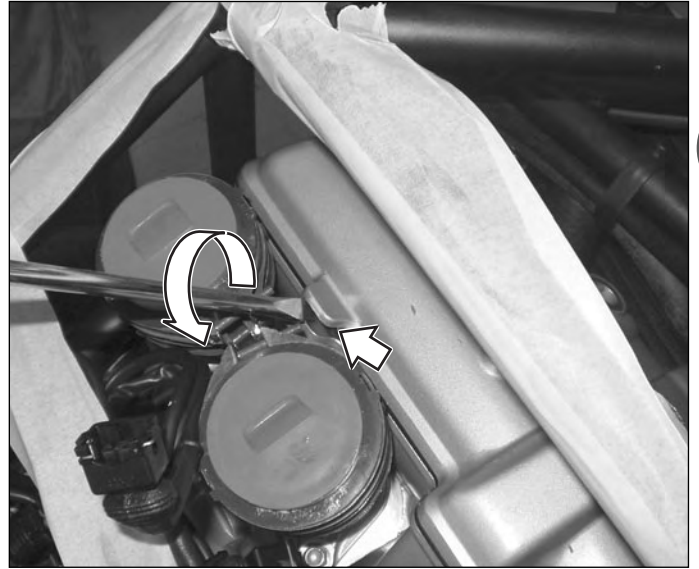

Proceed with the removal of the cylinder head cover.

To facilitate this operation, it is advisable to move the rubber engine coolant filling tube situated on the left side of the motorcycle.

Complete the removal of the cylinder head cover by sliding it towards the rear part of the motorcycle.



Remove the head cover gasket.

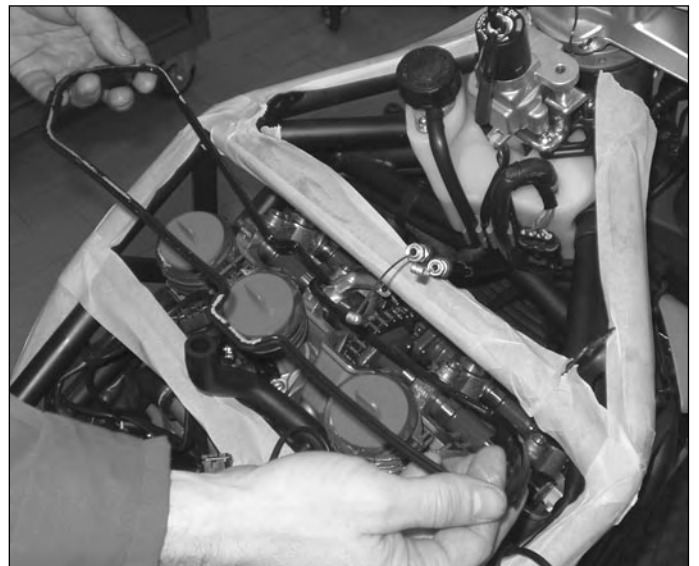

Utilising a syringe, remove the surplus oil that is left in the various niches in proximity to the valve cups.

B



Proceed with the removal of the timing wheel cover by unscrewing the five fixing screws.



Rotate the camshaft by turning the central nut in an anti-clockwise direction to bring piston N° 1 of the engine to the Top Dead Centre position (T.D.C.) when the piston is at its uppermost part of the compression stroke.

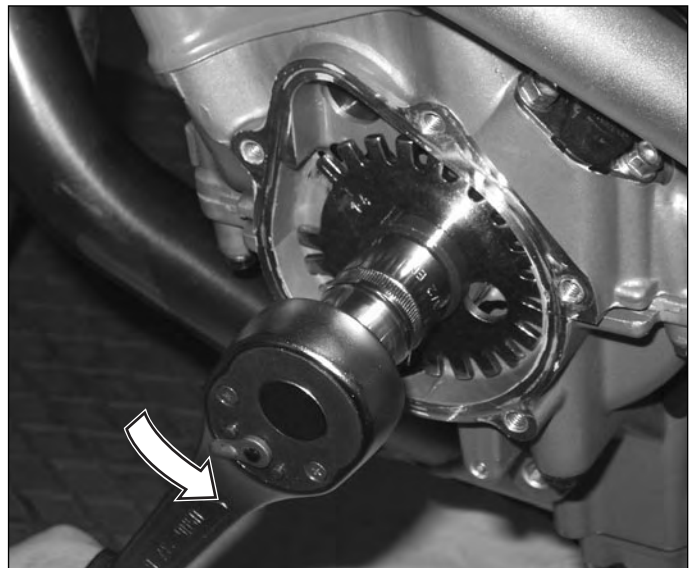



Maintenance

Check the timing of the engine by ensuring that the incision stamped on tooth (A) of the timing wheel is in line with the "tooth" (B) that is present on the engine casing.

The following photograph illustrates clearly the correct position.

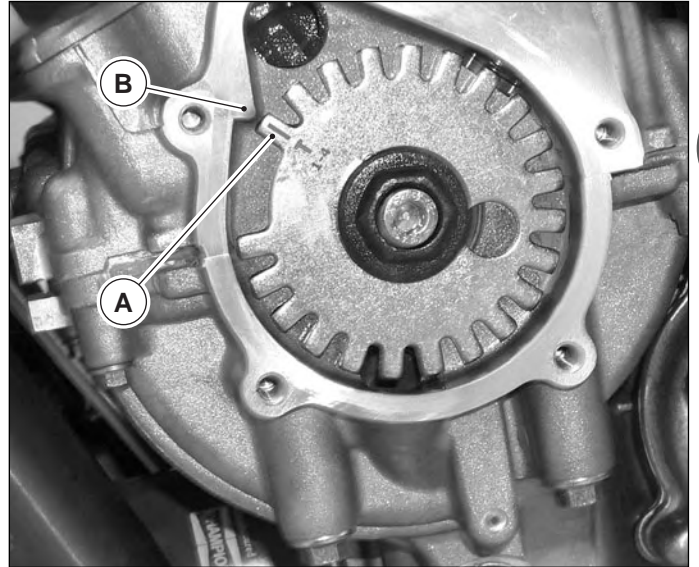

The position of the timing wheel is clearly seen in the enlargement in respect of the mark on the engine casing. Also the marks present on the toothed wheels of the camshaft must be aligned together when the timing wheel is in this position.

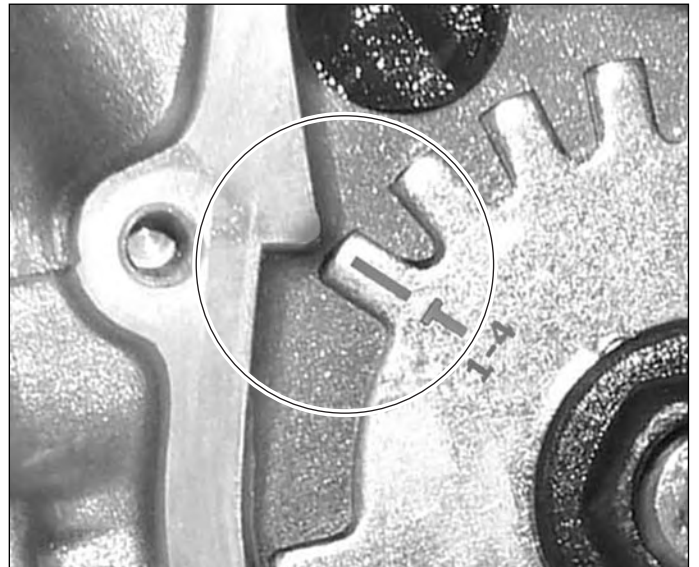

Utilising a feeler gauge of the type shown in the figure, measure the play between the camshaft and the valve cups.





Maintenance

Continue measuring the play as illustrated in the figure.

B



The correct measuring of the play is a fundamental operation for the correct functioning of the engine.





Maintenance

Carry out the measuring of the play of the following valves:

Cylinders 1 and 2 intake valves (number° 1,2,3,4)

Cylinders 1 and 3 exhaust valve (number 11,12,15,16).

Scrupulously, make a note of the order of the values measured in the form of a table.



For example, here is a hypothesis of a table in which are written the various values measured.

Date	Vehicle	Engine registration n°	Frame registration n°	Kilometres travelled
------	---------	------------------------	-----------------------	----------------------

Values measured before substituting the valve cups:

	CYLINDER 1		CYLINDER 2		CYLINDER 3		CYLINDER 4	
INDUCTION	Valve n° 1	Valve n° 2	Valve n° 3	Valve n° 4	Valve n° 5	Valve n° 6	Valve n° 7	Valve n° 8
Valve play								
Pad thickness								

	CYLINDER 1		CYLINDER 2		CYLINDER 3		CYLINDER 4	
EXHAUST	Valve n° 16	Valve n° 15	Valve n° 14	Valve n° 13	Valve n° 12	Valve n° 11	Valve n° 10	Valve n° 9
Valve play								
Pad thickness								

Values measured after having replaced adjusting pins:

	CYLINDER 1		CYLINDER 2		CYLINDER 3		CYLINDER 4	
INDUCTION	Valve n° 1	Valve n° 2	Valve n° 3	Valve n° 4	Valve n° 5	Valve n° 6	Valve n° 7	Valve n° 8
Valve play								
Pad thickness								

	CYLINDER 1		CYLINDER 2		CYLINDER 3		CYLINDER 4	
EXHAUST	Valve n° 16	Valve n° 15	Valve n° 14	Valve n° 13	Valve n° 12	Valve n° 11	Valve n° 10	Valve n° 9
Valve play								
Pad thickness								



Maintenance

The progressive numeration of each valve is illustrated in the photograph on the right.

Note the anti-clockwise direction of the numeration.

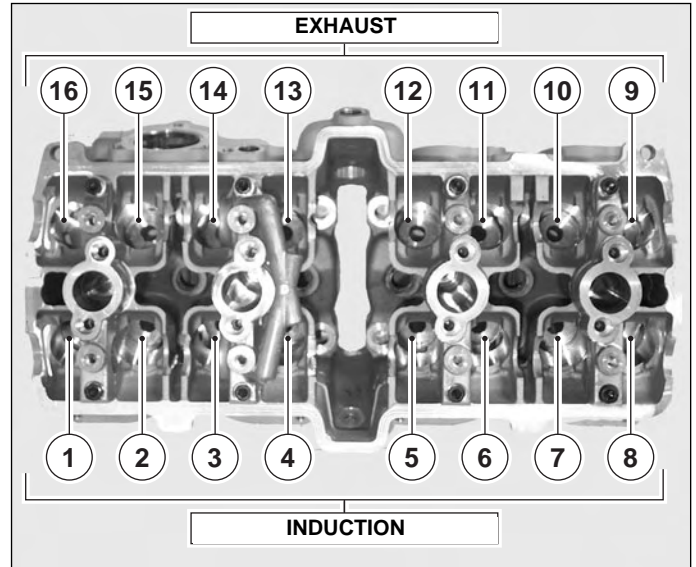

To facilitate the operation, it is possible to note beforehand and in order the play values revealed on the strip of adhesive tape applied to the openings of the air intake conduits.

These must anyway also be written in the table previously illustrated.

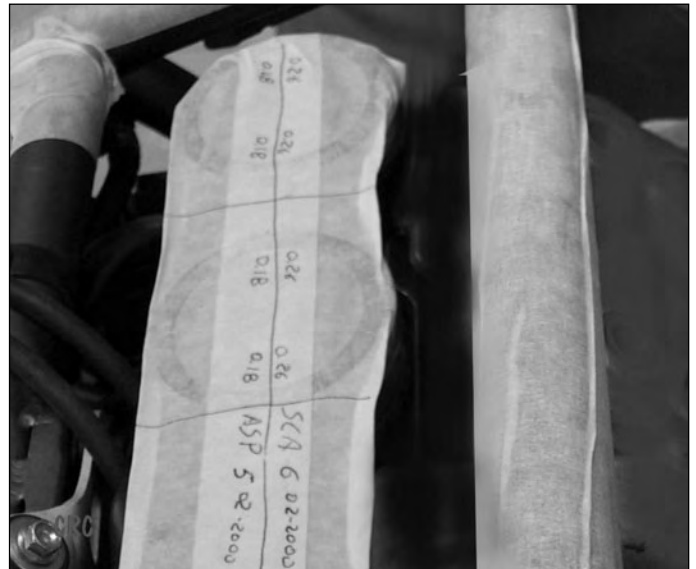

Rotate the crankshaft 360° by turning the central nut.

The rotation of the crankshaft must always be done in an anti-clockwise direction.

The operation just described is completed when piston n° 4 is in the Top Dead Centre position (T.D.C.) of the compression stroke.

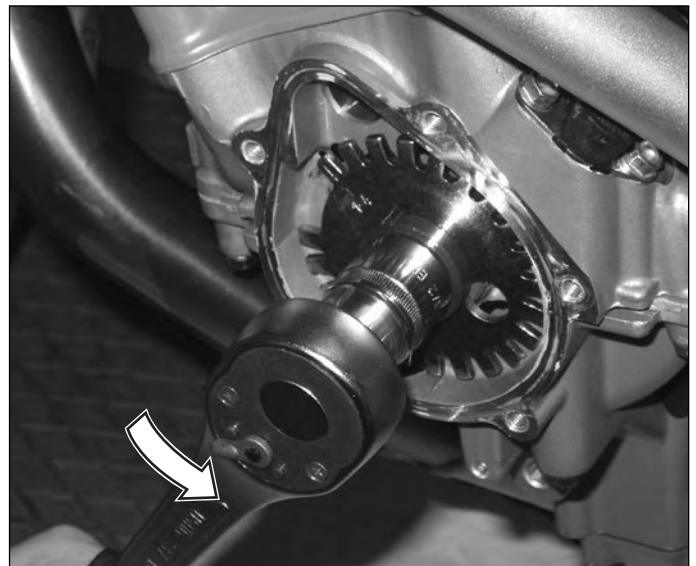



Maintenance

Check again the timing of the engine, ensuring that the incision stamped on the timing wheel is aligned with the “tooth” on the engine casing.

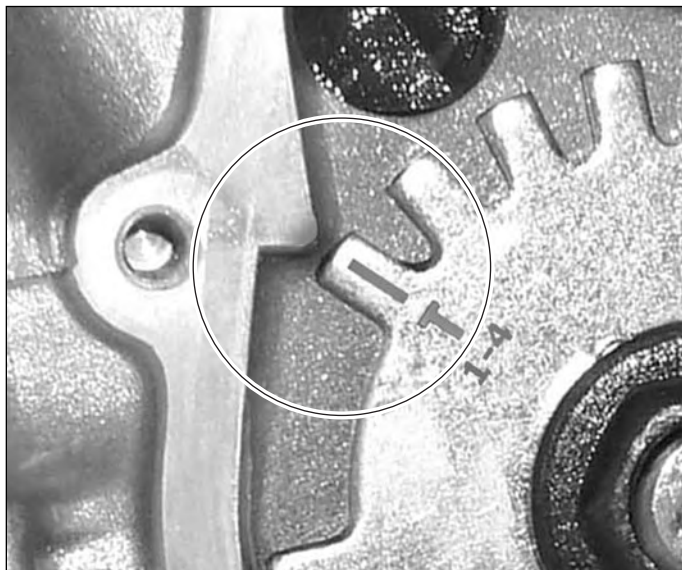

Continue with the measuring of the play of the following valves:

Cylinders 3 and 4 intake valves (n° 5,6,7,8)

Cylinders 2 and 4 exhaust valves (n° 9,10,13,14).

Make a note of the measured values ensuring that they are scrupulously written in the correct order of the previously illustrated table.



B

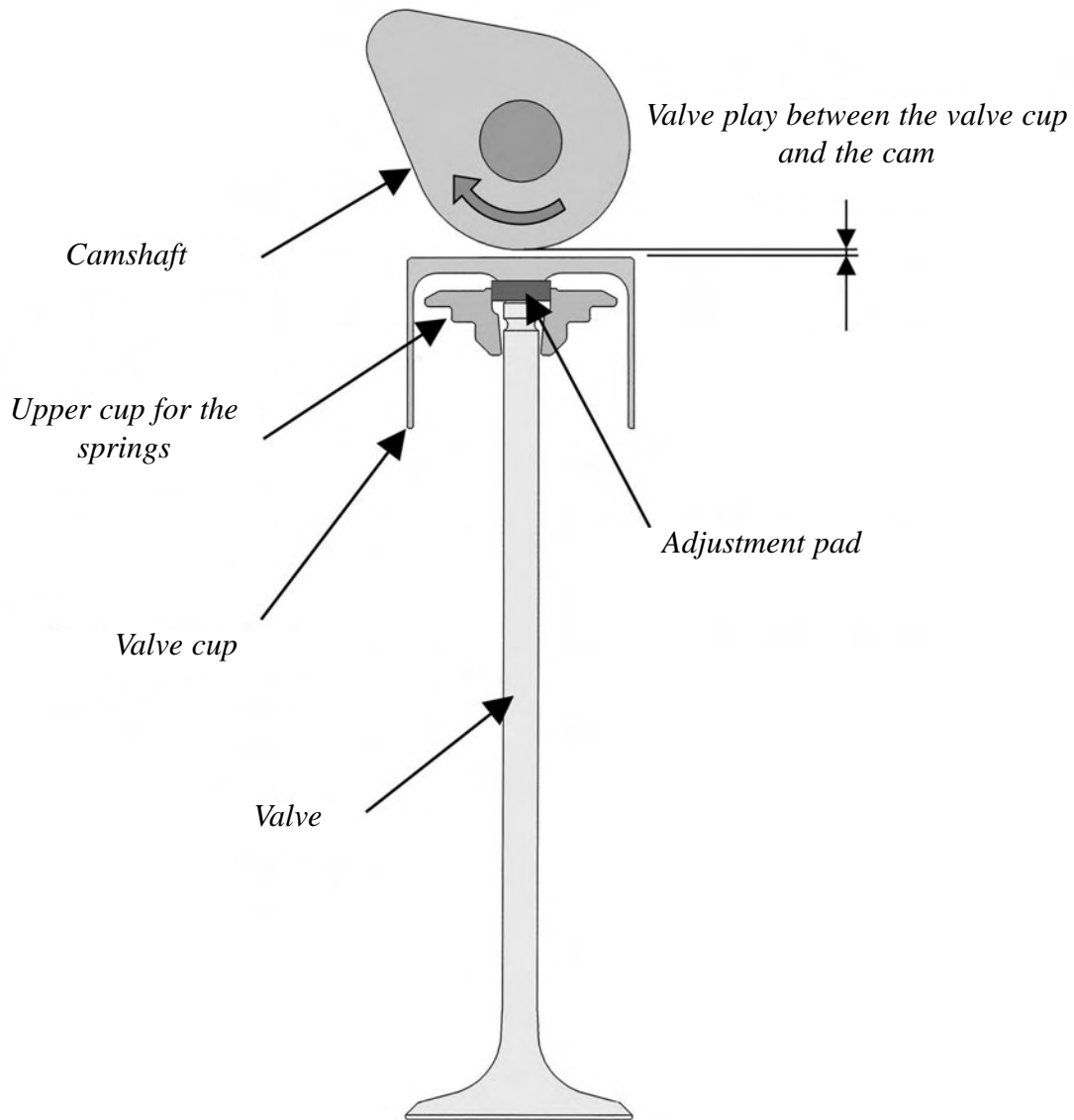

The play values measured between the valve cup and cam must be the following:

For all intake valves $0,15 \div 0,24$ mm

For all exhaust valves $0,20 \div 0,29$ mm

If different values are encountered even for one valve, substitute the camshaft/valve cup play adjustment pads as described in the F4 workshop engine manual (Code 8000A1592).

If the values are correct, reassemble in reverse order to disassembly. Consult the F4 workshop engine manual (Code 8000A1592) for the specific torque pressures and the necessary products.

Before proceed to reassemble the engine head cover, it is recommended to clean accurately the residues of dope along the seal form on the head and use a new gasket.





Timing chain, mobile timing chain guide and timing chain tensioner

Timing chain and mobile timing chain guide:

Check → First 1000 kilometres and then every 12000 kilometres

Substitute → Every 36000 kilometres

Timing chain tensioner:

Check/substitute → Every 12000 kilometres

To disassemble these parts and not being a part of normal maintenance, it is necessary to proceed as described in the overhaul section of the F4 workshop engine manual (Part code 8000A1592).

SPARK PLUGS

Check/substitute → First 1000 kilometres, at 6000 kilometres and then every 12000 kilometres

Substitute → Every 12000 kilometres

The following components must be removed to accede to the spark plugs:

- Passenger seat
- Rider seat
- Fianchetto laterale sx
- Right side panel
- Fuel tank
- Air filter compartment

Proceed to pull out 4 coils as described above. Remove the spark plugs utilising the appropriate 16 mm hexagonal spark plug spanner.

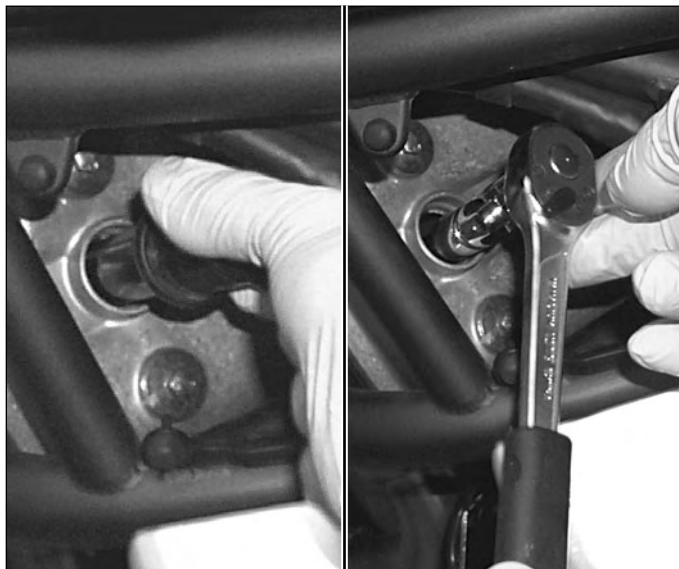

Heat Grade

Check the heat grade of the spark plugs.

Spark plug gap

Measure the gap between the electrodes of the spark plug with a feeler gauge. Adjust this gap in compliance with the values written in the table below.

Spark plugs (alternatively)	electrode distance "A" (mm)
NGK CR9 EB	0.7 ÷ 0.8
Champion G59c	0.6 ÷ 0.7

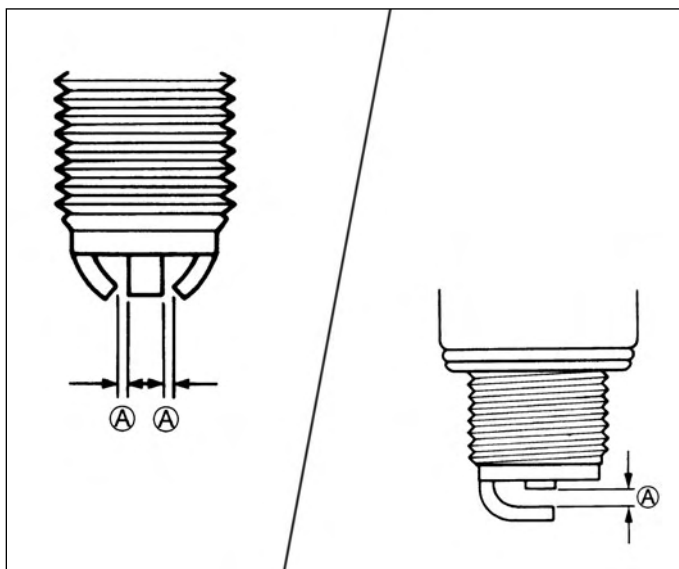

Electrode condition

Check the electrodes for wear or burning. If they are extremely used or burnt, substitute the spark plugs. Also substitute the spark plugs in the case of breakage of the ceramic isolation or damage to threading.



When the spark plugs are renewed, check the thread pitch size and the length of the thread. If the threading is too short, carbon deposits will be placed on the threading of the cylinder head plughole thereby risking damage to the engine.

Manually insert the spark plugs into their seats to avoid damage to the threading of the cylinder head. When completely screwed in by hand, tighten to the specified torque pressure.



Spark plugs torque pressure: 12 N·m

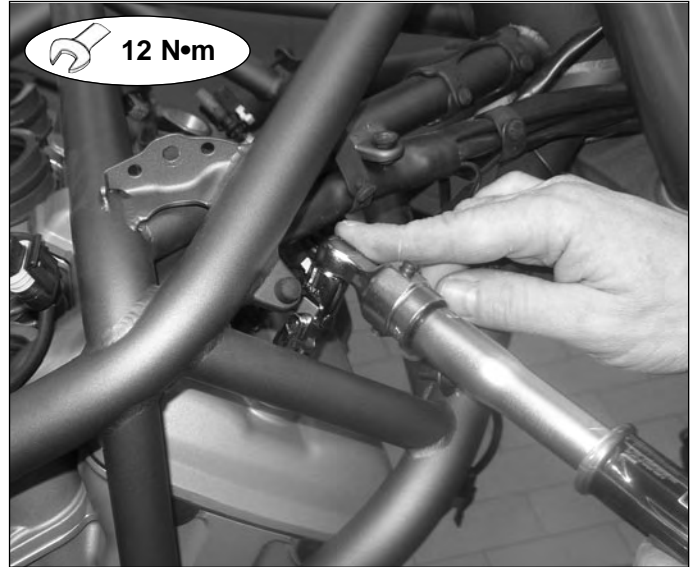

FUEL FILTERS

Check and substitute → Every 12000 km

For the checking or substitution of the engine intake system filters (fuel filter, fuel pump filter), it is necessary to remove in sequence the following parts:

- Passenger seat
- Rider seat
- Ignition commutator cover
- The side panels
- Fuel tank

N.B.: In order to perform the above-mentioned operations, refer to the chapter C “Superstructures”.

Carry out the following operation.

Drain completely the fuel tank using a booster pump as shown in the figure.





Petrol flange assembly removal

Close the tank filler cap.
Invert the tank and remove nine fixing screws (1) for fixing the flange to the tank.

Remove the flange assembly (2) from its seat.

To pull out the flange (2) use three M6 screws (1) removed previously.
Insert the screws (1) into the respective threaded holes.
Screw in sequence until the flange is extracted.

Lift up the flange (1) and disconnect the tubes (2) on both sides of the flange.
Remove the two CLIC R 96105 fasteners utilising the specified pincers.



Specified pincers: CLIC R 205
Part code 800095850

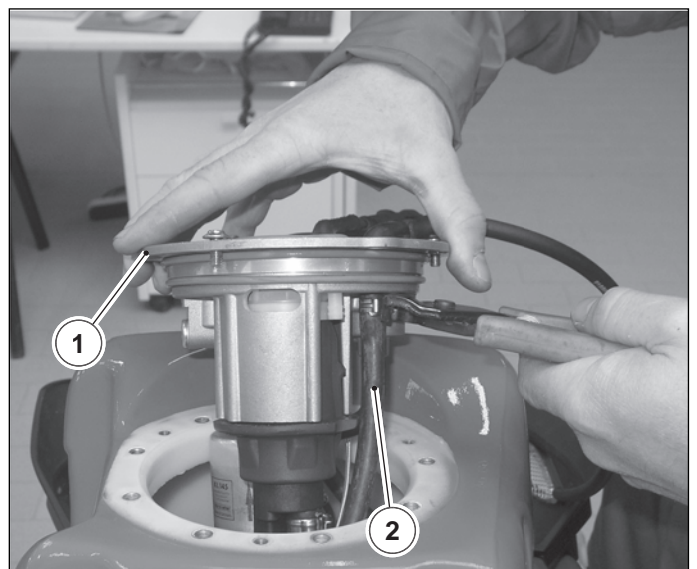
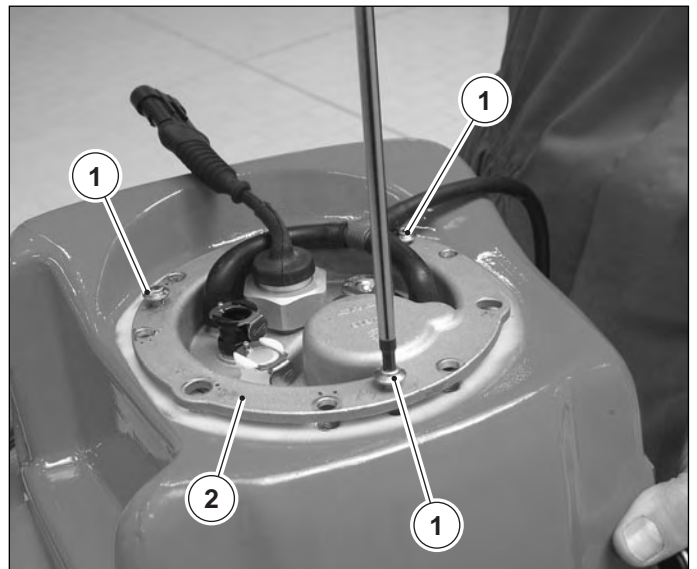
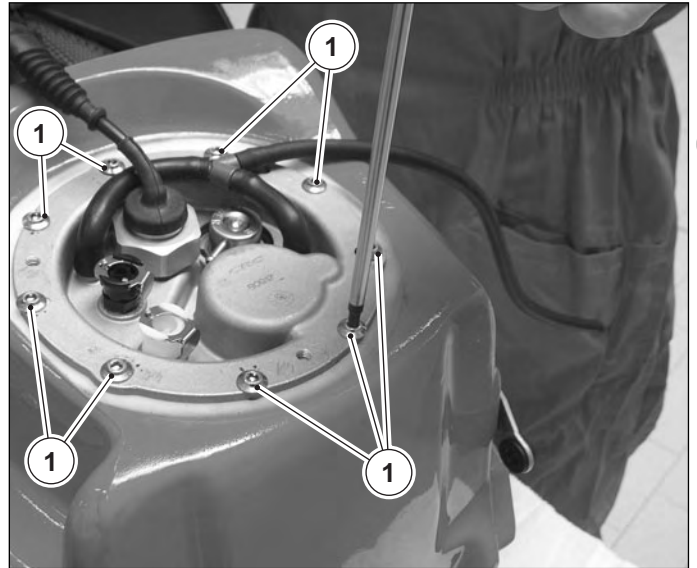



Extract the complete flange assembly (1).

B



Remove the sealing O-rings (1) of the flange (2) and clean them accurately. Check they are undamaged. If damaged, replace them with new rings.

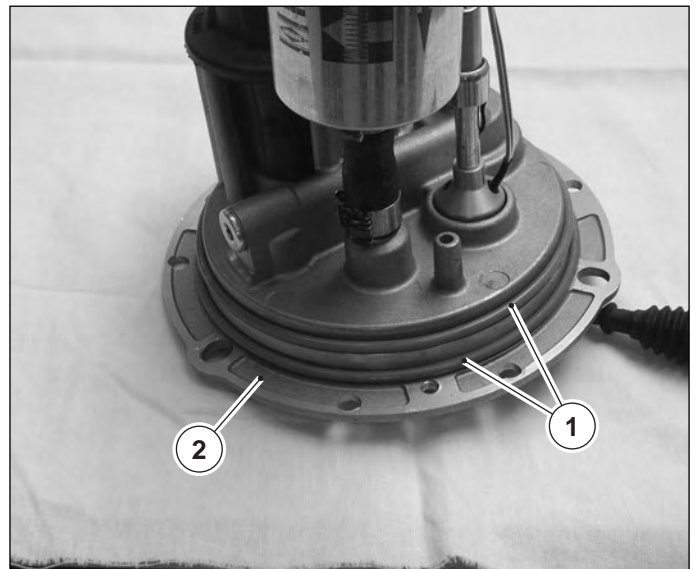

Disconnect the electric connectors of the fuel pump (1).





Maintenance

Remove the fuel probe by using a tube spanner on the fixing nut of the probe.

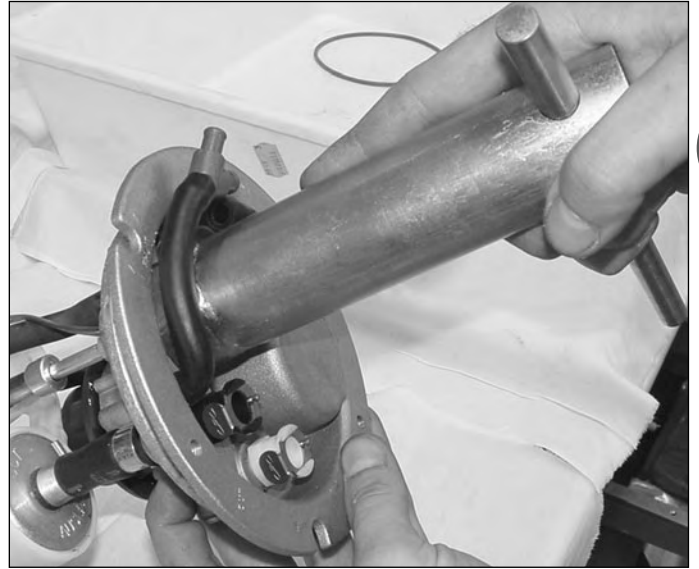

Remove the closing screw (1) of the conduit indicated in the figure so that the remaining fuel flows out of the conduit.

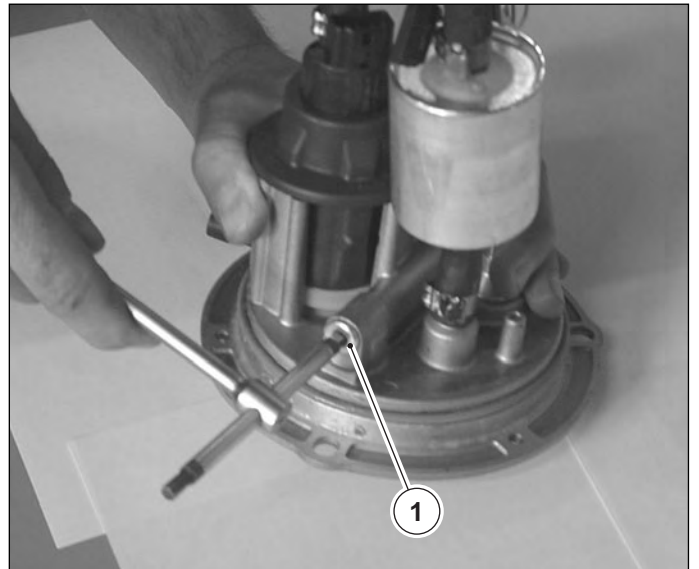

Remove the two CLIC R 96135 fasteners (1), placed on top of the fuel filter.

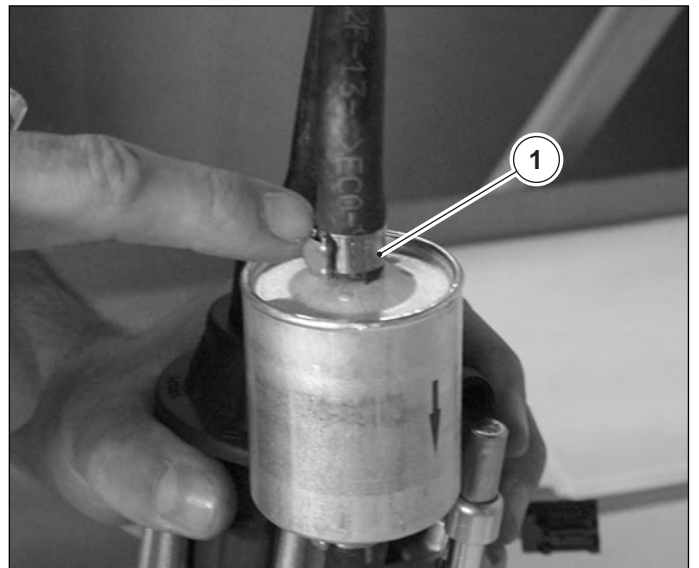

Operate as indicated in the preceding figure and remove the CLIC R 96135 fastener (1).

B

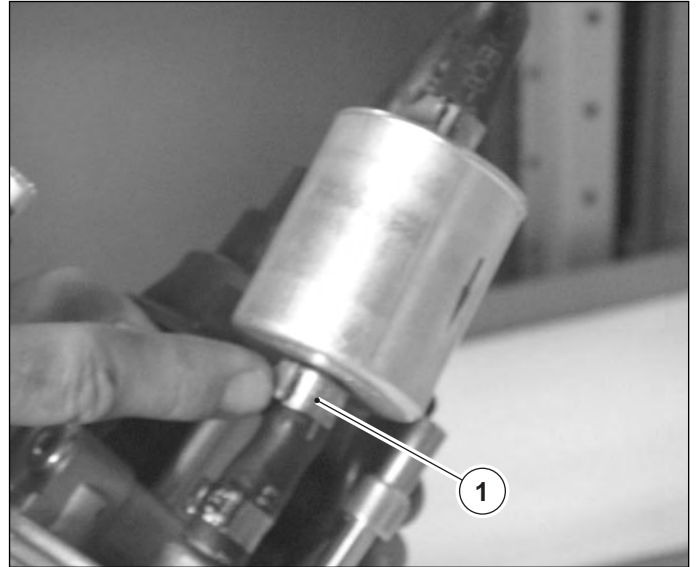

Remove the fuel filter (1).

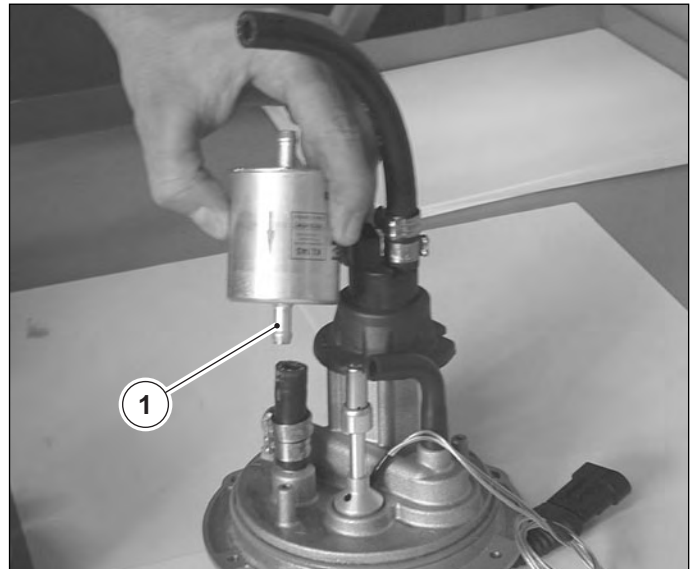

Extract the fuel pump (1) from its seat.

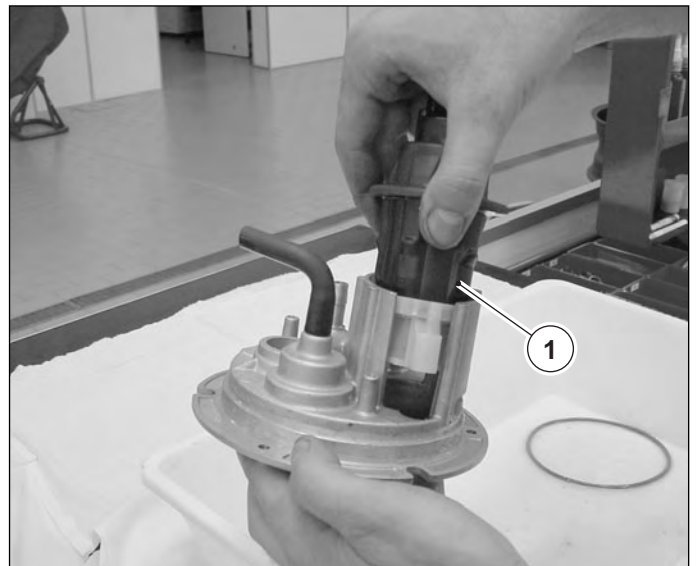



Maintenance

Disassemble the fuel filter **(1)** on the pump and blow in compressed air from inner to outer as shown in the figure.

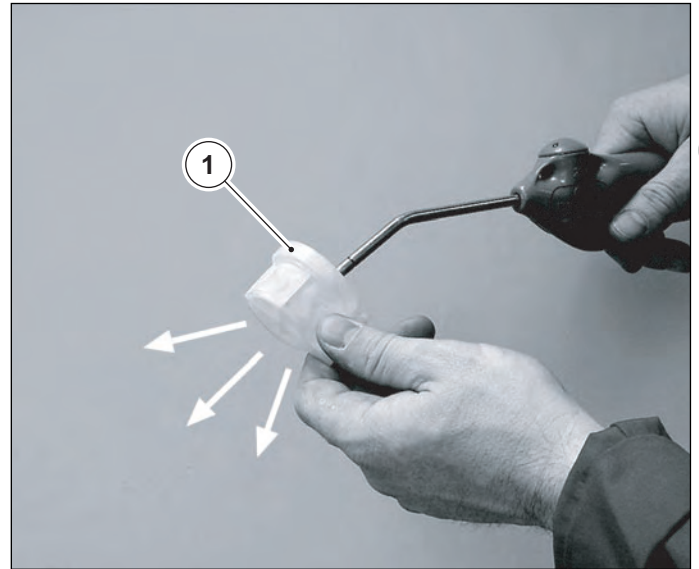

Clean the seat of the fuel pump and the fuel bowl. Remove any residue and ensure that there are no shavings that have originated from mechanical work.

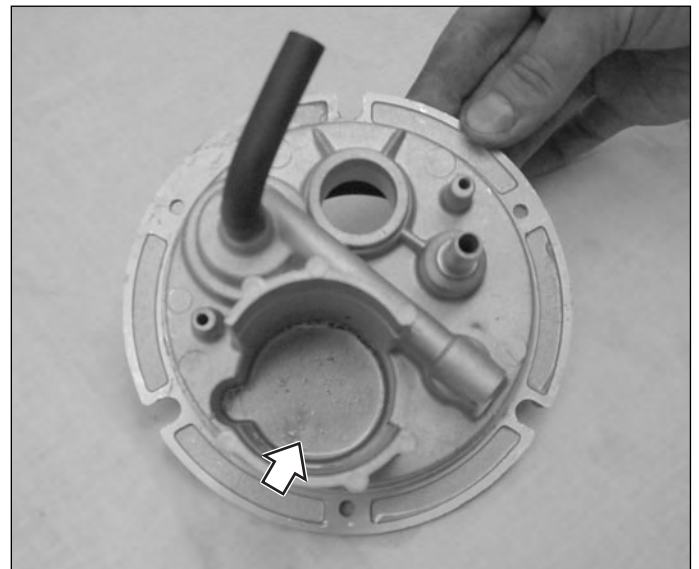

Degrease the threaded hole and the screw **(1)** with the appropriate solvent as shown in the figure. Clean and dry by blowing with compressed air.

Apply LOCTITE 542 thread-locking fluid.

Reassemble the screws and tighten to the specified torque.



Specified product LOCTITE 542



Torque pressure: 10 N·m

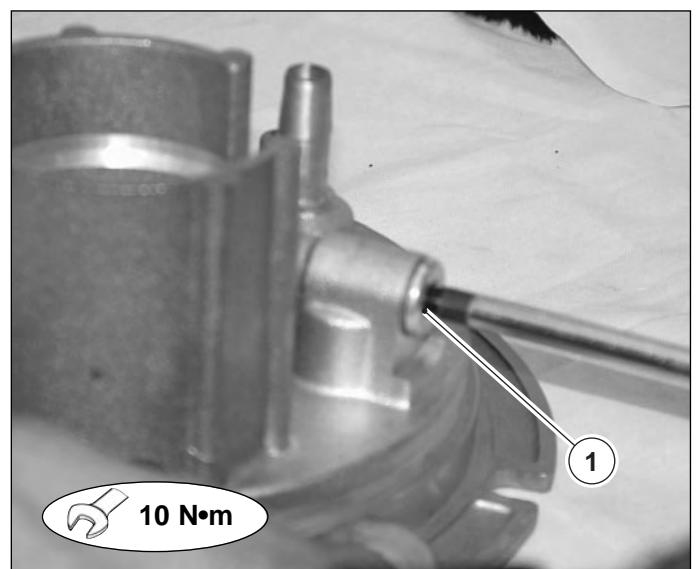



Maintenance

Using fine abrasive paper clean the first threading “crests” of the fuel probe seat as shown in the figure.

B This operation is necessary to not compromise the good condition of the gasket during the assembly phase of the probe.



Place the fuel filter on the pump in according to the timing shown in the figure.

 **Operate with care so that the net filter is not damaged.**



Assemble the CLIC R 96 135 fastener (1) –green colour – onto the tube as shown in the figure.

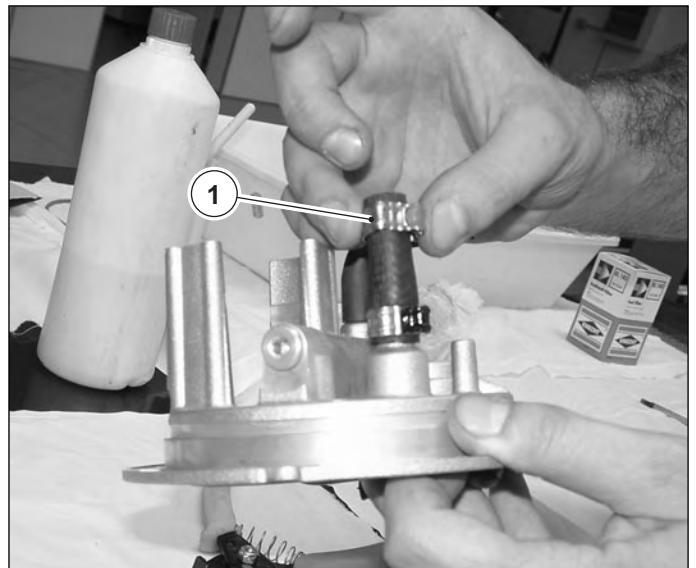



Maintenance

Insert a new fuel filter **(1)** within the pipe verifying its right placement (the arrow, marked on the exterior of the body must be oriented as shown in the figure).
If necessary, utilise alcohol to facilitate the assembly.
Tighten the CLIC R 96 135 fastener **(2)** – green colour – utilising the CLIC 205 pincers.

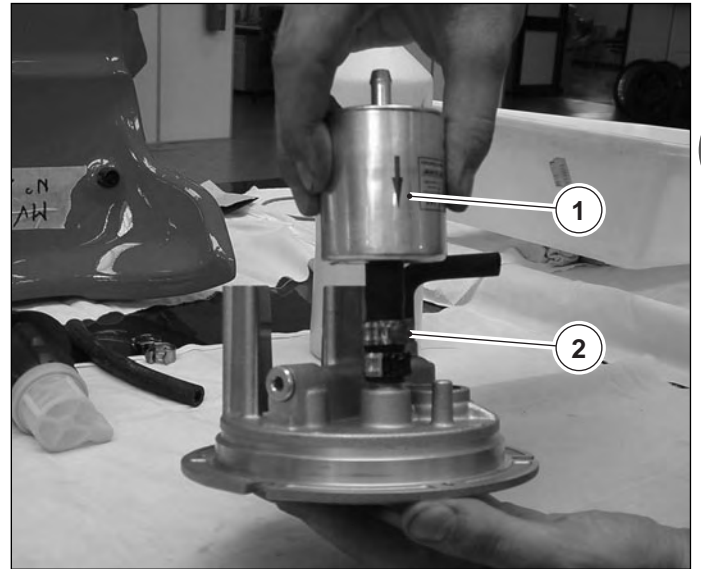

Insert the connection pipe of fuel filter / pump using alcohol in order to facilitate the assembly.

Assemble the CLIC R 96 135 fastener **(1)** – green colour – using the CLIC 205 pincers.

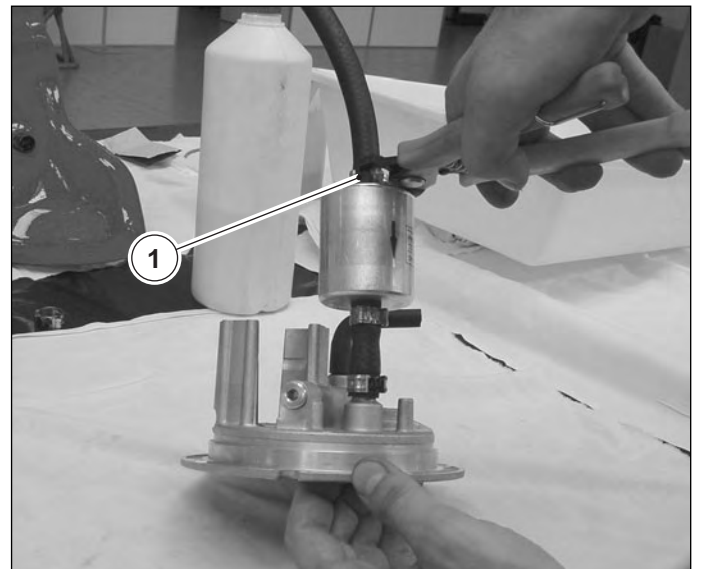

Insert the pump into its seat.

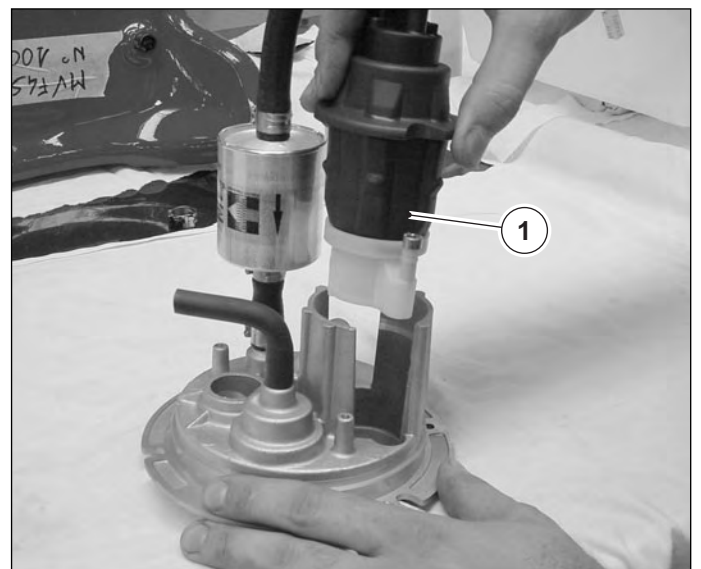



Maintenance

Insert the pipe on the fuel pump.
Facilitate the insertion using alcohol.

B Assemble the CLIC R 96 135 fastener (1) – green colour – using the CLIC 205 pincers.

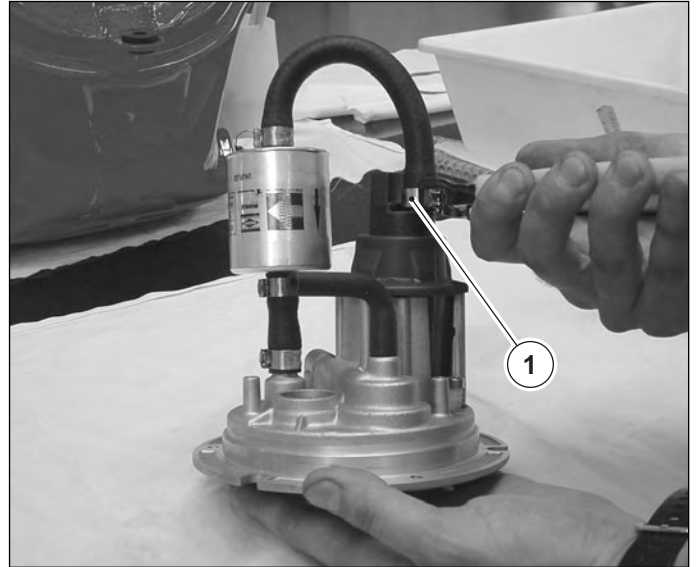

Assemble the fuel probe (1) on the die-cast flange.
When reassembling, substitute the gasket (2) with a new one and lubricate it with silicone grease.
Apply a light layer of silicone grease also on the threaded seat of the probe.



Tighten the probe so that the output position of the electrical wiring is in correspondence with the centre line of the writing "FRONT" between the two arrows.

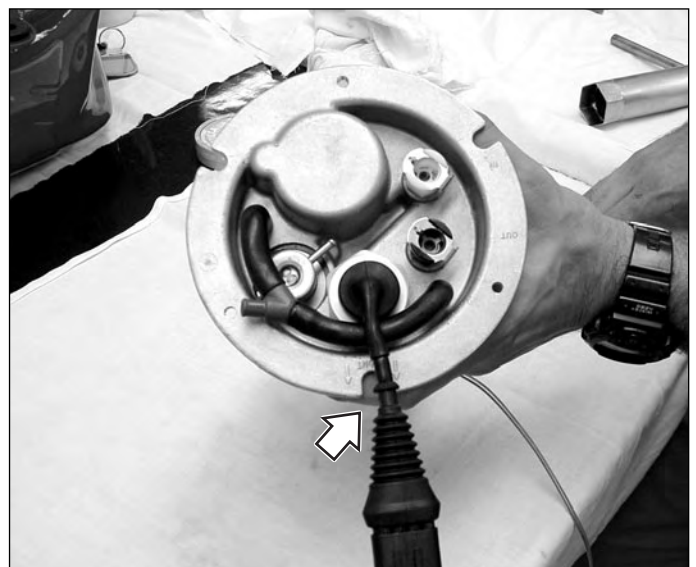



Maintenance

Reconnect the electrical connectors.

It is advisable to clean and degrease the contacts with the correct solvent.

Curl the electrical cable (1) into a circle at least twice to contain it in the space.

Place the tube (2) so that it is almost into contact with the fuel pump.

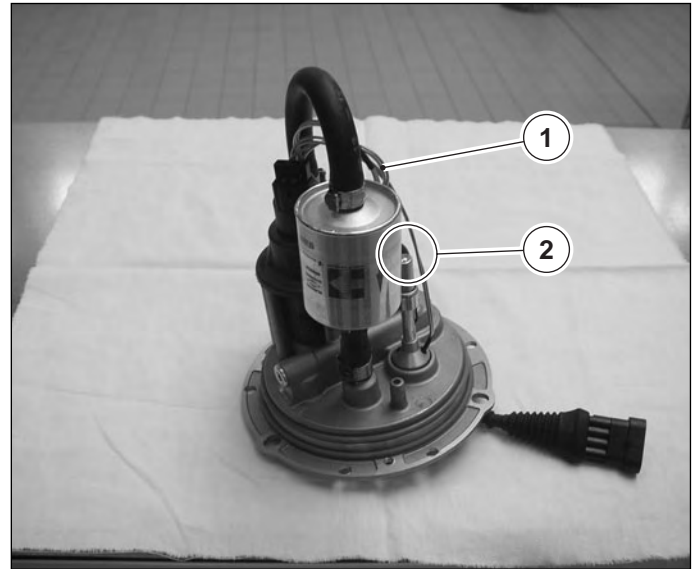

Complete the assembly of the flange group (1) inserting the sealing O-Rings (2) in their seat. Before assembling verify that components are undamaged and lubricate them applying silicone grease.

It is recommended to apply a layer of silicone grease on the seat of the die-cast flange.



The use of worn O-Rings can cause any fuel leakage from the tank motorcycle, and fire risk for the motorcycle as a consequence.

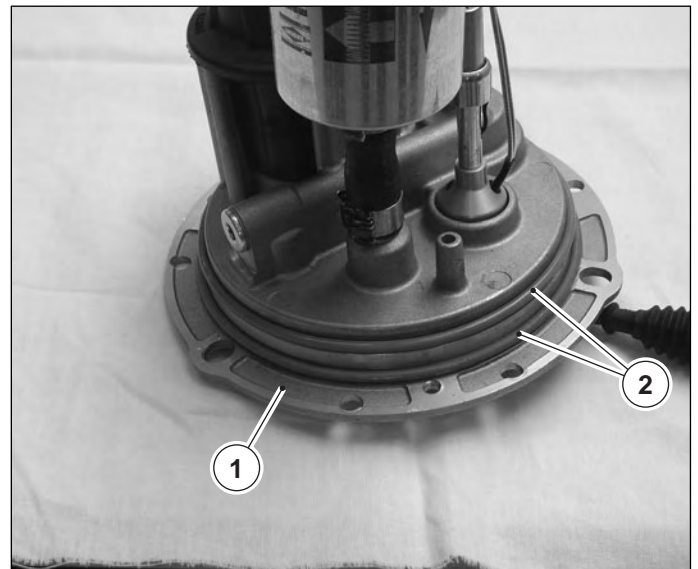

Carry out a check on the flange assembly.

Check the correct execution of all the operations carried out and described.





Maintenance

FUEL PUMP ASSEMBLY

B

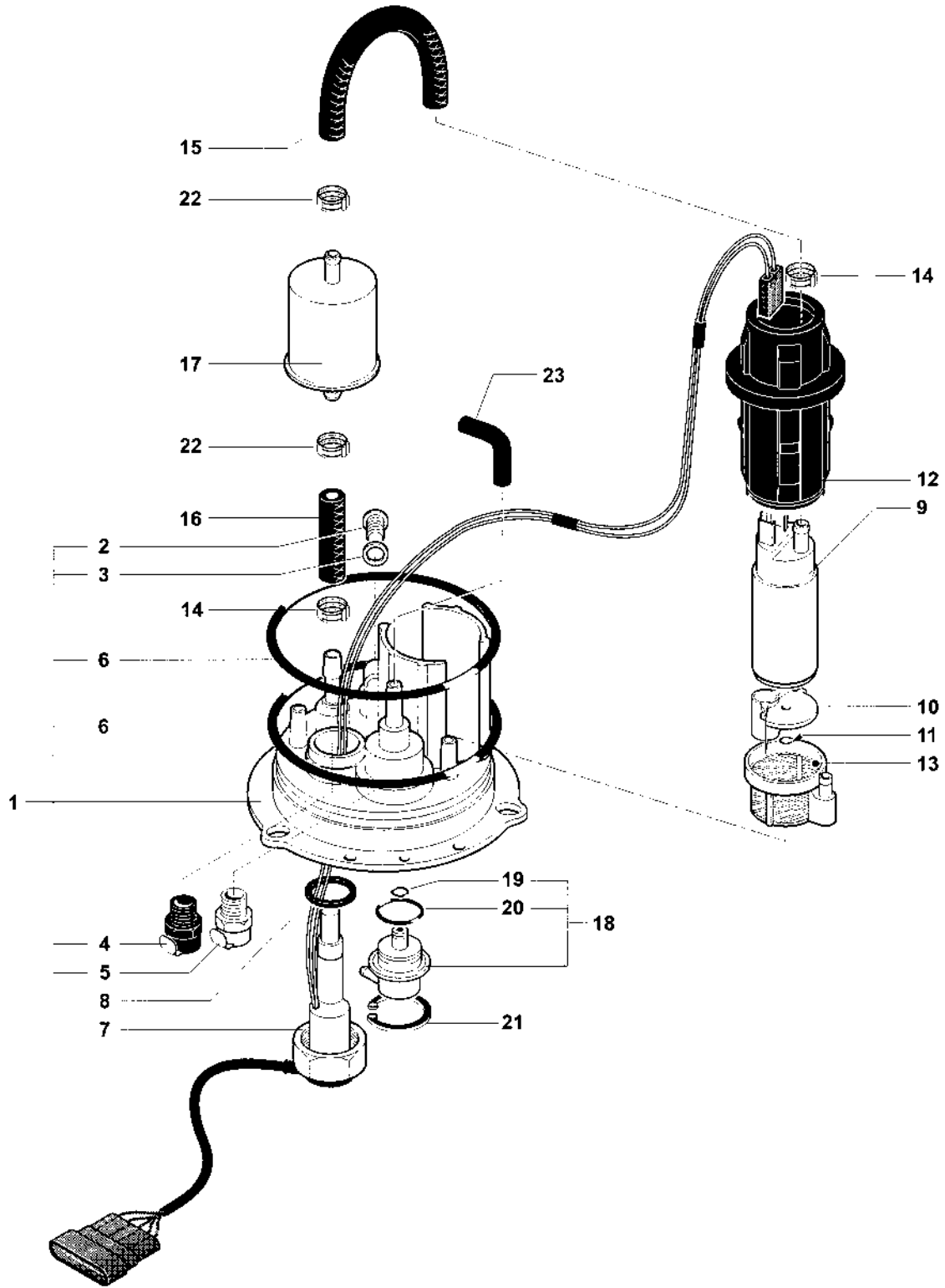



Maintenance

N.	Code	Q.ty	Note	BRUTALE ORO	BRUTALE S	► FRAME ►	► ENGINE ►
1	8A0094275	1		•	•		
2	800090927	1		•	•		
3	800021480	1		•	•		
4	80A090925	1		•	•		
5	800090925	1		•	•		
6	800090939	2		•	•		
7	8000A1400	1		•	•		
8	800090919	1		•	•		
9	800090920	1		•	•		
10	800093410	1		•	•		
11	800093411	1		•	•		
12	800090921	1		•	•		
13	800098305	1		•	•		
14	8M0092249	2		•	•		
15	8S0092249	2		•	•		
16	8E0087431	1		•	•		
17	8H0087431	1		•	•		
18	800088585	1		•	•		
19	800090929	1		•	•		
20	800093323	1		•	•		
21	800093324	1		•	•		
22	800090930	1		•	•		
23	800098304	1		•	•		

B



Fuel flange unit assembly

B Before starting the assembly of the flange to the fuel tank, check the condition of the two small overflow tubes connected to the lower part of the fuel filler cap. If these components are not in perfect condition, substitute them and position the band fasteners as shown in the figure.

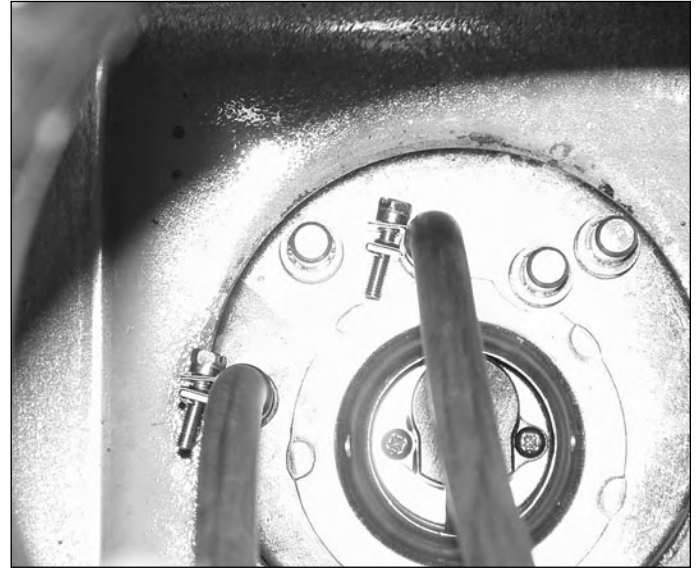

Position the flange unit (1) inside the fuel tank. Check that the two small overflow tubes (2) remain outside of the fuel tank.

Specific pliers: CLIC R 205
Part code 800095850

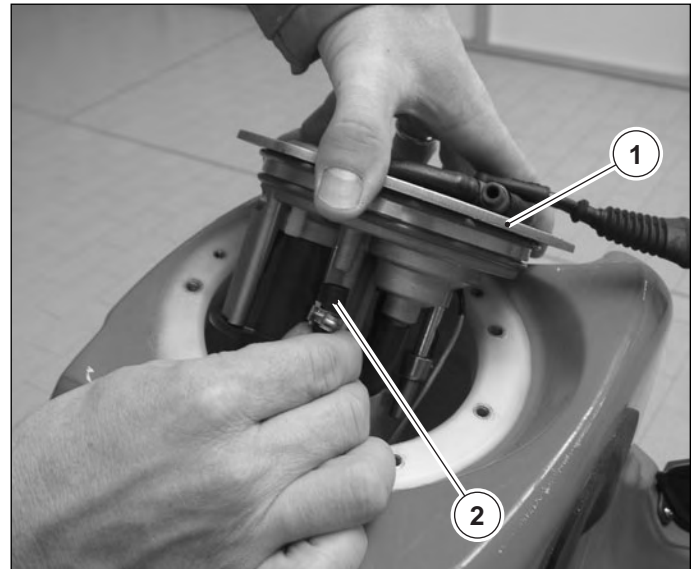

Insert two CLIC R 96 105 band fasteners (1) onto the small tubes. Insert the two small rubber tubes (2) onto the appropriate spigot on the die-cast flange. Tighten the band fasteners by using the CLIC 205 pin-cers.





Maintenance

Insert the flange unit inside the tank and tighten the nine fixing screws.



Torque wrench of fuel pump flange fixing screws: $6 \div 6,5 \text{ N}\cdot\text{m}$

Proceed with the assembly of the parts removed by following the removal operation in reverse order to that shown in chapter C "Bodywork":

- Fuel tank
- Tank side panel
- Ignition switch cover
- Rider seat
- Passenger seat

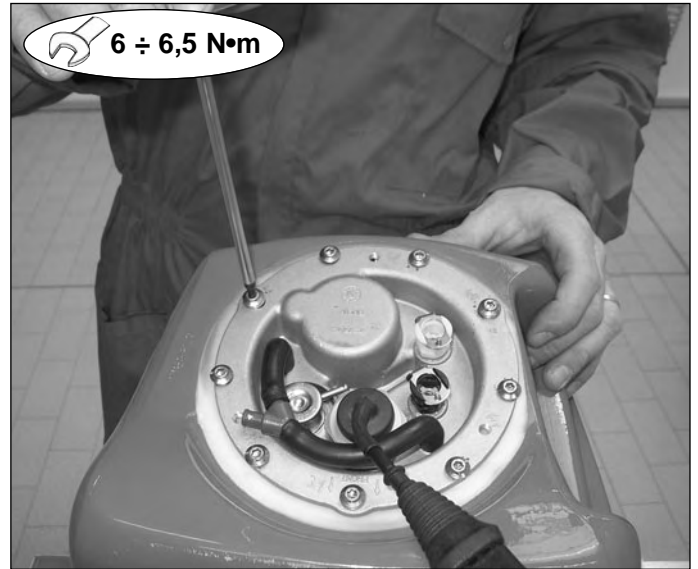

FUEL UNION TUBES

Check for leaks → First 1000 kilometres and then every 6000 kilometres

Carry out a visual check for eventual leakages from the fuel feed tubing and the unions (see figure). Substitute damaged parts if leaks or evaporation are found.

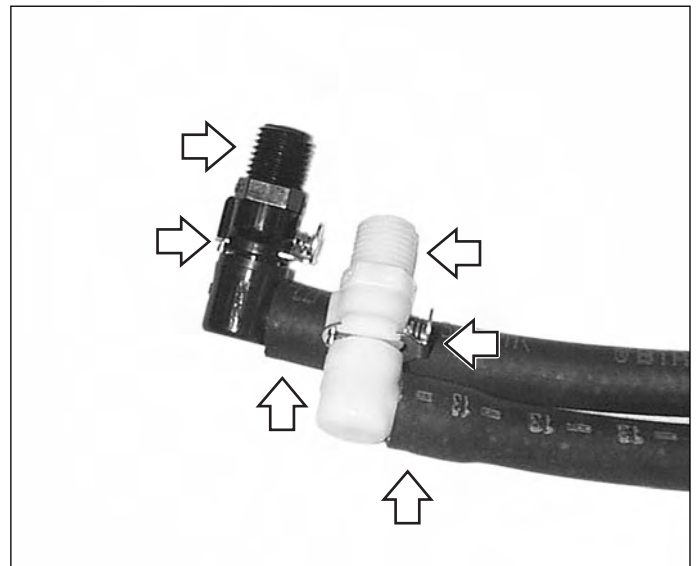

FUEL TUBES ASSEMBLY

Substitute → At least every three years

The procedure to follow in the case of substitution of the feed tubing is as follows:

Remove in this order:

- Passenger seat
- Rider seat
- Tank side panel
- Ignition switch cover
- Fuel tank

Insert the fuel tubes onto the unions of the throttle body.



UTILISE ONLY NEW PARTS.





Maintenance



The fuel tube with the white CPC union is assembled on the right side of the butterfly body.

The fuel tube with the black CPC union is assembled on the left side of the butterfly body.

Follow the indication shown in the figure.



Orientate the CPC unions as shown in the figure.

During the check, distend the tubes to eliminate flexions and deformation of the same.





Maintenance

Ensure that the tubes are correctly fitted onto the metal unions of the butterfly body and check that the rubber tubes do not cover the curved section of the metal union.

Position the “head” of the fastener as shown in the figure.



Fix the fuel tubes to the unions of the butterfly body by utilising the CLIC R 96 135 (green colour) fasteners.

Utilise the CLIC 205 pincers to secure them.



Specified pincers: CLIC R 205
Part code 800095850



Connect the pipes using the appropriate clamp that can be opened.

Ensure that the two tubes are of equal length and position the fasteners so that they are exactly aligned with the frame tube (see the figure).

Conclude the operation by reassembling the components in reverse order of disassembly.

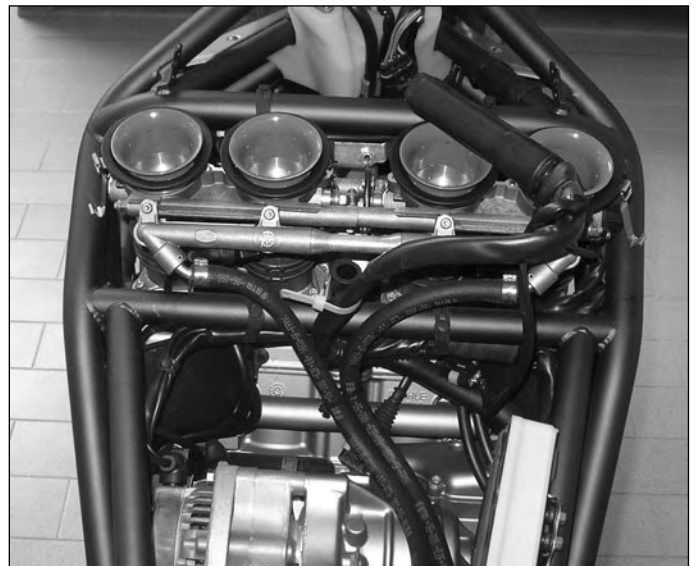



THROTTLE BODY ADJUSTMENT AND TUNING (Tickover check, CO synchronisation and check)

B Check and adjust → First 1000 kilometres and then every 6000 kilometres

The throttle body adjusting should be performed starting the engine of the motorcycle, therefore you should use a flue gas exhauster in order to not saturate the environment with burnt gas.

The following described operations are fundamental for the correct functioning and the maximum performance of the engine.

When carrying out operations on throttle bodies, it is advisable to remove certain parts of the bodywork such as:

- Passenger seat
- Rider seat
- Tank side panels
- Ignition switch cover
- Fuel tank

Attention: before adjusting the throttle body verify accurately:

- the absence of any cracks or damages on the pipes to check the depression;
- the absence of gas leakages from drain pipes joint;
- that the fuel pipe unions are not buckled and crushed.

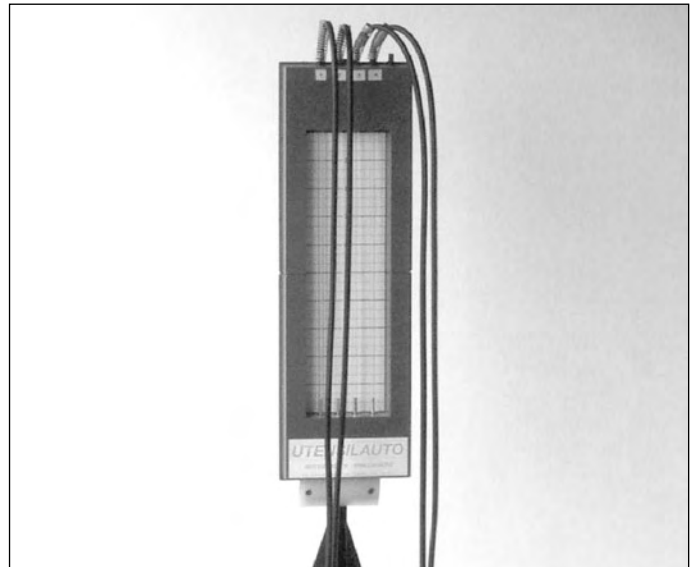

You should provide the motorcycle with tank placed on an auxiliary support. Therefore you should connect the hydraulic extensions of the fuel pipes and the electrical extension for feeding fuel pump.





Maintenance

Verify the parameters of the injection-ignition system by the MDST diagnosis software.

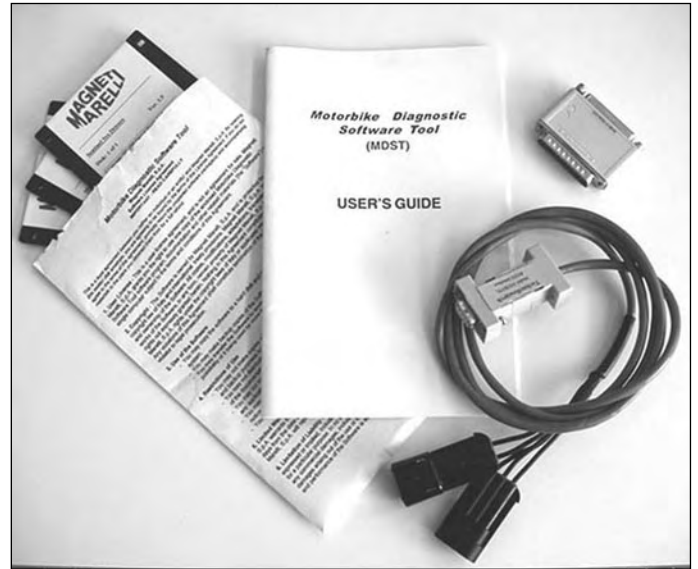

Connect the tool cable of the MDST diagnosis with the "Diagnostics" tap on the right side of the motorcycle near the expansion tank of the coolant.

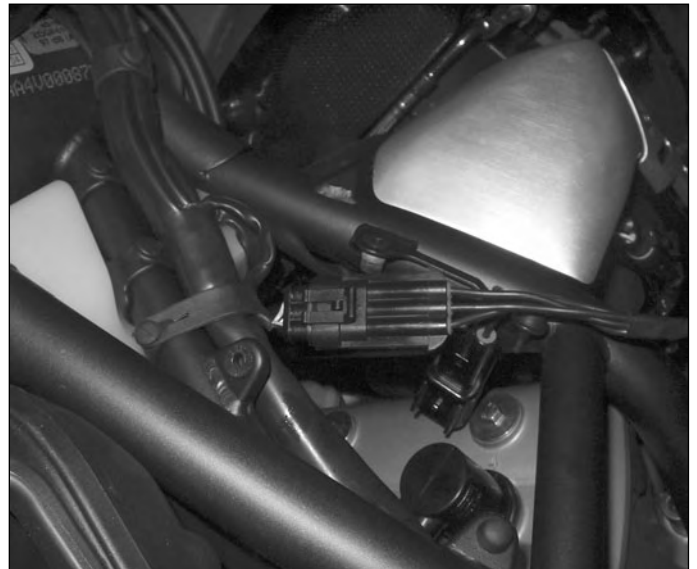

Start the MDST diagnosis software and go to the "Display instrument panel" screen.
Set the ignition switch to ON.
Select the "Connect" option from the toolbar. Now the software displays the main operating parameters of the injection-ignition system: verify that the temperature and pressure sensors have coherent readings.

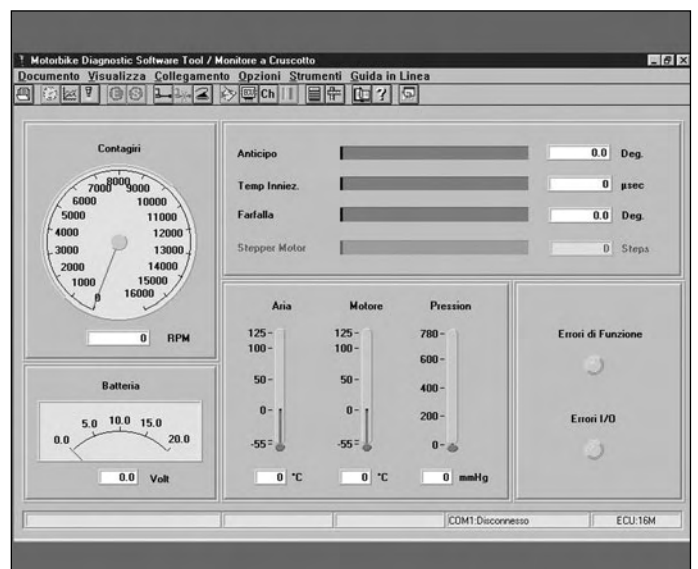



Maintenance

Check the throttle angle when the throttle is completely closed.

The nominal throttle opening angle is 1.7° .

Huntings between 1.5° and 1.7° are allowed only if the engine is started.

Huntings between 1.7° and 1.9° and between 1.3° and 1.5° are not allowed.

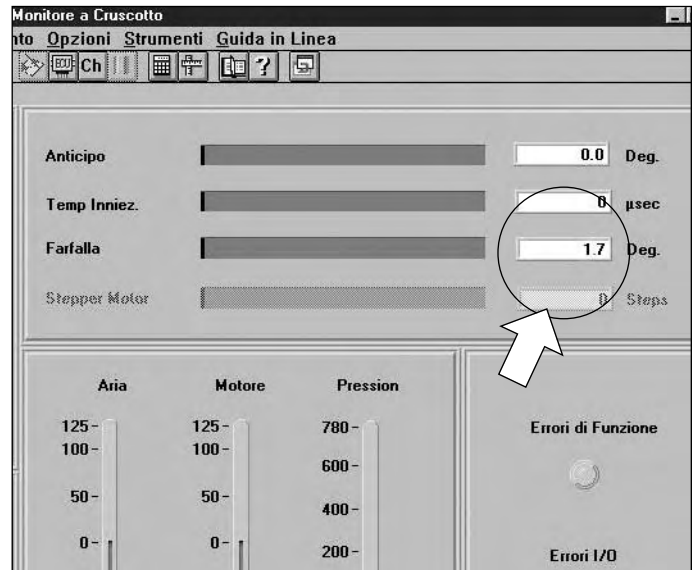

If necessary adjust the throttle opening using only the appropriate screw on the throttle opening pulley. It is recommended not modify the throttle potentiometer position because the throttle has been set during the production to the optimal value.



Remove the sealing caps of the small tubes to check the vacuum pressure.

The number of the cylinder to which the caps are connected is written on the caps.

The small tubes for checking the vacuum pressure are situated on the left and right side of the motorcycle.





Maintenance

Connect the depression pipes with the vacuum meter complying with the match between the pipe and the cylinder which is connected to.

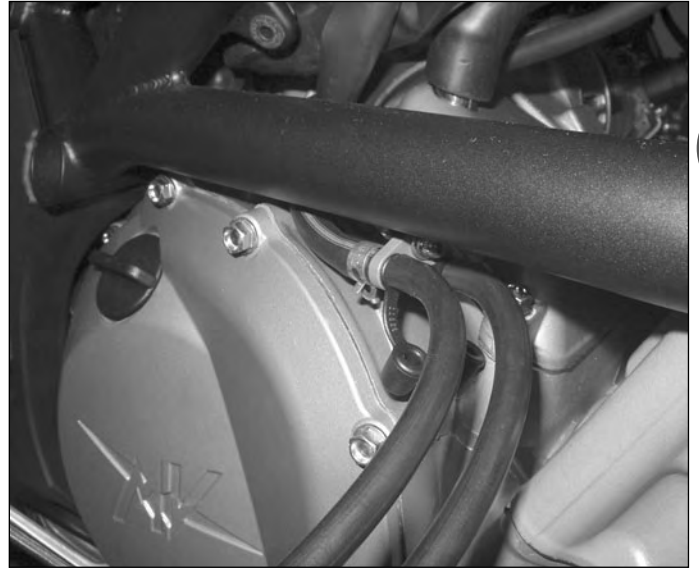

In order to perform the following operations, you should provide with the specific tool kit for setting CO.



Specific tool:
Part code 8000A4686

Remove the sealing caps of the CO drives placed on the exhausts.

Insert and screw the 2 probes registering CO inside the specific tool kit (code 8000A4686).

Assemble the 2 pipes with their Y union, also supplied with tool kit, code 8000A4686, on the probes registering CO.

Connect the Y union with a rubber pipe to the exhaust gas analyser.

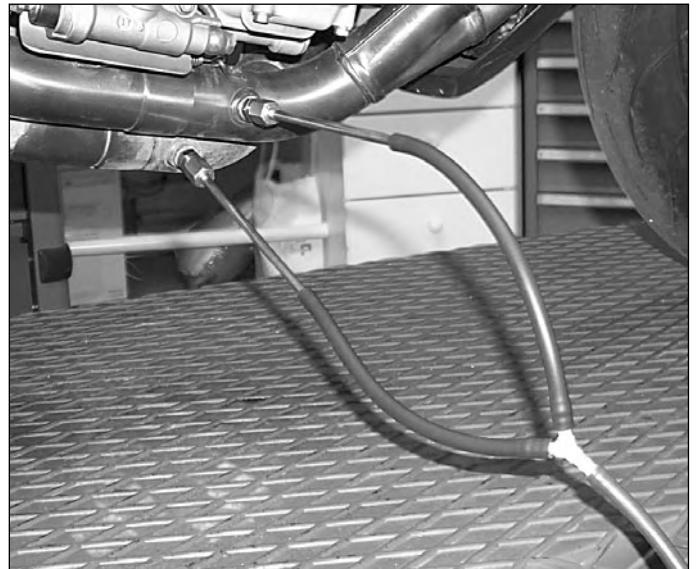

Verify that the ignition switch is set to OFF.

Disassemble the injection-ignition gearcase placed on the air filter compartment unscrewing the four fixing nuts.

Reset the earth bonding on the gearcase by using a nut and a M6 screw (for the correct performance of the adjusting operations, it is important the gearcase is earthed).



Remove the seal plate and then the gearcase sealing cap.

B



Operate the by-pass screws in order to return to a known condition.
Close completely the screws and then open them for 1 turn again.



Start the engine and warm it up. During this phase you should not accelerate because the high depression created in the induction lines could pipe the mercury from vacuumeter.

The engine rotation can be supported by using the starter.

The attainment of the correct thermal speed is given by the intervention of the cooling fan.





Maintenance

Balance the depressions in the cylinders: the thermometers should get to the same height (reference level = 2).

Se all engine parameters are correctly set, the position of the adjusting screws should be between 1 and 1.5 rpms from the fully closed position.

Keeping the depressions aligned, adjust the engine speed (with fan connected and light on) so it is between 1100 and 1200 rpms.



Check the CO value using the exhaust gas analyser. This value must be between 3% and 4%.

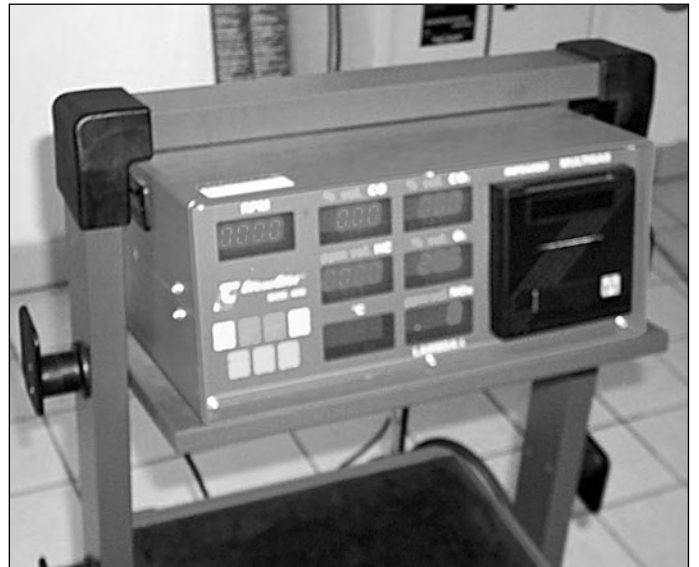

If the CO value does not fall into the established values, operate the trimmer inside the gearcase until the values fall into the tolerance range.

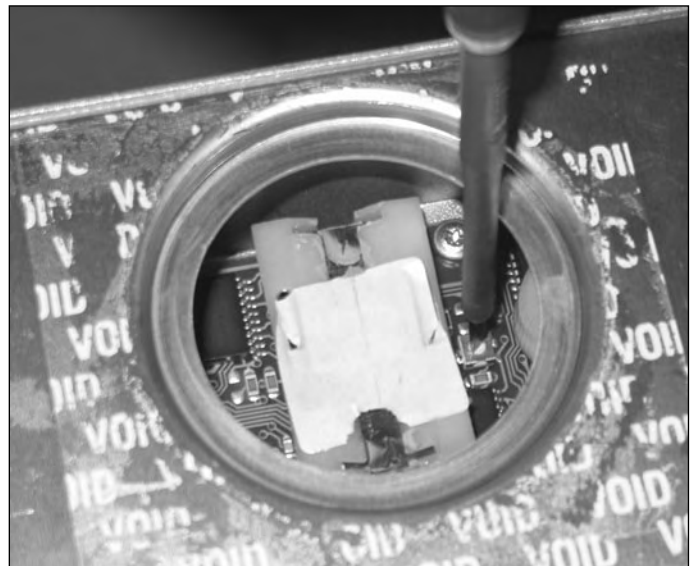



Maintenance

The attainment of the correct CO value could involve a variation of the engine speed at minimum.
In this case you should operate the by-pass screws again to return the speed to the desired value and then repeat the trimmer adjustment.

B



After having finished the adjustment operations, perform in the order as follows:

- assemble the rubber plug on the gearcase lower side;
- apply a new seal plate;
- assemble the gearcase on the air filter compartment restoring the earth bonding;
- disassemble the exhaust gas probes and tighten the fixing screws;
- restore the sealing caps of drives for checking depression;
- reassemble tank, tank side panels, ignition switch cover, rider seat and passenger seat.



After reassembling all parts, carry out a final check to ensure that everything has been correctly replaced.





AIR FILTER

Check/substitute

Every 6000 kilo-
metres

Certain parts must be removed in sequence before acceding to the air filter. See chapter C "Bodywork":

- Passenger seat
- Rider seat
- Left tank side panel
- Right tank side panel
- Ignition switch cover
- Fuel tank
- Air filter compartment

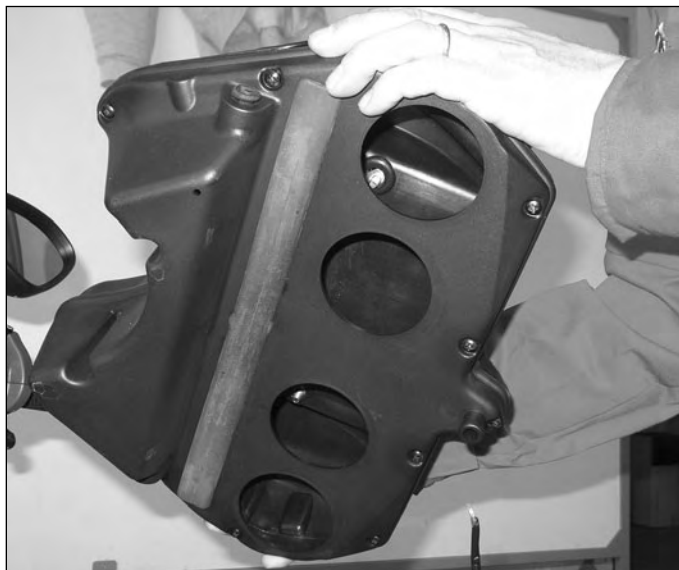

Remove the sealing rubber gasket (1).



Work on the three "tongues" of the air filter and extract it from the air filter compartment.





Maintenance

Check the condition of the air filter. If it is necessary to substitute it, proceed as follows:

Prepare a new air filter.

Check that the inside of the air filter compartment is clean and free from foreign bodies.

B

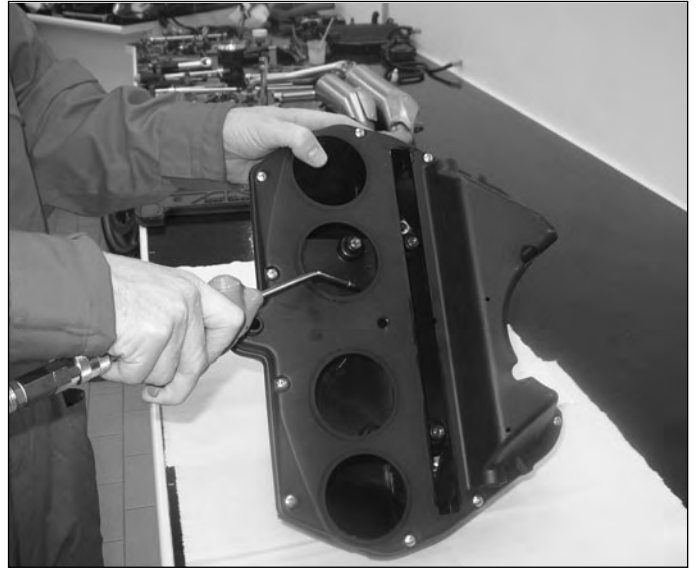

Insert the air filter complying with the correct assembly direction shown in the figure.

Press in the three fixing tongues until a click is heard.

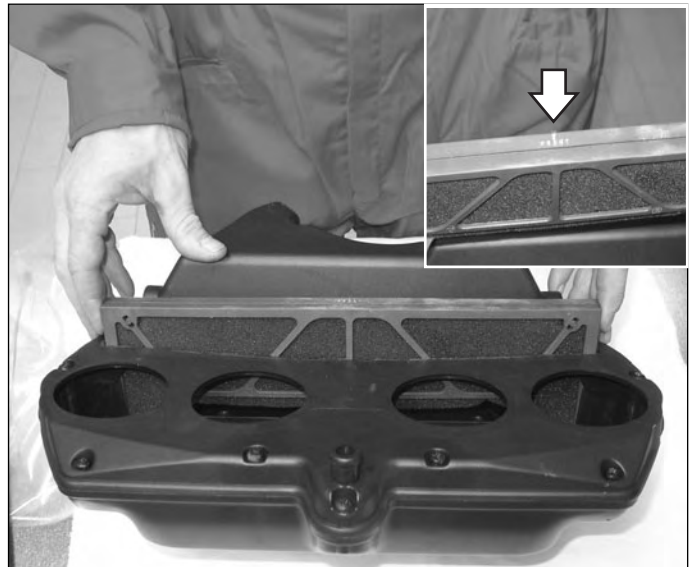

Complete the assembly of the filter into the air filter compartment sealing the operation opening by the rubber gasket as shown in the figure.





Maintenance

Before proceeding with the assembly of the air filter compartment onto the motorcycle, apply silicone grease to the gaskets of the air intake bell chambers.

Proceed with the assembly of the parts listed below and according to the procedure described in chapter C "Bodywork":

- Air filter compartment
- Fuel tank
- Right tank side panel
- Left tank side panel
- Ignition switch cover
- Rider seat
- Passenger seat



B



BRAKES AND CLUTCH

B Check the levels of fluid in the systems → At pre-delivery, at first 1000 kilometres and then every 6000 kilometres

Check for leakages → At pre-delivery, at first 1000 kilometres and then every 6000 kilometres

Substitute fluid → Every 24000 kilometres or at least every two years

Commands check → At pre-delivery, at the first 1000 kilometres and then every 6000 kilometres



Check brake and clutch fluid levels

The procedure that is described as follows must be carried out for the fluid chambers of both the front and rear brakes and also the clutch chamber.

Place the motorcycle in a vertical position with the handlebars straight.

Check the fluid levels in the brake and clutch fluid chambers observing the lines for the level marked on the chambers.

If the level is lower than the lower level line, add brake fluid complying with the specification by the manufacturer in according to the following procedure:

- Remove the 2 screws from the fluid tank cover;
- Remove the three elements of the cover.



Add brake fluid until the correct level is reached in the chamber.



Recommended brake fluid: AGIP DOT 4 or equivalent.



Do not use brake fluid that comes from old containers, has already been used or does not come from a sealed container. Do not use brake fluid that is left over from previous maintenance or stored for long periods. Utilise only the recommended brake fluids.





Maintenance

In order to access the back brake fluid tank you should remove the fuel tank as described in the Chapter C “Super structures”.



Likewise proceed to the front brake fluid tank.



Before completing the operation, clean and wash accurately the 3 components of the chamber cover using alcohol and blow to dry them.

Clean the edge of the fluid chamber with a clean cloth. Close the fluid chamber with the two relative screws.



Imperfect cleaning of these parts could cause the discharge of small quantities of brake fluid during riding. Brake fluid has strong corrosive properties.





Maintenance

Check eventual leaks and blow-bys of brake and clutch fluid on the unions and tubing.

If any breakages are seen, substitute the damaged parts as described in chapter H “Brakes”.



Brake fluid leakages are dangerous and immediately discolour painted surfaces. Before riding, check the tubes and joints of the brakes for damage and signs of leaks.



Substitution and bleeding of the brake/clutch fluid

The substitution of the brake/clutch fluid and the successive bleeding of the circuit are operations that require particular caution and precision. To carry out these operations, it is therefore necessary to follow the procedure described in chapter H “Brakes” of this manual.

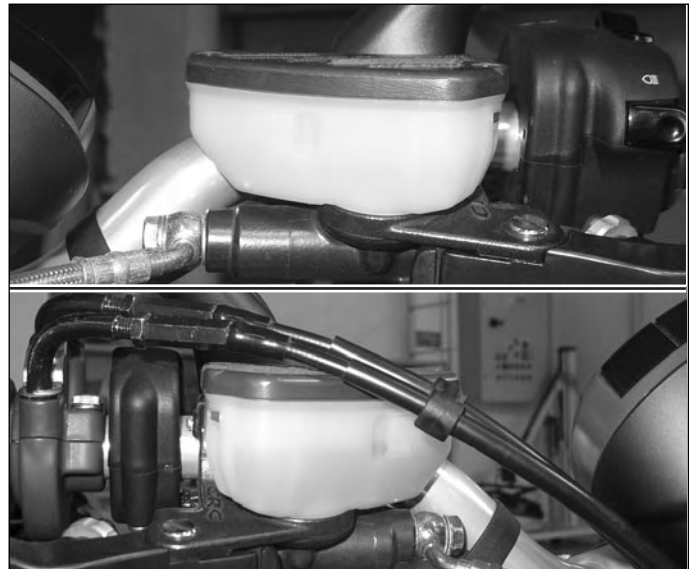

BRAKE/CLUTCH/GEARCHANGE COMMANDS CHECK

It is possible to effectuate the adjustment of the position of the levers of the front brake, the clutch and also the gearchange lever. Such adjustments have been created to optimise the grip and the movement of the commands with regards to the needs of the motorcyclist.

The commands of the motorcycle are initially calibrated to a standard position, but can be altered as follows.

Front brake and clutch lever adjustment



Never carry out adjustments whilst riding the motorcycle.

Pull the lever to neutralise the push of the spring and at the same time, adjust the position by rotating the ring in a clockwise or anti-clockwise direction.

In a clockwise direction: The lever goes further away from the handgrip.

In an anti-clockwise direction: The lever comes closer to the handgrip.



Whenever the command levers do not function correctly or have excessive play, consult chapter H “Brakes” for the overhaul of the same.

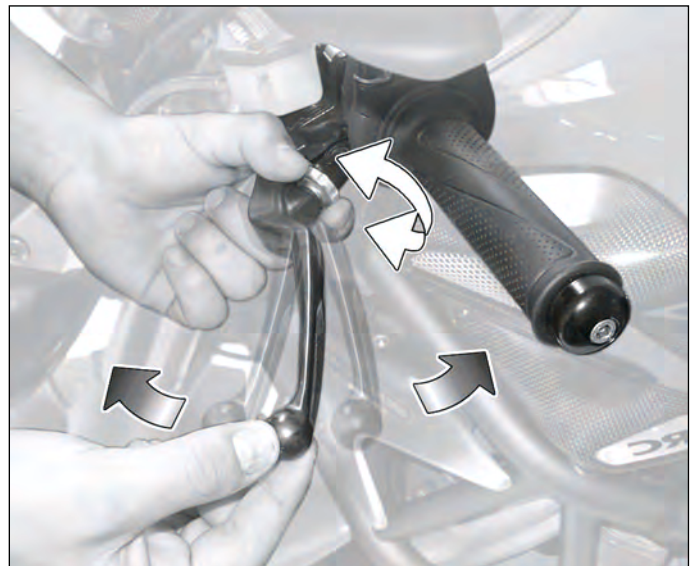

Gearchange/rear brake lever adjustment

To carry out the adjustment of the rear brake lever and the gearchange lever, slacken the screw (1) utilising a 5 mm Allen key. Adjust the position according to the requirements of the rider utilising the same key and on the hexagonal hole (2).

Tighten the screw (1) to the torque prescribed.



Brake lever adjustment torque pressure: 6 N·m

Operate on both the gearchange and rear brake levers in the same way.

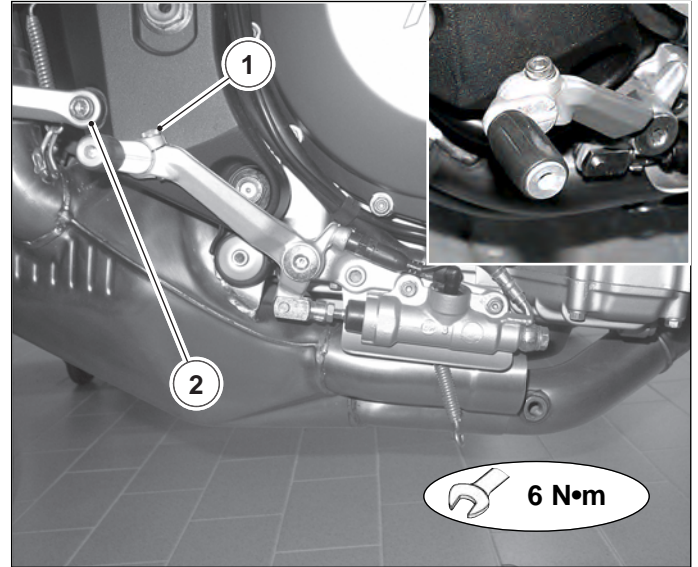

(Only for the Brutale ORO model)

Footrest adjustment

On the BRUTALE ORO model, the footrests are adjustable. Operate as follows for the adjustment from the original position:

- Slacken (without removing) the eccentric adjustment screw (situated at the rear of the footrest support) using a 12 mm hexagonal spanner.
- Loosen (without remove) the two fixing screws of the frame board support using a 6 mm setscrew wrench.

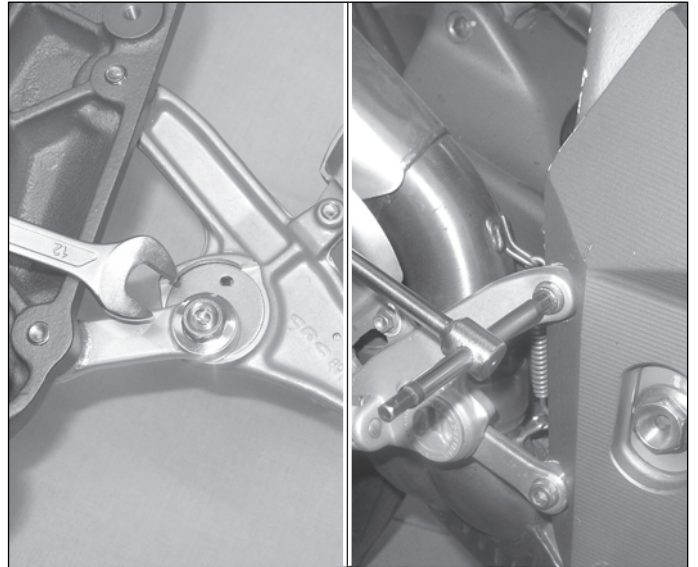

- Lay (without tightening) the eccentric adjustment rear screw. Effectuate the adjustment by utilising the correct size screwdriver.



Adjust both footrests to the same adjustment value.

- Tighten the two footrest fixing screws utilising a torque wrench.



Torque pressure: 24 ÷ 28 N·m

- Tighten the rear eccentric adjustment screw.

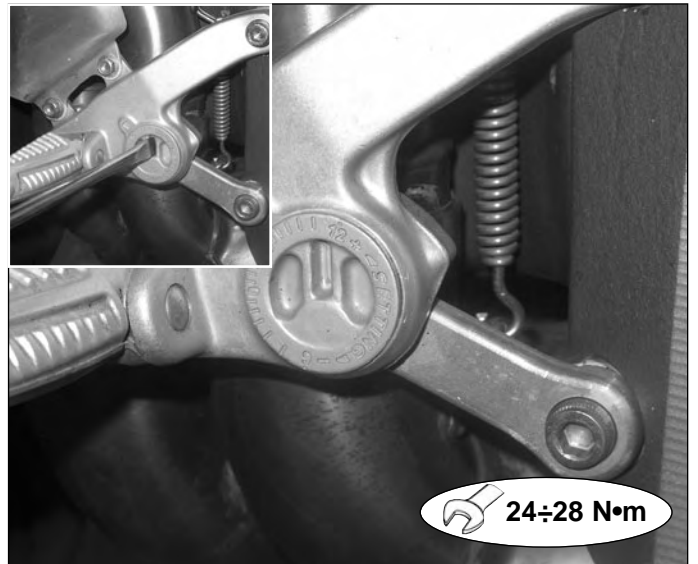



Maintenance

BRAKE PADS

Check/substitute →

At the first 1000 kilometres and then every 6000 kilometres

Check the condition and thickness of the brake pads on the pincers.

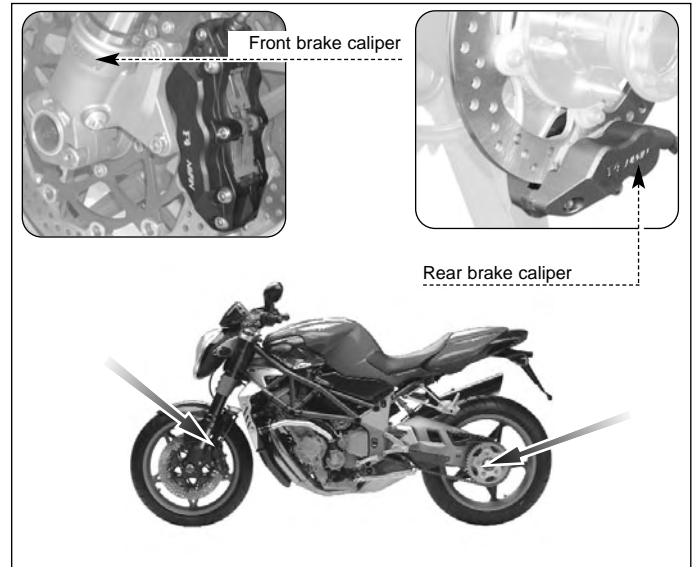

The brake pads have small channels that assist in checking the wear. If these channels are not visible or are about to disappear, it is therefore necessary to substitute the brake pads as described in chapter H "Brakes".

Wear limit: 1 mm.



If the brake pads are substituted, it is necessary to effectuate a proper running-in period before reaching an optimal braking efficiency.

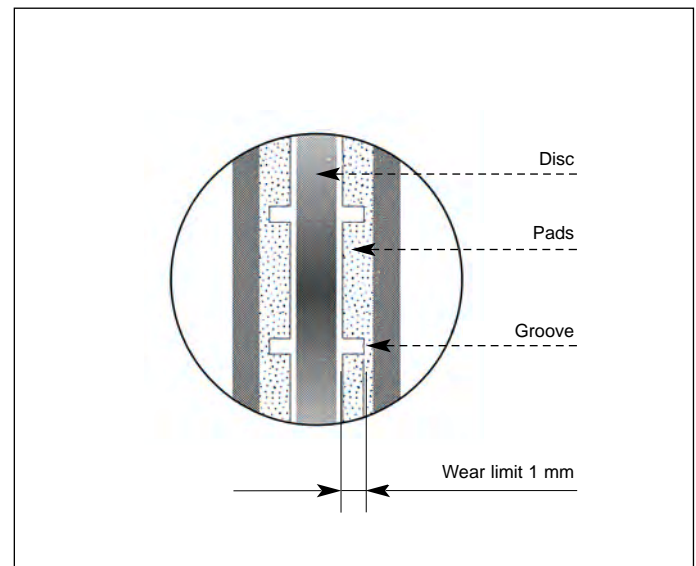

ACCELERATOR CONTROL

Accelerator play check →

At the pre-delivery check, at the first 1000 kilometres and then every 6000 kilometres

The accelerator control should not be too tight or too slack (excessive play) in its movement. It must also be free of play and looseness when turning it.

For optimum adjustment it is necessary to work on the two upper nut adjusters (situated on the accelerator handgrip).



The lack of play on the closure of the accelerator (1) can stop the complete closing of the throttle valve and the accelerator could remain in the open position, thereby leaving the engine with a fast tickover. It is the same for the opening transmission (2).

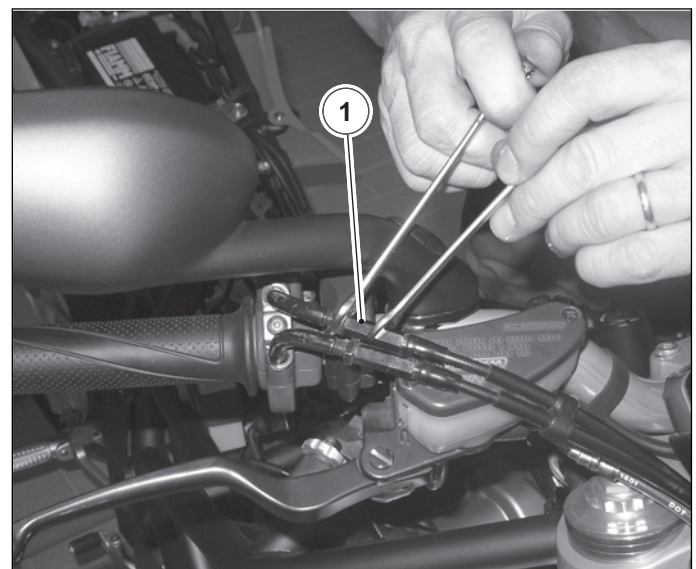

After making adjustments, check that the throttle valves open slightly by activating the choke lever (1), as indicated in the following figure.

B

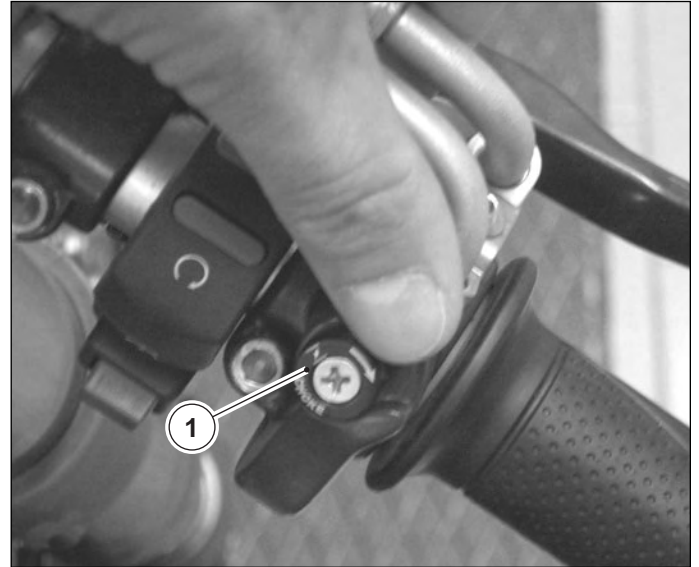

If interventions have been carried out on the throttle bodies, the transmission of the accelerator control must be analysed not only at the accelerator handgrip but also near to the throttle bodies.

It is therefore necessary to consult chapter D “Air intake injection system”.



As a final control and after having reassembled all the components, switch on the engine and check that, with the choke lever activated, the tickover of the engine does not exceed **2500 r.p.m.**





LOCKS

Check → At the pre-delivery, at the first 1000 kilometres and then every 6000 kilometres

Ignition/steering block switch

This switch has four operating positions.



Do not attach key rings or other objects to the ignition key that could obstruct the rotation of the steering.

The ignition switch activates and deactivates the electrical system and the steering lock. The four control positions are as follows.

“OFF” position

All electrical circuits are deactivated. The key can be pulled out.

“ON” position

All electrical circuits are activated, the instruments and warning lights carry out self-diagnosis and the engine can be switched on. The key cannot be pulled out.



Do not attempt to change the functions of the ignition switch whilst the motorcycle is being ridden. It could cause the rider to lose control of the machine.

“LOCK” position

Turn the handlebar left or right. Press the key down and rotate it to the “LOCK” position. All electrical circuits are deactivated and the steering is blocked. The key can be pulled out.

“P” position

Rotate the key from the “LOCK” position to the “P” position. All electrical circuits are deactivated except for the sidelights. The steering is blocked. The key can be pulled out.

If the ignition switch unit is damaged (it does not allow the positioning of any one of the four positions), it must be substituted with a new ignition switch unit following the sequence of the disassembly as described in chapter G “FRAME”.

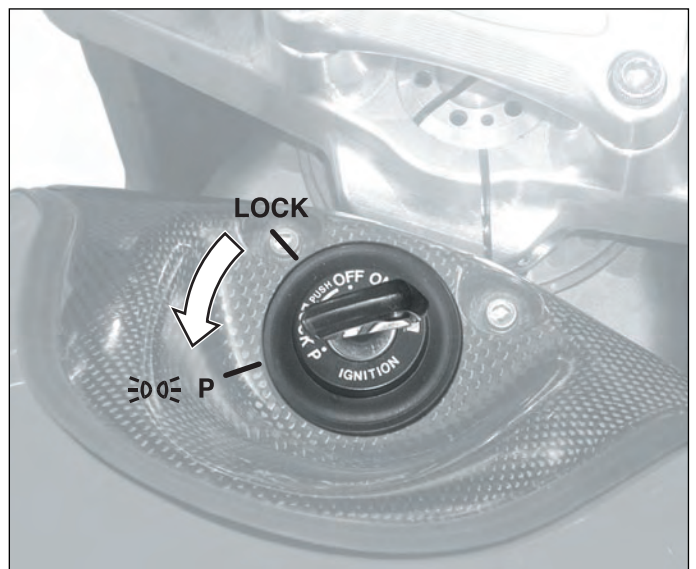
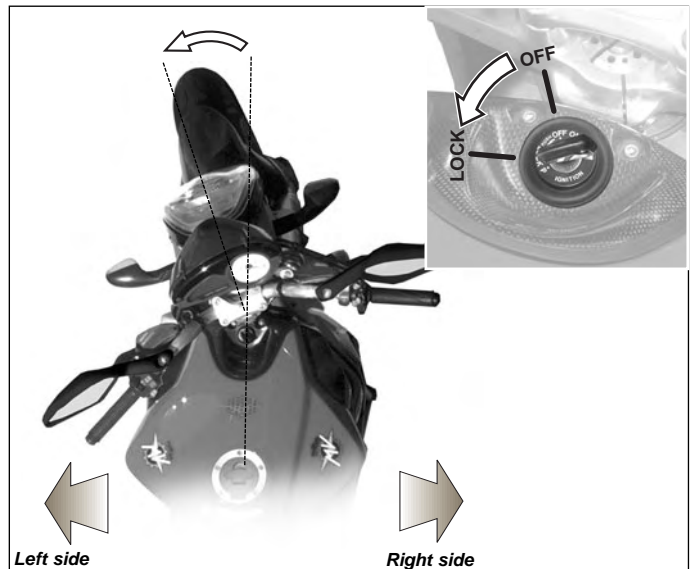
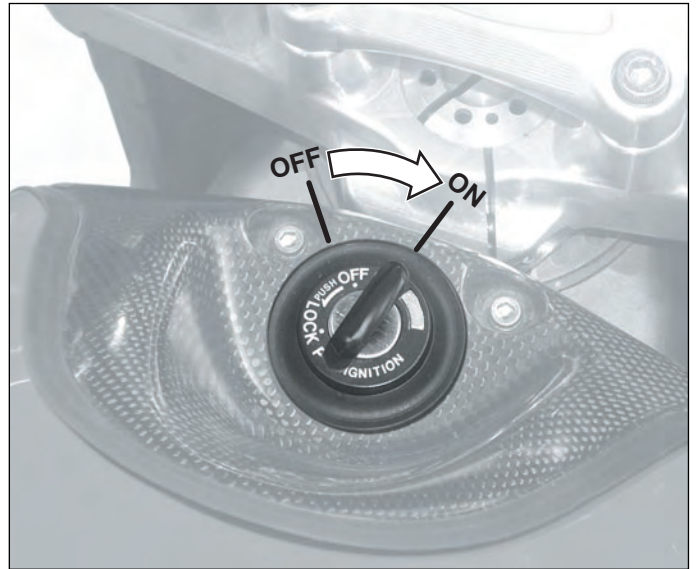

B

Fuel cap lock

Lift up the anti-dust cover.

Insert the key, rotating it in a clockwise direction and lift up the cap.

After refuelling, press the cap down and rotating the key contemporaneously to facilitate the closure. Press and hold the cap, let the key go free, bring it into a longitudinal position and pull it out.

If the fuel filler cap does not function (the cap does not close, the lock blocks, etc.) substitute it with a new one as described in chapter C "Bodywork".

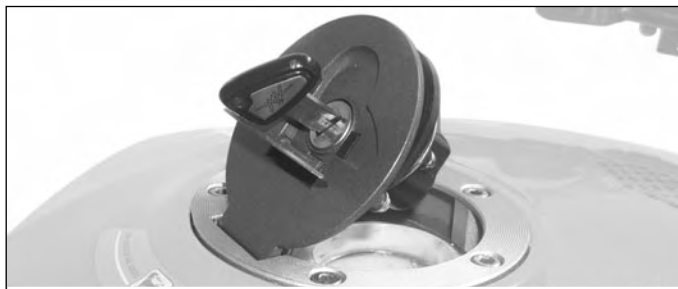

Personal compartment lock

Insert the key in the lock.

Turn the key clockwise and at the same time press the passenger seat slightly.

Lift and take out the passenger seat.



For reassembling the part refer to the following indications:

- Turn the key in the lock
- Press the passenger seat
- Release the key
- Press again the passenger seat, verifying it is well fastened to the structure.

 **After having removed or lifted the passenger seat, and in any case before using the motorcycle, ensure that the components are correctly placed and well fastened to the supporting structure of the motorcycle.**





B

STEERING

Check and adjust → At the first 1000 kilometres and then every 12000 kilometres

Check the steering components regularly according to the above-mentioned intervals.
If it is necessary to carry out adjustments, operate as described in chapter F "Suspension and wheels".

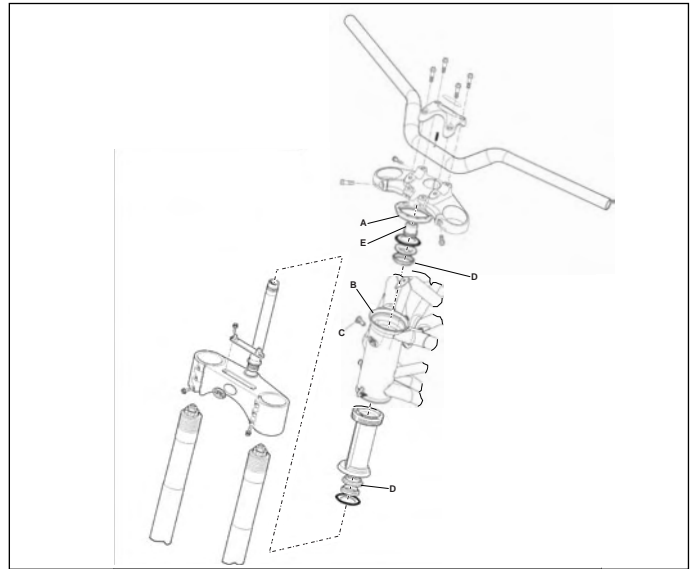

TRANSMISSION CHAIN

Check → At the pre-delivery, at the first 1000 kilometres and then every 6000 kilometres

Substitute → Every 6000 kilometres (Brutale ORO)
Every 12000 kilometres (Brutale S)

Place the motorcycle on the rear stand.
The chain tension check should be effectuated with the motorcycle having a static set-up quota equal to the following standard values (see chapter F "Suspension and wheels"):

BRUTALE ORO - S (MY 03): 190 mm
BRUTALE S (MY 04): 200 mm

The clearance "h" between the axis of symmetry of the chain and the chain cover should be equal to the following values as shown in the figure.

BRUTALE ORO - S (MY 03): h = 6 mm
BRUTALE S (MY 04): h = 11 mm

Manually rotate the rear wheel and effectuate this check on more than one point of the chain. The play must be constant whilst the wheel turns. If the chain is slack in only certain places means that the some links are stretched or seized.

Visually check the transmission chain for the following defects:

- Slack pins
- Damaged rollers
- Dry and rusty links
- Bent or seized links
- Excessive use
- Incorrect chain adjustment
- Damaged O-rings

The chain must be substituted if any one of these defects is found.

When substituting the transmission chain, substitute also the crown and pinion wheel.

For the substitution of the chain, pinion, crown wheel and to check the wear of the chain guide, follow the sequence described in chapter F "Suspension and wheels".

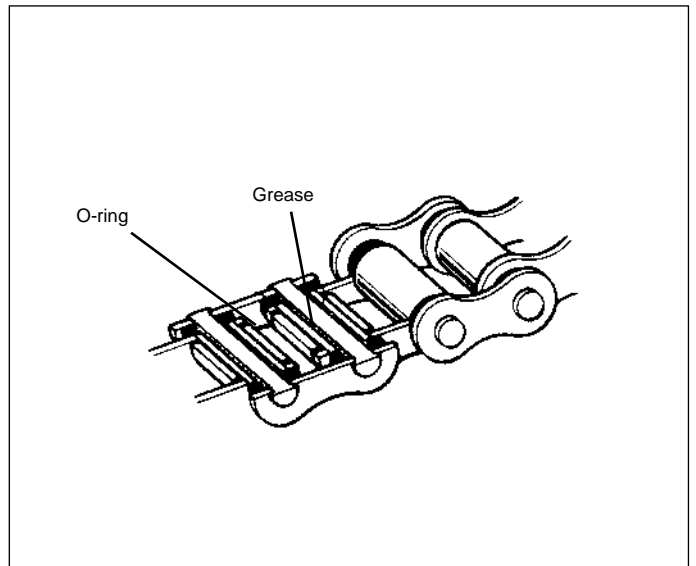
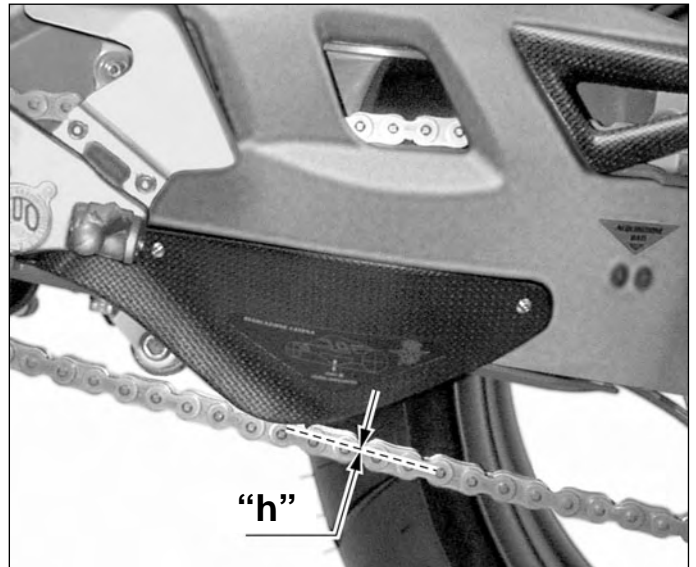



Maintenance

Adjust →

At the first 1000 kilometres and then every 6000 kilometres

B To adjust the chain tension, proceed as follows:
Slightly loosen the 2 screws of the back wheel hub until they can freely turn.



Using the special spanner as indicated in the figure, move the eccentric adjuster nut backwards or forwards respectively slackening or tightening the chain, until the correct play is reached (as described previously).



Successively tighten the screws of the rear wheel hub to the torque pressure indicated as follows.



Rear hub eccentric adjuster screw torque pressure: 28 ÷ 32 N·m

After tightening the screws of the rear wheel hub, recheck the chain tension so that any eventual variations can be found. If the tension of the chain is varied in respect of the adjustment before tightening the rear wheel hub, then repeat the adjustment procedure of the transmission chain.

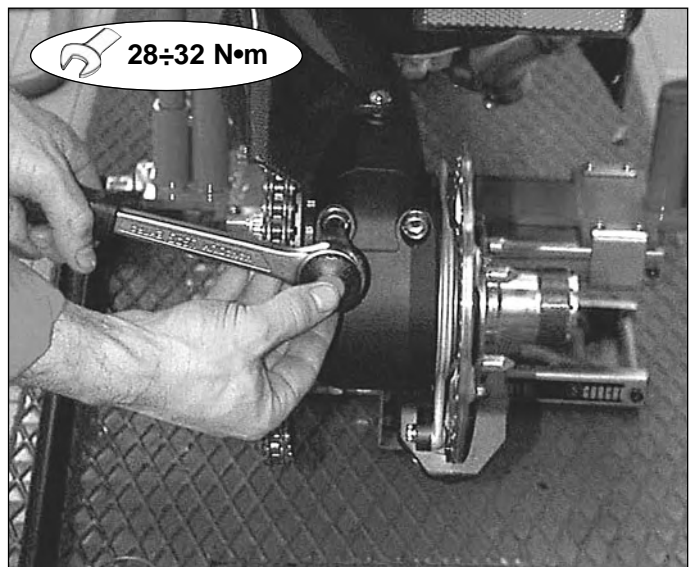



Maintenance

Chain lubrication

Lubricate → At the first 1000 kilometres and at 6000 kilometres and then at every 12000 kilometres

Clean the chain with a clean cloth and/or a jet of air.



The chain is the type with sealing rings (O-RING); in order to avoid damages you should not clean the chain using jets of steam or high pressure water, or using fuel or cleansing solvents on the market.

Then apply a light and even coating of lubricant on the whole chain without reaching the surrounding parts, in particular the tyres.



Use only the lubricant recommended (see page 11 in this chapter) in order to effectively protect the gearing chain and avoid from splashing when the motorcycle is running.

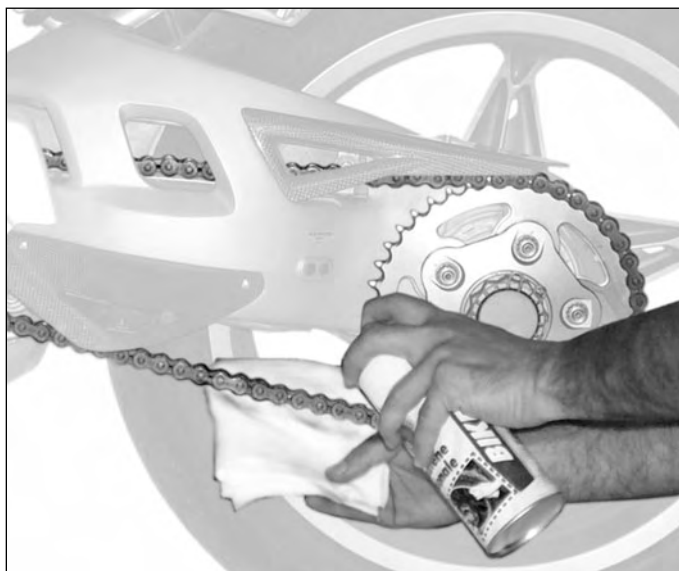
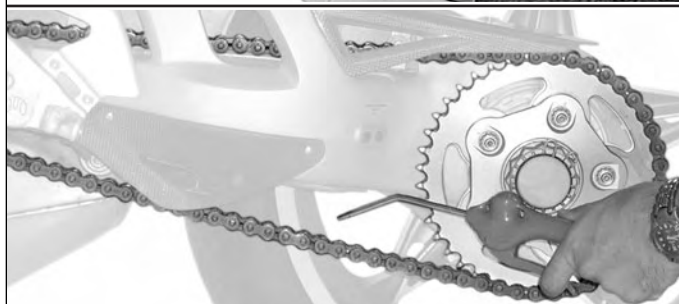

B



Maintenance

TYRES

Check pressures → At the pre-delivery, at the first 1000 kilometres and then every 6000 kilometres

Check wear → At the first 1000 kilometres and then every 6000 kilometres

If the tyre pressures are too high or too low, the ride is affected and tyre life duration is accentuated.

Therefore maintain the correct tyre pressures to obtain better roadholding and the maximum wear from the tyres. The cold tyre pressures are indicated in the table.

Description	BRUTALE ORO	BRUTALE S
Brand and type	DUNLOP - Sport Max D 207 Race Replica	PIRELLI - Dragon Evo MTR 21 Corsa (Ant.) / MTR 22 Corsa (Post.) PIRELLI Diablo Corsa MICHELIN Pilot Sport MICHELIN Pilot Power DUNLOP - Sport Max D 207 Race Replica
Inflation pressure (*)		
Front	2.3 bar (33 psi)	2.3 bar (33 psi)
Rear	2.3 bar (33 psi)	2.3 bar (33 psi)

The use of the motorcycle with excessively worn tyres diminishes the roadholding and is therefore dangerous. It is highly recommended to change the tyres when the tyre tread reaches the following minimum.



Ride with extreme care during the initial kilometres after replacing the tyres.

Utilise exclusively the tyres recommended.

Tyre tread minimum limit = 1.5 mm.

FRONT WHEEL BEARINGS

Check → Every 6000 kilometres and at every tyre change

Substitute → Every 36000 kilometres

If excessive play of the front wheel bearings is found during checks, then substitute them as indicated in chapter F "Suspension and wheels".

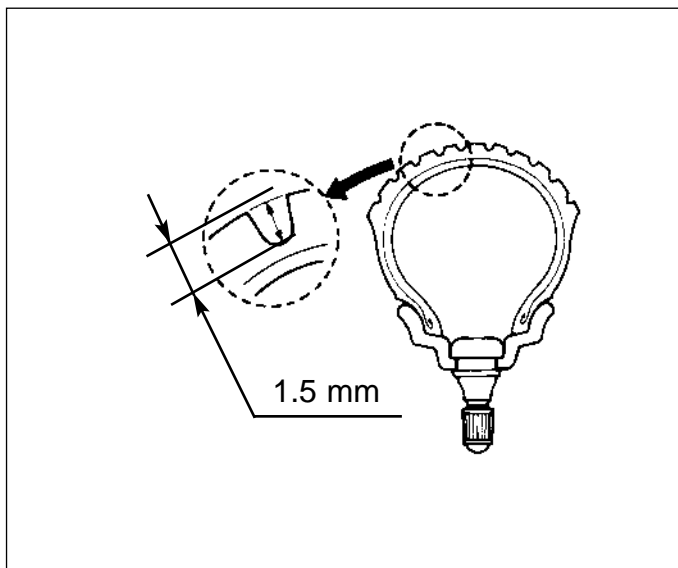



WHEELS

Visual check → At the first 1000 kilometres and then every 6000 kilometres (at least every tyre change)

After having visually checked or following even light collision damage, it is necessary to check the planarity, the eccentricity and the ovalisation of the wheel. See the control procedures described in chapter F “Suspension and wheels”.



B



REAR WHEEL HUB

- Check and lubricate bearings → Every 12000 kilometres
- Substitute → Every 12000 kilometres

To check and overhaul the rear wheel hub unit, it is necessary to carry out certain preliminary operations by consulting the relative chapters.

Remove the rear wheel (see chapter F "Suspension and wheels").

Lift up the motorcycle by utilising a mechanic's lift.

Remove the Seeger ring of the fixing nut of the crown flange (see chapter F "Suspension and wheels").

Loosen the nut of the wheel pin (see chapter F "Suspension and wheels").

Remove the brake caliper (see chap. H "Brakes") and its support flange.

Extract the wheel pin.

Check and overhaul the rear wheel hub unit (see chapter F "Suspension and wheels").

OSCILLATING ARM BEARINGS

- Check and lubricate → Every 36000 kilometres

If excessive play is found on the rear fork, due to the bearings assembled on the central pin of the fork/frame, substitute them as described in chapter F "Suspension and wheels".

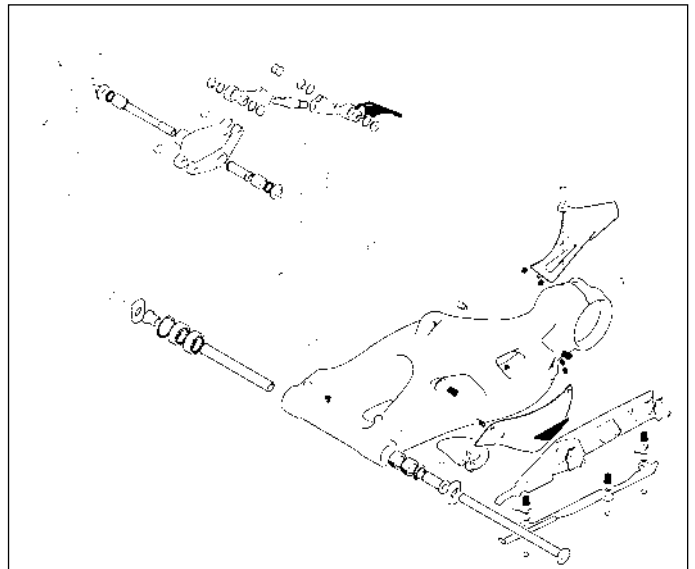
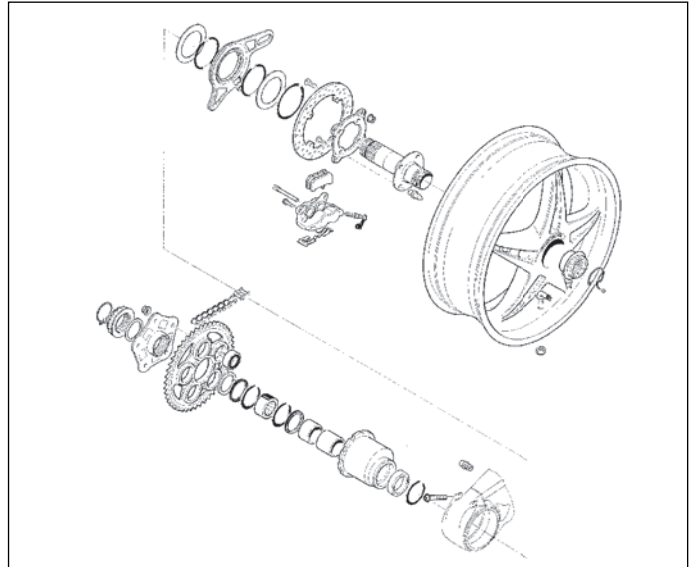

REAR SHOCK ABSORBER

- Check and adjust → At the first 1000 kilometres and then every 12000 kilometres

Verify the length in the seat of the back damper spring, check the absence of leakages or oil blow-by and the adjusting functionality.

Spring adjustment standard "A":

- Brutale ORO / Brutale S (MY 03):

A = 151 mm

- Brutale S (MY 04):

A = 154 mm

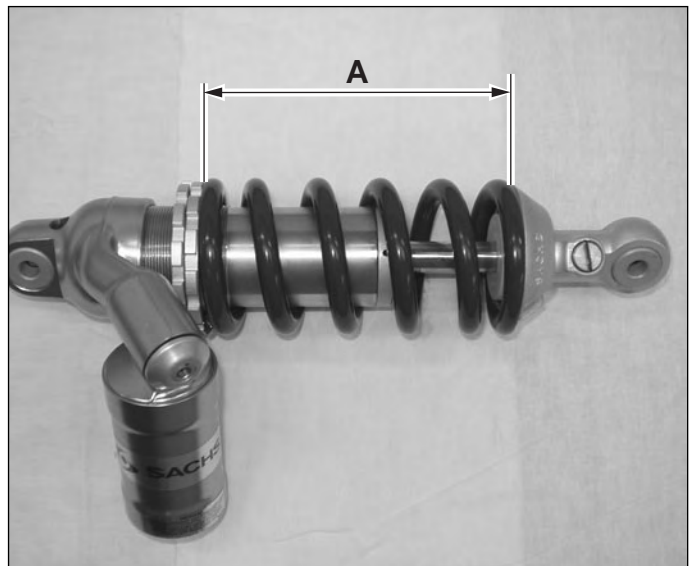

The shock absorber contains gas under high pressure. Do not touch the shock absorber valve. Do not attempt in any way to remove the shock absorber.



Maintenance

Compression and extension adjustment (rear suspension):

N.B. This operation can be made with the shock absorber in position on the motorcycle.

For further checks on the round joints where the rear shock absorber is attached, it is necessary to carry out the phases of removal described in chapter F "Suspension and wheels".

SIDE STAND

Functional check → At the pre-delivery, first 1000 kilometres and then every 6000 kilometres

With the side stand lowered, check that it is not possible to switch on the engine. Also check that with the engine switched on, when the side stand is lowered and a gear is engaged, the engine switches off automatically.

If not, the cause could be a faulty switch mounted on the side stand. If this is the case, substitute the switch by carrying out the following procedure.

Disconnect the electrical connectors.

Remove the 2 fixing screws of the switch.

Remove the switch.

After having substituted the switch, tighten the two screws to the prescribed torque.



Torque pressure: 5 ÷ 7 N·m

Apply Loctite Media 243

Reconnect the electrical connector.
Check that the side stand is not worn.

To remove the side stand, operate as follows:

- After having removed the side stand switch, unhook the two springs;
- remove the nut placed behind the hanger attachment;
- remove the screw (1).

For reassembling perform the operations in reverse tightening the nut complying with the prescribed torque.



Torque wrench setting of stand plate

screws (2):

25 ÷ 28 N·m



Torque wrench setting of hanger nut:

24 ÷ 28 N·m



Apply Loctite Media 243

The substitution of the springs must be carried out utilising the appropriate tool. Before refastening the springs, verify that the stand can freely turn (without damages or frictions).

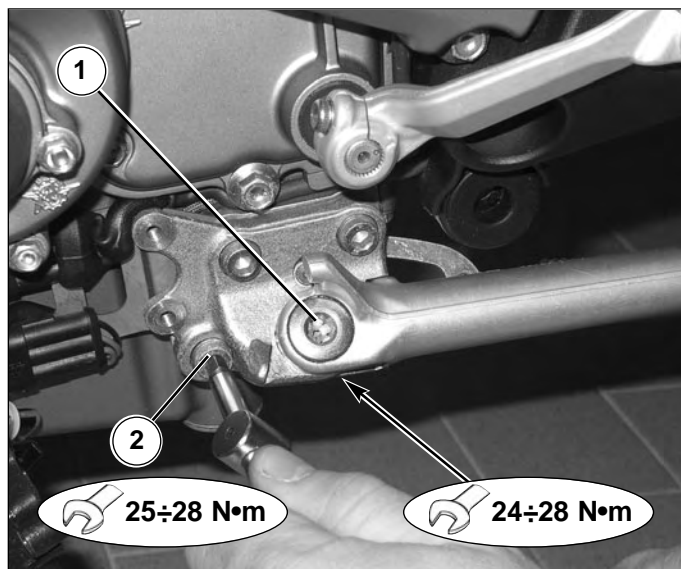
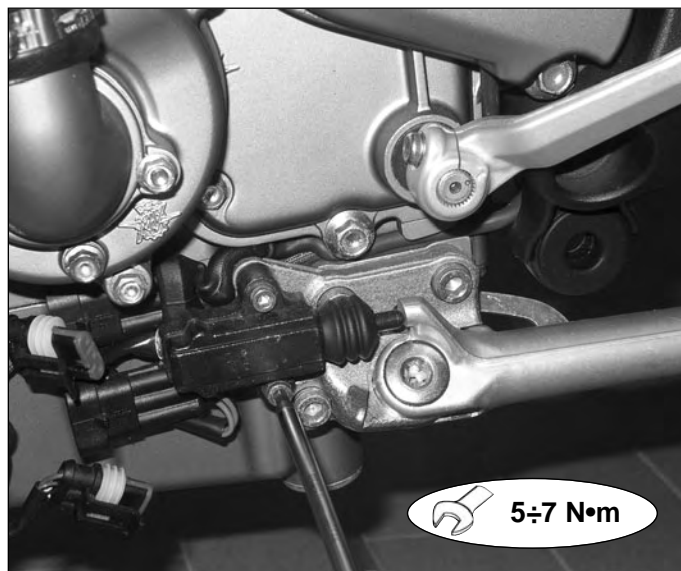
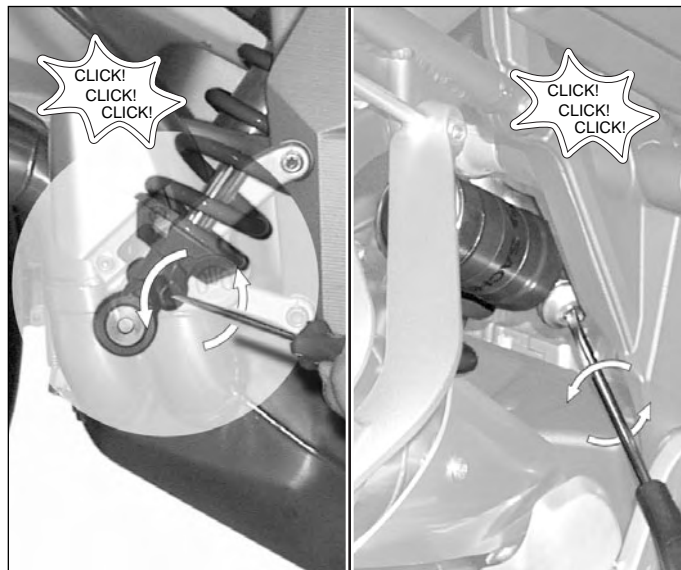



FRONT FORK

Substitute oil → every 24000 kilometres

The front fork is vitally important for the rideability and roadholding of the motorcycle. It is therefore necessary to substitute the fork oil at the prescribed intervals.



Quantity oil: about 655 cc

Specified oil:

- Brutale ORO / S (MY 03): SAE 5
- Brutale S (MY 04): SAE 7,5

To substitute the fork oil and to do a complete overhaul of the forks, carry out the described operations in chapter F "Suspension and wheels".

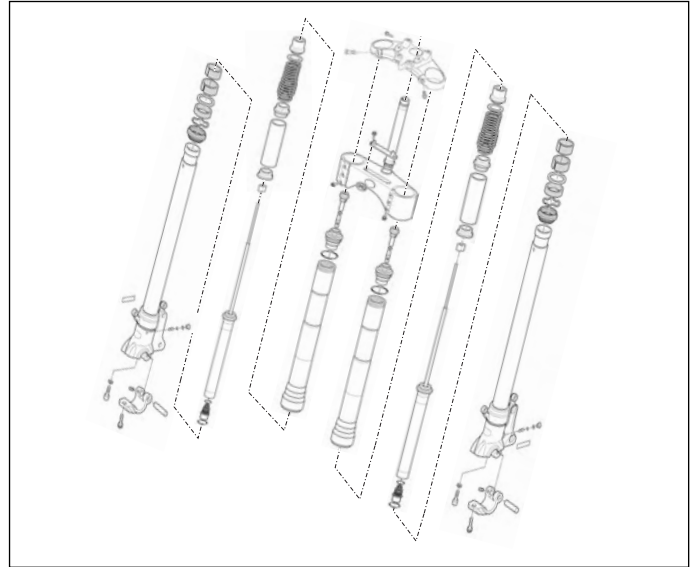

SCREWS AND NUTS

Check and tighten → At the pre-delivery, at the first 1000 kilometres and then every 6000 kilometres

Carry out an accurate check of the tightness of the nuts and screws on the motorcycle at the intervals prescribed. Consult the table in chapter N "Torque pressures" for the correct values".

TUBE BAND FASTENERS

Check and tighten → At the pre-delivery, at the first 1000 kilometres and then every 6000 kilometres

Carry out a general check on all tube band fasteners for their condition and tightness.

Substitute damaged band fasteners by following the relative procedure delineated in the various sections.



ELECTRICAL SYSTEM

Check the functioning → At the pre-delivery, at the first 1000 kilometres and then every 6000 kilometres

Carry out a detailed check on the various parts of the electrical system, the contacts between components and their good functioning.

Consult chapter E “Electrical system” for these checks.

BATTERY

Check and clean connections → at the first 1000 kilometres and then every 6000 kilometres

Consult chapter E “Electrical system” for the check on the battery condition.

If it is necessary to disconnect the battery and remove it during overhauls carried out on the motorcycle, follow the procedure in the figure for the correct assembly.

Insert the battery in the proper compartment.



The first charge of the battery must be performed before assembling it on the motorcycle.



Assembly of the battery terminals

Mount the two positive terminal (+) leads onto the relative pole of the battery, respecting the order indicated in figure. Pay attention to the colours of the cables in order to set them in the right way.





Maintenance

Turn the screw of the positive terminals and tighten them complying with the prescribed torque by using a torque wrench.

B Torque wrench setting: 7 ÷ 8 Nm

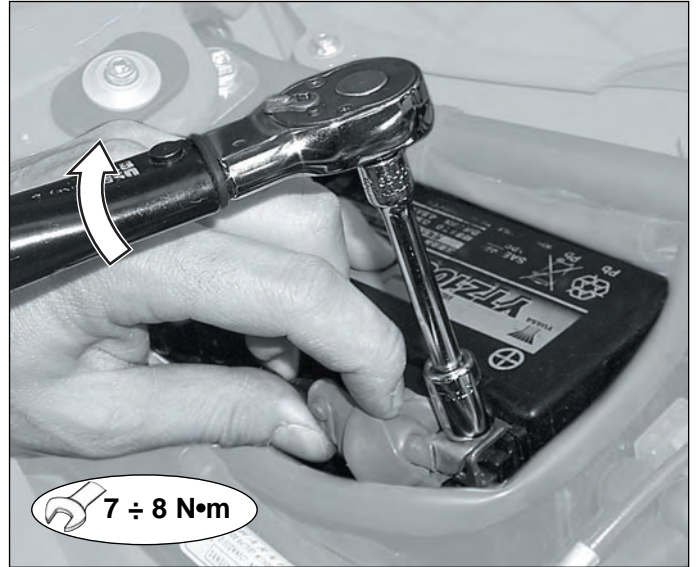

When the leads are mounted, replace the **protection cover** on the positive pole (see the figure).



Mount the two negative terminal (-) leads on the relative pole of the battery following the placement shown in the figure.





Maintenance

Turn the screw of the negative terminals and tighten them complying with the prescribed torque by using a torque wrench.

 Torque wrench setting: $7 \div 8 \text{ N}\cdot\text{m}$

 Before tightening, verify that the cables are correctly oriented.

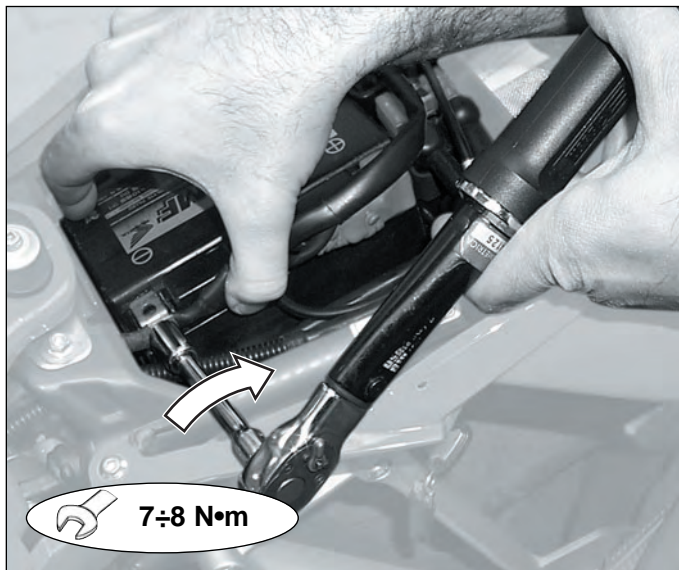

B

 At the end of assembly, ensure that the cable of the positive terminal is placed inside the structure of the back sub-frame (see the figure).

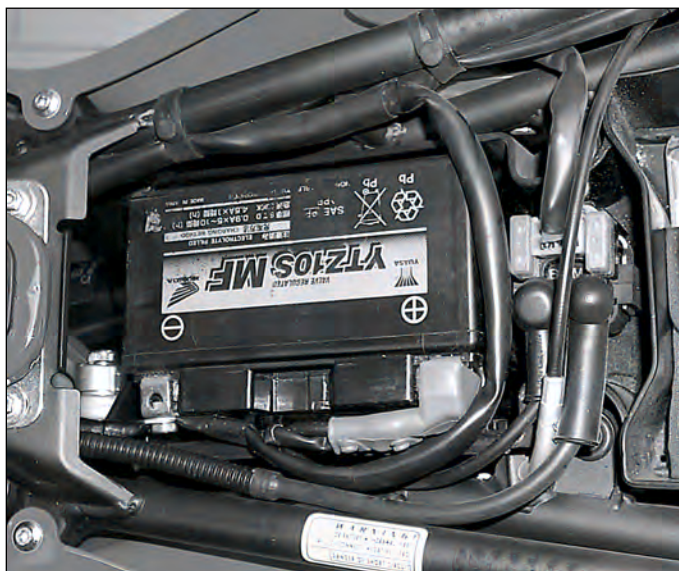

PLACEMENT AND ASSEMBLY OF TERMINALS (WIRE TERMINALS) ON THE BATTERY

NEGATIVE WIRE (-)

NEGATIVE POLE (-)

NEGATIVE WIRE (-)

 CAUTION: Before tightening, ensure that the wires are correctly oriented (see the figure)

POSITIVE WIRE (+)

 ATTENTION: After having finished the assembly, ensure that the positive terminal wire is placed inside the rear sub-frame structure (see the figure)

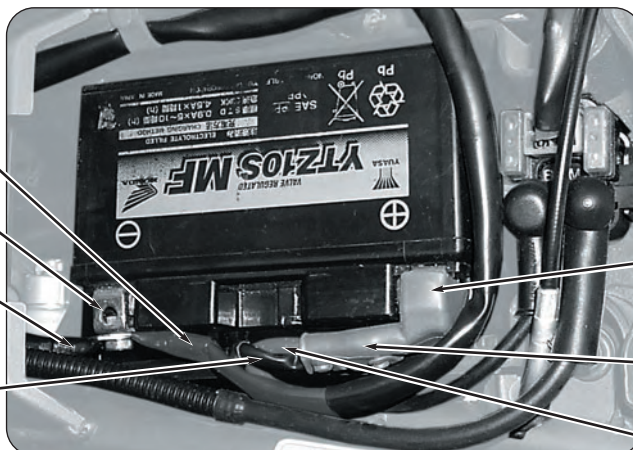

POSITIVE POLE (+)

PROTECTION COVER

POSITIVE WIRE (+)



INSTRUMENTS AND WARNING LIGHTS

Check → At the pre-delivery, at the first 1000 kilometres and then every 6000 kilometres

The instrumentation check must be carried out completely on all its functions as listed in the following list. If even one of the functions does not function correctly, consult chapter E “Electrical system” for complete details.

Turning the ignition key to the “ON” position activates the instruments and the warning lights. After an initial check-up (approximately seven seconds) the information received correspond to the general condition of the motorcycle at that moment.

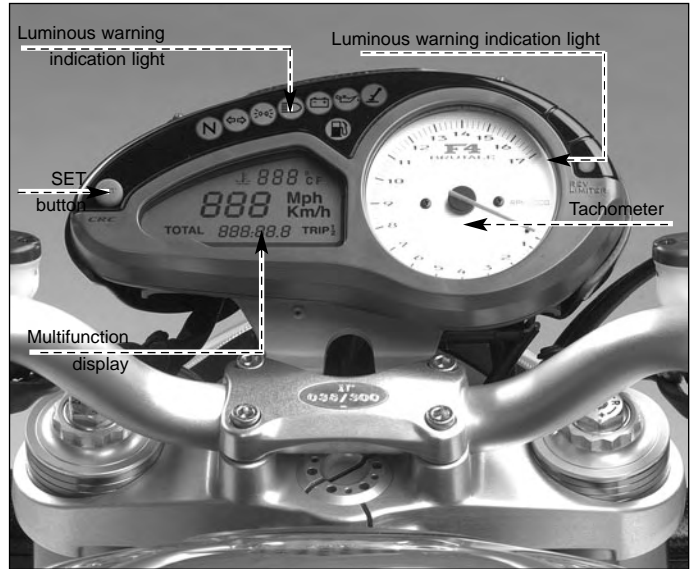

Luminous warning indication lights

1 Main beam warning light (blue)

It lights up only when the main beam is switched on.

2 Dipped beam or sidelights warning lights (green)

It lights up when the dipped beam or sidelights positions are activated.

3 Gears in neutral warning light (green)

It lights up when the gear position is in neutral”.

4 Direction indicators warning light (green)

It lights up when the direction indicators are activated.

5 Fuel reserve warning light (orange)

It lights up when the fuel tank contains approximately four litres of fuel.

6 Engine oil pressure warning light (red)

It lights up when the oil pressure inside the oil lubrication system is insufficient.

! If the oil pressure warning light lights up whilst riding the motorcycle, stop immediately. Check the oil level and if necessary top up. If the warning light lights up and there is a correct level of oil in the engine, do not continue riding. Contact the nearest authorised assistance centre.

7 Rev limiter warning light (red)

It lights up when the engine exceeds 12700 r.p.m. The limiter intervenes at 13100 r.p.m.

8 Side stand warning light (red)

It lights up when the side stand is in the lowered position.

9 Battery charge warning light (red)

It lights up when the alternator does not supply sufficient current to recharge the battery. If it lights up whilst riding the motorcycle, go to the nearest authorised assistance centre.

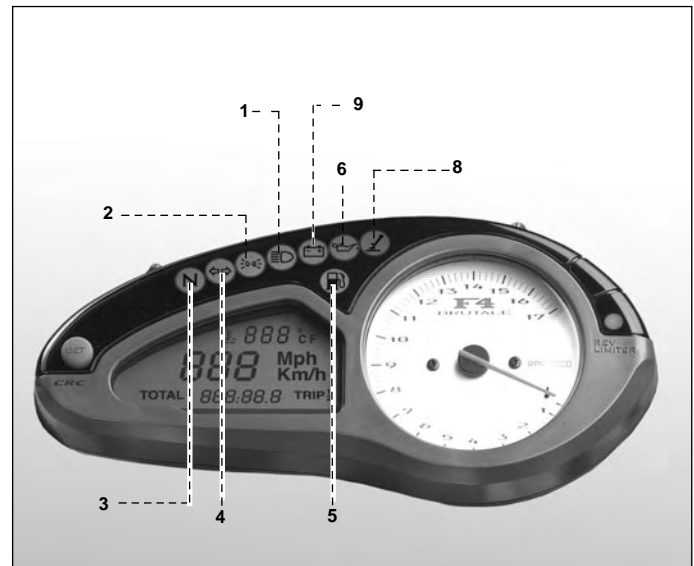



Multi-function display

10 Speedometer

The speedometer indicates the speed. The value of the scale can be written in kilometres per hour (k.p.h.) or miles per hour (m.p.h.). The highest value on the scale is 299 k.p.h. (185 m.p.h.).

11 “SET” button

If pressed, the “SET” button can select the figure of the display to effectuate adjustments. If pressed again, the figures are confirmed.

12 Total mileometer “TOTAL”

Indicates the total mileage, from 0 to 99999.9 (kilometres or miles).

Partial tripmeter 1 “TRIP 1”

Indicates partial mileage, from 0 to 9999.9 kilometres or miles.

Partial tripmeter 2 “TRIP 2”

Indicates partial mileage, from 0 to 9999.9 kilometres or miles.

Clock

Indicates the time (0 - 24).

13 Thermometer

Indicates the temperature of the engine coolant. The value can be in centigrade (°C.) or in Fahrenheit (°F.).

The temperature field goes from 40°C. to 140°C. (104°F. to 284°F.):

- under 40°C. (104°F.) the indication does not appear. Three flashing lines appear which means that the temperature signal is very low.;
- between 40° and 49° C (104° and 120° F) the indication flashes which means that the temperature is low;
- between 50°C. and 105°C. (122°F. and 221°F.) the indication is fixed;
- between 106°C. and 140°C. (223°F. and 284°F.) the indication flashes which means that the temperature is too high.

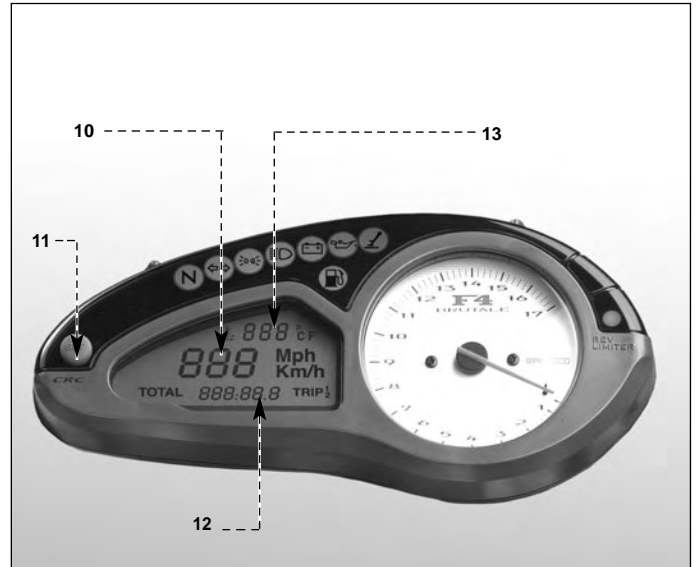

B



Attention: if the temperature is over 120° C (248° F), stop the motorcycle and check the coolant level and the fan running on the right side of the radiator. If it is necessary to top up the coolant, wait for the cooling of the engine. Non aprire il tappo di carico del liquido di raffreddamento a motore caldo. If the temperature indicator continues to mark values higher than 120° C (248° F) even if the level is correct and the fan works, not proceed running and contact an authorized assistance centre.



Maintenance

Modifications to the display functions

Modifications can be made to the clock function, the tripmeter function and the thermometer function. This operation must be effectuated with the engine switched on and the gears in neutral.

Clock (hours and minutes)

Repeatedly press the starter button until the visualisation of the hour appears.

Pressing the “SET” button, the first figure of the hour starts to flash.

Press the starting button to adjust the digit; release when the desired digit is reached.

N.B. To obtain the quick scrolling of the selected digit, press and hold the engine starting button more than two seconds.

Repeat the procedure for the second figure of the hour, for the first and second figures of the minutes.

Press the “SET” button to confirm the figures and to interrupt the selection (the flashing).

Speedometer (k.p.h. – m.p.h.)

Repeatedly press the starter button until the visualisation of the “TOTAL” speedometer function.

Press the “SET” button. The measuring unit of the speedometer starts to flash.

N.B. The instrumentation has an integral memory which stores all parameters also when the engine is off. Except for the clock, which is set to zero, all parameters are in memory also in case of battery disconnection.

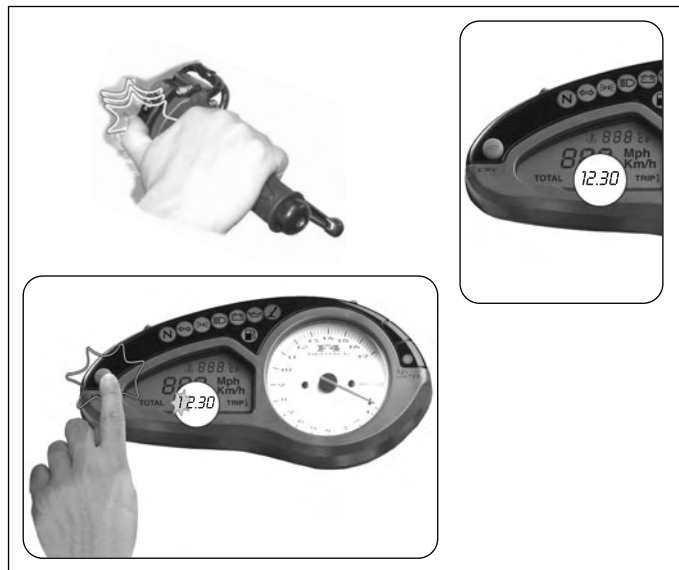



Maintenance

Press the starter button to pass from kilometres per hour to miles per hour and vice versa. Varying the measuring unit of the speedometer automatically varies also the mileometer (total and partial).

Press the "SET" button. The measuring unit of the thermometer starts to flash. Proceed to the successive adjustment.



Thermometer (°C. - °F.)

Press the starter button to pass from °C. to °F. and vice versa.

Press the "SET" button to confirm the measuring unit.



Display function selection

The selection of the "TOTAL" mileometer, the partial "TRIP 1" mileometer, the partial "TRIP 2" mileometer and the clock must be carried out with the engine switched on.

Repeatedly pressing the starter button, the functions appear in a cyclic mode.



Resetting of the tripmeters

The values of the "TRIP 1" and "TRIP 2" can be reset as follows.

B Press the starter button to activate the "TRIP 1".

Press the starter button for more than four seconds. The value will start to flash.



Press the starter button for less than four seconds; the value zeroes. If instead the starter button is pressed for more than four seconds, the resetting procedure is interrupted.

Pressing the engine starting button, activate the function "TRIP 2".



Press the engine starting button for more than four seconds; the value starts to blink.

Now pressing the engine starting button for less than four seconds the value is set to zero.

If you press the engine starting button for more than four seconds the zero setting is interrupted.





LIGHTS

Check → At the pre-delivery, at the first 1000 kilometres and then every 6000 kilometres

If any of the warning lights or the main lights are burnt out, replace them as follows.

Dipped headlamp – bulb substitution

Remove the two side fixing screws **(1)** of the front headlight.

Pay attention to take out the register from the proper seat when the headlamp is removed from the support.



Before removing the front headlight from its support, disconnect the connector **(2)** placed on the back of the headlamp.

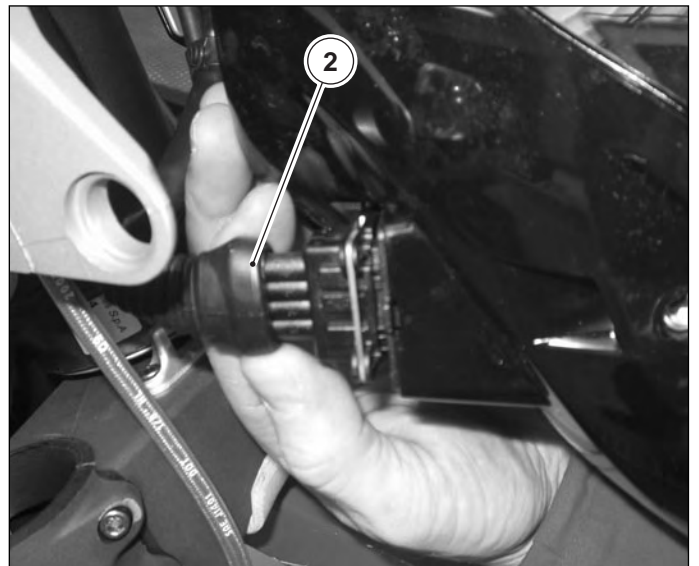



Maintenance

Put the headlamp on a table in order to perform the following operations.

Remove the back screw of the headlamp.

Remove the front part of the headlamp from its support shell.



Disconnect the connector of the dipped headlight.

Remove the protection cover.

Release the check spring.



Extract the bulb of the dipped headlight.



Do not touch the glass of the bulb with your hands. In case of contact clean using a degreasing product.

Insert the new bulb.

Refasten the check spring.

Place the protection cover again.

Reconnect the connector of the dipped headlight.

Reassemble the front part of the headlamp from its support shell.

Retighten the back screw.

Reinsert the connector of the headlamp.

Place the headlamp on its support again and retighten the two side fixing screws, watching to reinsert the register in its seat.





Dipped headlight – Replacing bulb

Turn the bulb of the dipped headlight counterclockwise and extract it from its seat.

Disconnect the connector from the bulb.

 **Do not touch the glass of the bulb with your hands. In case of contact clean using a degreasing product.**

Insert the connector in the new bulb.

Reinsert the bulb in its seat and set it turning counterclockwise.

Reassemble the headlamp on its support.

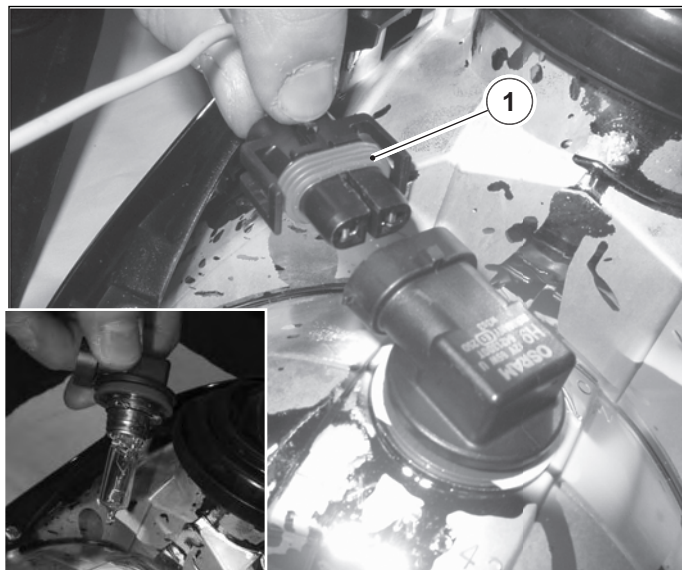

Front lights – Replacing bulb

Remove the front headlamp from its support.

Turn the lamp holder counterclockwise and extract it from its seat.

Extract the bulb removing it from lamp holder.

 **Do not touch the glass of the bulb with your hands. In case of contact clean using a degreasing product.**

Insert the new bulb.

Reinsert the lamp holder in its seat and set it turning counterclockwise.

Reassemble the headlamp on its support.



Front direction indicators – bulb substitution

Remove the fixing screw.

Remove the glass.





Maintenance

To extract the bulb press it counterclockwise.
Insert the new bulb pressing and turning it clockwise.
Reassemble the glass and retighten the fixing screw.

B



Rear direction indicators – bulb substitution

Remove the fixing screw.

Remove the glass.

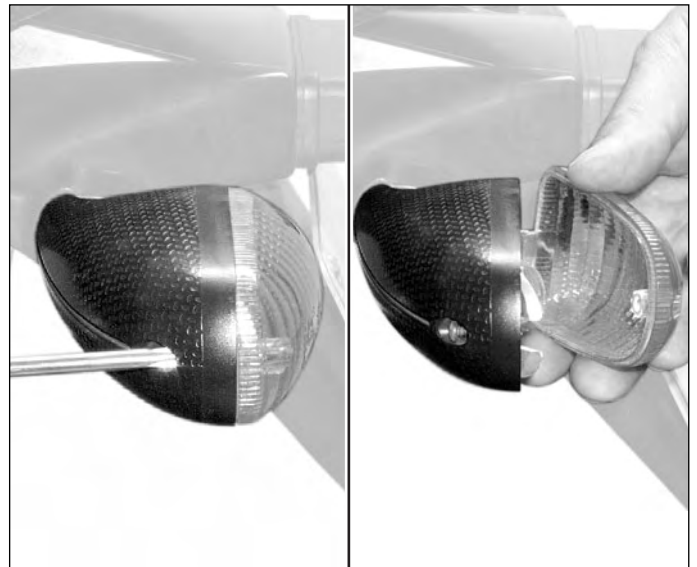

To extract the bulb press it counterclockwise.
Insert the new bulb pressing and turning it clockwise.
Reassemble the glass and retighten the fixing screw.

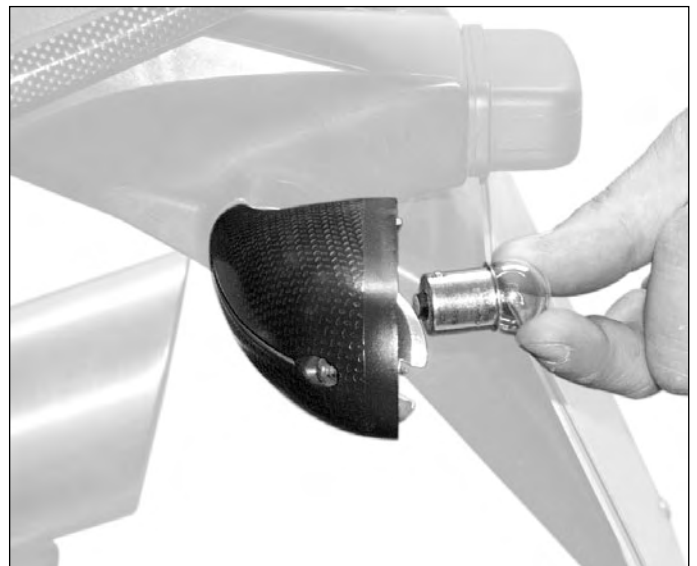



Rear light/stop light – bulb substitution

Lift the passenger seat.

Extract the bulb holder, rotating it in an anti-clockwise direction.



To extract the bulb, press it down and rotate it in an anti-clockwise direction.

Insert the new bulb pressing and turning it clockwise. Reinsert the bulb holder and rotate it in a clockwise direction.



Number plate light – bulb substitution

Remove the fixing screws of the cable guide.





Maintenance

Following the procedure shown in the figure, lower the cable guide separating it from the upper supporting surface.

B



Extract the lamp holder of the number plate light from its seat.

Extract the bulb taking it out from the lamp holder.

Insert the new bulb.

Reinsert the lamp holder.

Place the cable guide again into contact with the upper supporting surface.

Retighten the fixing screws of the cable guide.



Fuses – Substitution

The recharge fuse is under the rider seat as shown in the figure.

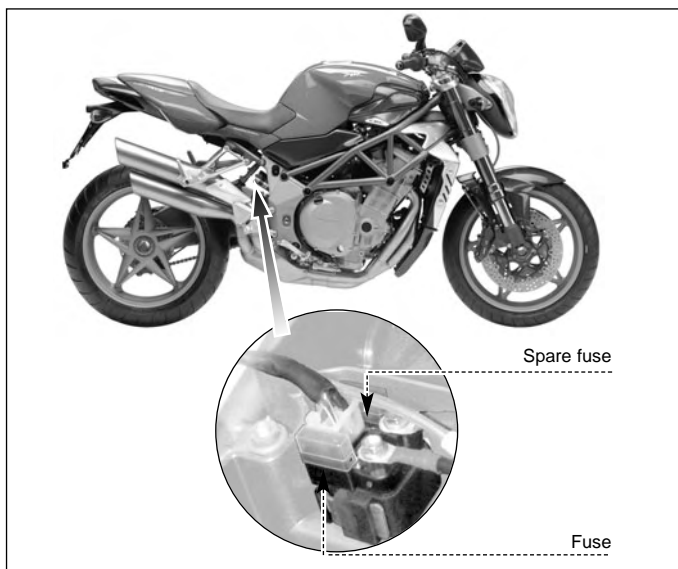



Maintenance

The fuses are situated on the right side of the motorcycle; to reach them you should disassemble the right side panel fixed on the tank.



Remove the cover.



Turn the ignition switch on "OFF" before checking or replacing the fuses in order to avoid accidental short circuits with consequent risk to damage other electric components.

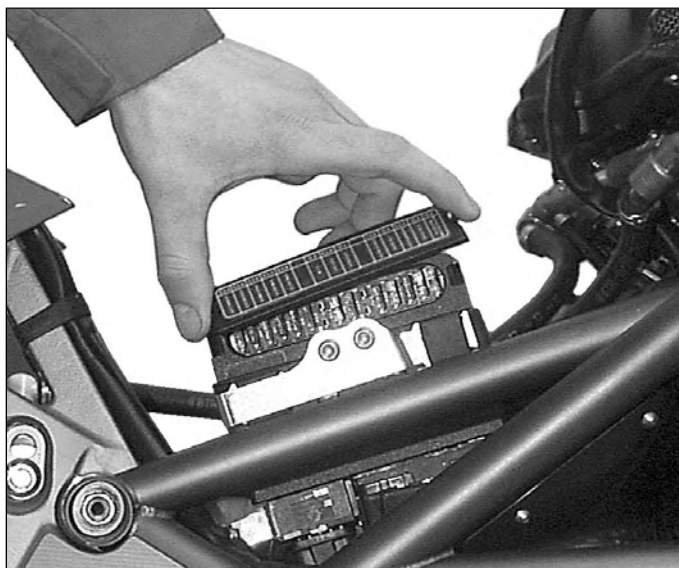

To identify the position and the function of the fuses, consult the information on the adhesive label and the electrical system. The reference letters indicated in the figure correspond to those shown in the electrical diagram.

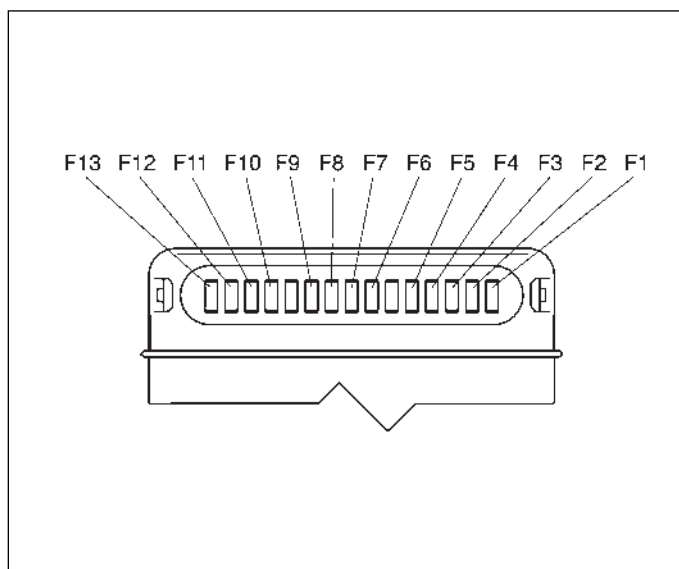

Replace the burnt fuse and reassemble the cover. Remember that two spare fuses are available in the toolkit.

B

Never use a fuse having an adjustment different from the instructions in order to avoid from damaging the electrical system of the motorcycle with the consequent fire risk.

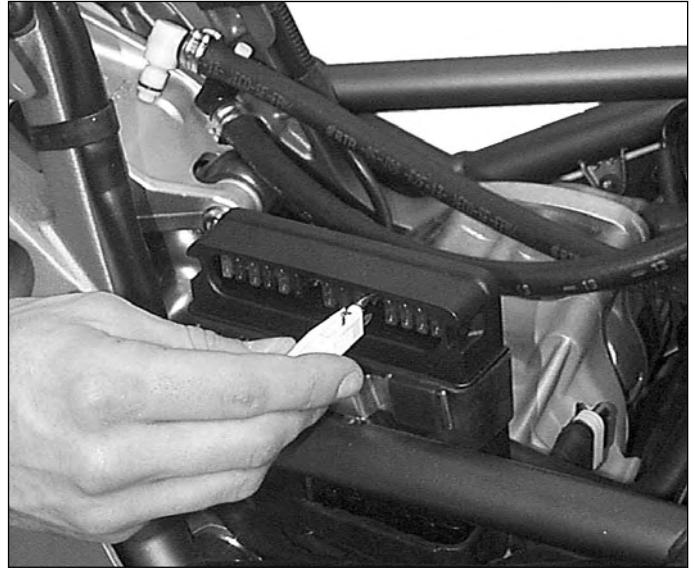

FRONT HEADLAMP

Check adjustment – At every variation of the motorcycle set-up

Each time a variation to the set-up of the motorcycle is carried out, it is good practice to carry out the adjustment of the headlamp beam.

The adjustment of the front headlight can be performed operating the screw shown in the side figure. Clockwise: the headlight leans downward. Counterclockwise: the headlight leans upwards. The inclination can be varied for $\pm 4^\circ$ in respect of the standard position.



Adjusting front headlight

Place the motorcycle 10 metres from a vertical wall.

Ensure that the ground is even and that the optical axis of the projector unit is perpendicular to the wall.

The motorcycle must be in a vertical position.. Measure the height of the centre of the beam from the ground and mark it with a cross on the wall using a piece of chalk.

Switch on the dipped beam. The upper demarcation limit between the dark zone and the illuminated zone must be not more than 9/10ths of the height from the ground of the centre of the beam.

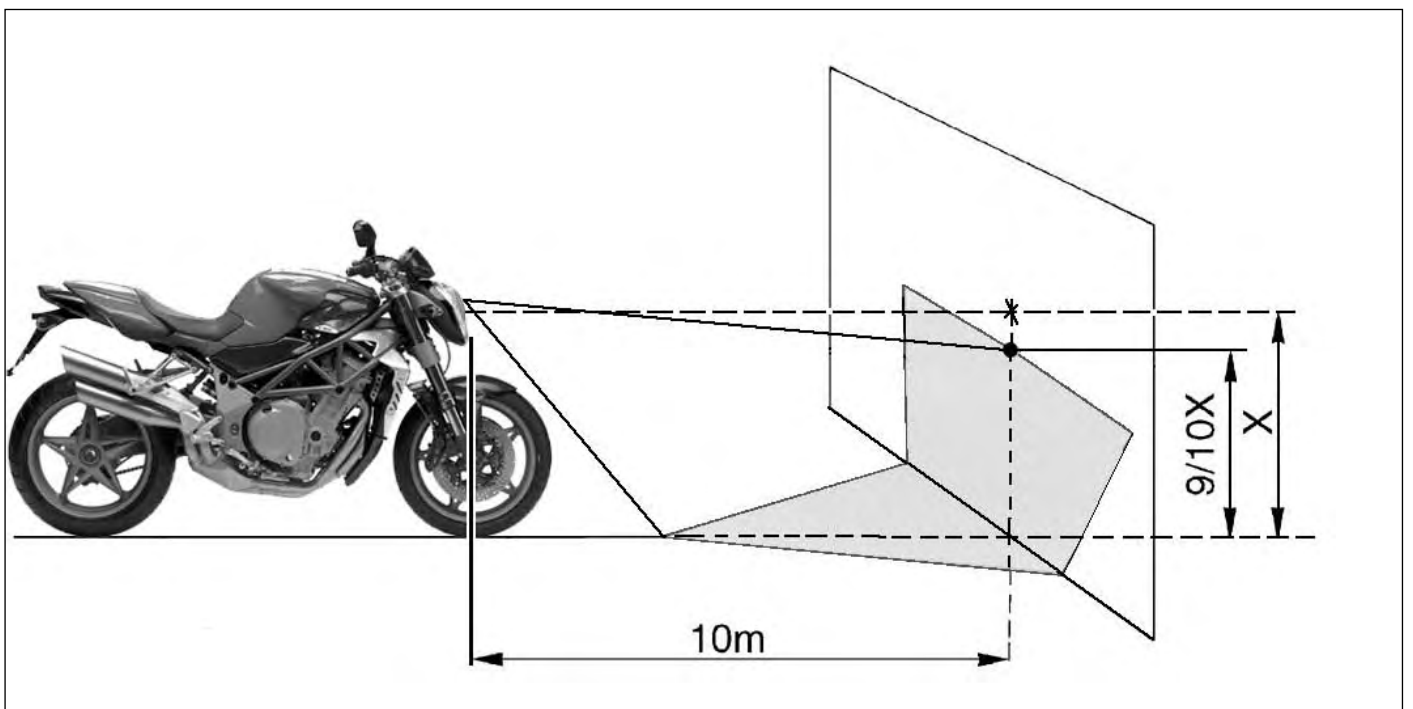
B



Maintenance

B



Bodywork

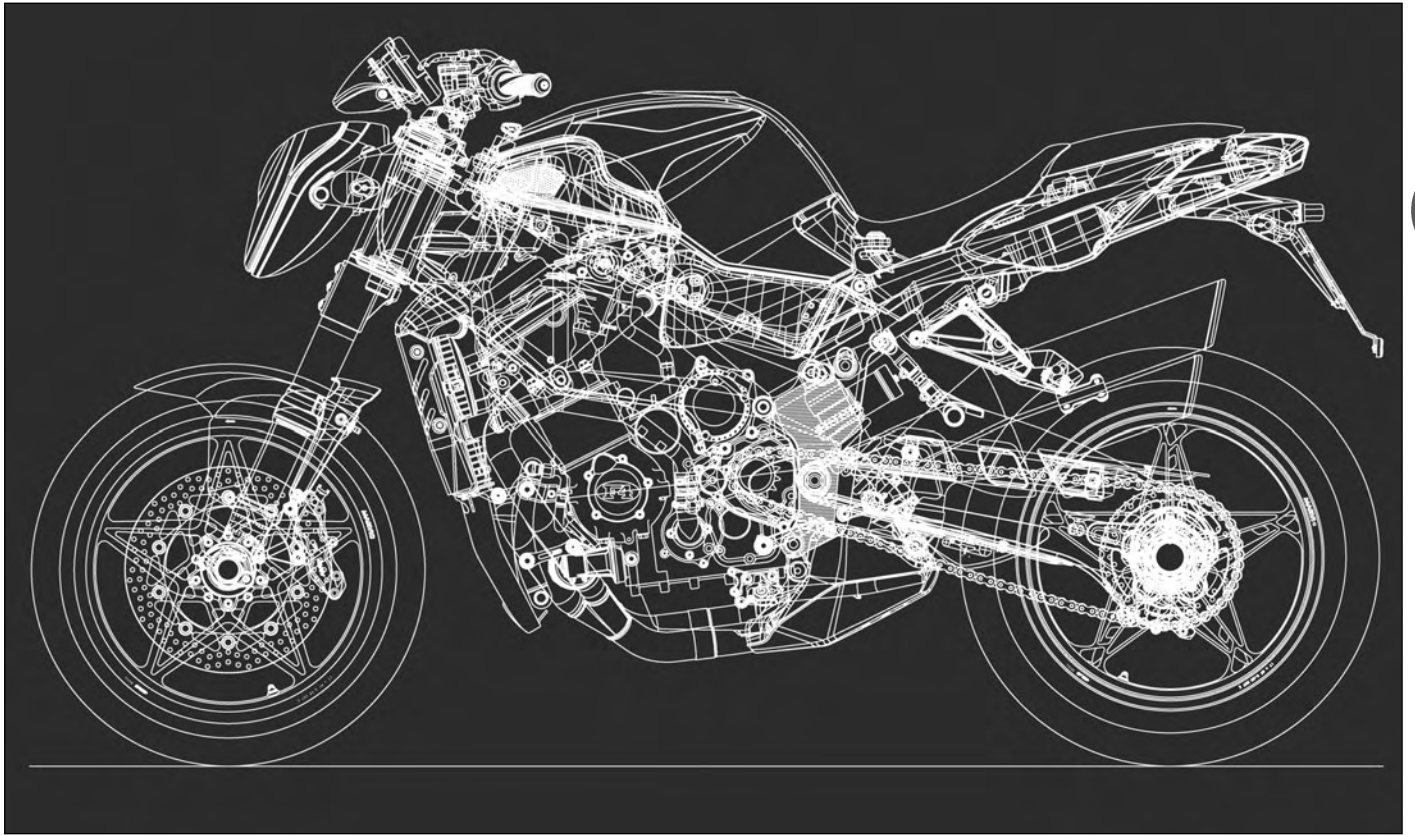

C

SECTION C
Revision 0



SUMMARY

FAIRING ASSEMBLY	Page 3
DISASSEMBLING FRONT HEADLAMP	Page 4
DISASSEMBLING INSTRUMENTATION PANEL	Page 5
DISASSEMBLING HANDLEBAR	Page 6
DISASSEMBLING HEADLIGHT SUPPORT	Page 7
FUEL TANK.....	Page 8
DISASSEMBLING FUEL TANK SIDE PANELS	Page 9
FUEL TANK REMOVAL	Page 10
AIR FILTER COMPARTMENT.....	Page 15
AIR FILTER COMPARTMENT REMOVAL	Page 16
TAIL UNIT.....	Page 20
TAIL UNIT REMOVAL	Page 21
UNDER-TAIL ASSEMBLY	Page 24
DISASSEMBLING UNDER TALE UNIT	Page 25

FAIRING ASSEMBLY

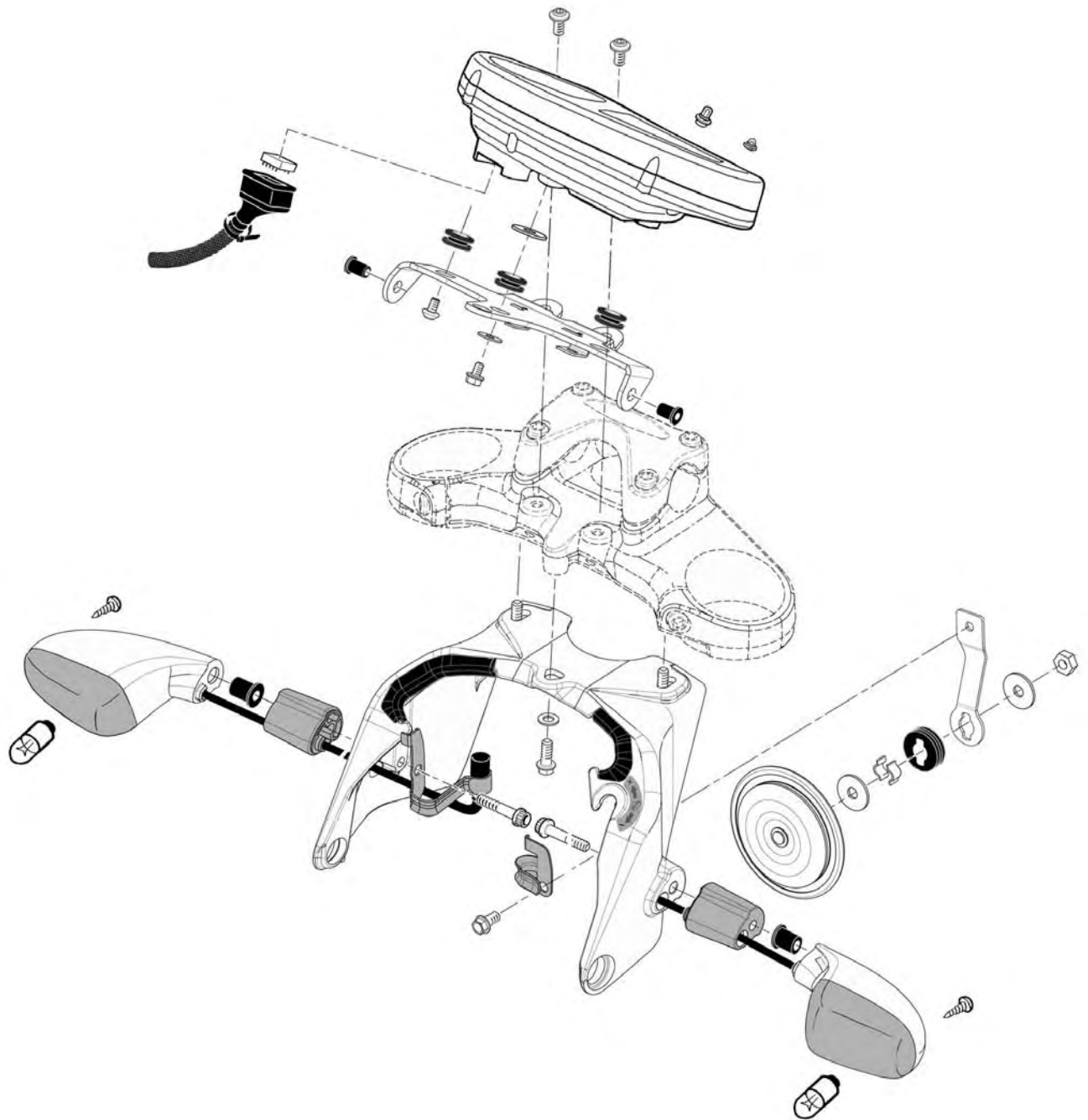

C

DISASSEMBLING FRONT HEADLAMP

Disassemble the two fixing screws of the headlamp.



Release the headlamp from the support for the luminous beam height control.



Disconnect the electric connection (1) and remove the headlamp.

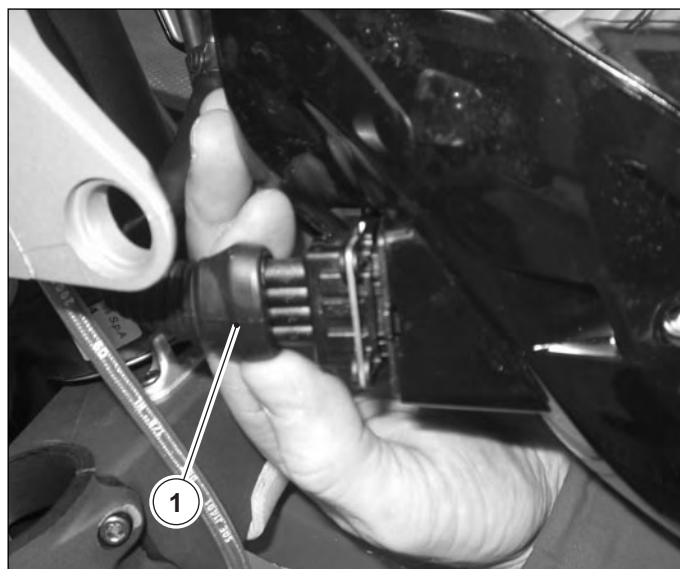

DISASSEMBLING INSTRUMENTATION PANEL

Unscrew the fixing screws and remove the instrumentation panel cover by acting in the shown direction.

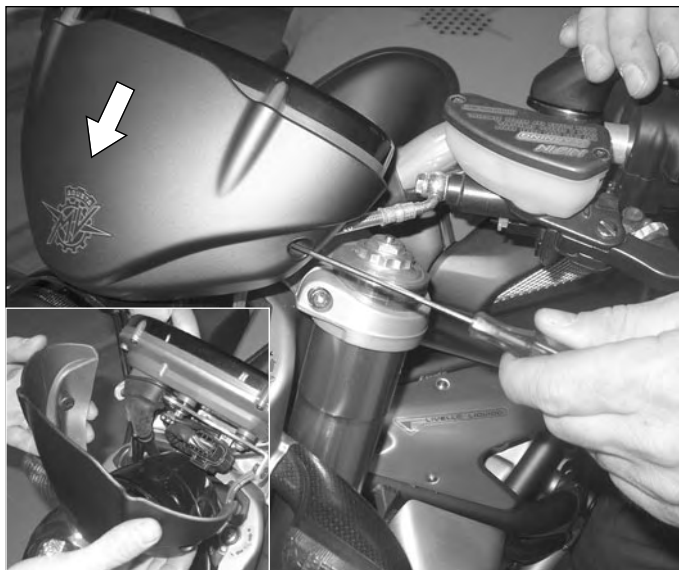

Release the connector (1).



Unscrew the fixing screw of the instrumentation panel and withdraw it from the support.



DISASSEMBLING HANDLEBAR

Before performing this operation, you should preliminarily carry out the disassembling of the front headlight and the instrumentation panel as described in the previous pages.

Disconnect the connectors.



Withdraw the wiring from the headlight support hooks.



Disconnect the warning horn.





Bodywork

Unscrew the four fixing screws of the handlebar U bolt.



Remove the handlebar with the U bolt.



During the reassembly, you should pay attention to the right positioning of the U bolt in regard to the handlebar. This is made using a pin that you have to insert in the right seating of the handlebar.



Torque wrench of the U bolt handlebar fixing screws: 20 N•m

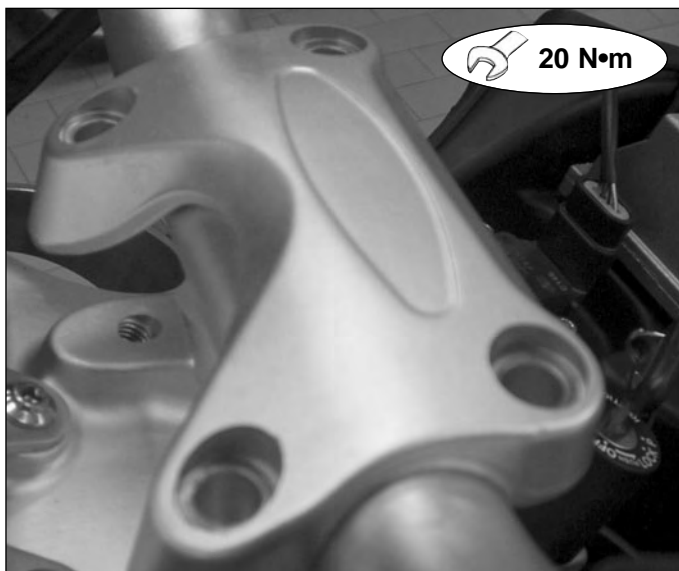

DISASSEMBLING HEADLIGHT SUPPORT

Unscrew the three fixing screws and remove the support.

For reassembling, perform the following operations:

- Apply the breakthread "Loctite 243" on the threaded part of the three fixing screws.
- Position the headlight support under the steering base and insert the three fixing screws with the washers without tightening.
- Push lightly the headlight support towards the back part of the motorcycle until the screws are into contact with the slot rims of the headlight support.
- Tighten the fixing screws.



Torque wrench of the headlight support screws: 8 ÷ 10 Nm



Specific product: LOCTITE 243



FUEL TANK

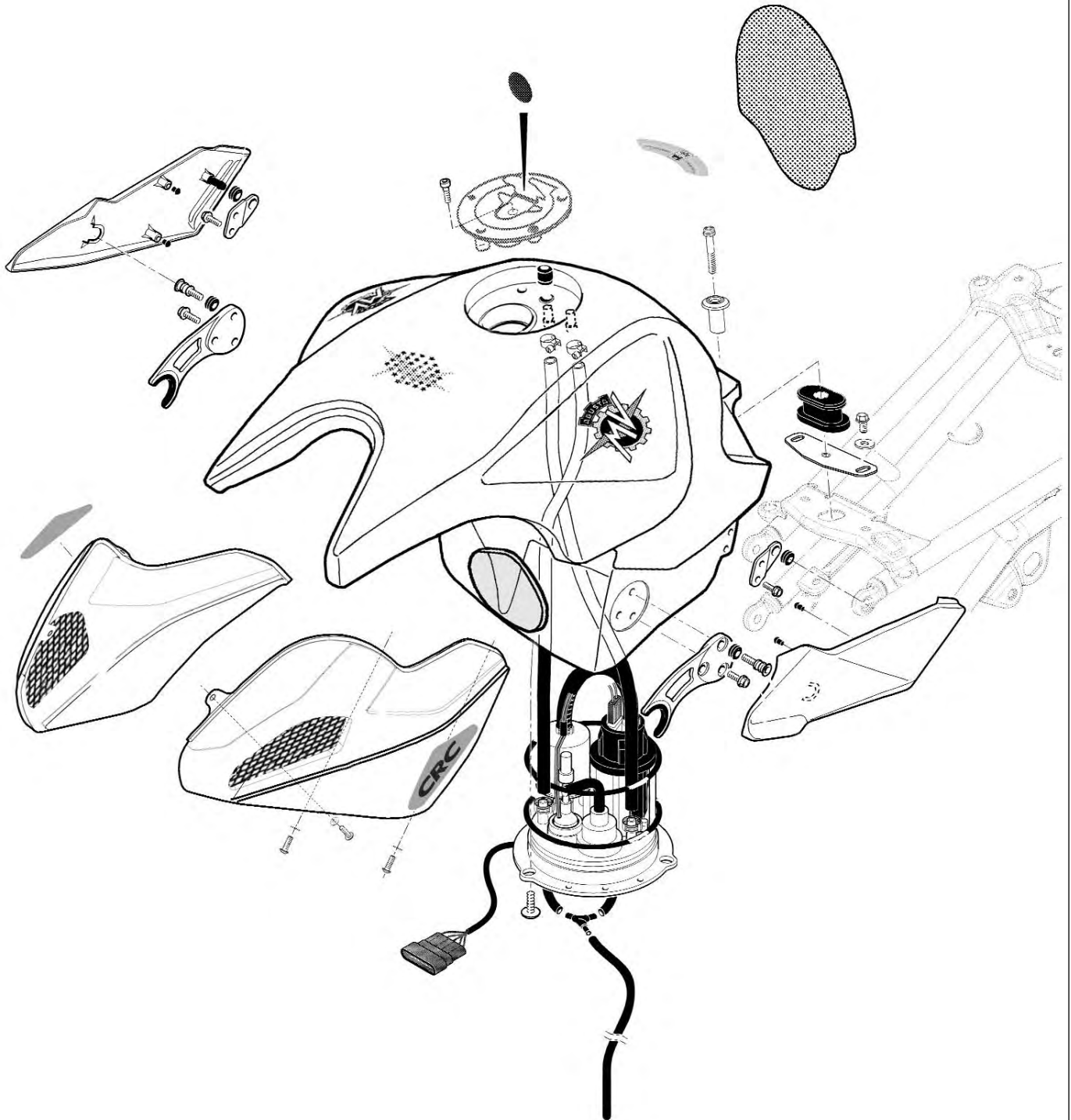



Bodywork

Before removing the fuel tank you should preliminarily remove passenger and rider seats as described at the paragraph "Disassembling tale unit" of this chapter.



Remove the ignition commutator protection by unscrewing the two fixing screws (1).



DISASSEMBLING FUEL TANK SIDE PANELS

Operate on the left side of the motorcycle.
Release the trailing part of the left side panel by releasing the peg (A) from its seat (B) on the rubbered support, fastened in the rear part of the tank, making it accomplish the movement shown in the figure.

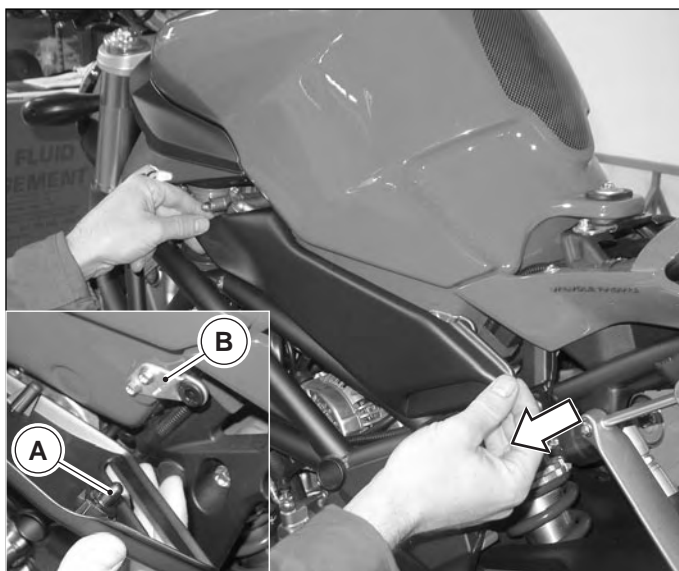

Release definitely the side panel by moving it towards the rear part in order to release it from the special rubbered screw (1) fastened to the fuel tank.

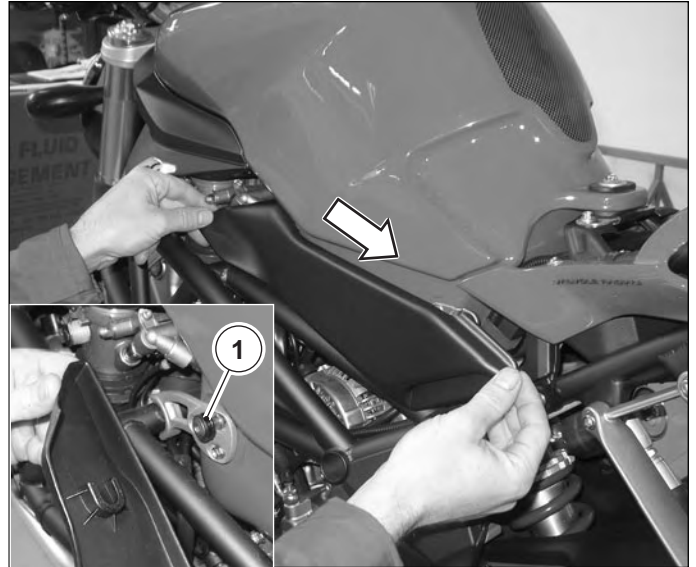

Make the same operations in order to remove the right side panel.



FUEL TANK REMOVAL

Unscrew and remove the special rear fixing screw (1) of the fuel tank to the rear sub-frame.



Operate on the right side. Unscrew and remove the special rubbered screw (1) on the tank support.

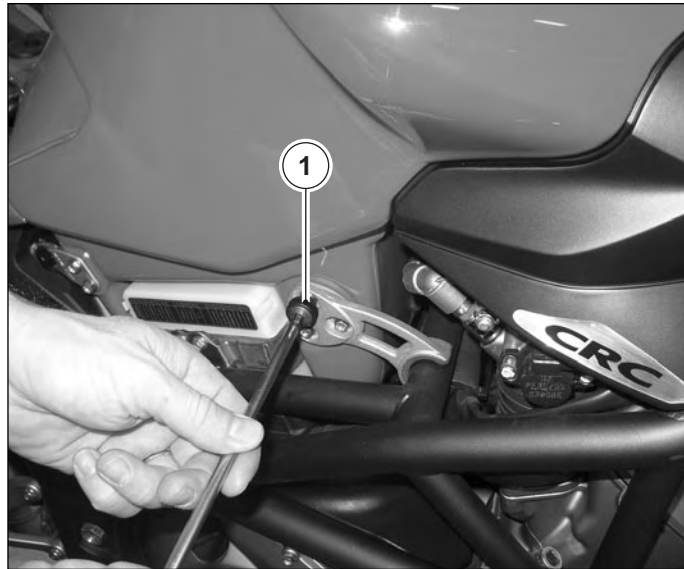

Unscrew and remove the two support fixing screws (1) of the tank support.

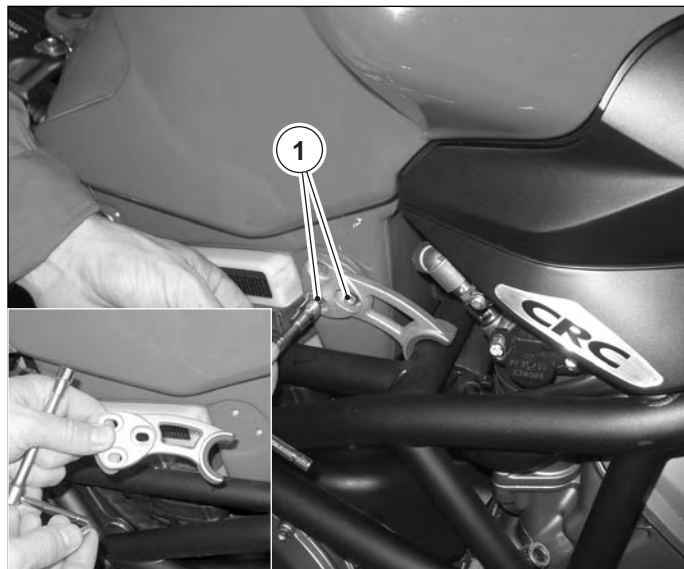

Make the same operations on the left side of the motorcycle in order to remove the tank support.





Bodywork

Lift and lean the fuel tank on a side in order to easily work on the rapid unions on the fuel pump flange.

N.B. In order to make the unions disengagement operation from the fuel pump flange easier it's recommended the presence of two operators, one that works on the tank support and the other on the rapid unions release.



Release the rapid unions (1).

 Pay attention to any fuel leakages, put a rag in order to protect the underlying parts.

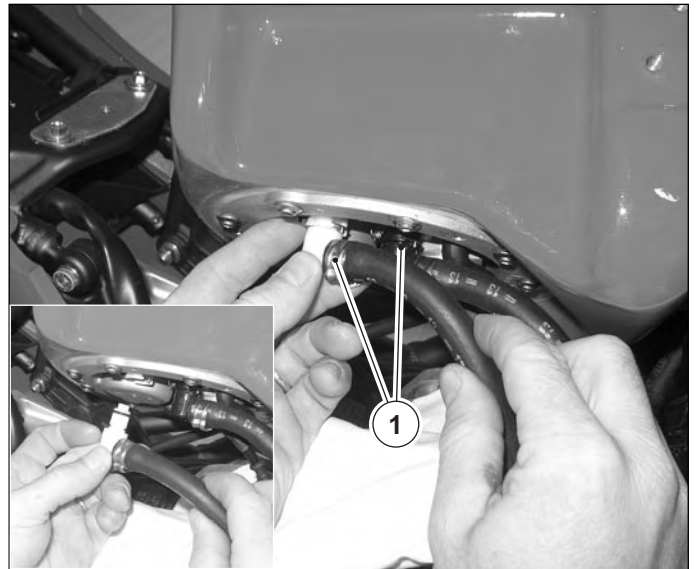

 The release of the fuel tubing occurs when you press the held seat on the union as you can see in the figure.



In case of replacement of the rapid clutch terminals indicated in the figure, apply Loctite 577 on the threaded part respecting the terminal phasing when you are tightening them.

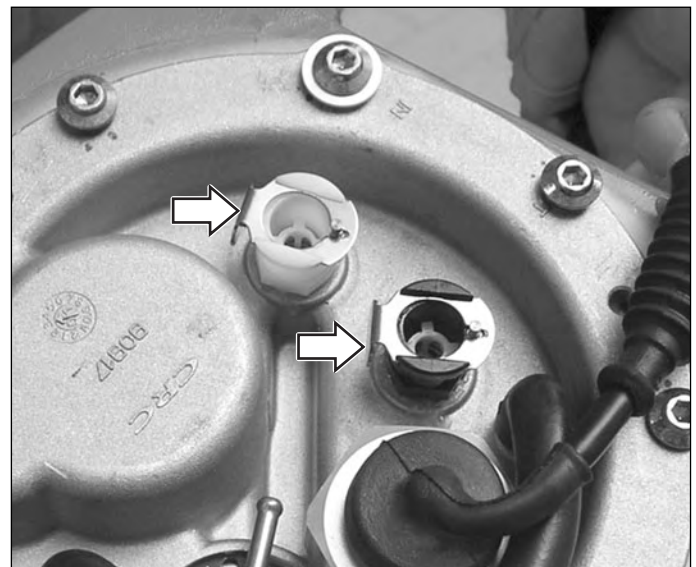



Bodywork

Disconnect the connector of the fuel flange pump (1) of the main wiring.

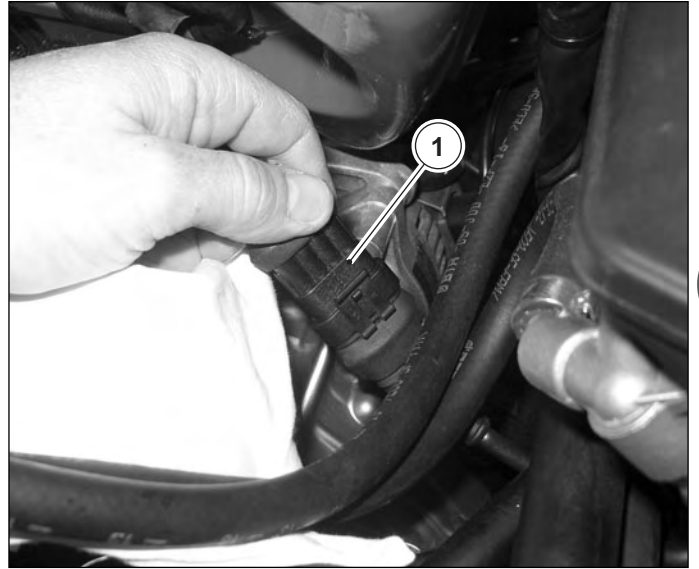

Withdraw the fuel breather pipe (1) connected to the three-way union.

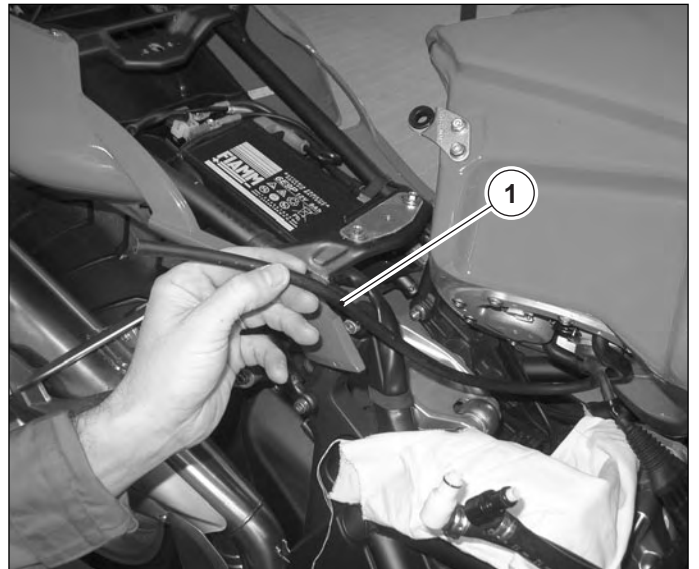

Removing of the fuel tank plug

Insert the motorcycle key in the fuel plug lock, rotate clockwise and open the plug.



Unscrew and remove the three screws (1) and the safety screw (2).

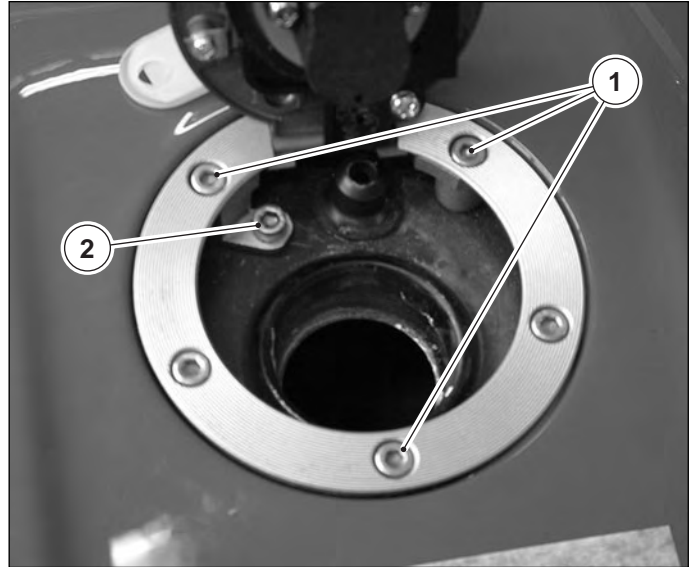

During the reassembly of the fuel tank plug make the same operations in the opposite direction in regard to disassembling ones by tightening them at the described torque and apply the indicated brakethread.



Fuel filler cap fixing screws torque pressure:

- External screws: $5 \div 7 \text{ N}\cdot\text{m}$



- Fuel tank plug:
Apply Loctite 243 and screw in lightly

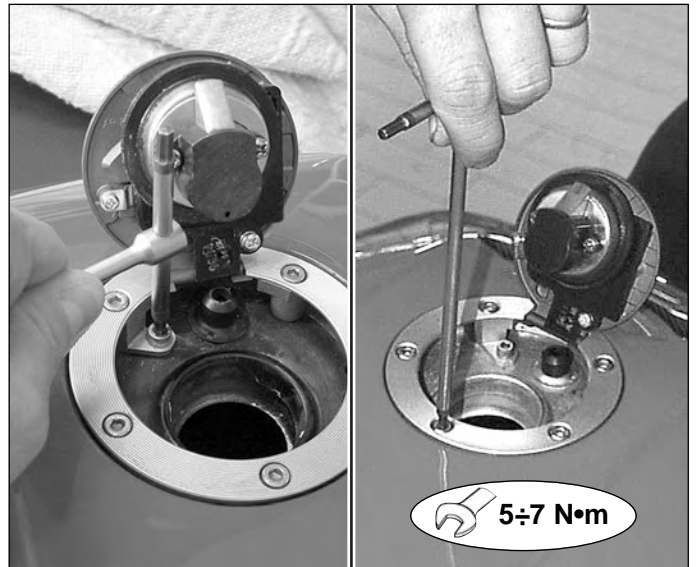

AIR FILTER COMPARTMENT

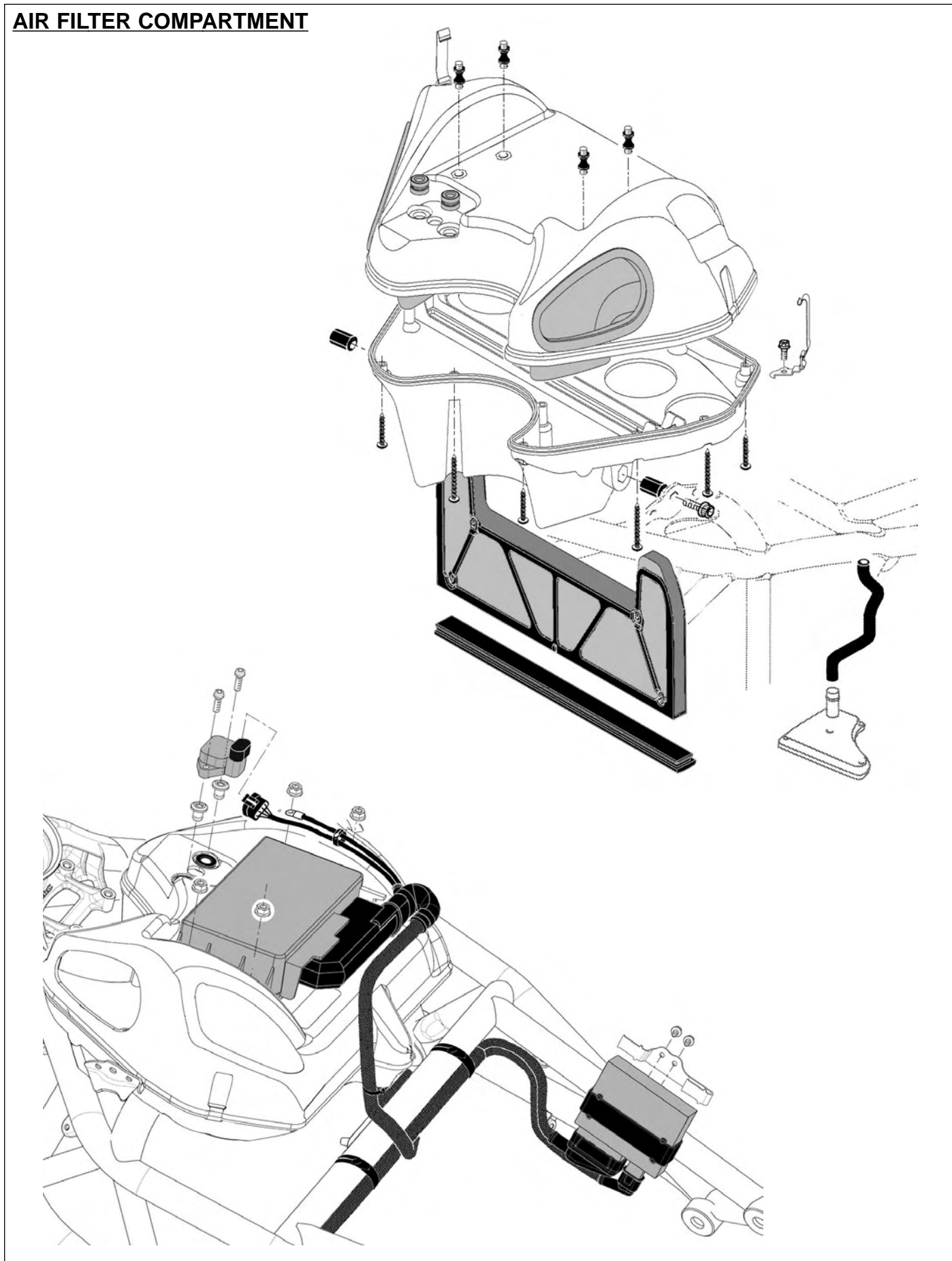

AIR FILTER COMPARTMENT REMOVAL

Before removing the air filter compartment you should primarily remove the fuel tank as described in the paragraph "Tank" of this chapter.

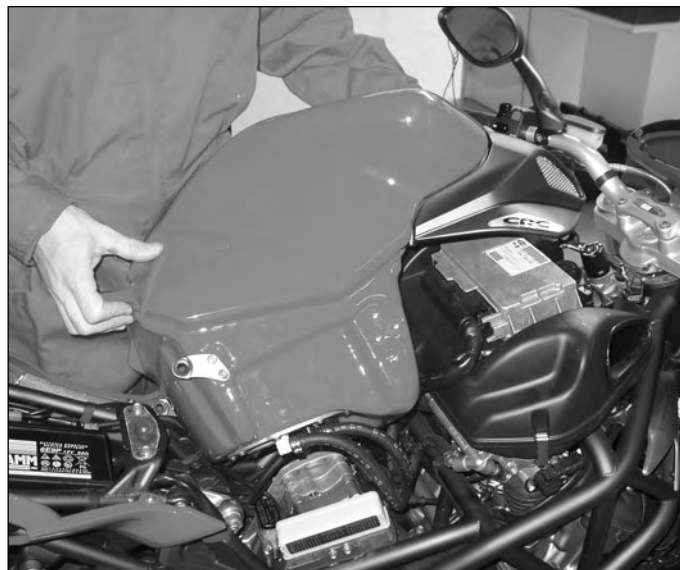

Unscrew and remove the fixing nut (1) of the earth wiring of the gearcase.

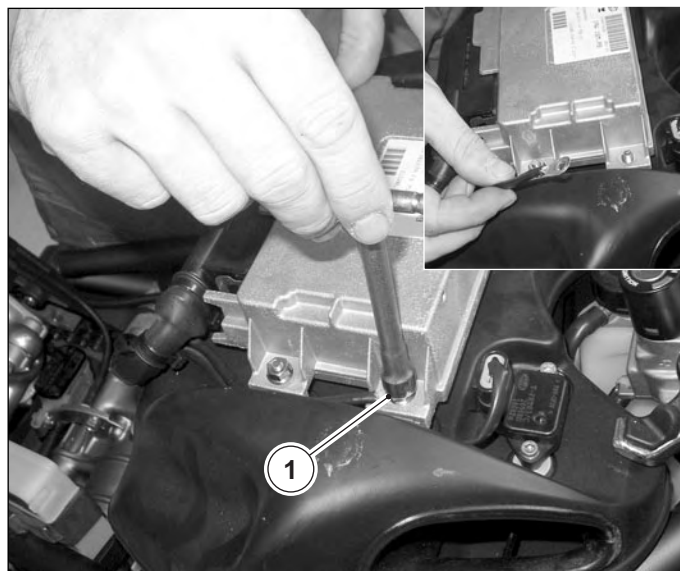

Disconnect the connector (1) of the temperature sensor and the air pressure from the sensor.

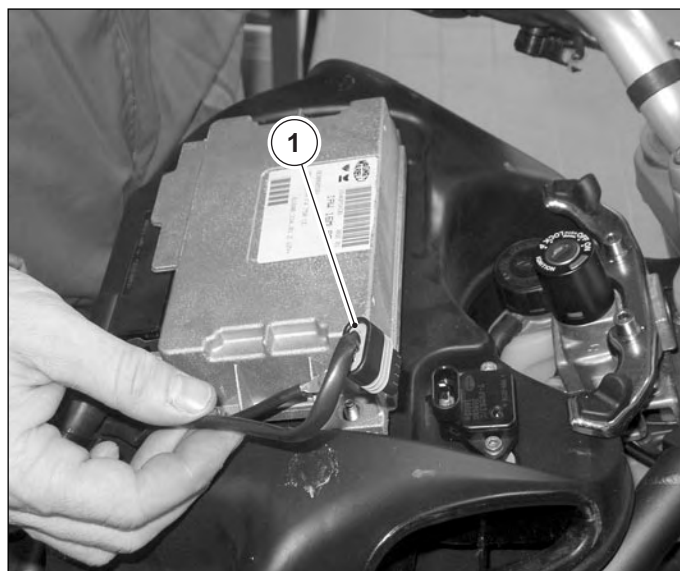



Bodywork

Disconnect the connection to the gearcase from the main wiring.



Release the fixing springs (1) of the air filter compartment box to the throttle body.

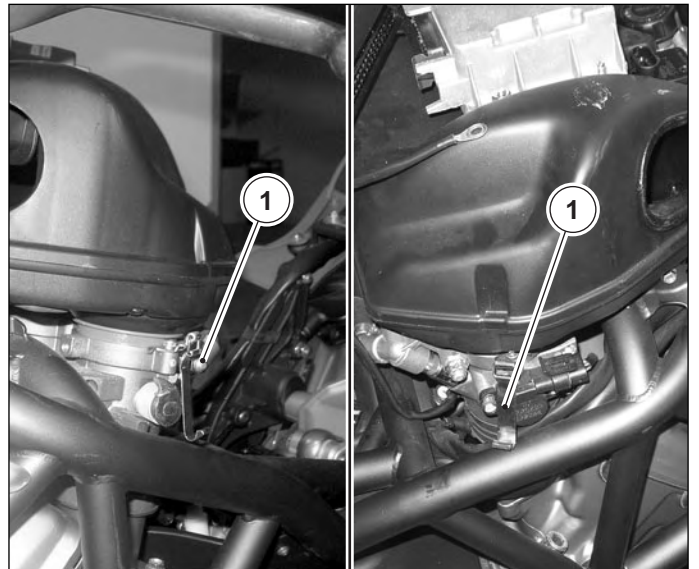

Unscrew and remove the two side fixing screws (1) of the air filter compartment to the frame.



Disconnect the breather piping (1) from the block.

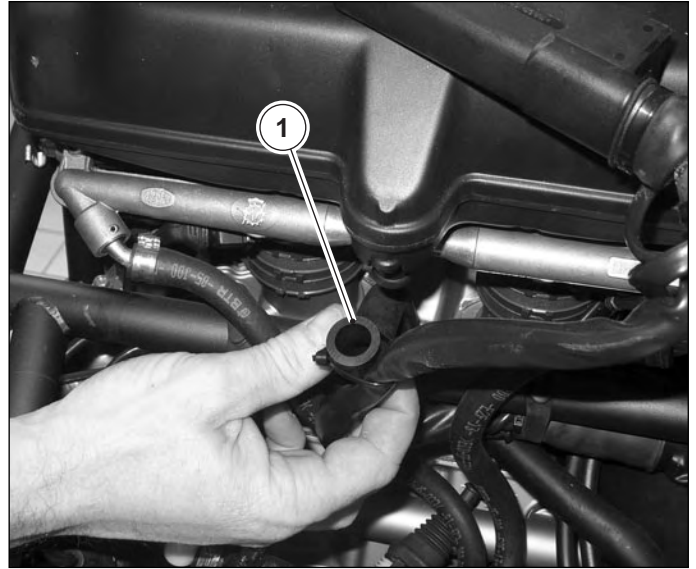

Unscrew and remove the two fixing screws (1) and the air filter compartment locking support (2).

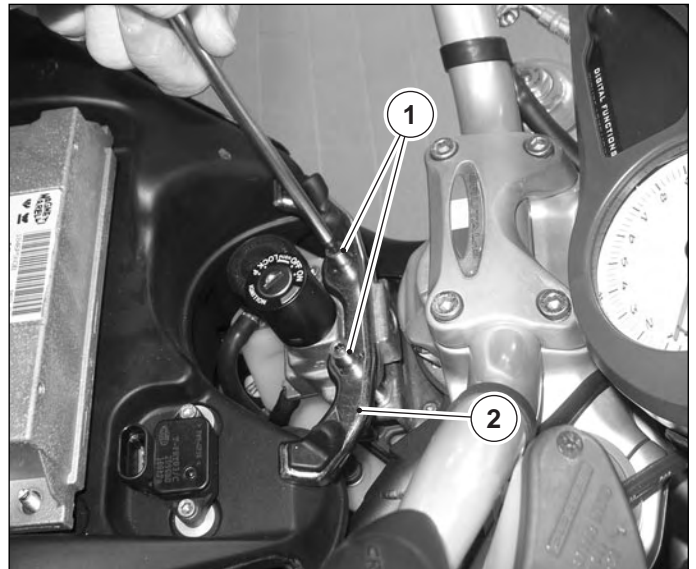

Remove the air filter compartment from the throttle body.

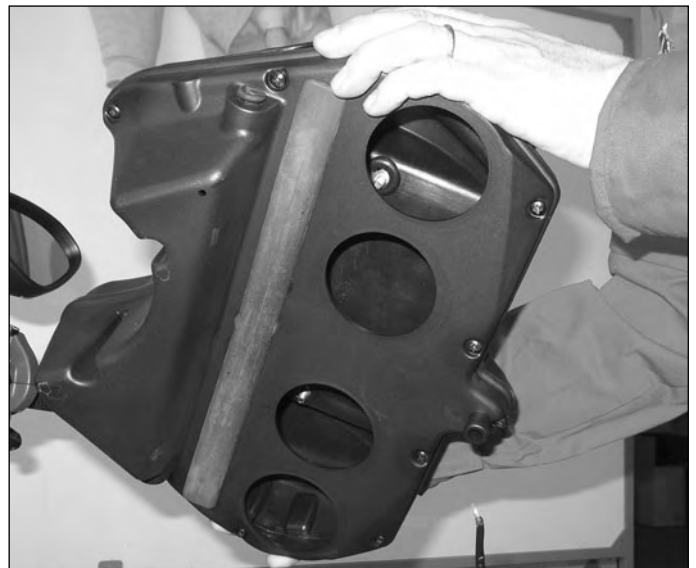



Bodywork

During the reassembling make the same operations of the disassembling paying attention to tighten the fixing screws (1) of the ignition commutator to the described torque wrench.

 **Torque wrench of the air filter compartment fixing screws and locking support: 8 ÷ 10 N•m**



Apply Loctite 243

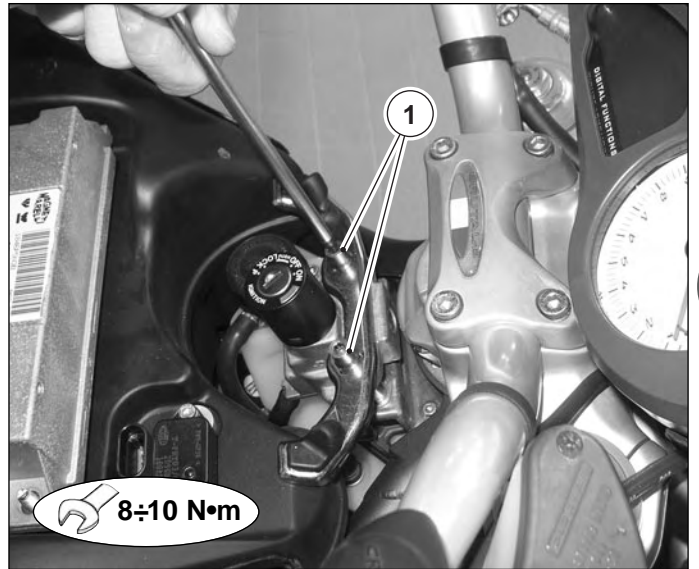

If you had to remove the fixing screws of the throttle body springs (1), during their reassembling apply the described brakethread and tighten them to the indicated torque.

 **Torque wrench of the fixing screws of the throttle body fly springs: 5 ÷ 7 N•m**



Apply Loctite 243

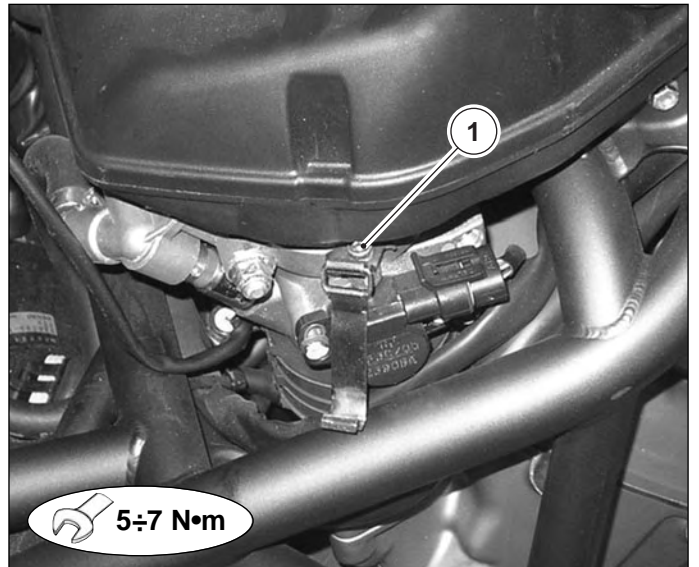

C

TAIL UNIT

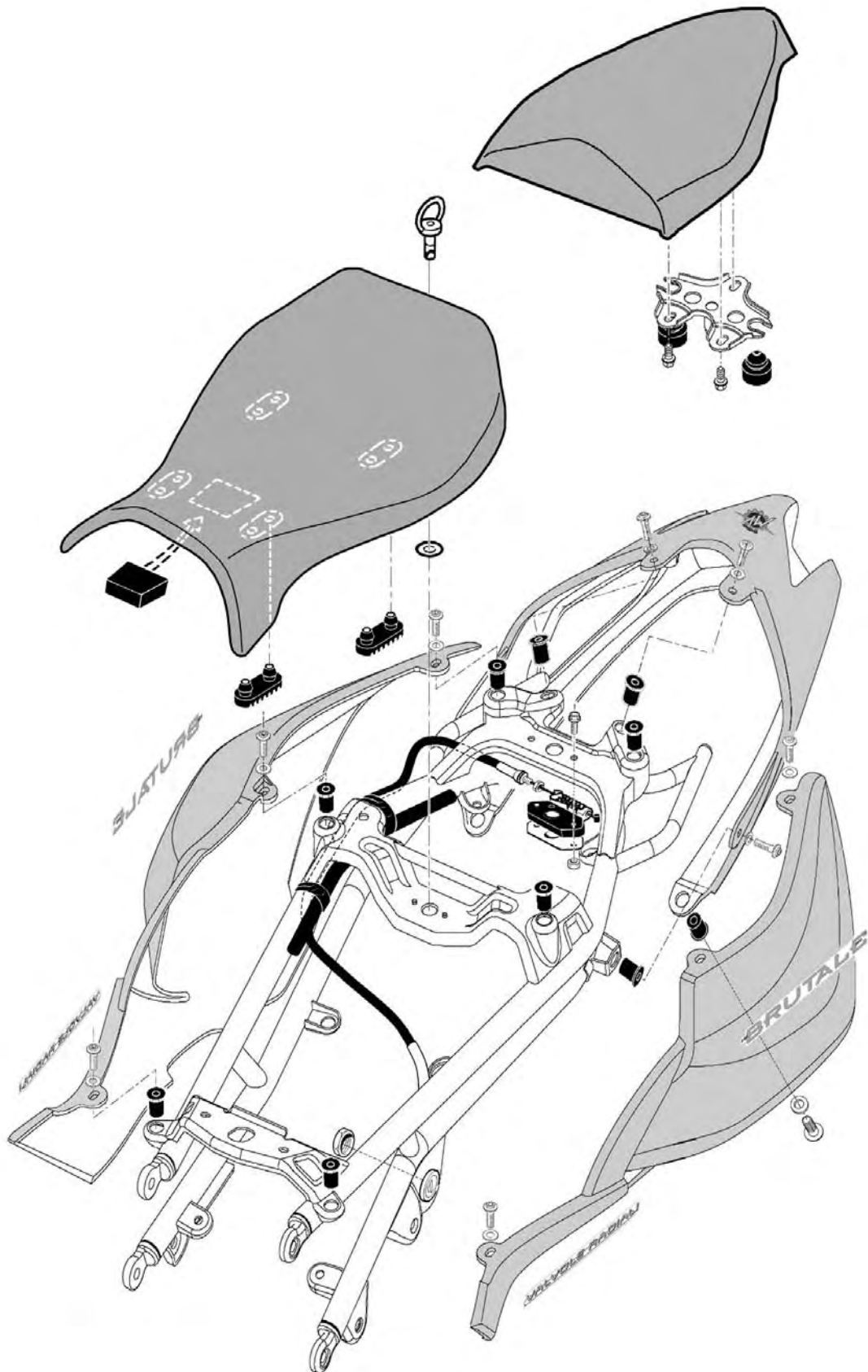



Bodywork

TAIL UNIT REMOVAL

Insert the ignition lock key in the opening seat lock on the left side of the motorcycle and rotate it clockwise. In the meantime push lightly on the passenger seat.

The lock will be released.



Remove the passenger seat.



Release the fixing clip of the rider seat and remove it from its seat by lifting it.





Bodywork

Unscrew and remove the three fixing screws (1) of the tale unit panels on both sides paying attention to recover the nylon washers (2).

C

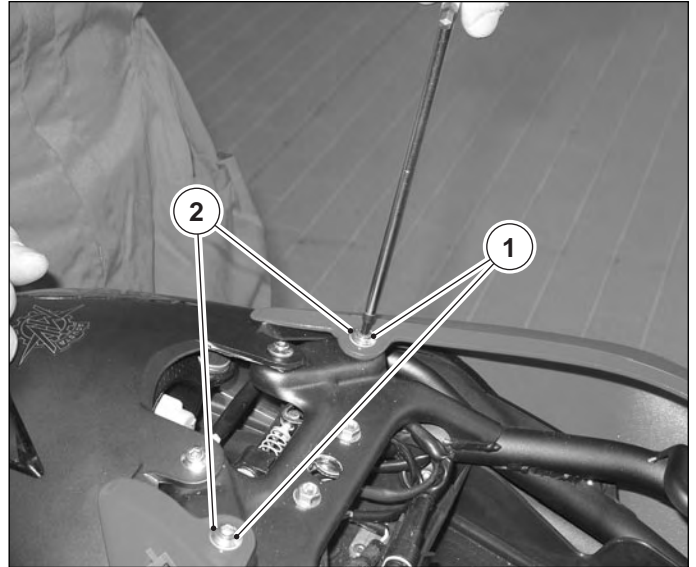

After that remove the side panels.

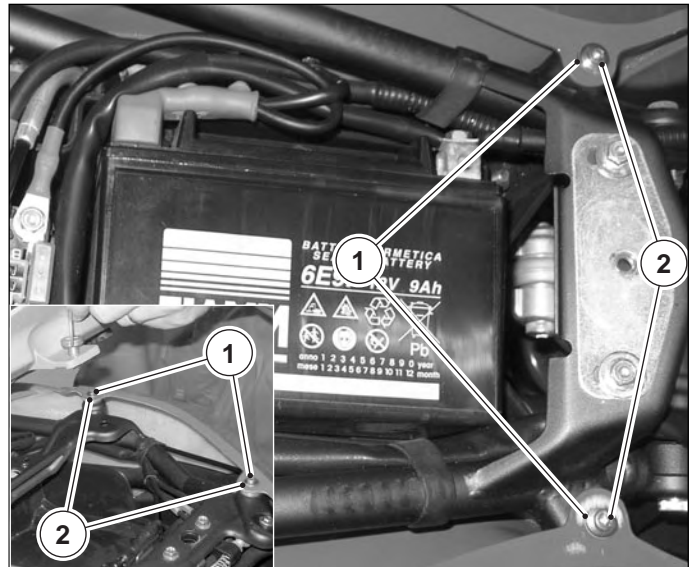

Extract the lamp holder of stop and side light from its seat.



Unscrew the four fixing screws of the rear part tale unit.



Remove the rear part of the tale unit.



Release the electric connector and remove the lamp holder of the tail and stop light with the wiring.



UNDER-TAIL ASSEMBLY

C

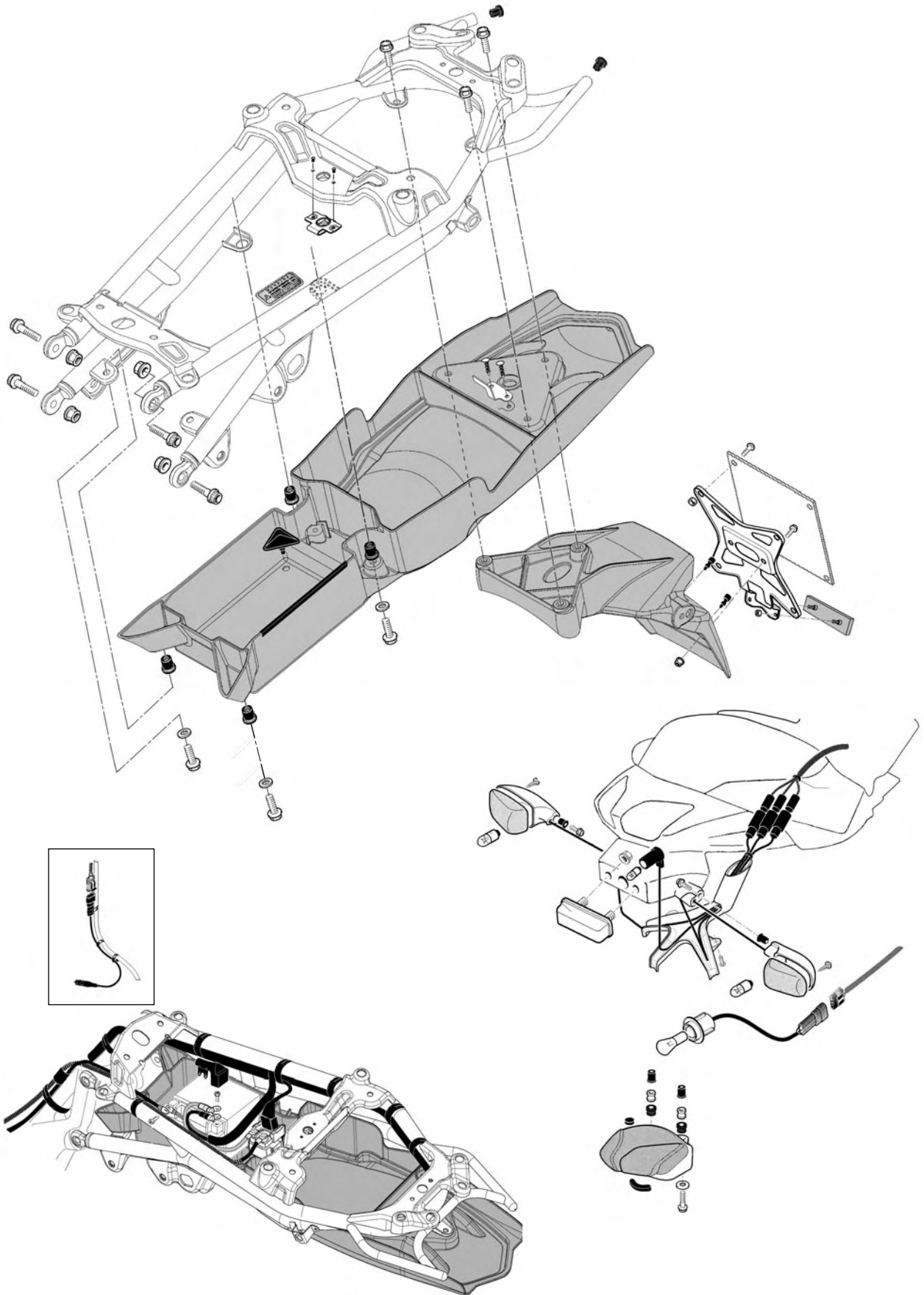

DISASSEMBLING UNDER TALE UNIT

Disassemble the passenger and rider seats and the side panels as described in the previous paragraph "Disassembling tale unit".

Disconnect the connections of the direction indicator and of the number plate light.



Unscrew the three fixing screws of the number plate holder.

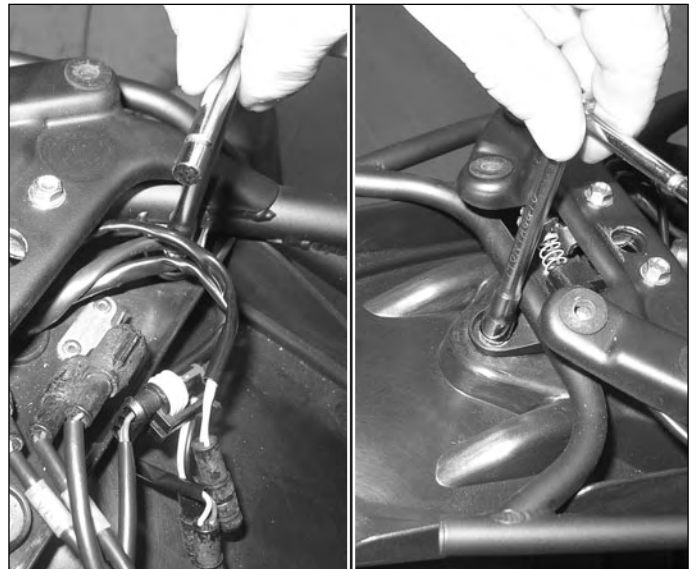

Remove completely the number plate holder.





Bodywork

Unscrew the fixing screws of the battery connections and remove it from its seat.



Release the connector from the solenoid starter.



Remove the fixing screw of the starter.





Bodywork

Unscrew the under tale unit fixing screws.

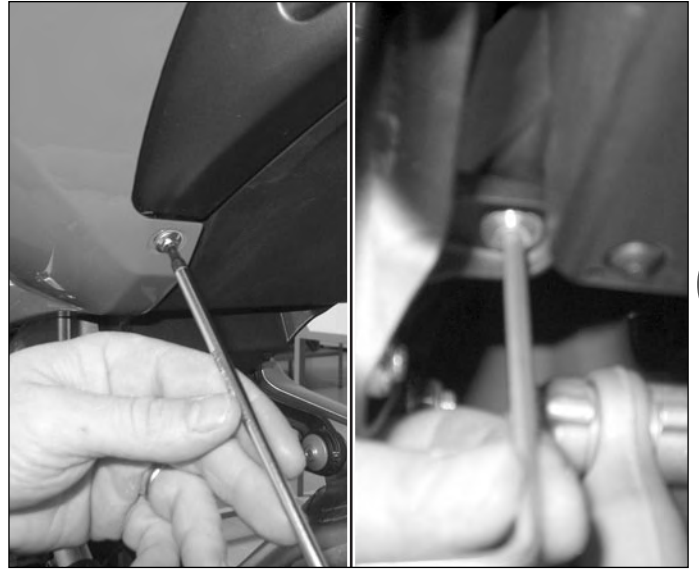

Remove the under tale unit.



C



Bodywork

C



Air intake injection system

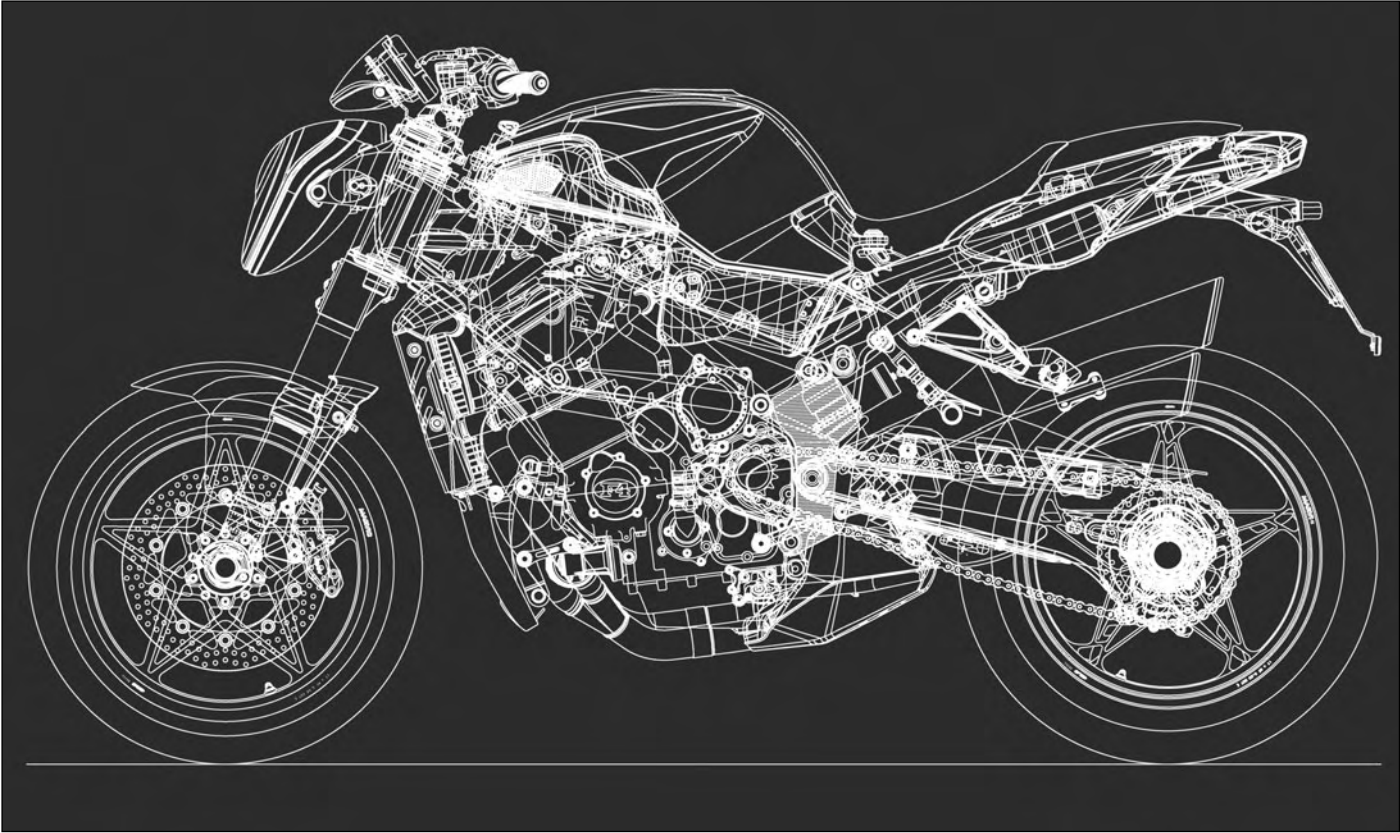

D

SECTION D

Revision 0



SUMMARY

INJECTION-IGNITION SYSTEM	PAGE 3
INJECTION SYSTEM TECHNICAL CHARACTERISTICS	PAGE 3
INJECTION TIME (INJECTION VOLUME).....	PAGE 3
INJECTION TIME COMPENSATION.....	PAGE 4
INJECTION ARREST CONTROL.....	PAGE 4
MOTOR CONTROL - POSITION OF THE PARTS.....	PAGE 6
FUEL PUMP CONTROL SYSTEM	PAGE 7
COMPONENTS	PAGE 9
SENSORS	PAGE 11
ENGINE PICK-UP	PAGE 14
TIMING WHEEL GAP	PAGE 14
ACTUATORS	PAGE 15
DIAGNOSTICS SYSTEM.....	PAGE 16
INJECTION SYSTEM - ELECTRICAL DIAGRAM	PAGE 17



Air intake injection system

INJECTION-IGNITION SYSTEM

The injection-ignition system is of the "alpha/N" type. The motor r.p.m. and the throttle position are used as main parameters to measure the amount of intake air to find the amount of fuel to be injected.

The amount of intake air for each cycle depends on the density of the air in the intake collector, the single displacement and the volumetric efficiency: this last is determined experimentally on the engine for the entire functioning range (rounds and engine load) and it is stored in the dimensioned plans (maps) inside the EPROM of the electronic CPU.

The motor r.p.m. and the throttle angle also allow to calculate the ignition advance best suited for any functioning condition.

The other system sensors (atmospheric pressure sensor, air temperature sensor, water temperature sensor and trimmer sensor) allow to adjust the basic strategy, in specific functioning conditions.

The injector control is of a semi-sequential type, that is to say, the four injectors are controlled in couples according to the intake sequence.

The ignition is of the static inductive charge type with control of coil charge time integrated into the power modules inside the CPU.

INJECTION SYSTEM TECHNICAL CHARACTERISTICS

INJECTION TIME (INJECTION VOLUME)

The factors for the determination of the injection time are the basic injection time that is calculated on the basis of the r.p.m. of the engine, the opening of the accelerator and various compensations that are determined according to signals coming from various sensors that reveal the condition of the engine and the riding conditions.

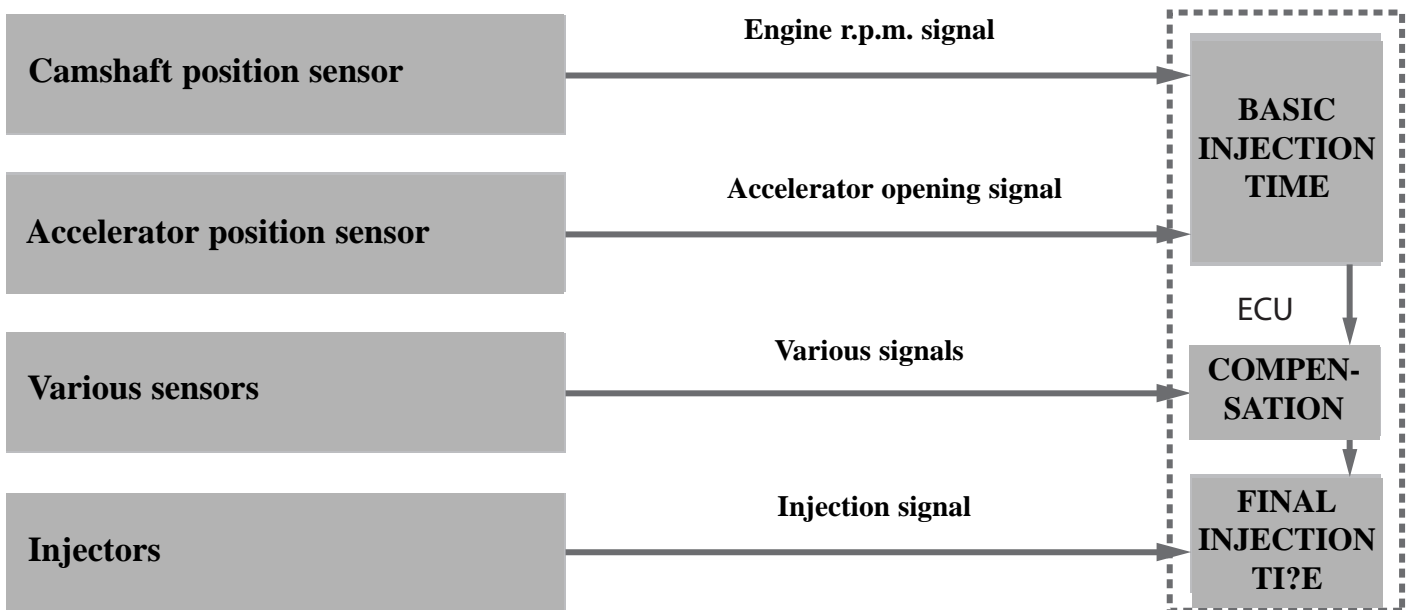



Air intake injection system

INJECTION TIME COMPENSATION

The various sensors allow the injection time (volume) compensations to be carried out on the basis of the following signals.

SIGNAL	DESCRIPTION
ATMOSPHERIC PRESSURE SENSOR SIGNAL	When the atmospheric pressure is low, the sensor sends a signal to the ECU to reduce the injection time (volume of the fuel injected) to compensate the lower presence of oxygen in the atmosphere.
ENGINE COOLANT TEMPERATURE SENSOR SIGNAL	When the temperature of the engine coolant is low, the injection time (volume) is increased to sustain the minimum r.p.m. and to compensate the part of the fuel which condensates along the intake conduits.
AIR INTAKE TEMPERATURE SENSOR SIGNAL	When the temperature of the intake air is low, the injection time (volume) is increased to compensate the higher presence of oxygen.
BATTERY VOLTAGE SIGNAL	The battery voltage signal is supplied to the ECU for the functioning of the ECU and this voltage is revealed and utilised as a signal for the compensation of the injection time (volume). A low voltage determines a longer injection time for adjustment of the volume of the injection.
STARTER SIGNAL	When the engine is switched on, during cranking a greater volume of fuel is injected to make starting easier.
ACCELERATION/DECELERATION SIGNAL	During acceleration, the injection time of the fuel (volume) is increased in proportion to the opening of the accelerator and the r.p.m. of the engine. During deceleration, the injection of fuel is diminished in proportion to the speed of closure of the accelerator handgrip and of the engine r.p.m.

INJECTION ARREST CONTROL

SIGNAL	DESCRIPTION
R.P.M. LIMITER SIGNAL	The functioning of the fuel injectors is interrupted when the level of engine r.p.m. reaches its limit.



Air intake injection system

IGNITION SYSTEM

DESCRIPTION

The system belongs to the family of integrated systems of digital electronic ignition with advance static timing and electronic fuel injection of the semi-phased intermittent type (injected and ignition simultaneously to cylinders 1-4 and 2-3).

This ignition system consists of an engine crankshaft position sensor (pick-up), an ECU, four ignition coils of the top plug type and four spark plugs.

The feed of the ignition coil is supplied by the battery via the power relay and is controlled by the ECU with regards to the position of the switches of the side stand and the gearchange.

The ignition timing is precisely controlled with regards to the engine r.p.m. and the position of the accelerator. Other than this basic condition, also the temperature, intake air pressure and the temperature of the engine coolant influence the ignition timing.

N.B.

The ignition interruption circuit is incorporated in the ECU to avoid over-revving the engine. If the motor reaches 12100 r.p.m., this circuit prevents the ignition for all cylinders.

WARNING

The engine could function at more than 12100 r.p.m. without a load or when changing down, even if the interruption circuit functions and therefore could damage the engine. Never spin the engine at more than 12100 r.p.m. in any conditions.

D

D

MOTOR CONTROL - POSITION OF THE PARTS

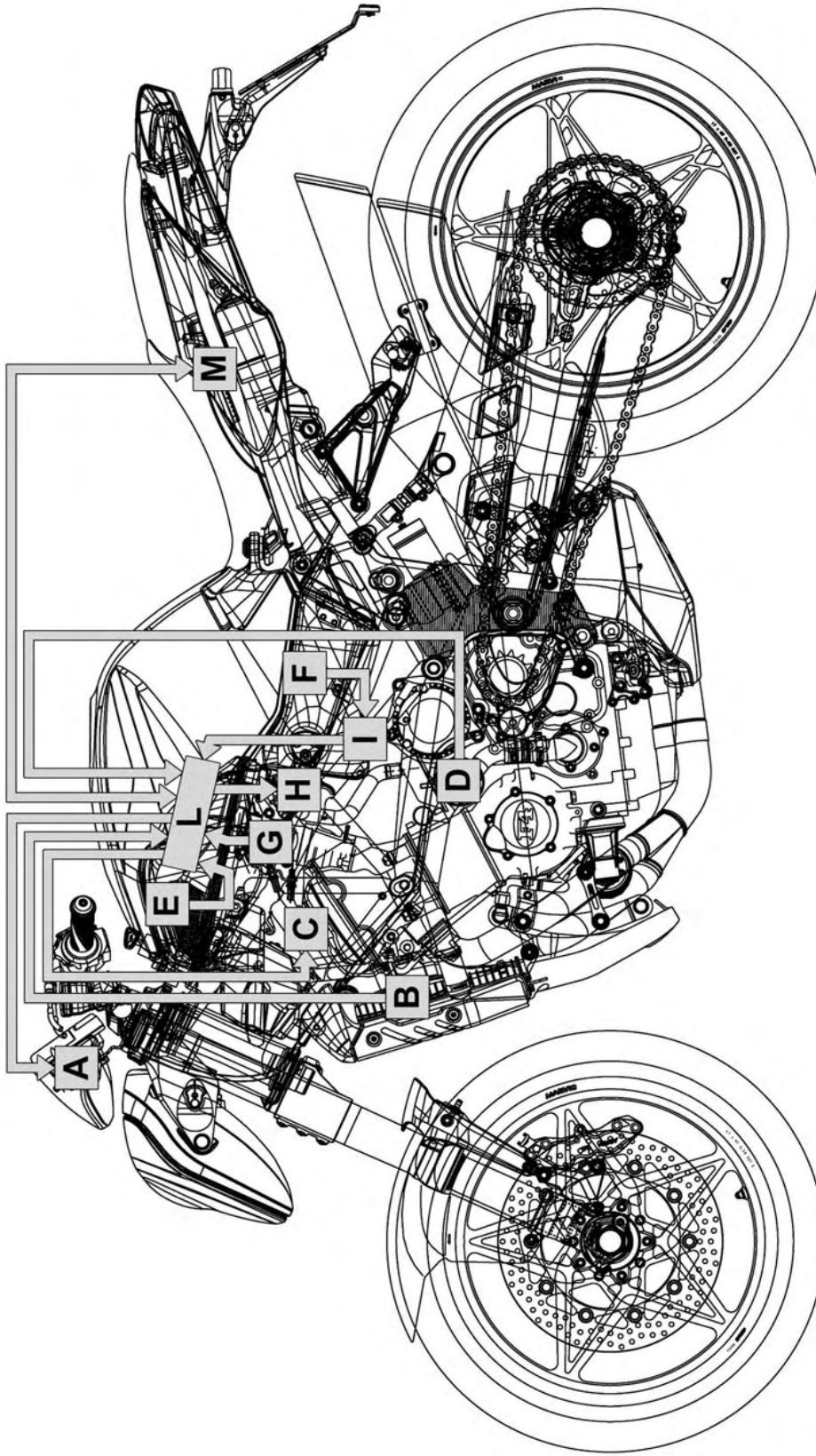

- | | | | | | |
|----------|-----------------------------------|----------|--|----------|--------------------|
| A | Instrument panel | E | Intake air pressure/temperature sensor | I | Service unit |
| B | Engine coolant temperature sensor | F | Fuel pump | L | Motor control unit |
| C | Ignition coil | G | Accelerator position sensor | M | Starter switch |
| D | Camshaft position sensor | H | Fuel injectors | | |



Air intake injection system

FUEL PUMP CONTROL SYSTEM

When the ignition switch is switched to the "ON" position, the current from the battery reaches the motor of the fuel pump via the side stand relay and the pump relay thereby switching on the motor. As the CPU possesses a timer function, the pump motor stops turning three seconds after the ignition switch has been brought to the "ON" position. If the starter motor turns the electric motor shaft during or after the three seconds, the motor rotation signal is sent to the CPU that, by controlling the pump relay, makes the pump motor function continuously. When the ignition switch is switched to the "OFF" position, the control of the pump relay is interrupted and contemporaneously also the control of the injectors and the ignition coils, thereby causing the engine to switch off.

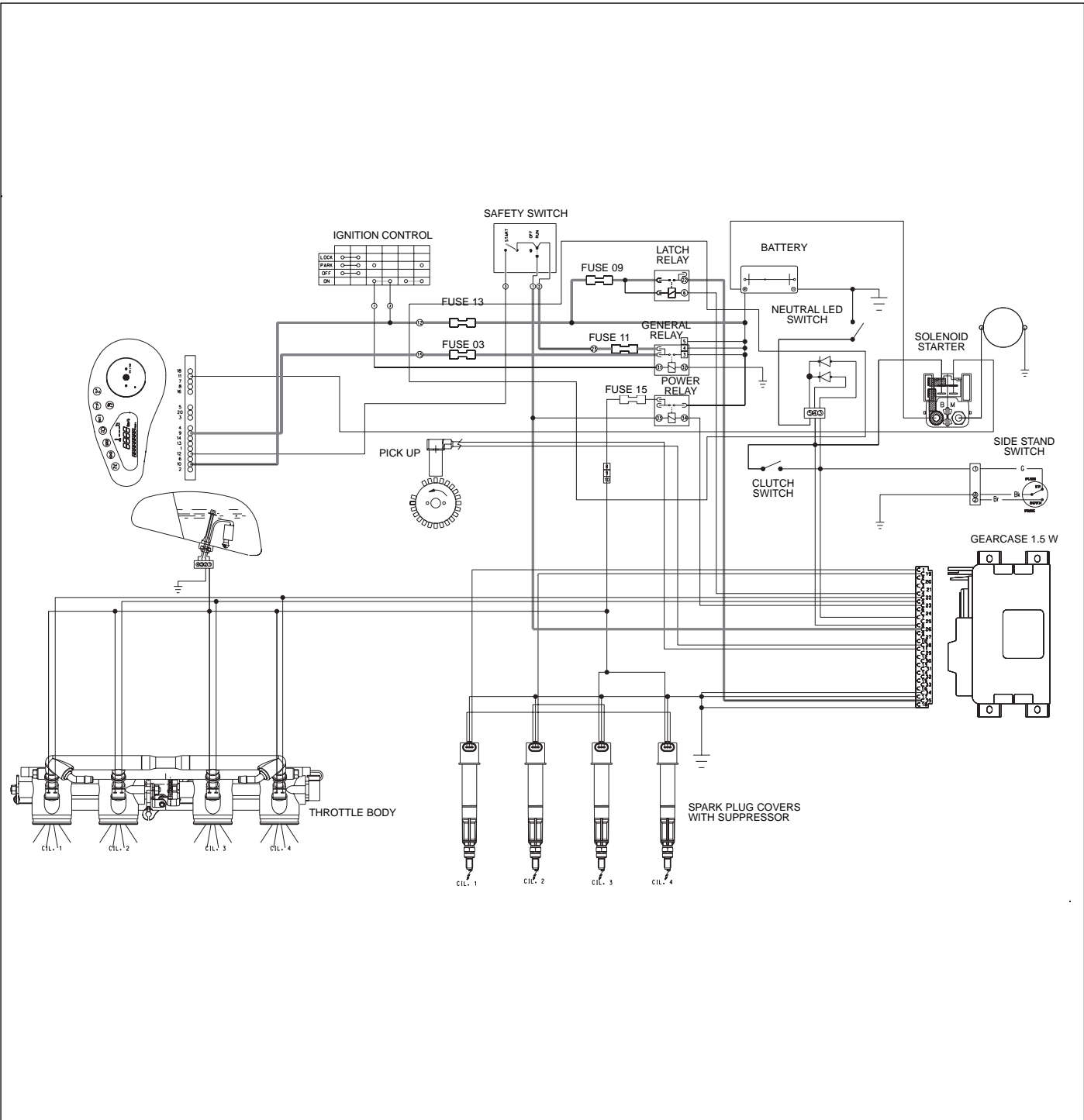



Air intake injection system

Fuel feed system

The fuel feed system consists of the tank, pump, filter, feed tube, feed tubes (including the fuel injectors), regulator of the pressure and the fuel return tube. The fuel in the tank is pumped into the feed tubing at a controlled pressure by the relative regulator and maintained at a certain constant value higher than the suction generated by the motor. The fuel is injected into the air intake conduit when the injector opens, following a law generated by the ECU. The excess fuel is not consumed and returns to the tank via return fuel tube.

D

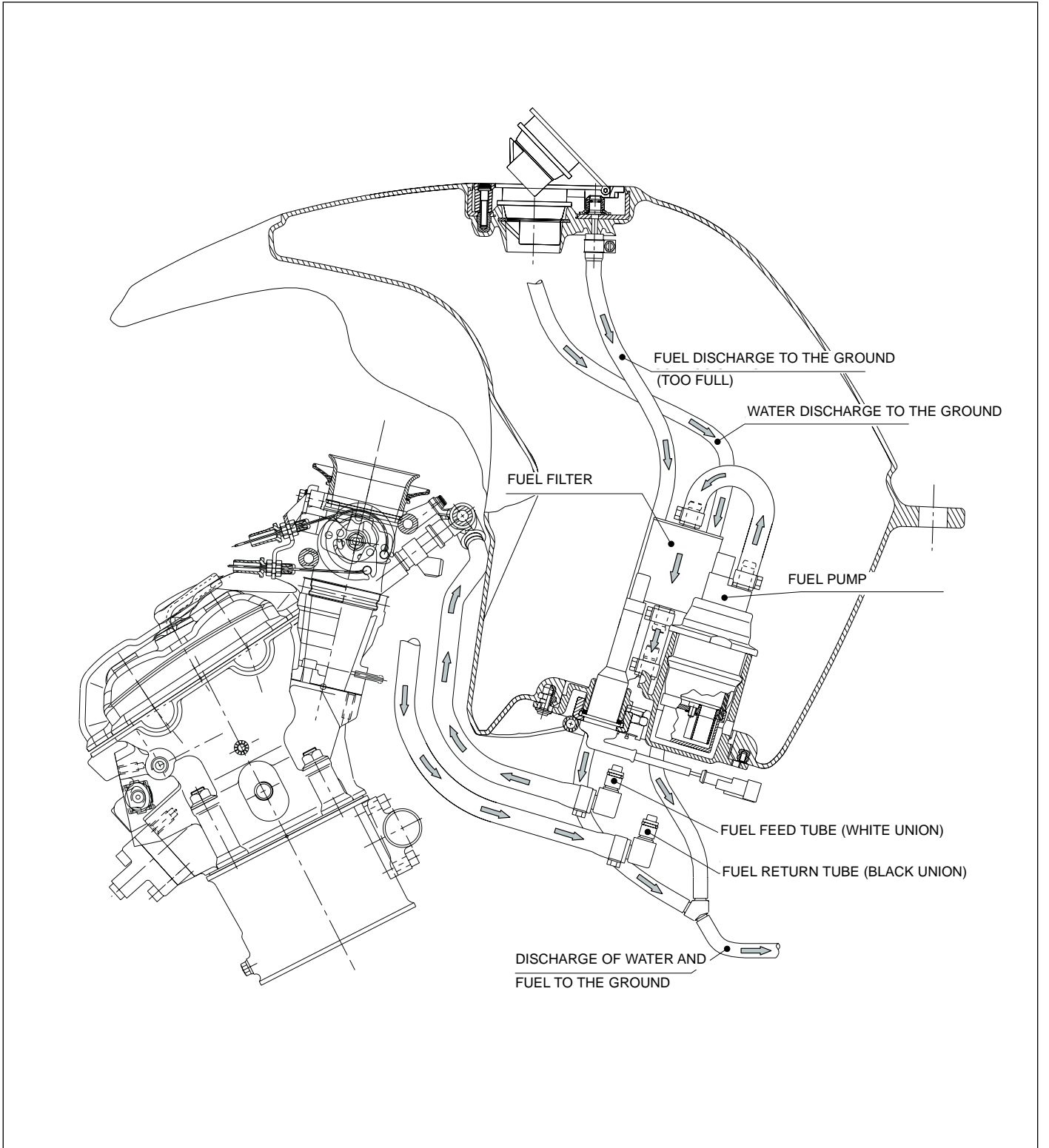



Air intake injection system

COMPONENTS

Fuel pump

The electric fuel pump that is situated inside the fuel tank consists of an electric motor, of the rotor, impeller, control valve and pressure release valve.

The ECU controls the ON/OFF condition as described in the section FUEL PUMP CONTROL SYSTEM.

When electrical energy is supplied to the pump, the motor switches on and the impeller activates. This causes a difference in pressure on both sides of the impeller because the paddles of the impeller are grooved. The fuel is therefore sucked towards the output passage. The pump possesses a control valve to maintain a certain pressure in the fuel feed tube even when the pump is stopped and the pressure release valve opens to send fuel back to the tank when the pressure of the feed fuel increases to 4.5 - 6.5 kg/cm².

Absorbed current: 6 – 6.5A at a 13.5V voltage input

D

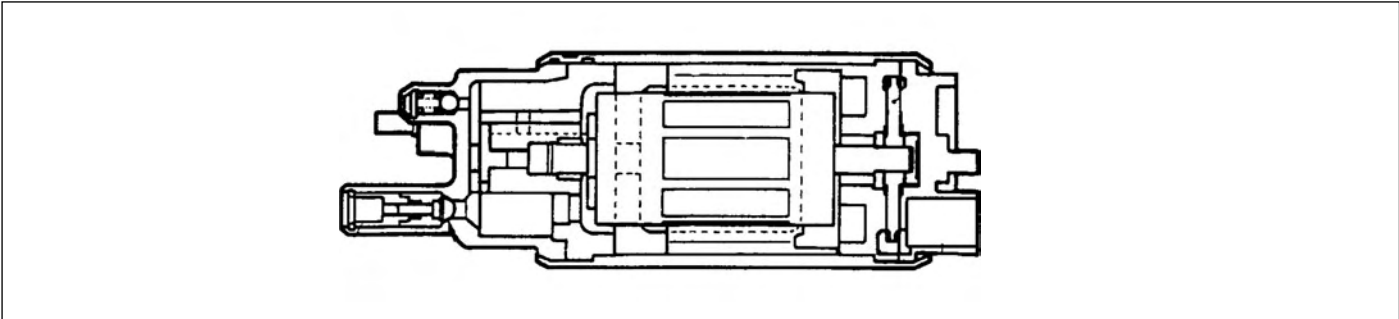

When the motor activates the impeller there is a difference in the pressure between the front part of the paddles and the rear part with the grooves, seen from an angular direction, because of the friction of the fluid. This process is continuous, thereby causing the increase in the fuel pressure. The pressurised fuel therefore leaves the pump chamber and is discharged towards the section of the motor and the control valve.

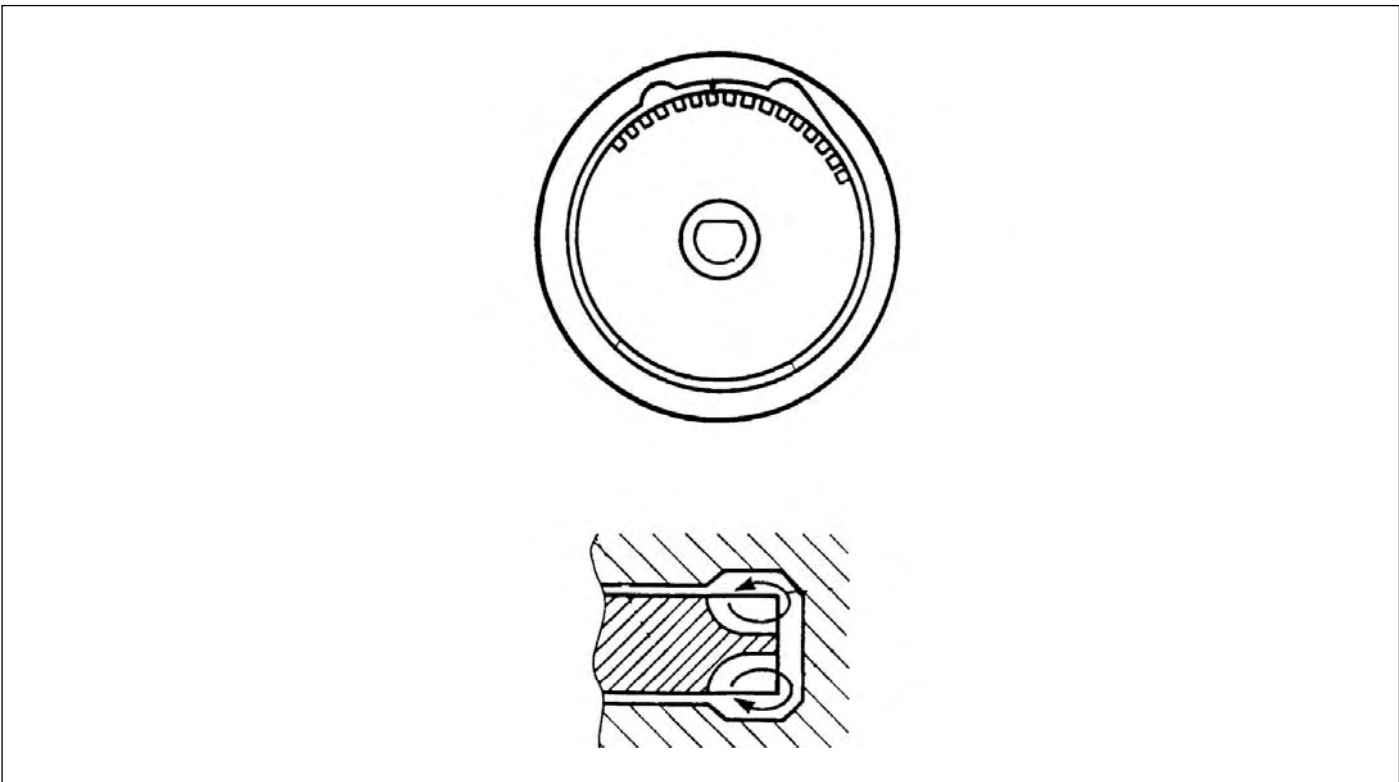



Air intake injection system

Fuel pressure regulator

The fuel pressure regulator is a diaphragm pressure release valve that consists of a diaphragm, spring and valve. It always maintains the pressure of the fuel sent to the injector at 3.0 kg/cm² (300 kPa).

When the pressure of the fuel rises above 3.0 kg/cm² (300 kPa) the excess fuel opens the valve of the regulator and therefore can return to the fuel tank.

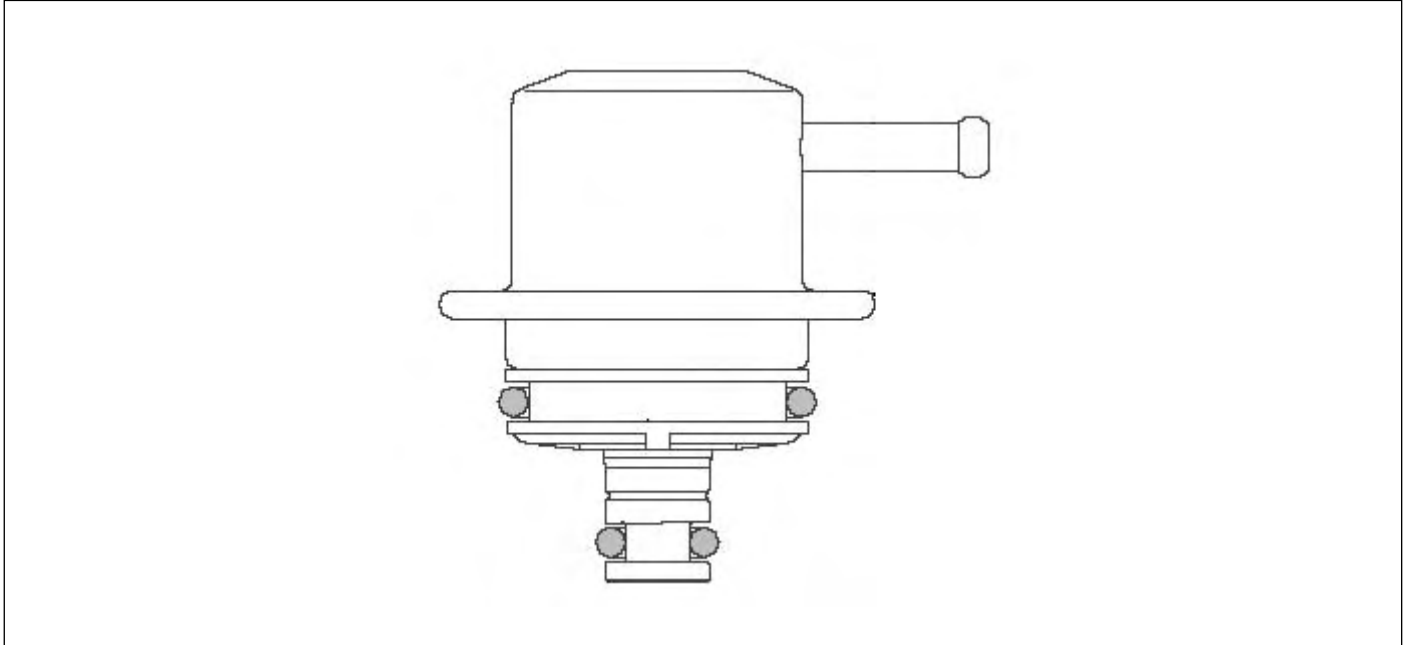



Air intake injection system

SENSORS

Atmospheric air temperature/pressure

The air intake sensor is situated on the right side of the air filter compartment and indicates both the atmospheric pressure and the air temperature.

Intake air pressure sensor

The sensor reveals the pressure of the intake air and this pressure is therefore converted into voltage that is sent to the ECU.

The basic injection time (volume) of the fuel is determined according to the voltage of the signal (output voltage).

The voltage increases when the pressure of the intake air is high.



D

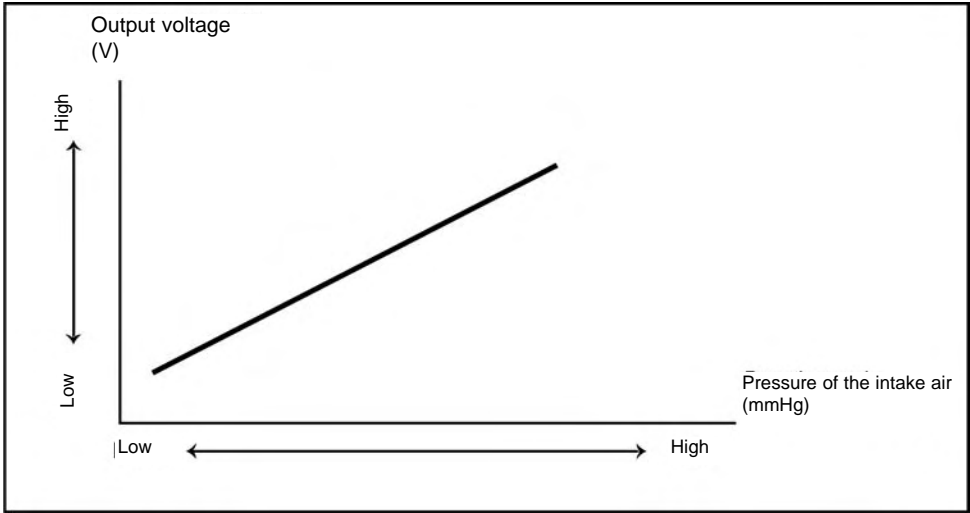



Air intake injection system

Intake air temperature sensor

The temperature of the intake air is found measuring the resistance of the Thermistor. The resistance value read is proportionate to the voltage read by the ECU.

The volume of fuel injected increases when the intake air temperature is low.

The resistance of the Thermistor increases when the air temperature is low and diminishes when the temperature is high (NTC type sensor).

D

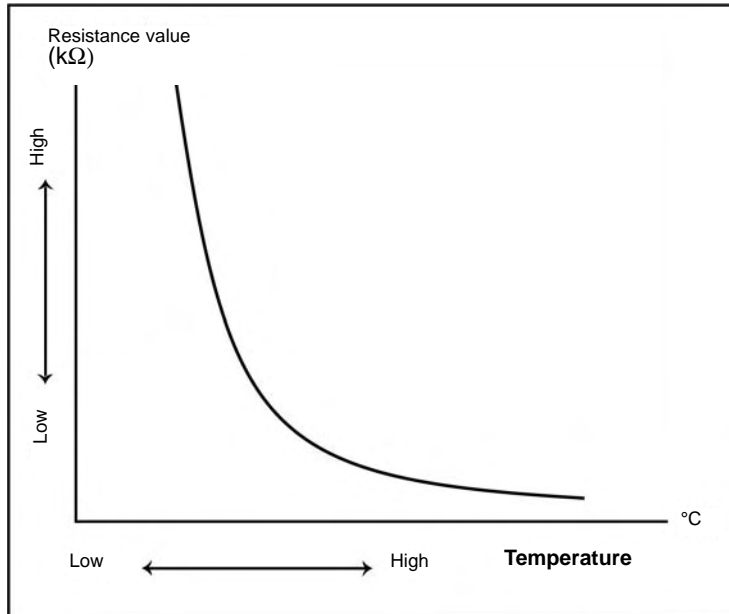

AIR TEMPERATURE → D - C

Air temperature sensor characteristics	
Temperature (°C)	Resistance (kΩ)
-10	9.5
0	6
10	3.8
20	2.5
30	1.6
40	1.1
60	0.6

AIR PRESSURE → D - A

VOLTAGE FEED TEST

→ D - B (~ 4,9 ± 0,1 volt)

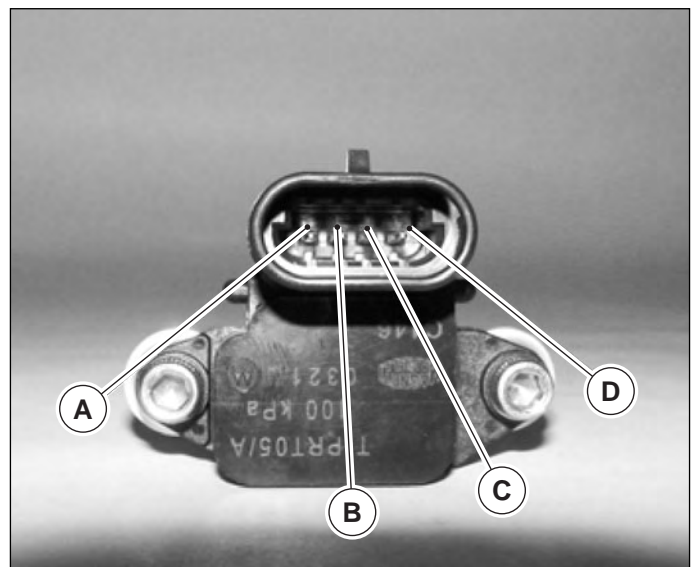



Air intake injection system

Throttle body position

The sensor of the throttle position is situated on the right side of the throttle body. This sensor is a potentiometer with a resistance which varies according to the opening angle of the accelerator. The sensor is supplied by the ECU at a stabilised voltage of 5V and supplies an output voltage proportionate to the throttle angle. The basic injection time of the fuel (volume) is determined according to the output voltage of this sensor. The voltage increases when the accelerator opening is increased.



D

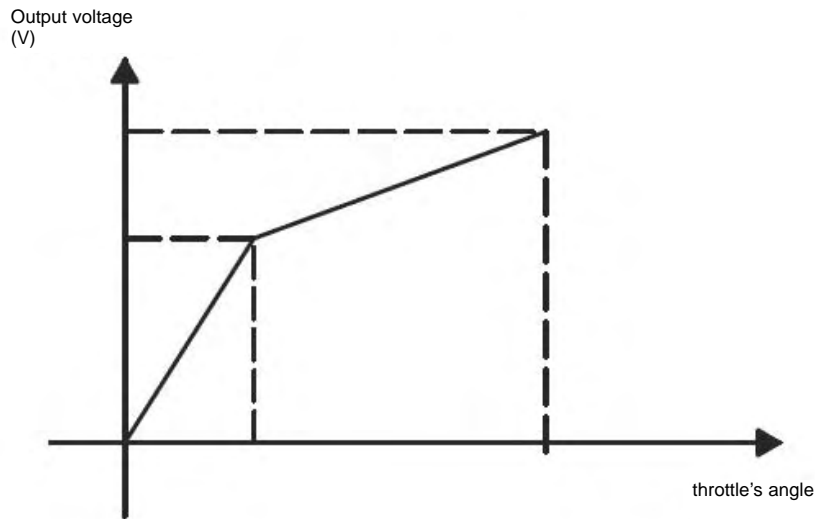

RESISTANCE TEST → A - C

FEED TEST → (~ 4,9 ± 1 volt)

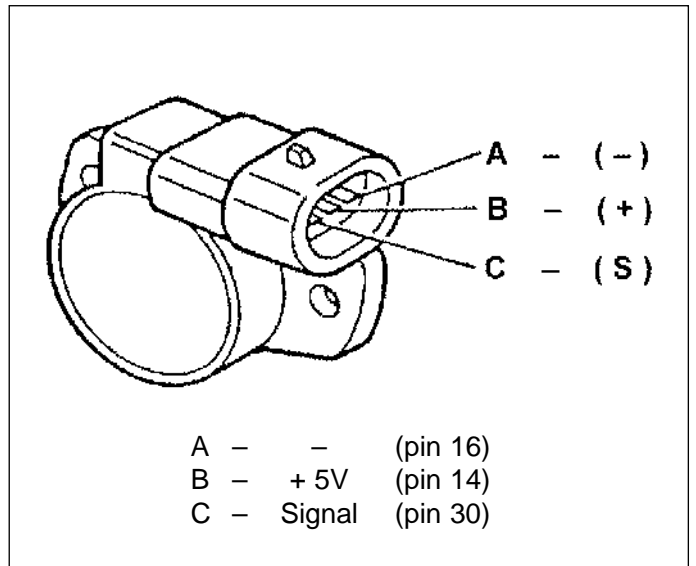



Air intake injection system

ENGINE PICK-UP

The r.p.m./TDC sensor is of an inductive type and is situated on the left side of the motorcycle.

To check this component it is necessary to identify the relative connector positioned as shown in the figure, inside the frame on the right side of the motorcycle.



After having disconnected the pick-up connector, measure the resistance between the two points identified by (+) and a (-) that are indicated on the connector.

Pick-up resistance value: $\sim 680 \div 700\Omega$

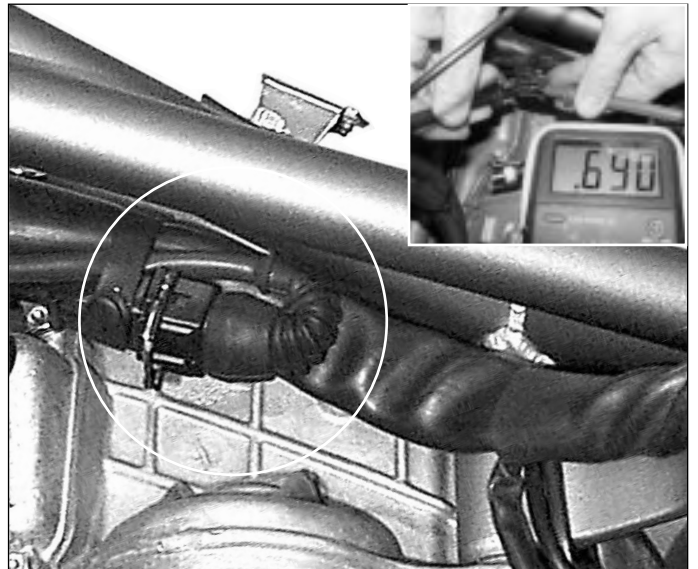

TIMING WHEEL GAP

To guarantee the correct functioning of the pick-up it is necessary to measure the gap between the pick-up and the timing wheel, that is to say the distance between the pick-up and the timing wheel by utilising a feeler gauge as shown in the figure.

GAP width: $0,6 \div 0,7$ mm

To carry out this check it is necessary to remove the cover of the timing wheel by consulting the Workshop Engine Manual.

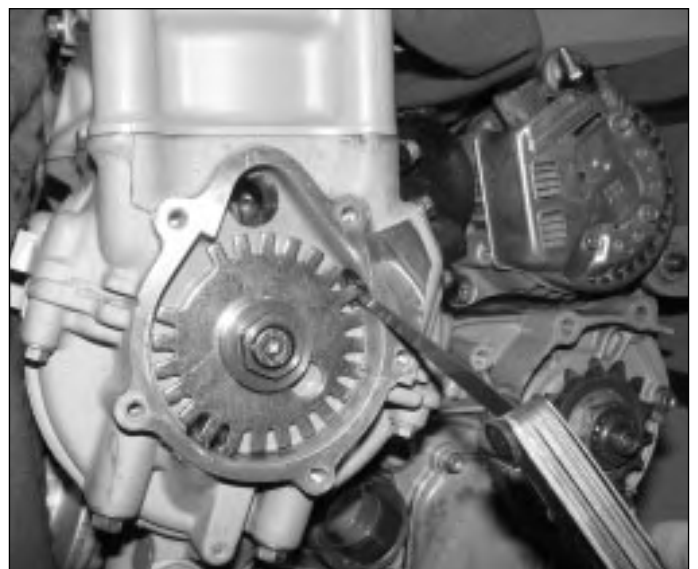



Air intake injection system

ACTUATORS

Fuel injector

The fuel injector consists of a solenoid, piston, needle valve and a filter. The injector is a small electromagnetic injection nozzle that injects fuel into the carburettor according to the signal coming from the ECU. When the solenoid is agitated by the ECU, it becomes an electromagnet and attracts the piston. At the same time, the needle valve incorporated in the piston opens and the injector, under pressure of the fuel, injects the fuel in a conical dispersion. Given that the opening of the needle valve is constant, the volume of fuel injected at any one time is dependent on the time that the solenoid is agitated (injection time).

TECHNICAL DATA: Winding resistance 14.5 Ω

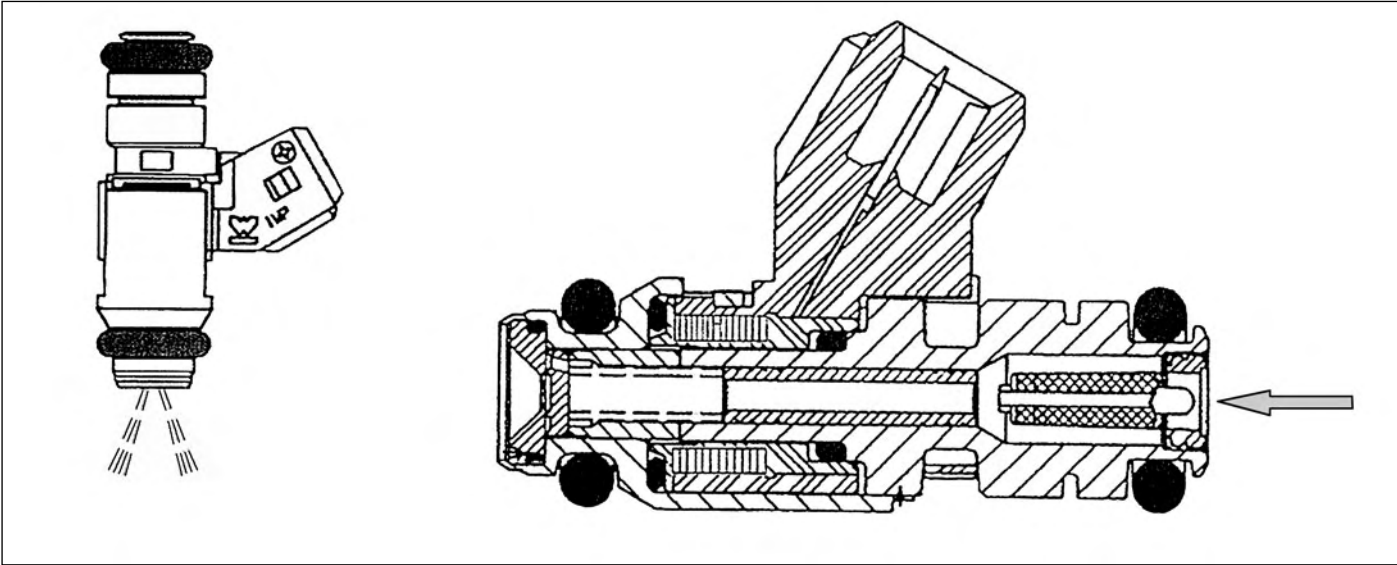

Ignition coils

The ignition coils are of the top plug type (they are assembled directly on the spark plugs. This avoids the use of the HT leads and enhance the overall system reliability.

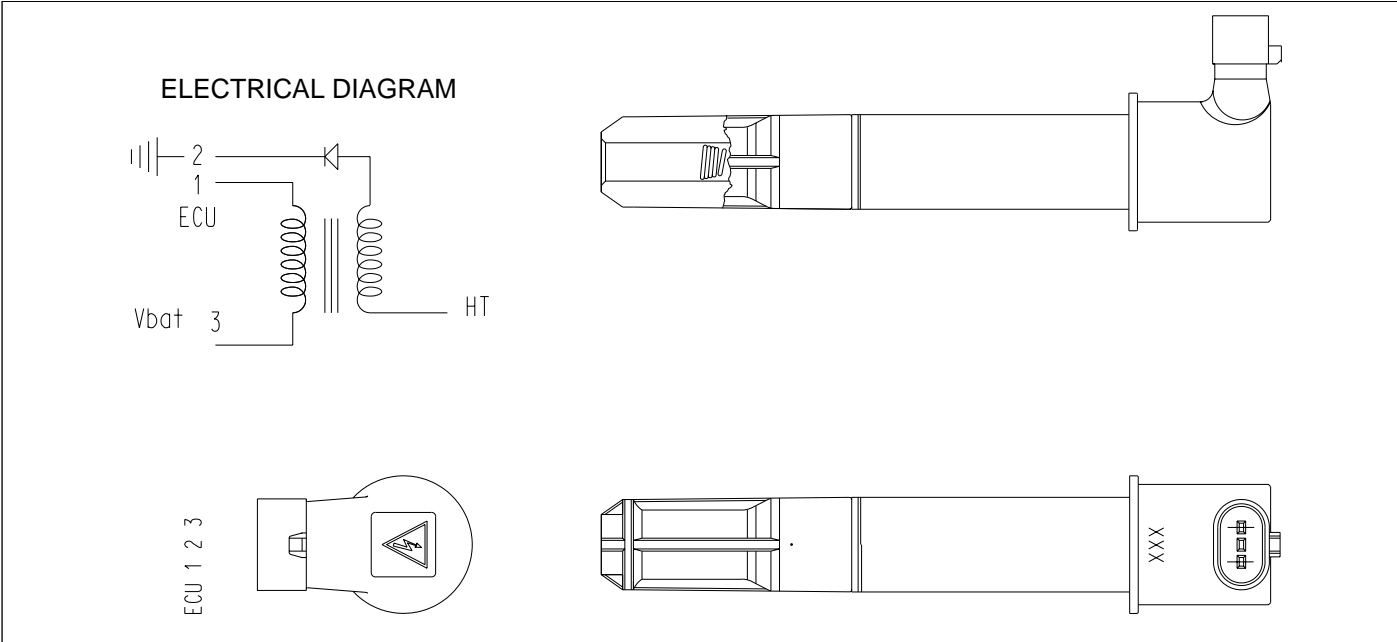



Air intake injection system

DIAGNOSTICS SYSTEM

Ignition and injection system diagnostics

For the diagnosis of the ignition and injection system A Weber-Marelli diagnostic software is available which is capable of identifying and recording the faults present or that were present previously on the motorcycle. This software is equipped with a guide book for the use of the software itself to carry out checks on each individual component of the system.

D



the MDST software allows to carry out the following operations:

- reading of engine parameters
- reading of faults and their deletion
- active diagnosis





Air intake injection system

INJECTION SYSTEM - ELECTRICAL DIAGRAM

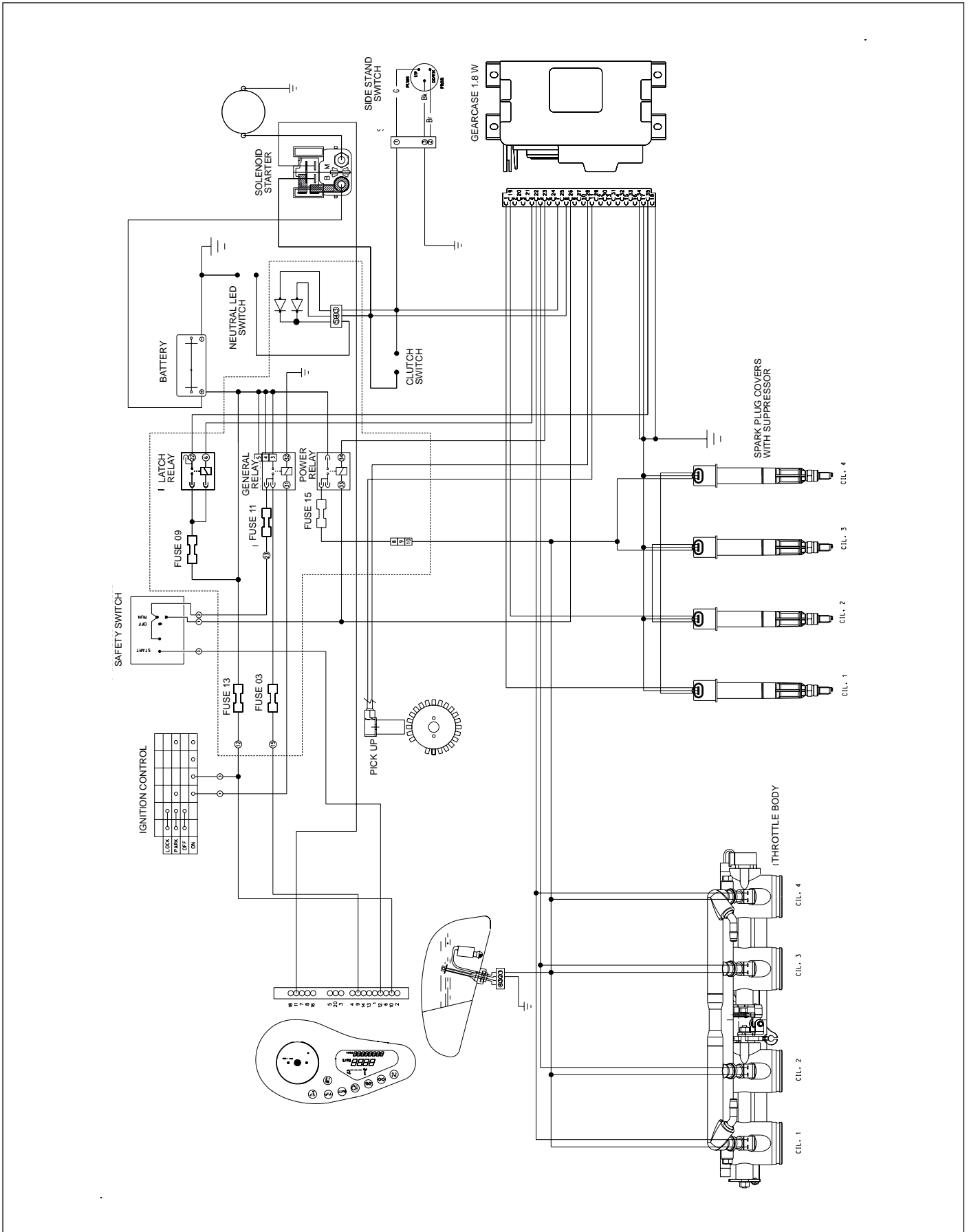

D



Air intake injection system

MV Agusta Brutale Oro – S Engine control unit pinout

Pin	Description	Type of signal
01	cylinders 1-4 coil control	power output
02	nc	
03	nc	
04	Latch relay control	digital output
05	Injectors 2-3 control	power output
06	nc	
07	engine enabling from safety logics	digital input
08	aknowledgment of gear not engaged	digital input
09	nc	
10	K rx line	communication line
11	r.p.m./tdc sensor (pick up)	frequency input
12	nc	
13	water temperatue sensor signal	analogue input
14	sensor reference voltage	power output
15	K tx line	comunication line
16	sensor gnd	power output
17	power gnd	power input
18	nc	
19	cylinders 2-3 coil control	power output
20	fan control	
21	nc	
22	injectors 1-4 control	power output
23	power relay control (fuel pump of coil injectors)	digital output
24	revcounter control	frequency output
25	nc	
26	on key input	digital input
27	nc	
28	r.p.m./tdc sensor (pick up)	frequency input
29	nc	
30	throttle potentiometer signal	analogue input
31	air temperature sensor signal	analogue input
32	air pressure signal	analogue input
33	nc	
34	power gnd	power input
35	enabling from latch relay	



Electrical system

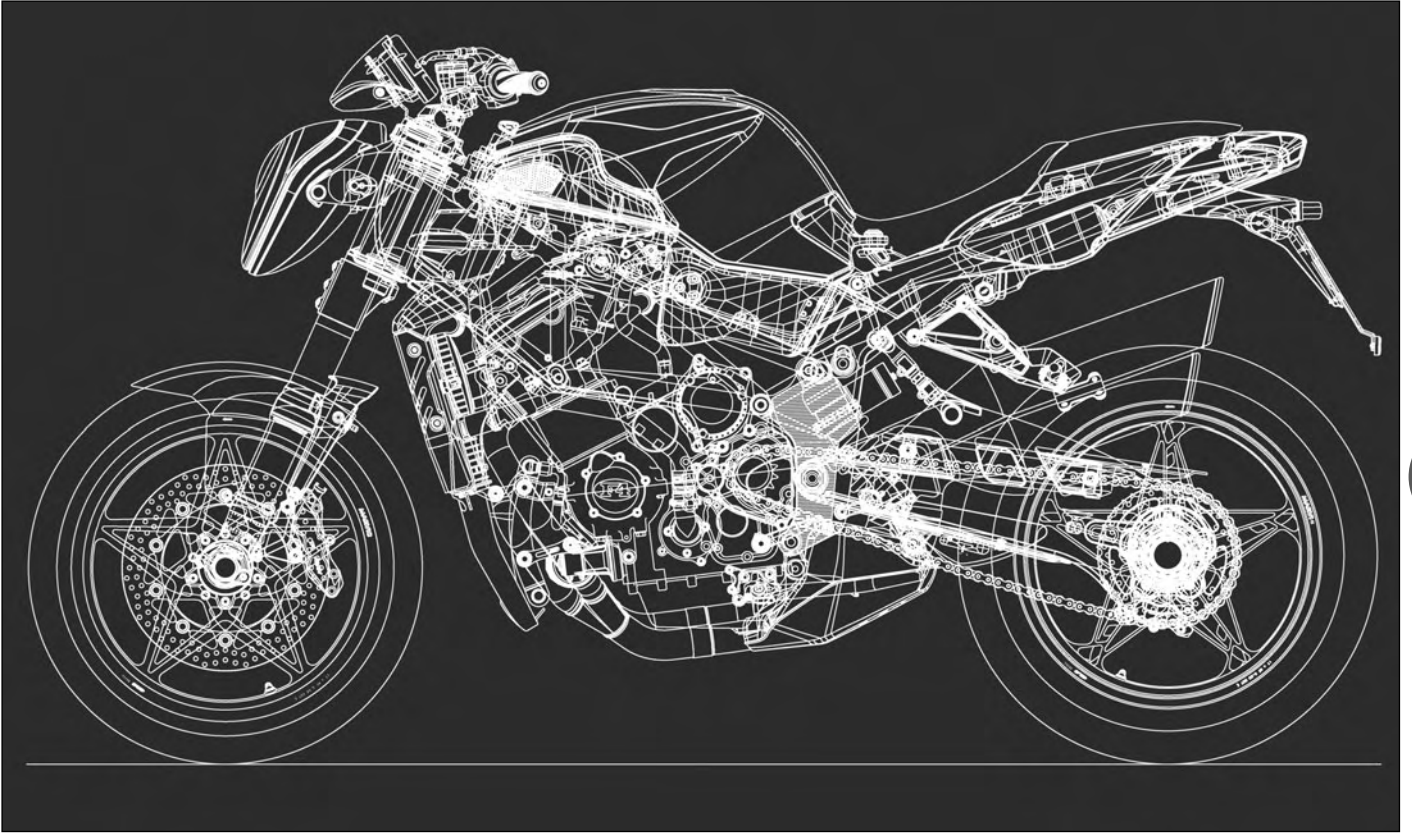

E

SECTION E
Revision 0



SUMMARY

CONNECTORS	PAGE 3
COUPLINGS	PAGE 3
FUSES.....	PAGE 3
SEMICONDUCTOR PARTS.....	PAGE 4
ELECTRICAL DIAGRAM.....	PAGE 5
PARTS LIST	PAGE 6
BATTERY	PAGE 7
INITIAL BATTERY CHARGE	PAGE 7
BATTERY ASSEMBLY.....	PAGE 7
CHARGING SYSTEM.....	PAGE 12
BATTERY EFFICIENCY CHECK.....	PAGE 20
CPU	PAGE 22
FUNCTION DIAGRAM.....	PAGE 22
STARTER SYSTEM	PAGE 23
FUSES.....	PAGE 32
STARTER MOTOR REMOVAL.....	PAGE 32
STARTER MOTOR CHECK.....	PAGE 33
STARTER MOTOR ASSEMBLY	PAGE 33
IGNITION/SIDE STAND SAFETY SYSTEM PARTS CHECK.....	PAGE 35
GEARCHANGE POSITION SWITCH	PAGE 36
SIDE STAND SWITCH.....	PAGE 36
SPARK PLUGS	PAGE 37
INSTRUMENTATION	PAGE 40
OIL PRESSURE SENSOR.....	PAGE 41
FUEL LEVEL WARNING LIGHT CHECK SWITCH	PAGE 41
INSTRUMENT PANEL WATER SENSOR	PAGE 42
KEY IGNITION SWITCH.....	PAGE 42
STARTER RELAY ACTIVATION.....	PAGE 42
LEFT DIRECTION INDICATOR	PAGE 43
RIGHT DIRECTION INDICATOR	PAGE 43
RPM INDICATOR	PAGE 43
SPEED SENSOR	PAGE 43
COOLING FAN SYSTEM.....	PAGE 44
KLAXON.....	PAGE 45
SWITCHES.....	PAGE 46



Electrical system

CONNECTORS

- When a connector is connected, check that it clicks into position.
- Check the connector for corrosion, dirt or a broken cover.

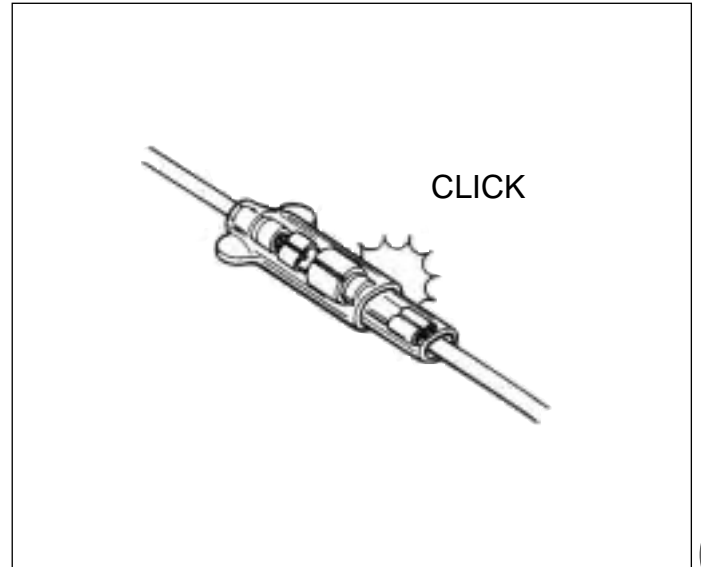

COUPLINGS

- Block couplings – ensure that the block is released before disconnecting it to push it completely home when connecting it.
- When disconnecting a coupling, ensure that the body of the coupling is gripped and do not pull it apart by the leads.
- Check that the terminals of the couplings are not slack or bent.
- Check that the terminals are not corroded or dirty.

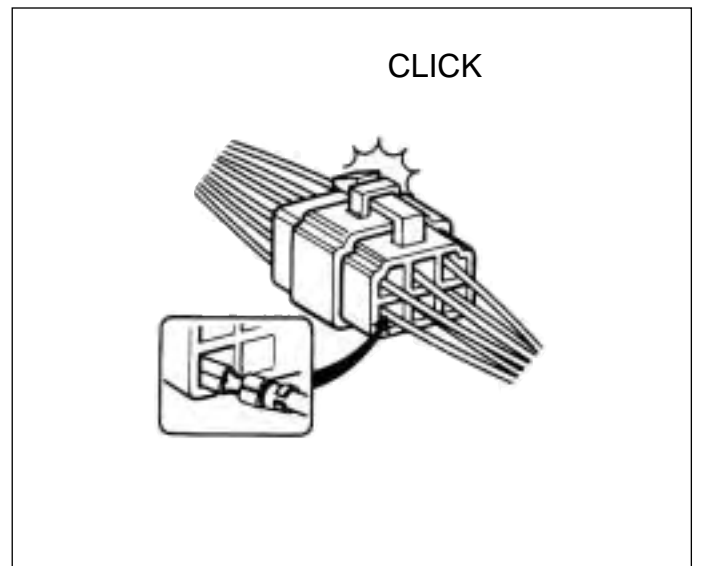

FUSES

- When a fuse burns out, always investigate why the fuse has burnt out. Find the cause, repair and then substitute the fuse.
- Do not utilise a fuse of a different capacity from the original one.
- Do not utilise wire or any other substitute for the fuse.

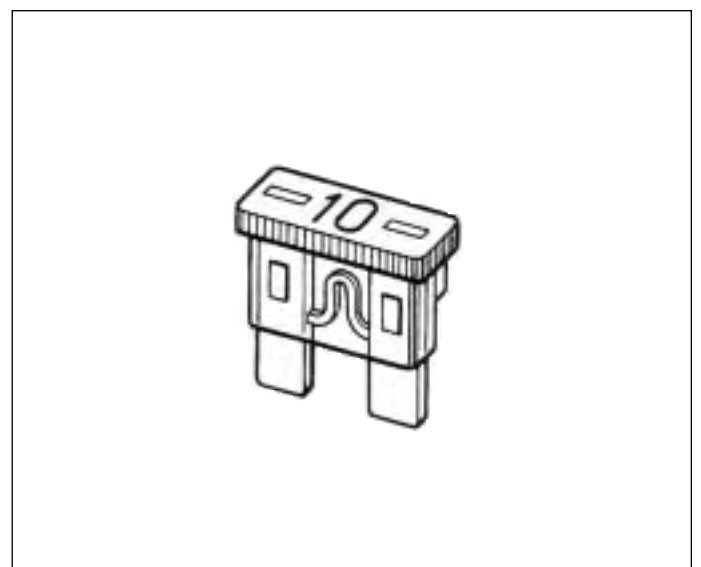

E



SEMICONDUCTOR PARTS

- Pay special attention to not drop parts incorporating semiconductors (ECU, instrument panel, CPU).
- When checking these components, carry out the instruction strictly. The lack of using the correct procedure can cause grave damage.

INCORRECT

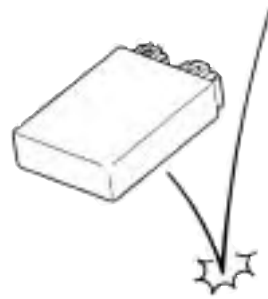



Electrical system

ELECTRICAL DIAGRAM

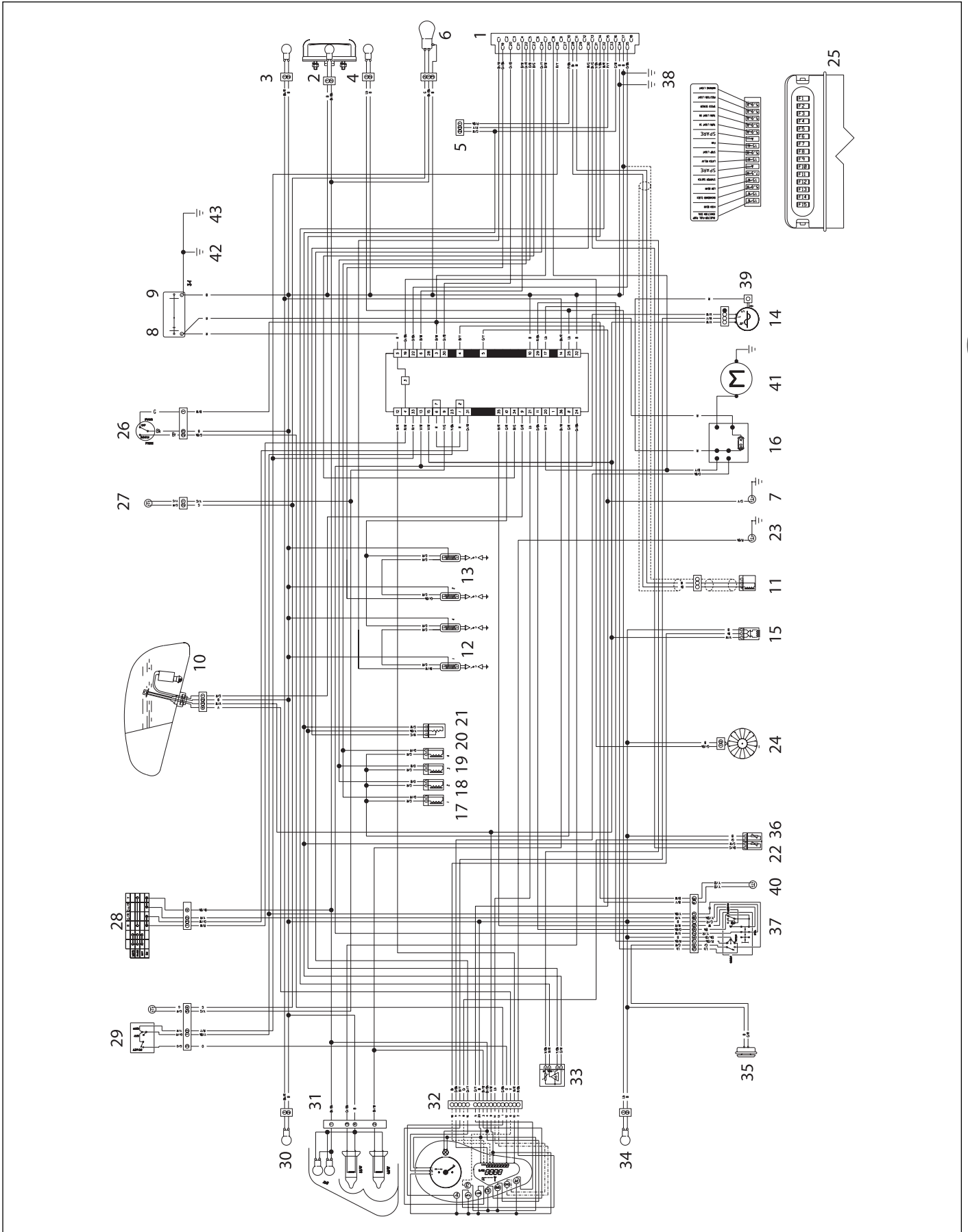



Electrical system

PARTS LIST

Parts list		Parts list		Parts list	
Ref.	Description	Ref.	Description	Ref.	Description
1	CPU	16	Solenoid	32	Instrument panel
2	Number plate light	17-18	Injectors	33	Air temperature/pressure sensor
3	Right indicator	19-20		21	34
4	Left indicator	21	Butterfly potentiometer	35	Horn
5	Diagnostic connector	22	Water temperature sensor – CPU	36	Water temperature sensor for instrument thermometer
6	Rear stop light	23	Oil switch	37	Light switch
7	Neutral switch	24	Electric fan	38	Frame/CPU earth
8-9	Battery	25	Fuses	39	Battery recharge
10	Fuel probe – pump	26	Side stand switch	40	Clutch switch
11	R.p.m. sensor	27	Rear stop switch	41	Starter motor
12	Coil	28	Ignition switch	42	Frame earth
13	Coil	29	Safety and Front stop switch	43	Engine earth
14	Alternator	30	Right indicator		
15	Speed sensor	31	Front headlight		

E

Wiring colour code	
Letter(s)	Colour
R	Red
Y	Yellow
B	Blue
G	Green
W	White
Bk	Black
P	Pink
V	Violet
Sb	Sky blue
Gr	Grey
O	Orange
Br	Brown

In combined colors, background and marking colors have been pointed out. E.g. : Br/Bk.

Fuses list		
Ref.	Amps (A)	Use
F1	5	Instrument panel warning light
F2	5	Side lights
F3	5	Speed sensor
F4	5	Right direction indicator
F5	5	Left direction indicator
F6	15	Electric cooling fan
F7	5	Rear headlight/stop light
F8	15	Latch relay
F9	7.5	Starter switch
F10	15	Dipped beam headlight
F11	5	Instrument panel clock
F12	15	Main beam headlight
F13	15	Injectors-Fuel pump-Coils
F14	40	Battery recharge
F15	40	Spare for battery recharge



Electrical system

BATTERY

The battery mounted on this motorcycle is a sealed battery therefore no maintenance is required.
The batteries recommended are the following:
- YUASA YTX10-S (pre-activated).



INITIAL BATTERY CHARGE

Proceed with charging following the method on the packet that the battery came in or as indicated in the following table.

Charging method

It is preferable to charge the battery at a constant voltage to not overcharge battery as follows:

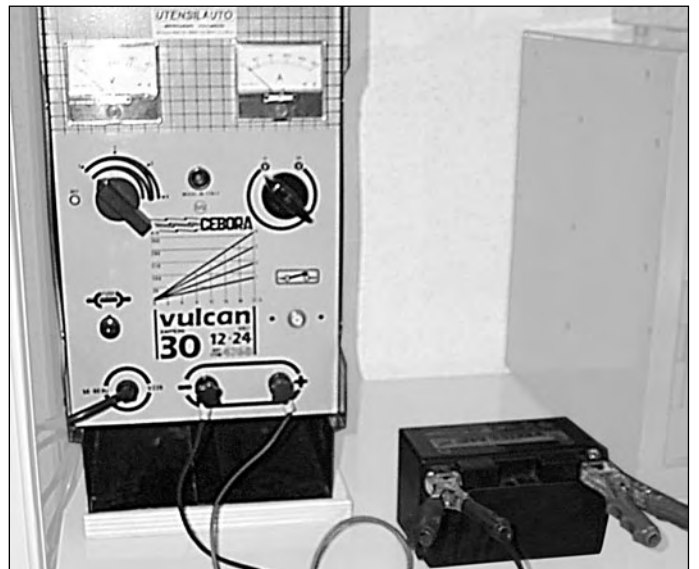

BATTERY ASSEMBLY

Insert the motorcycle key into the rear lock. Turn the key clockwise while lifting the passenger seat up.

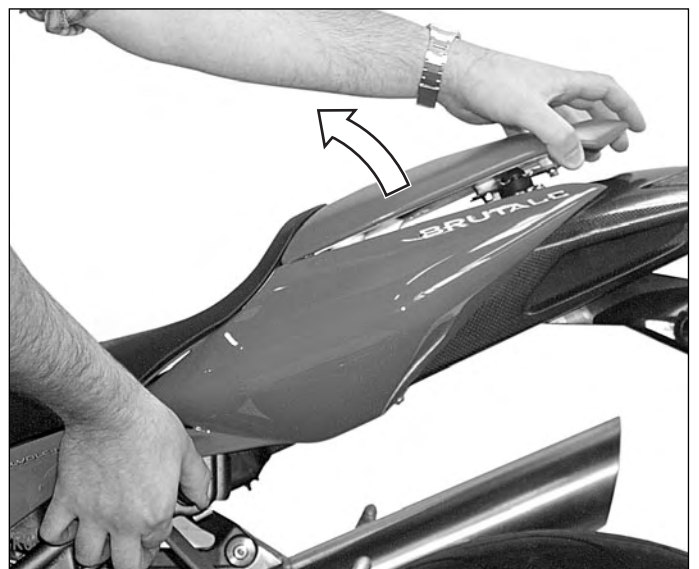



Electrical system

Remove the passenger seat as shown in the figure.

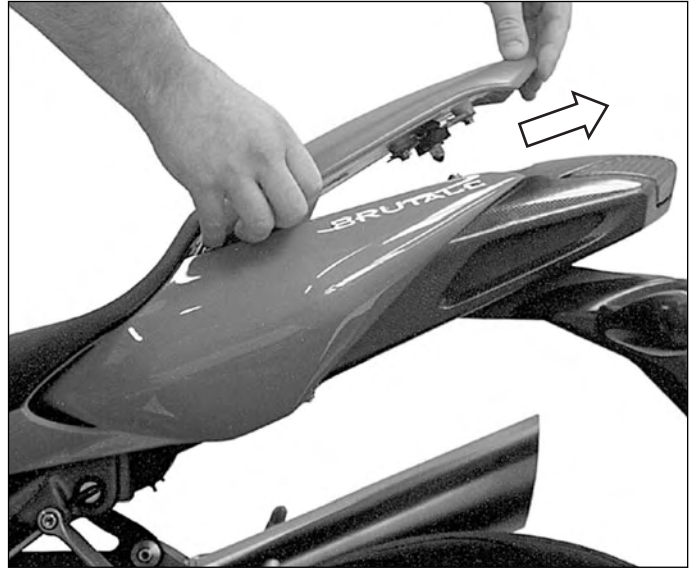

E

Rotate the rider seat fastener as shown in the figure.



Lift up the rider seat and remove it.





Electrical system

Insert the battery into the appropriate compartment.



The initial battery charge should be carried out before mounting it on the motorcycle.



E

Battery terminal assembly

Assemble the two positive (+) terminal leads on the relative battery pole, respecting the order shown in the figure.

Pay attention to the colours of the cable in order to position them correctly.



Rotate the screw of positive terminal leads and tighten to the prescribed torque using a torque wrench.



Torque pressure: 7 ÷ 8 N•m





Electrical system

When the terminals are mounted replace the **protection cover** on the positive pole (see figure).

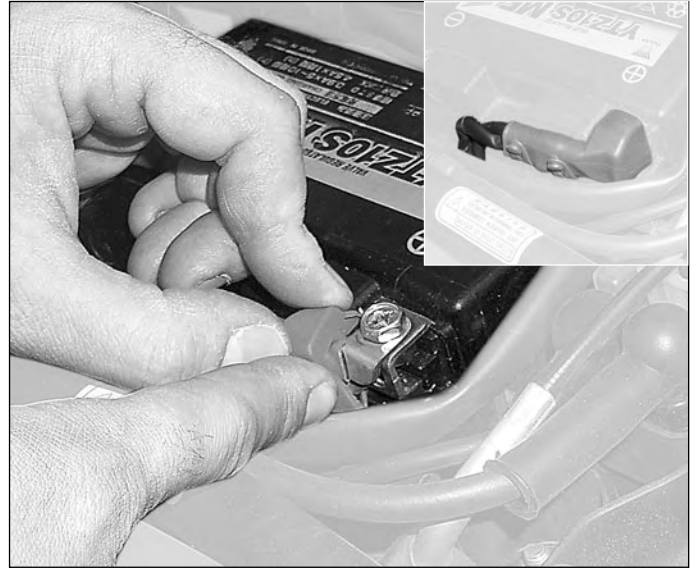

Connect the two negative (-) terminal leads to the relative pole of the battery respecting the placing shown in the figure.



Rotate the screw of negative terminal leads and tighten to the prescribed torque, using a torque wrench.



Torque pressure: 7 ÷ 8 N•m



Before tightening, make sure that the cables are oriented correctly.





Electrical system



After the assembly operation, make sure that the positive terminal cable is positioned correctly inside the rear frame unit (see figure).

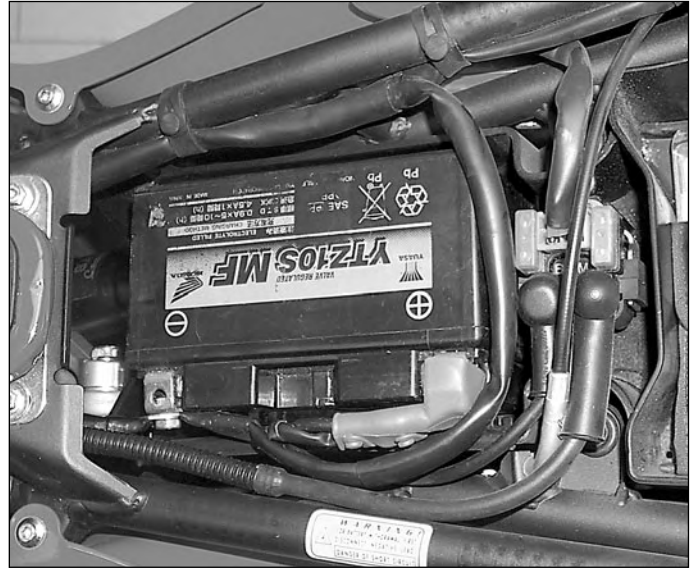

E

PLACEMENT AND ASSEMBLY OF TERMINALS (WIRE TERMINALS) ON THE BATTERY

NEGATIVE WIRE (-)

NEGATIVE POLE (-)

NEGATIVE WIRE (-)

CAUTION: Before tightening, ensure that the wires are correctly oriented (see the figure)

POSITIVE WIRE (+)

ATTENTION: After having finished the assembly, ensure that the positive terminal wire is placed inside the rear sub-frame structure (see the figure)

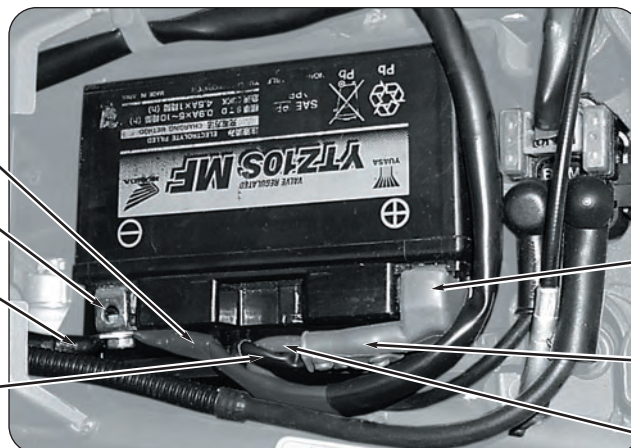

POSITIVE POLE (+)

PROTECTION COVER

POSITIVE WIRE (+)



Electrical system

CHARGING SYSTEM

The system of the charging circuit illustrated as follows is substantially composed of a generator and a rectifier/regulator, enclosed in one component. The alternating current (AC) is transformed into direct current (DC) by the rectifier, regulated and therefore utilised for charging the battery.

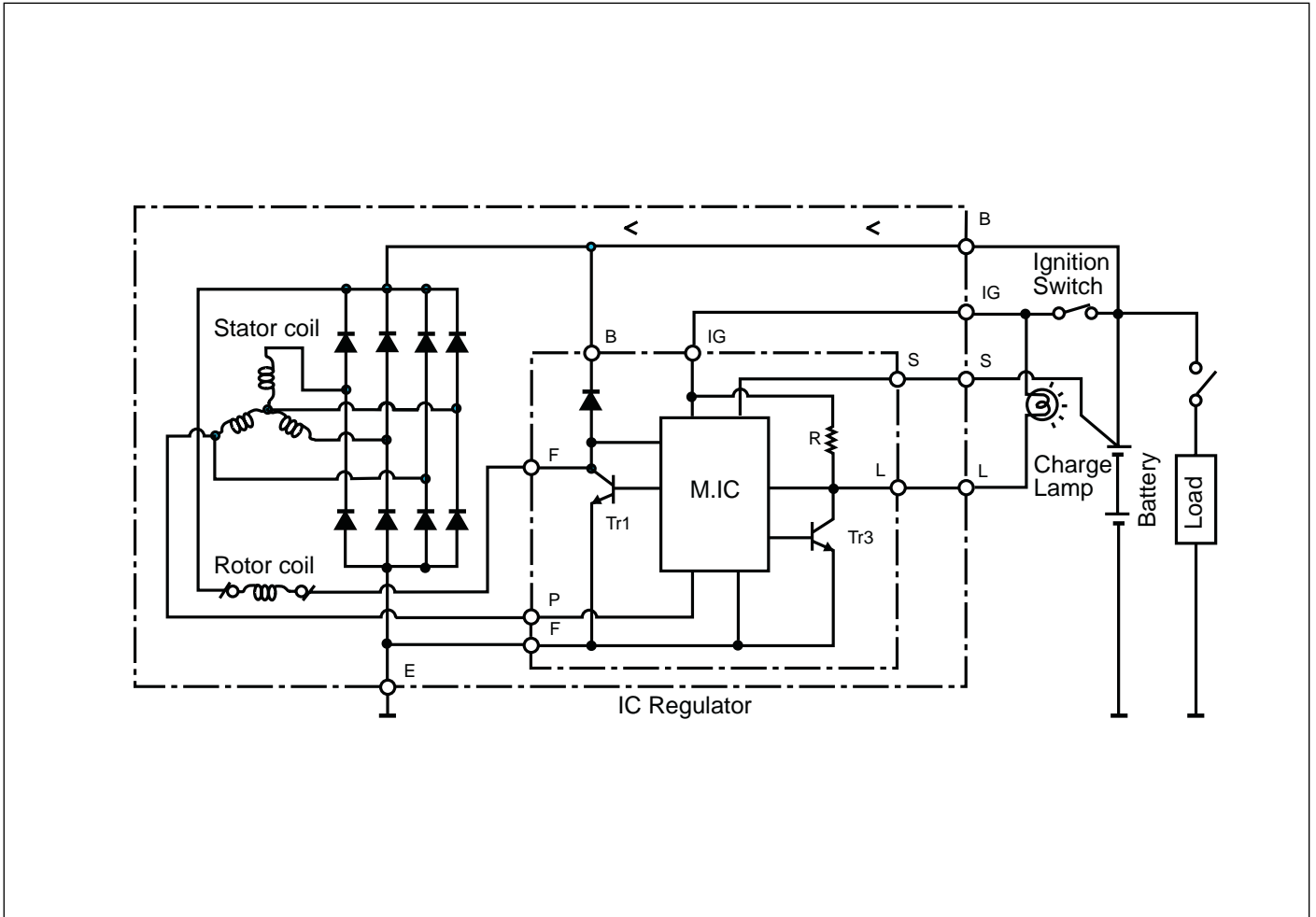

Warning function

- Disconnection of the coil
- Disconnection of the regulator
- Disconnection of terminal B (voltage at terminal S is less than 13 volts)

Any one of these abnormalities switches on the warning light on the instrument panel.

As shown in the figure, the temperature influences the characteristics of the regulator with steps of variation of the regulated voltage.

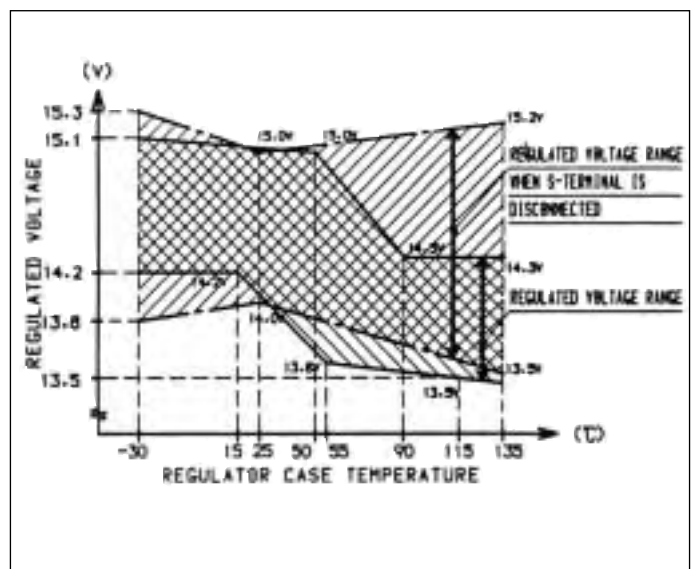



Electrical system

In the preceding diagram is illustrated the complete charging circuit. The input circuit of the regulator includes the integrated M-IC that, being complex in its various functions will be simply indicated as M-IC.

(1) Ignition switch "ON" with engine off.

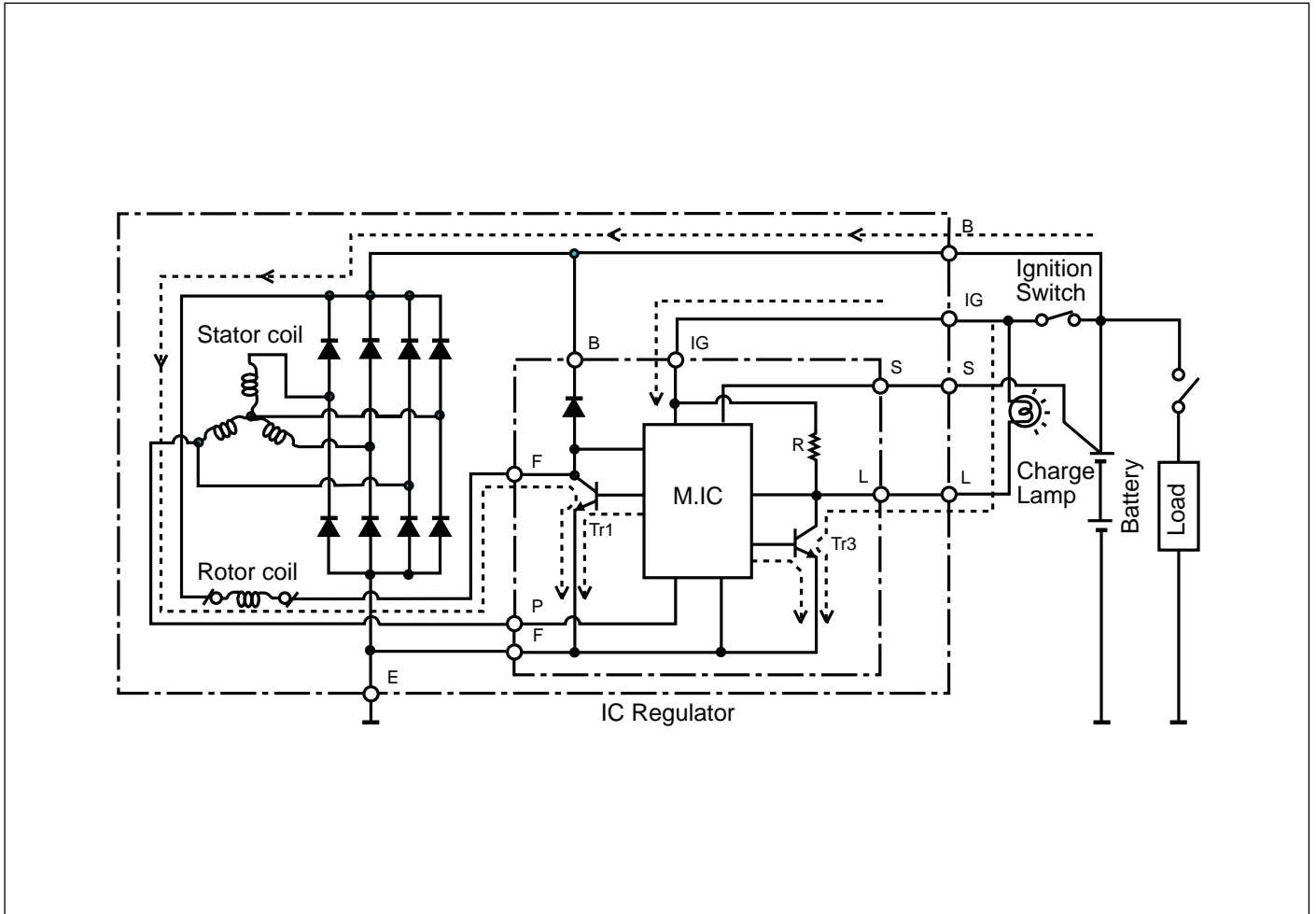

The M-IC reveals the battery voltage applied to the IG terminal and activates Tr1. The initial current passes via the rotor coil (to reduce the battery charge to the minimum when it is in this condition), Tr1 passes from "ON" to "OFF" intermittently thereby reducing the absorption of the system to 0.17A.

During this period the generator is not functioning and does not generate any voltage. The voltage at point P is 0V and M-IC revealing this value, activates Tr3 which switches on the warning light.



Electrical system

(2) Recharging (voltage less than the regulated voltage).

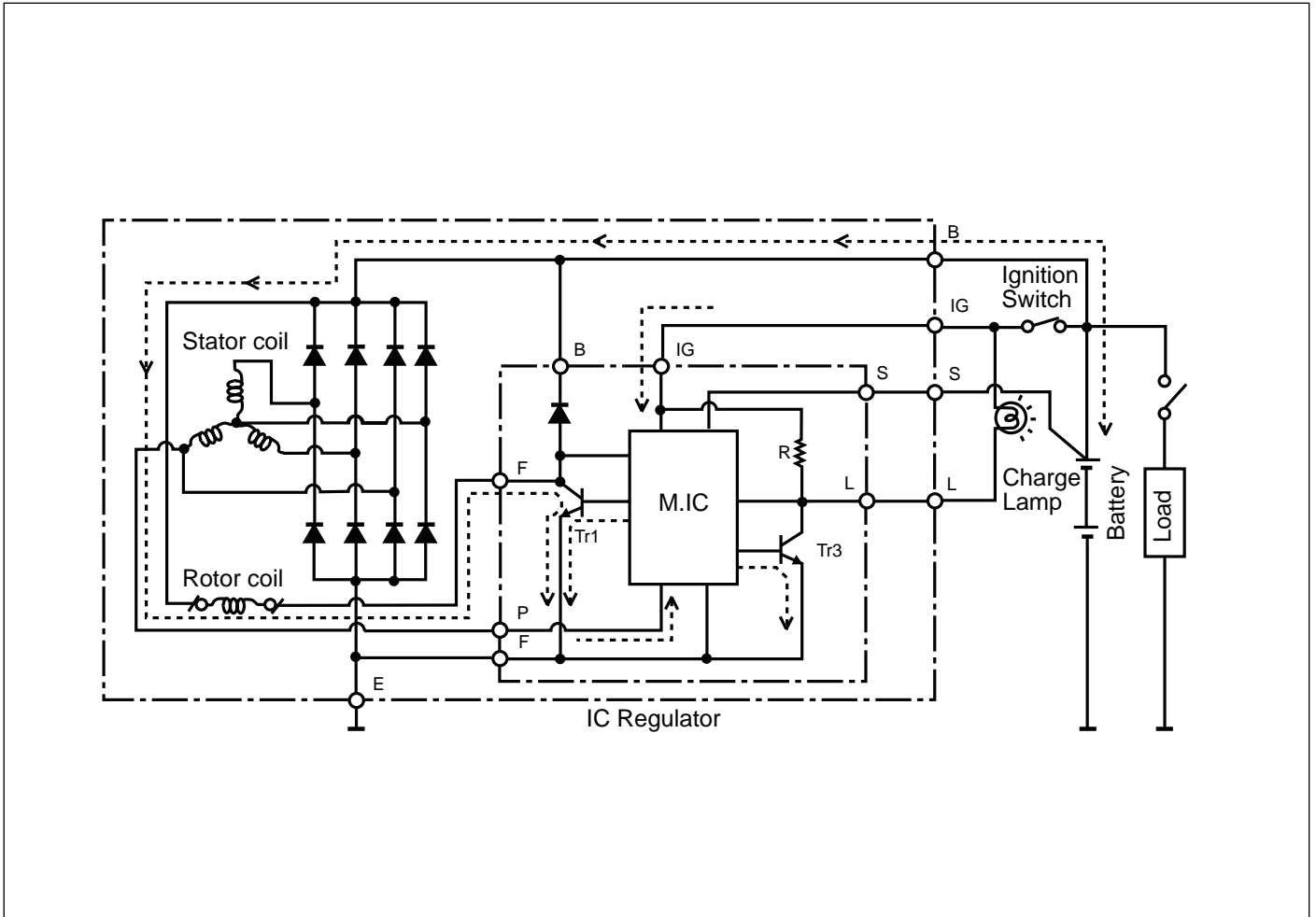

Once the engine is switched on, the M-IC makes the Tr1 pass from an intermittent “ON” and “OFF” condition to a stabilised “ON” condition to guarantee an abundant flow of current and a rapid recharge. At this point, the M-IC disactivates also Tr3 that switches off the warning light. When the voltage at terminal B exceeds the battery voltage, then the battery starts recharging.

(4) Rotor coil disconnected.

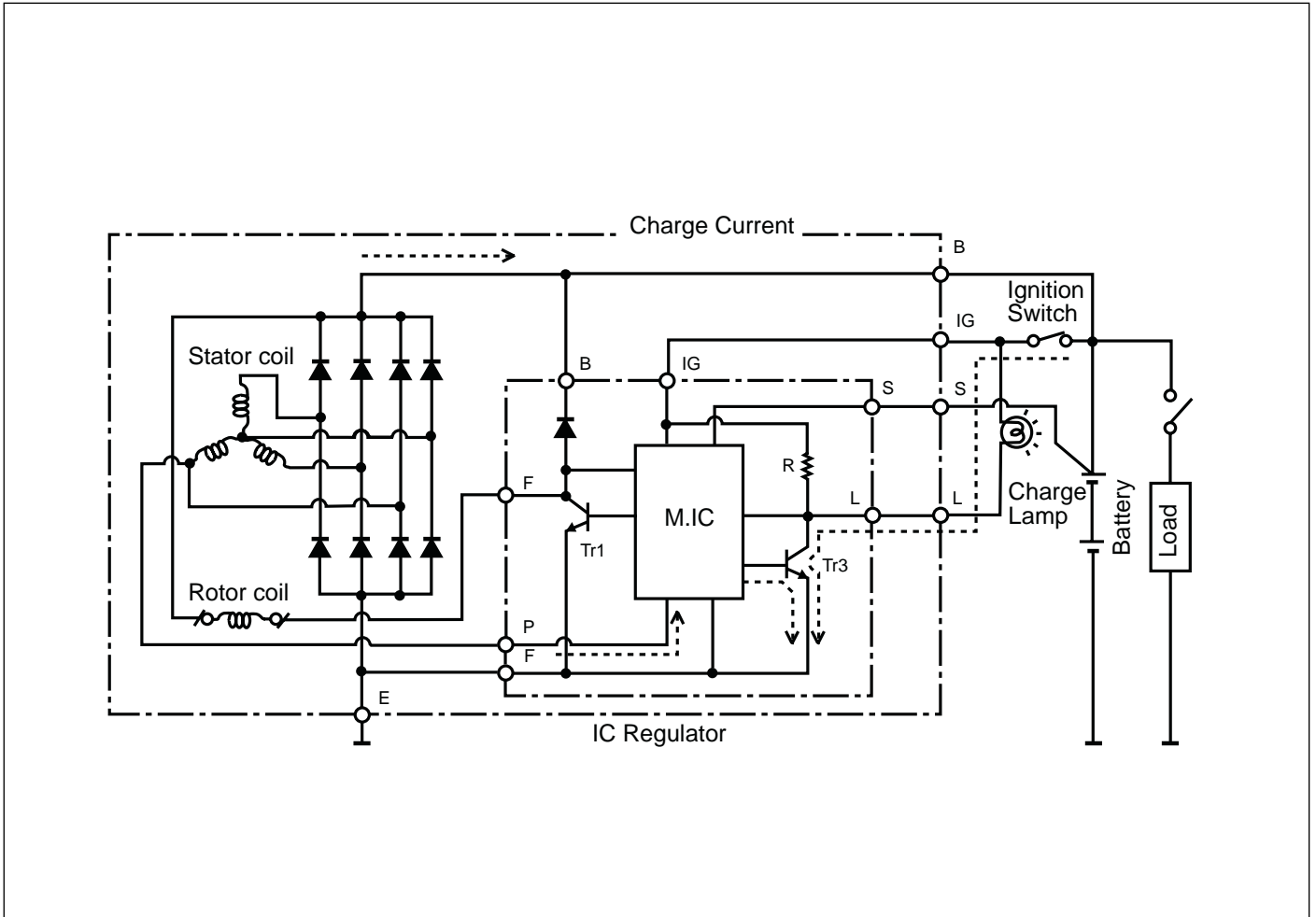

If the rotor coil is disconnected whilst the generator is functioning, the generator interrupts the current and the voltage at terminal P goes to zero.
The M-IC reveals this condition and through the Tr3 switches on the warning light.

(5) Disconnection of terminal S of the regulator.

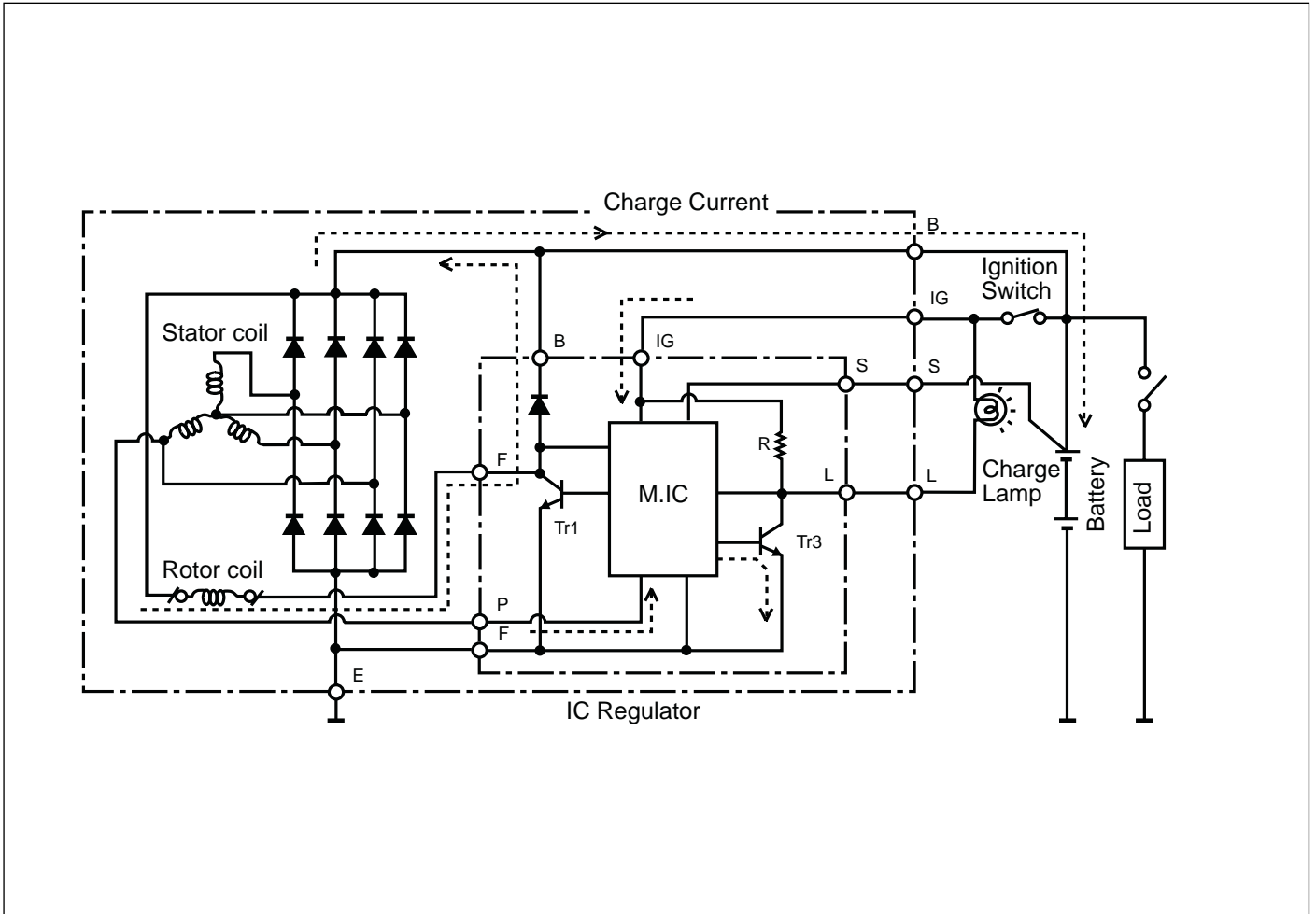

If a reference voltage does not arrive at terminal S whilst the alternator is functioning, the M-IC reveals it and through Tr3 switches on the warning light. At this point the M-IC, to maintain the voltage at terminal B between 13.3V and 16.3V activates and disactivates Tr1.

(6) Terminal B disconnected.

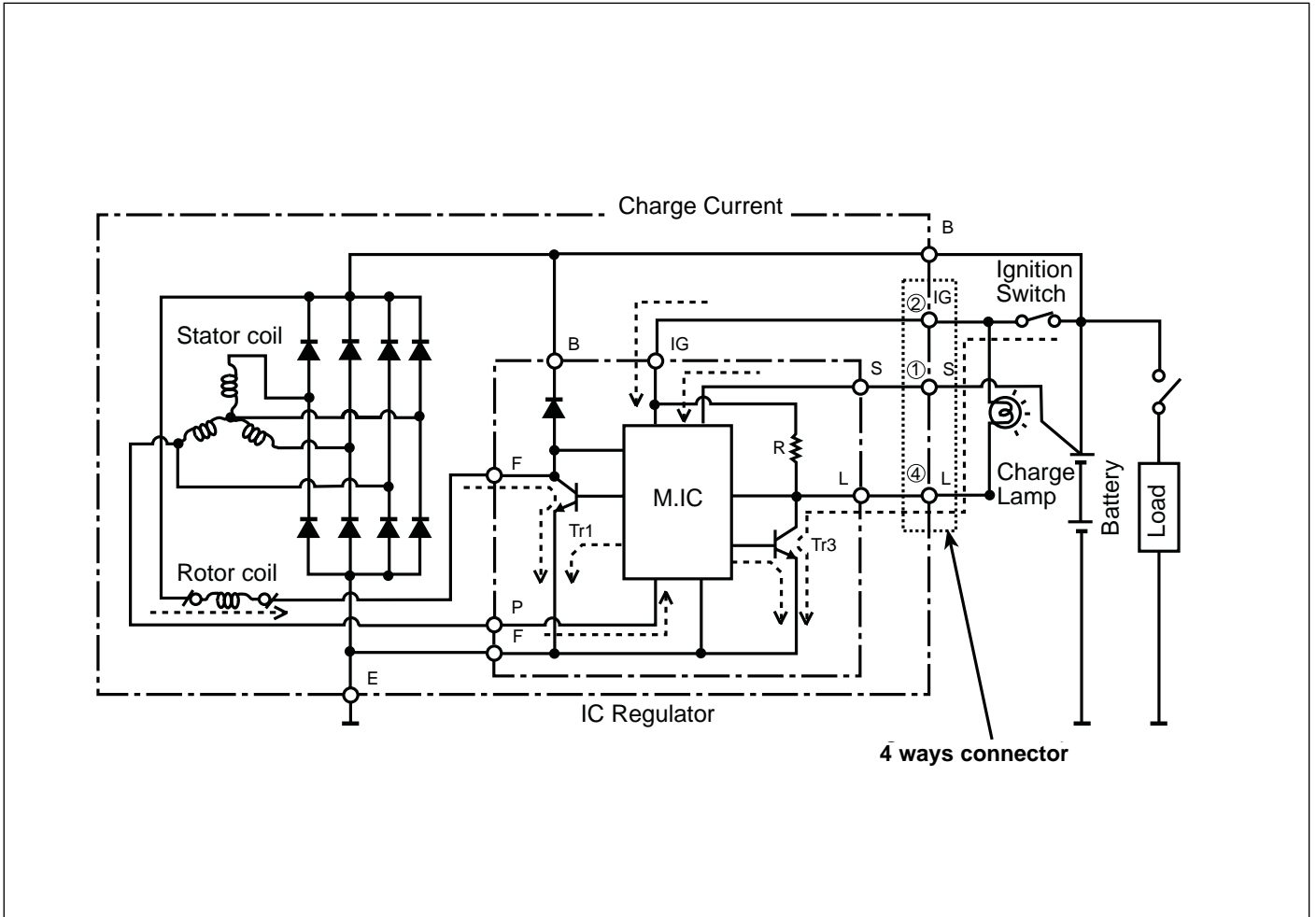

If terminal B is disconnected whilst the alternator is functioning, the voltage of the battery gradually drops until it starts discharging. As long as the voltage at terminal S is more than 13V the M-IC maintains the voltage at terminal B at 20V, protecting the alternator and the rectifier in the moment in which the voltage at terminal S drops under 13V. The M-IC reveals it through Tr3 and activates the warning light.



Electrical system

A list of possible problems that could occur when the warning light is switched on.

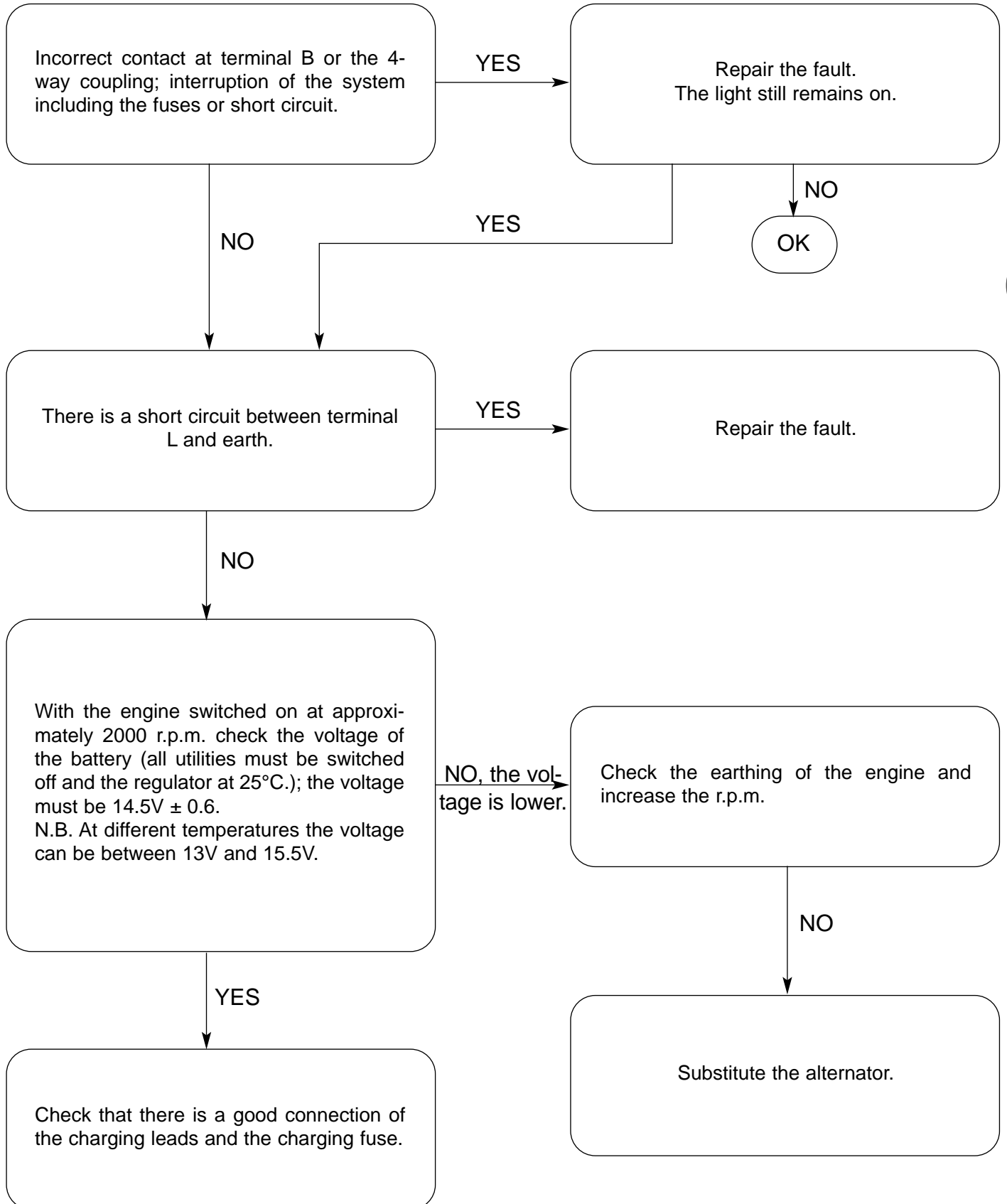

E



Electrical system

BATTERY EFFICIENCY CHECK

Battery current loss check

- Remove the tail unit as described in chapter C “Bodywork”.
 - Turn the ignition switch to the “OFF” position.
 - Disconnect the cable from the negative (-) pole of the battery.
 - Connect the multi-tester between the negative (-) terminal and the negative (-) cable of the battery.
- Losses are indicated if the tester measures more than 2-2.5mA.

Battery current loss: less than 1mA

E First of all when using an ampmeter, utilise a high range of the multi-tester because the current losses in the case of malfunctioning could be elevated.



If losses are found, search for the part where the tester measures less than 2-2.5mA by removing couplings and connectors one at a time.

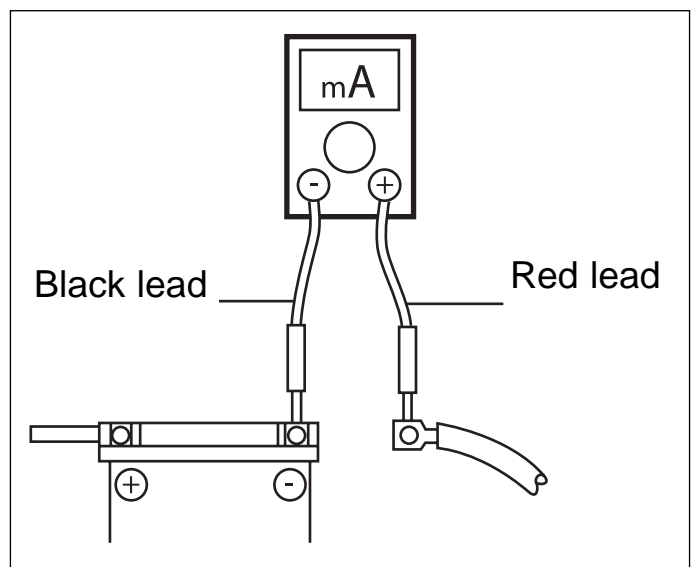



Electrical system

Charge feed check

- Remove the tail unit
- Switch on the engine and run it at 2000 r.p.m. with the light switch in the "ON" position and the selector on main beam HI.



Measure the voltage between the positive (+) and negative (-) terminals of the battery with a multi-tester. If the tester indicates less than 12.6V or more than 14.3V the cause will be found in the generator.

N.B. When carrying out this check, ensure that the battery is fully charged.

Standard recharge voltage:
12.6 - 14.3V at 2000 r.p.m.

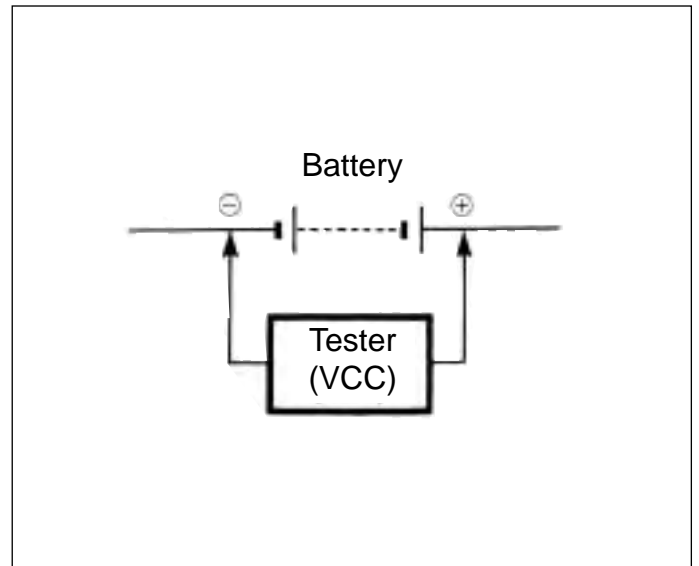

E



Electrical system

CPU

The CPU includes a group of functions previously performed by other components of the motorcycle. This allowed to simplify wiring and to reduce connections. The general reliability of the unit is enhanced and overall weight is reduced.

FUNCTION DIAGRAM

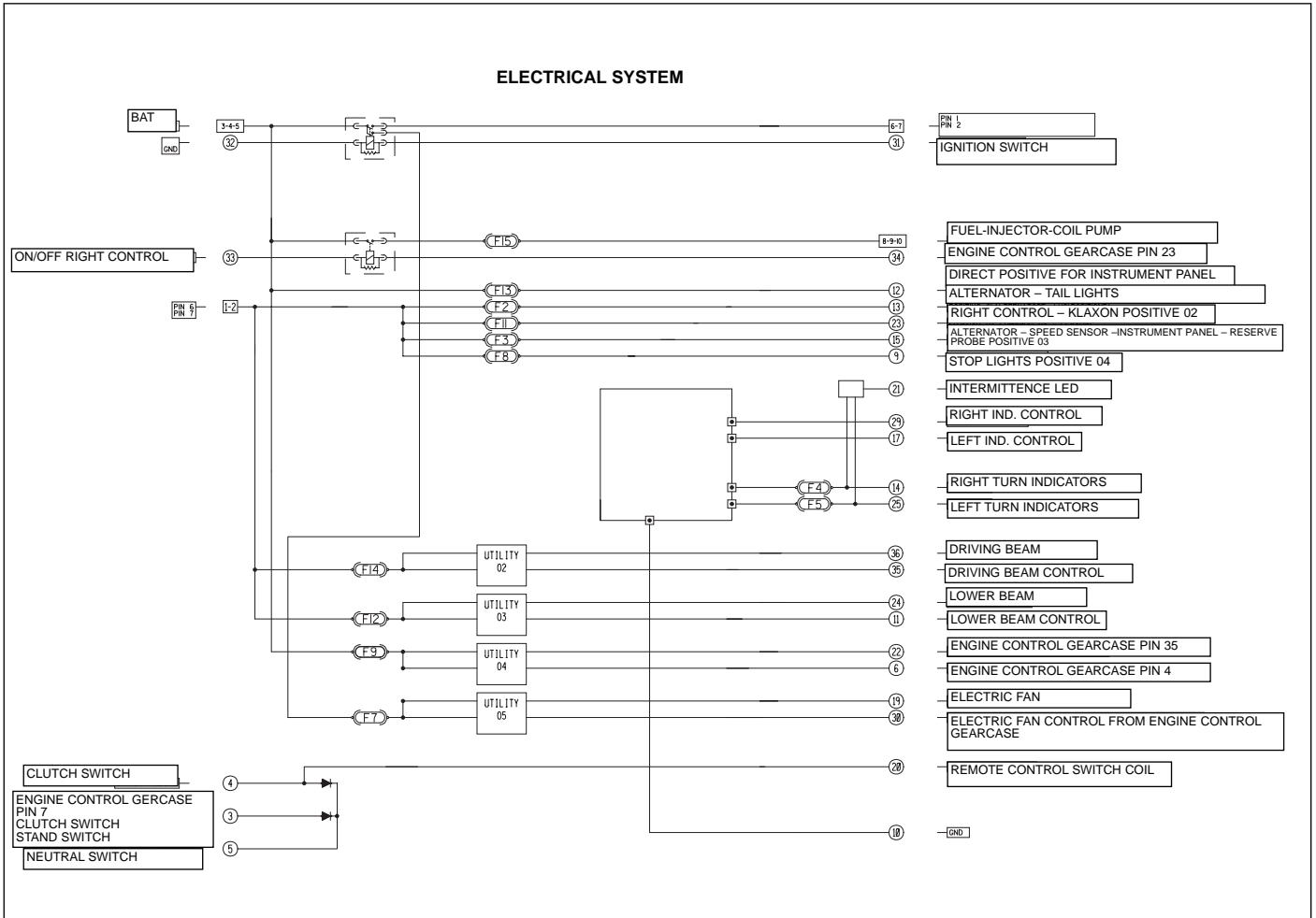

- A – with neutral engaged, the contact is closed.
- B – for ECU with “Pull up” input to battery voltage or for negative coil ignition feed relay.
- C – side stand switch.
- D – Neutral warning light.
- E – Side stand lowered warning light position.
- F – Clutch switch.
- G – 1N5404 diode.
- H – Engine start switch.



Electrical system

STARTER SYSTEM

The diagram below represents the starter system.

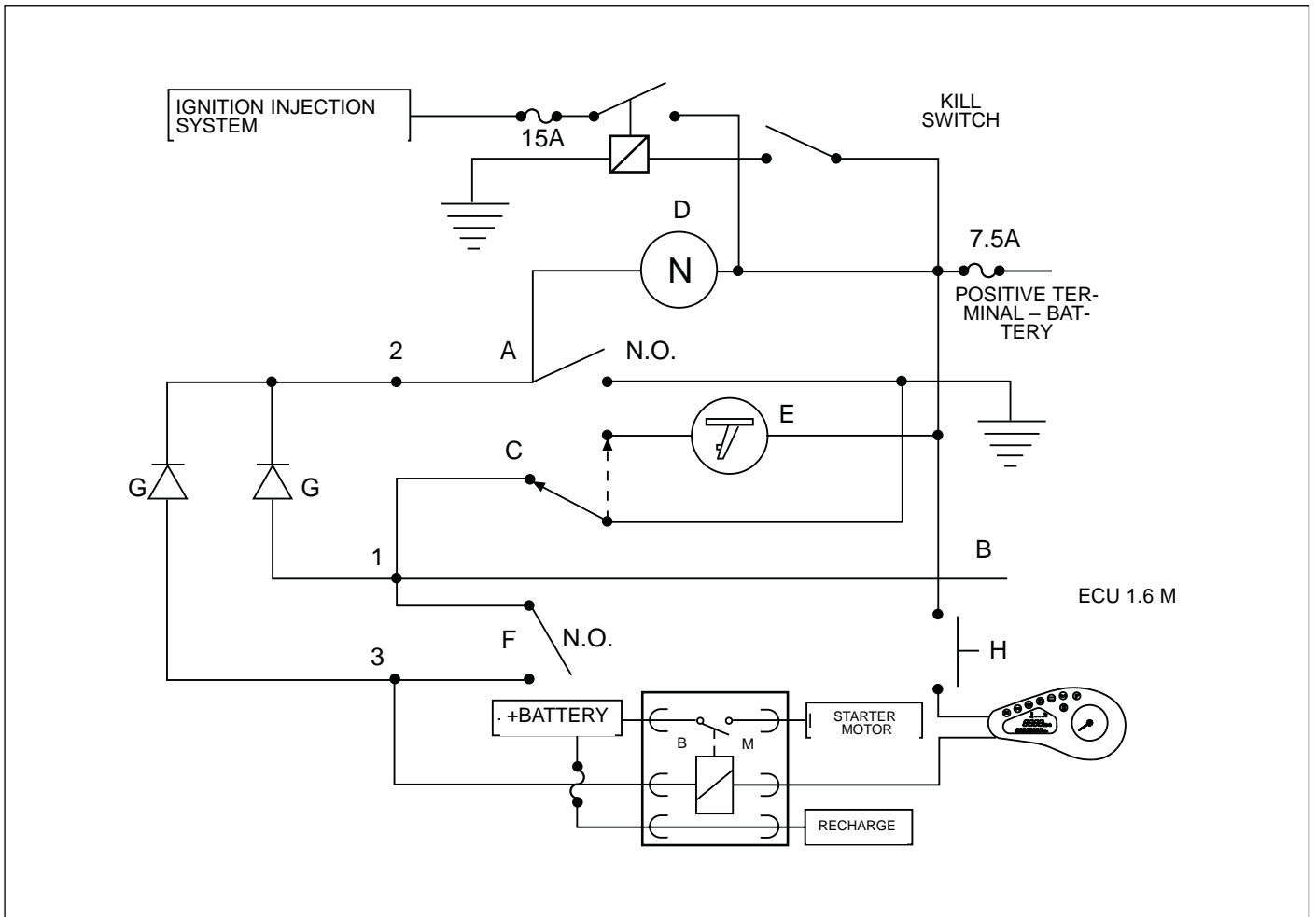

	IN			EFFECT	
	GEAR POSITION	STAND POSITION	CLUTCH LEVER POSITION	START SWITCH DISABLED	ENGINE LOCKED OFF
1	I	I	I	NO	NO
2	I	O	I	NO	NO
3	I	I	O	NO	NO
4	I	O	O	NO	NO
5	O	O	I	NO	NO
6	O	I	I	SI	SI
7	O	I	O	SI	SI
8	O	O	O	SI	NO

GEAR	I: neutral condition
	O: not neutral condition

STAND	I: down
	O: up

CLUTCH LEVER	I: pulled lever
	O: leaved lever

ELECTRIC START LOCKED DISABLED	Start switch disabled
--------------------------------	-----------------------

ENGINE LOCKED OFF	Engine forced off
-------------------	-------------------



Electrical system

Ignition key in the "OFF" position

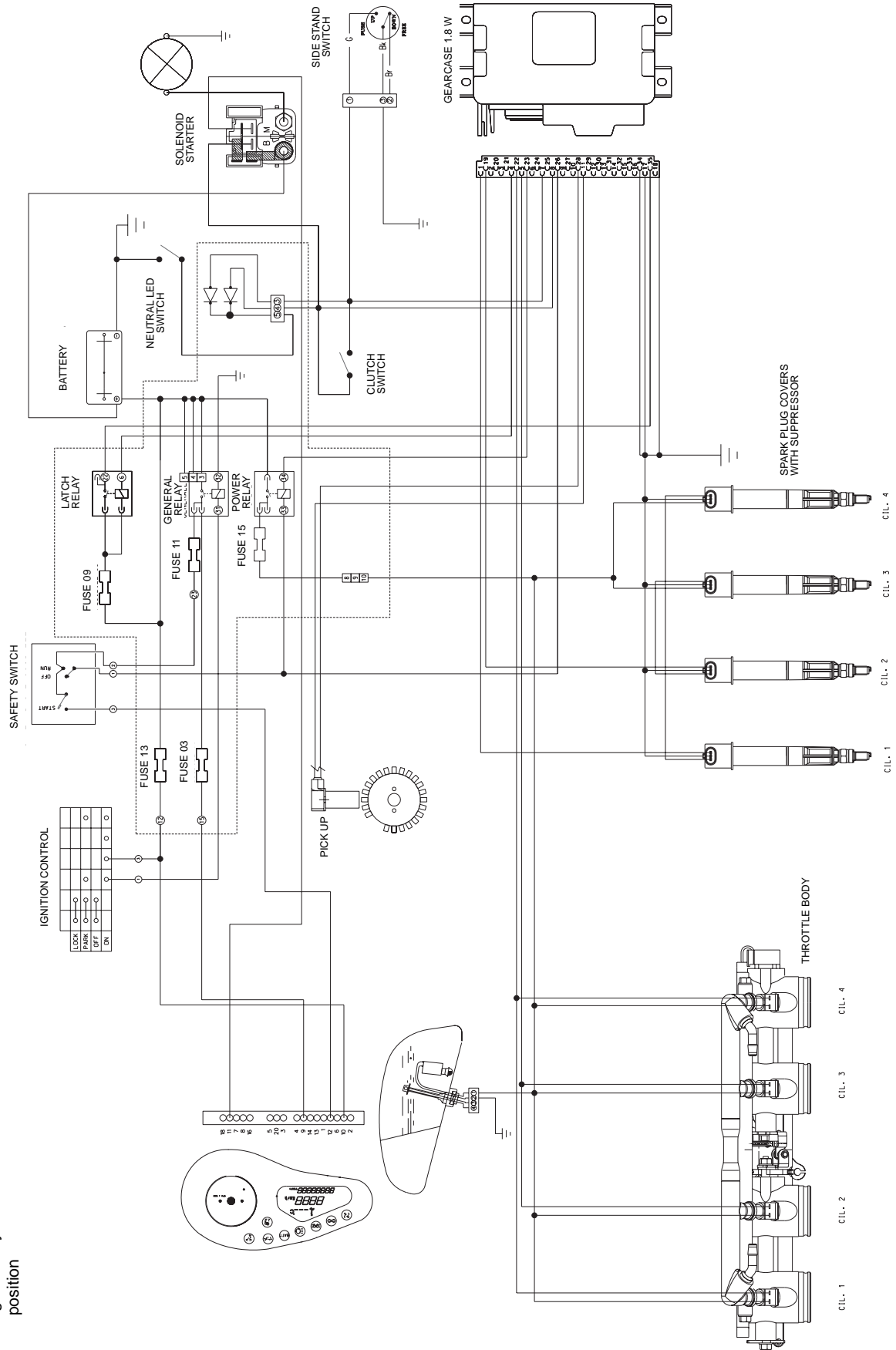



Electrical system

- Ignition key in the "ON" position
- Safety switch in the "RUN" position
- Start activated
- Side stand lowered
- Gear engaged
- Clutch not pulled in
- Engine not switched on

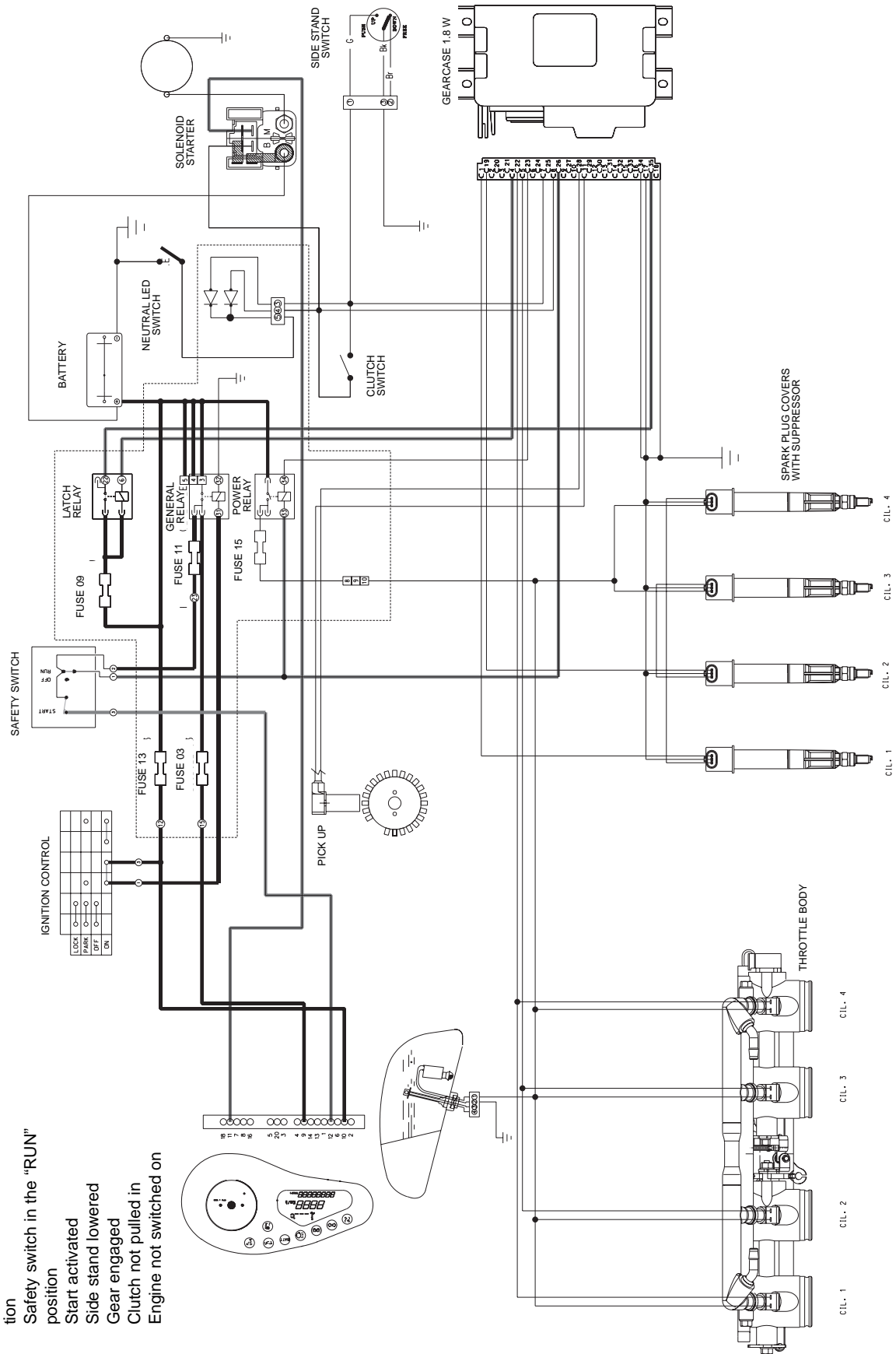

IGNITION CONTROL	
LOCK	○
PARK	○
OFF	○
ON	○





Electrical system

Ignition key in the "ON" Position
 Safety switch in the "OFF" Position

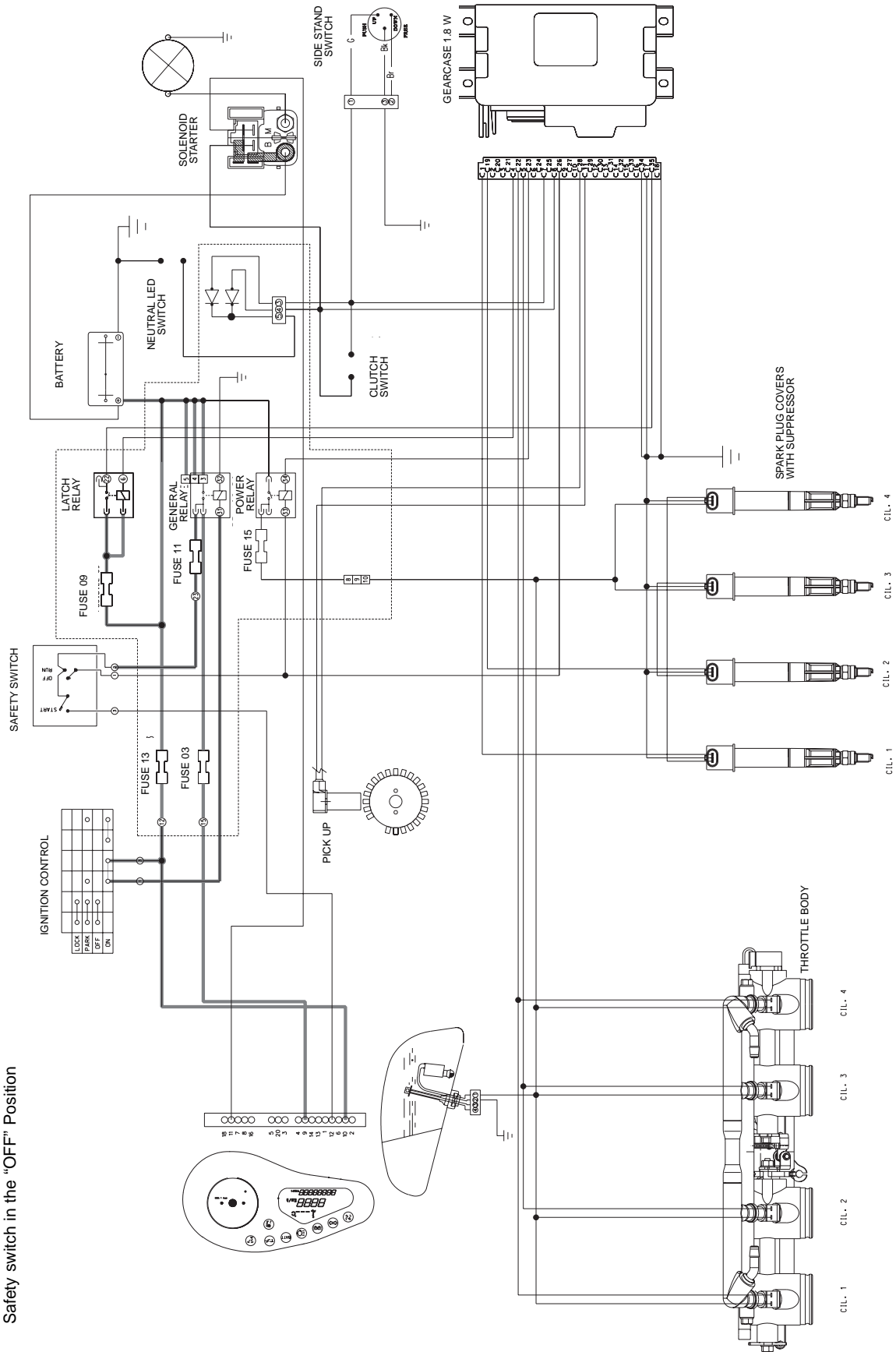

E



Electrical system

- Ignition key in the "ON" position
- Safety switch in the "RUN" Position
- Start activated
- Side stand raised
- Gear engaged
- Clutch released
- Engine switched on

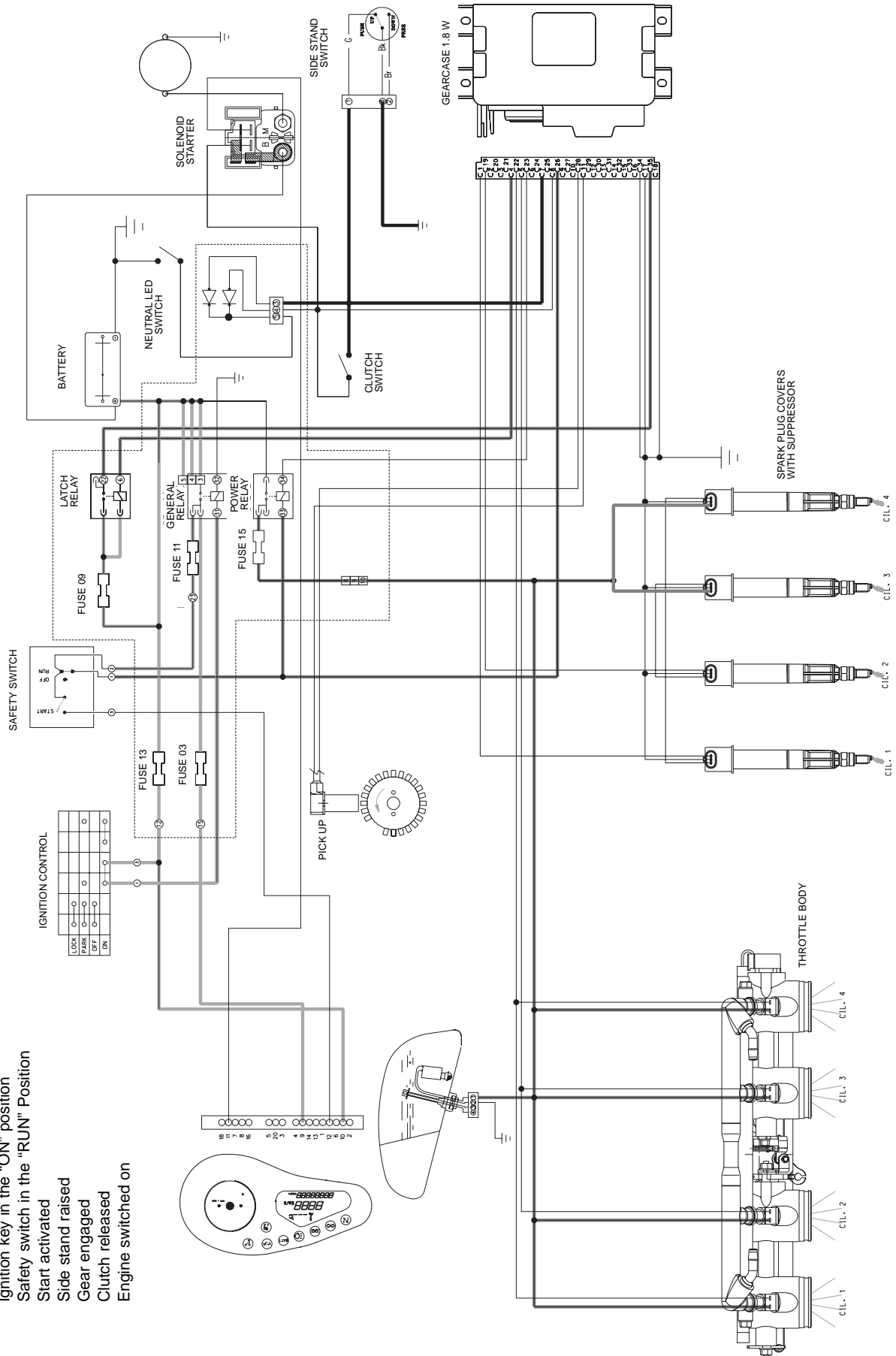



Electrical system

- Ignition key in the "ON" position
- Safety switch in the "RUN" position
- Start activated
- Side stand raised
- Gear engaged
- Clutch pulled in
- Engine switches on

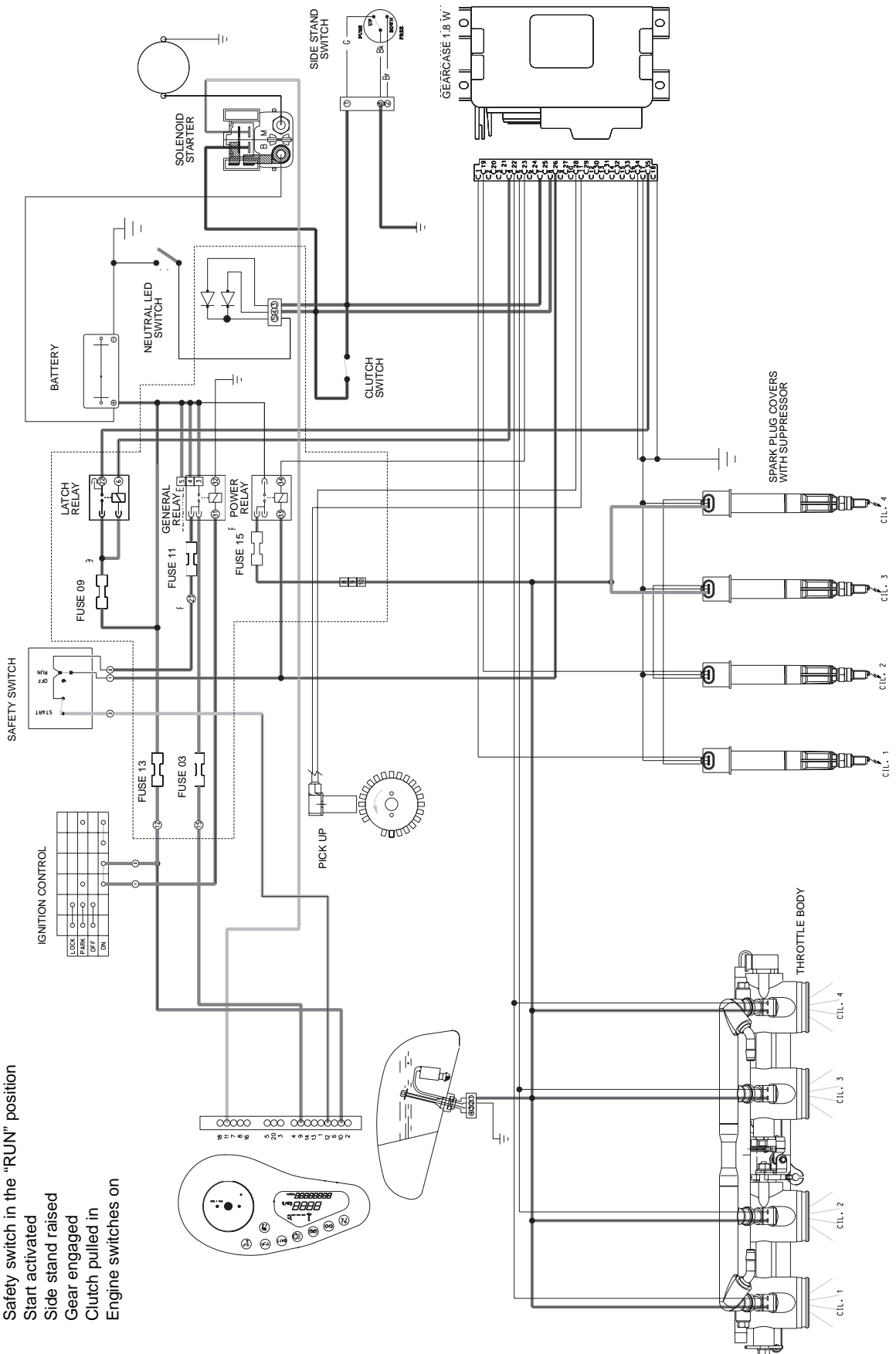

IGNITION CONTROL

LOCK	0	0	0	0	0	0	0	0	0
PARK	0	0	0	0	0	0	0	0	0
ON	0	0	0	0	0	0	0	0	0





Electrical system

Ignition key in the "ON" position
 Safety switch on the "RUN" position
 Start activated
 Side stand lowered
 Gear engaged
 Clutch pulled in
 Engine does not switch on

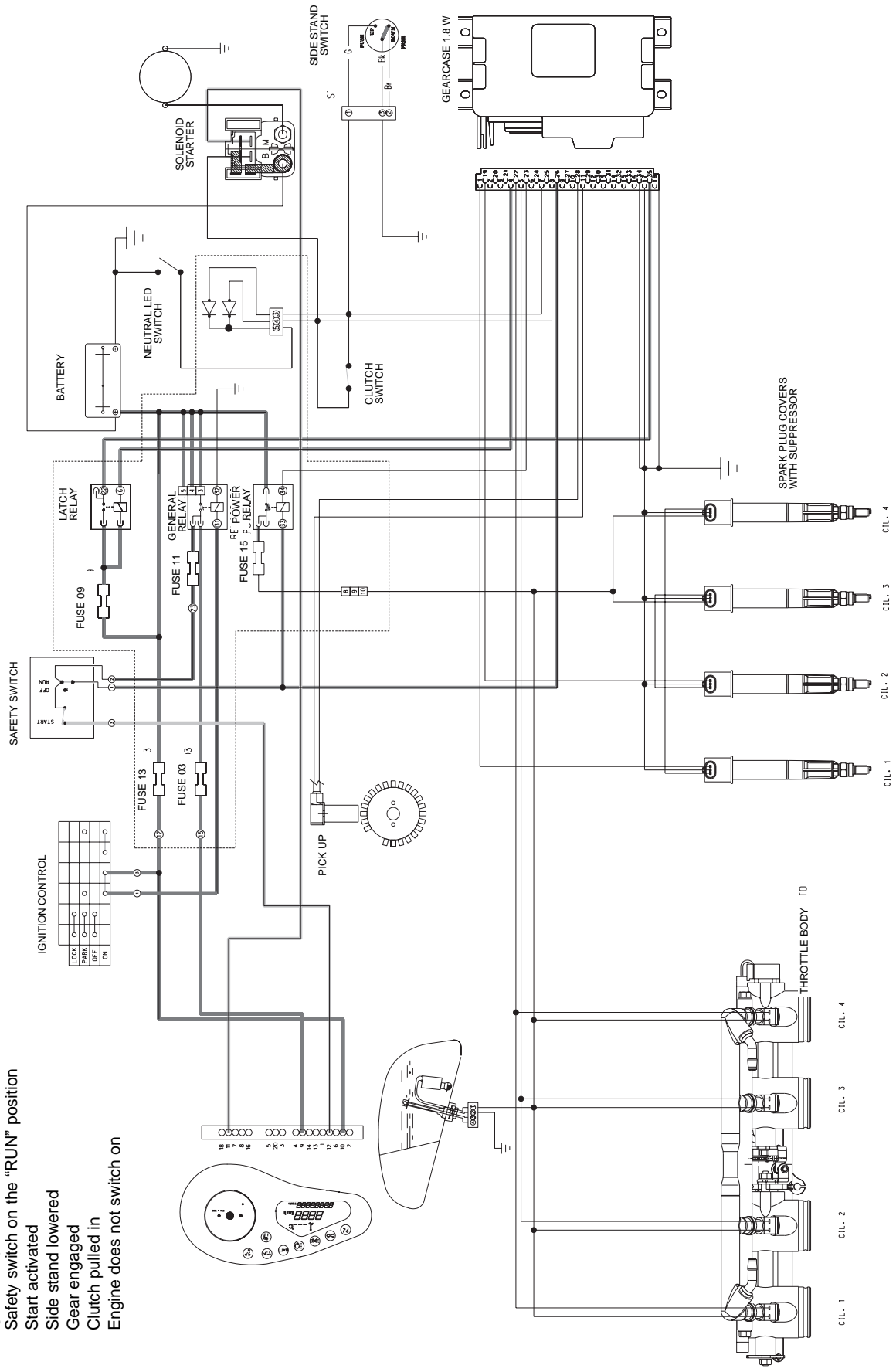

M



Electrical system

- Ignition key in the "ON" position
- Safety switch in the "RUN" position
- Start activated
- Side stand lowered
- Gear not engaged
- Clutch not pulled in
- Engine switched on

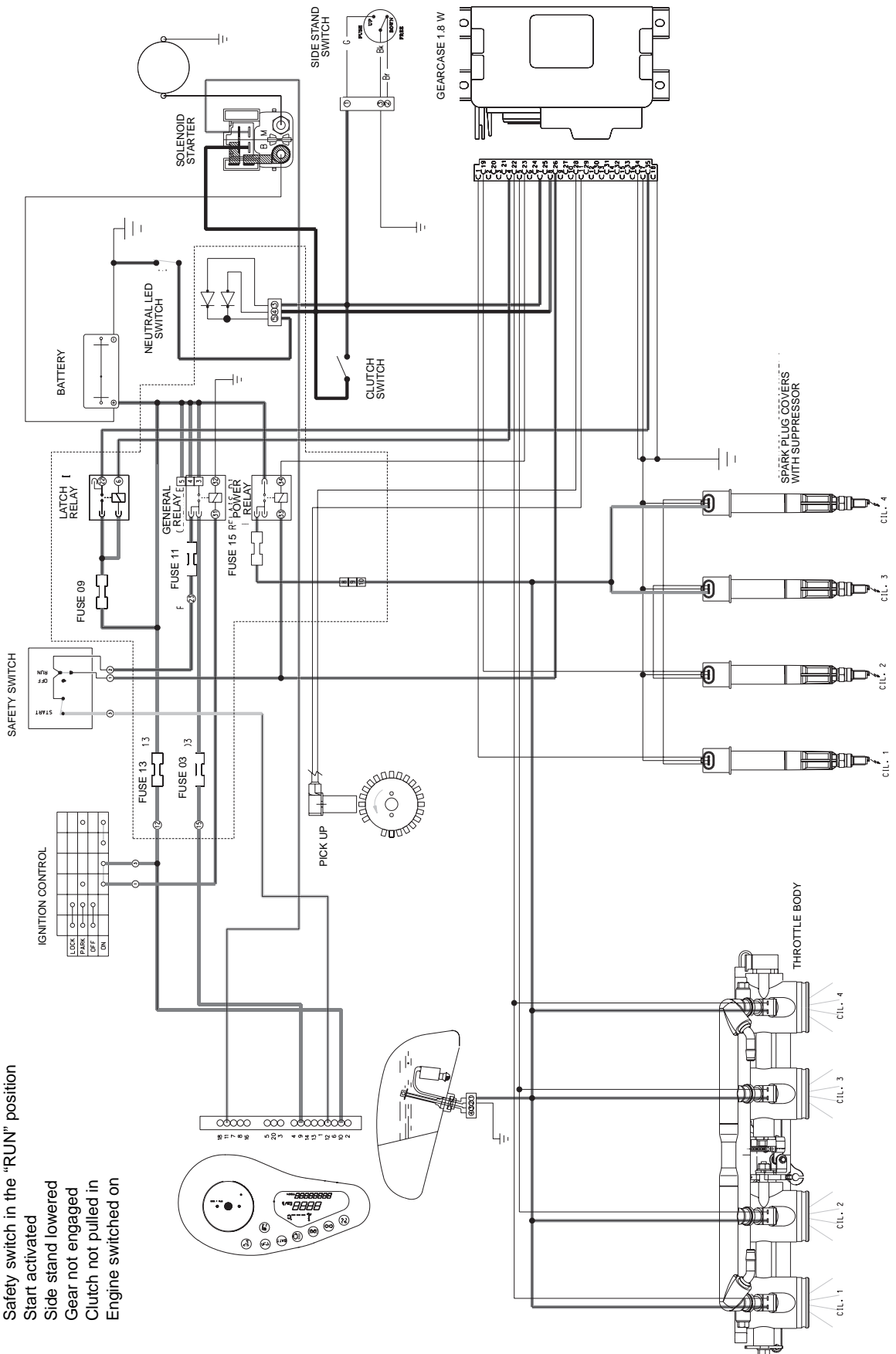



Electrical system

FUSES

The fuses are situated on the right side of the motorcycle.

To reach them it is necessary to remove the tank side panel and the cover.



Substitute the burnt fuse and replace the cover (find the electrical fault before replacing the fuse).

To identify the position and the function of the fuses, consult the information written on the adhesive and in the electrical diagram. The reference letters indicated in the figure correspond to those shown in the diagram.



STARTER MOTOR REMOVAL

- Remove the fuel tank (see chapter C "Bodywork").
- Drain off the engine coolant, completely emptying the cylinder passageways via the two screws situated on the front part of the cylinders.
- Remove the coils from the frame support.
- Remove the blow-by cover.
- Disconnect the cable of the pick-up.
- Disconnect the alternator connector.
- Remove the coolant liquid pump by disconnecting the rubber union from the conduit that brings the coolant liquid to the cylinders.
- Remove the conduit of the cylinder cooling system.
- Disconnect the cable of the starter motor.
- Remove the two fixing screws of the starter motor.
- Remove the starter motor by extracting it as indicated in the figure.

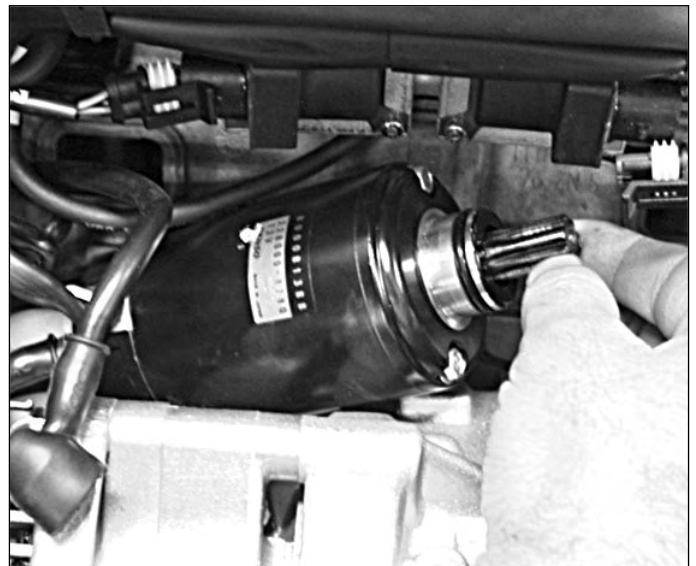



Electrical system

STARTER MOTOR CHECK

If a fault has been diagnosed in the starter motor, it is necessary to proceed as follows with the check:

- Connect a tester between earth and the starter motor terminal.
- Check that there is continuity between the positive pole and the engine earth. If there is no continuity, substitute the starter motor.



E

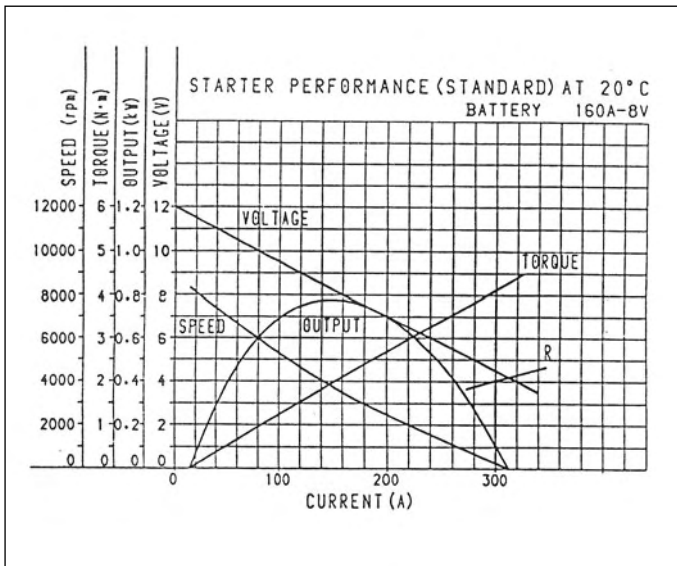

STARTER MOTOR ASSEMBLY

Assemble the starter motor in the reverse order of removal. Pay attention to the following points:

Substitute the O-ring with a new one to avoid oil leakage and the ingress of humidity.

- Apply grease to the oil seal lip.
- Apply a small quantity of MOLYKOTE to the rotor shaft.
- Apply a small quantity of LOCTITE 243 to the bolts of the starter motor.

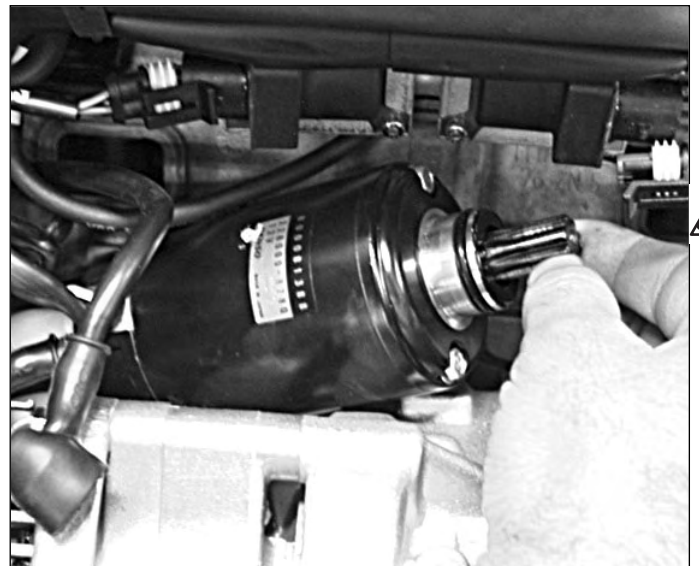



Electrical system

Starter relay check

Remove the rider seat, disconnect the battery.
Unhook the connector from the starter relay.

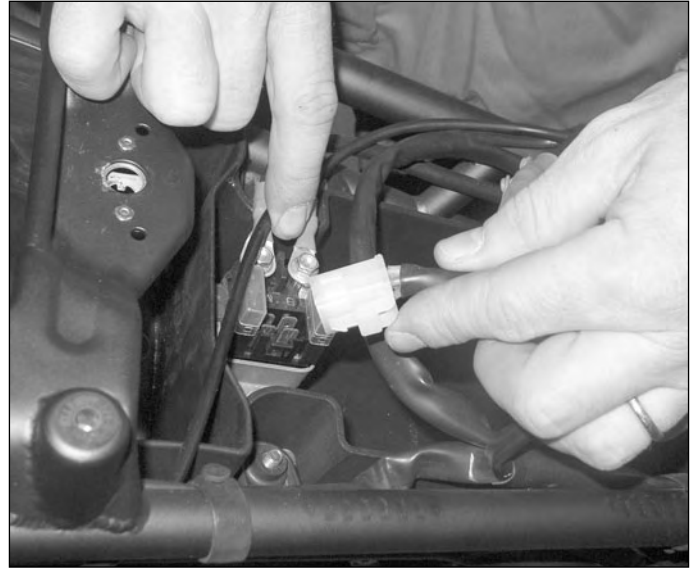

Unscrew the fixing screw of the relay.

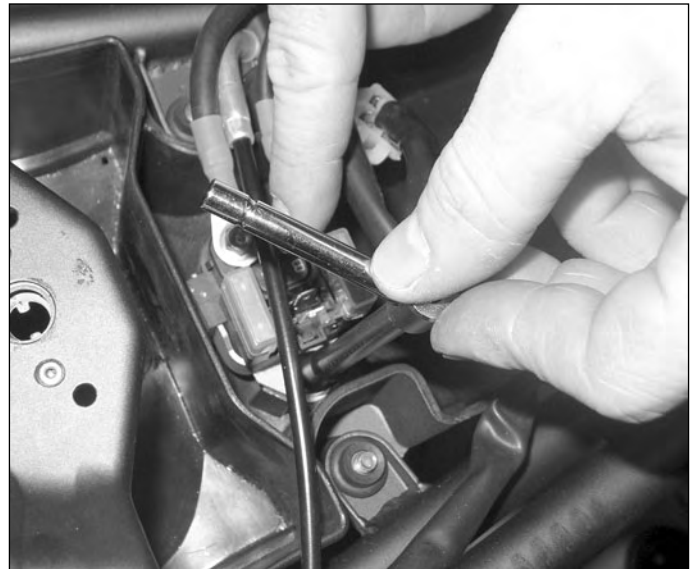

Disconnect the cables of the starter motor and the positive cable of the battery from the relay.





Electrical system

Apply 12 volts to the terminals (1) and (2) of the relay and check the continuity between terminals B-M.

Do not apply the battery voltage to the starter relay for more than five seconds to avoid overheating and therefore damaging the winding.

- Using a multi-tester, check that the winding is on open circuit or if a resistance is present. The winding is in good condition if the value of the resistance revealed is as indicated.

Starter relay resistance
Standard: 3-6 ohm

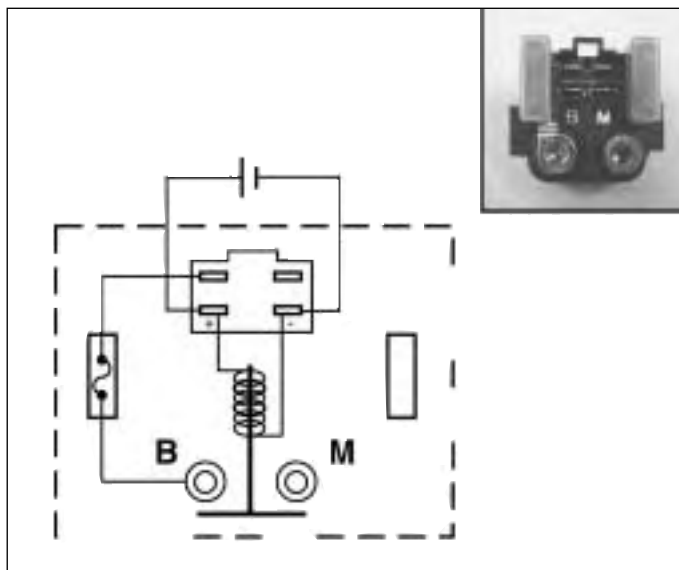

IGNITION/SIDE STAND SAFETY SYSTEM PARTS CHECK

The safety system of the motorcycle is included into the CPU.

Terminals 3, 4 and 5 of the 36-way coupling of CPU are those involved.



Using a multi-tester, measure the voltage between the terminals as indicated in the following table:

	3	4	5
3			
4			
5	0,4-0,6	0,4-0,6	

12	11	10	9	8	7	6	5	4	3	2	1	
	24	23	22	21	20	19	18	17	16	15	14	13
36	35	34	33	32	31	30	29	28	27	26	25	



Electrical system

GEARCHANGE POSITION SWITCH

The connector of the gearchange position switch is placed in the proximity of the side stand and motorcycle speed sensor connectors.

The connector of the gearchange position switch differs from the side stand connector since it is identified by an S marked on the electric system sheathing. Disconnect the connector of the gearchange position switch and utilising a multi-tester, check the continuity between the black lead and earth with the gears in neutral.

	Black	Engine earth
ON (Neutral)	○—	—○
OFF (Neutral exluded)		



 **When the connector of the gearchange position switch is connected and disconnected, be sure to turn the ignition switch to the "OFF" position to avoid damaging the electronic parts.**



SIDE STAND SWITCH

The connector for the lateral stand switch is mounted on a support under the pinion wheel transmission casing on the left side of the motorcycle.

- Disconnect the connector of the side stand switch. Utilising a multi-tester, check the continuity as indicated in the table.

	Green	Brown	Black
ON (Raised)	○—		—○
OFF (Lowered)		○—	—○

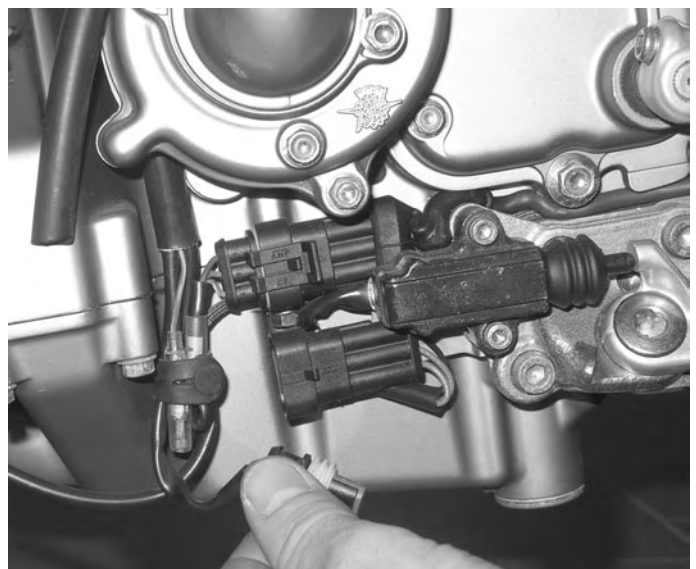



Electrical system

If it is necessary to substitute the switch proceed by unscrewing the two fixing screws.

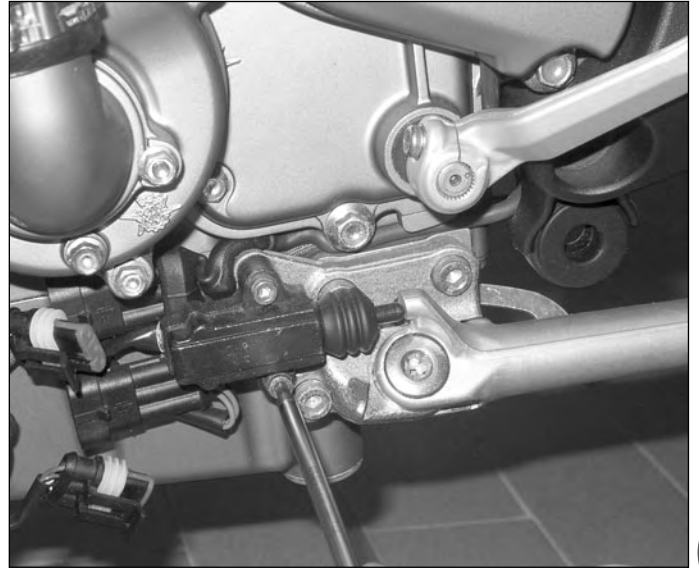

SPARK PLUGS

To accede to the ignition spark plugs, it is necessary to remove the following components:

- Tail unit
- Left side panel
- Right side panel
- Fuel tank
- Air filter compartment

Remove the coil connectors.

To carry out this operation, free the secondary lock (yellow "tongue") removing it from its seat, then press the black "tongue" and unhook the connector.



Unscrew the earth connection from the cylinder head cover and free the coil wiring from the frame removing the two fixing band fasteners; then slide the wiring out from the right side.



E



Electrical system

Unscrew the fixing screws of the coil plates and remove them.
Remove the coils from their seats.

 **When reassembling the coils, take care to connect the map connector correctly. If not connected or if connected incorrectly, it could cause damages to the coils themselves.**



Check the resistance between the electrode and the screw cap of the spark plug as shown in the figure.

Permitted resistance: 4.5 ÷ 5.5 K

Carry out the test on all the spark plugs.



RUN OFF SAFETY SWITCH

Remove the instrument panel cover unscrewing the two fixing screws on the sides.





Electrical system

Remove the relative connector to the right hand control group as indicated in the figure.

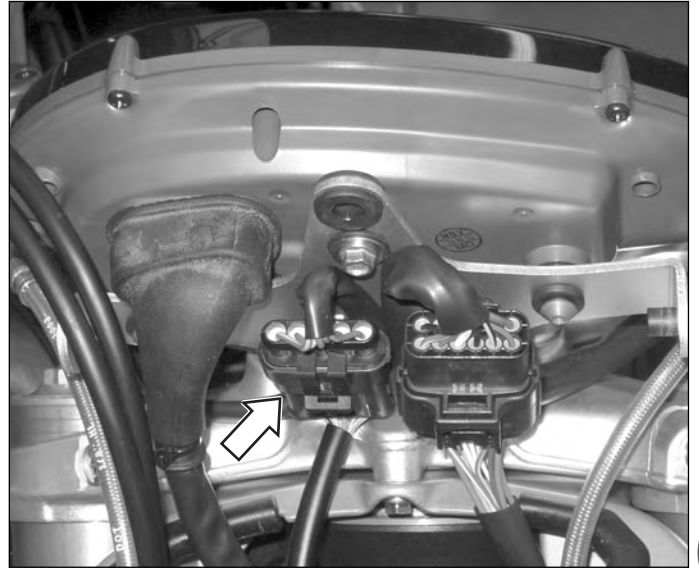

Remove the plug part of the connector.

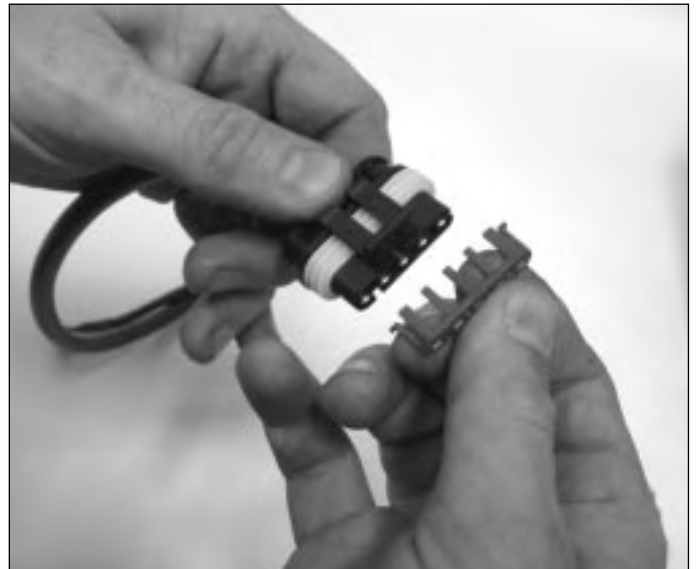

With the switch in the "RUN" position, check the continuity between pins (1) and (2).

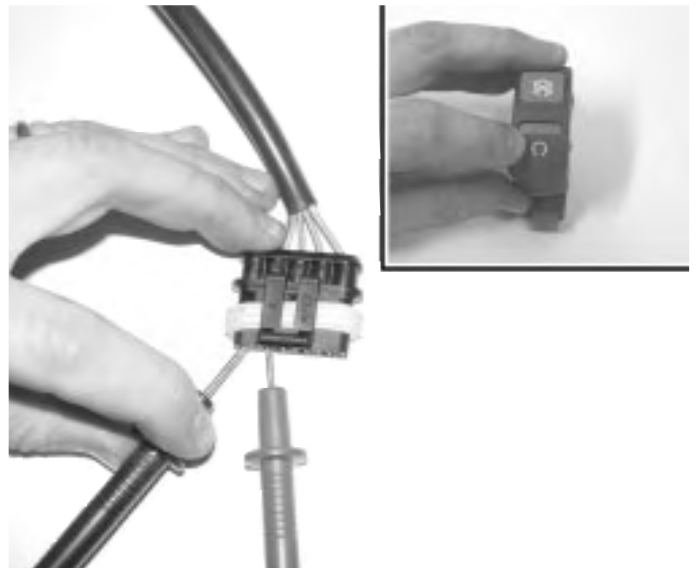



Impianto elettrico

INSTRUMENTATION

If faults are found in the instrumentation, it is necessary to check the main wiring and the various components related to the instrumentation.

To carry out the various checks, remove the instrument panel cover, then move aside the rubber cap and the connector situated behind the instrumentation.



Consult the diagram below to identify the contacts of the various components:

1 Side stand	11 Starter relay output
2 Oil press	12 Engine starter switch
3 High beam	13 Turn-L
4 Lights	14 Turn-R
5 Neutral	15 Open
6 Low fuel	16 Ta pulse
7 CHG	17 Open
8 Temp sensor	18 Sp pulse
9 IGN	19 Open
10 Battery	20 GND

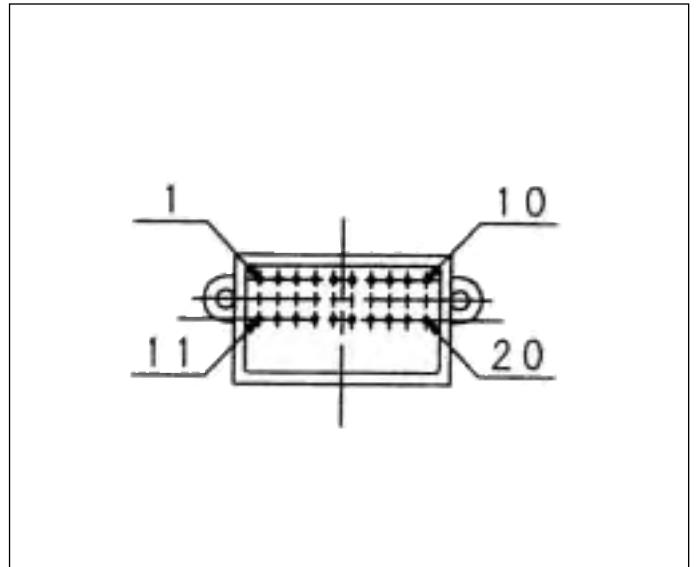

OIL PRESSURE SENSOR

With the engine switched off, it is necessary to find continuity between the terminal of the sensor and the earth of the motorcycle (as shown in the figure).

With the engine switched on, the contact must be open.

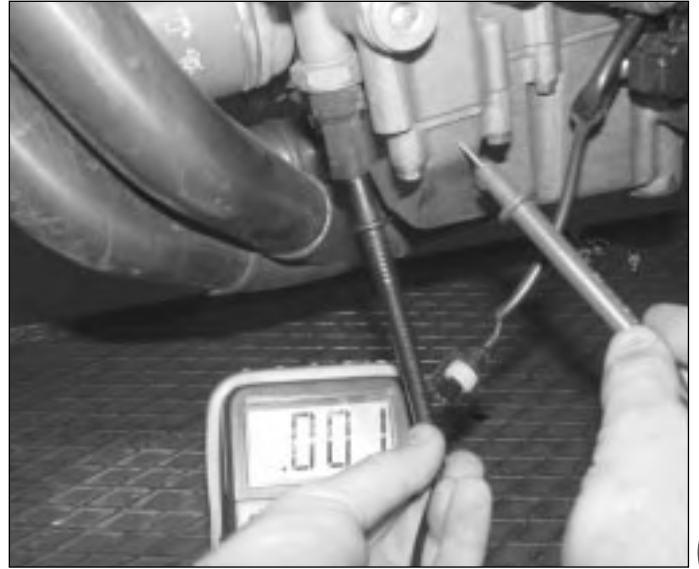

E

FUEL LEVEL WARNING LIGHT CHECK SWITCH

After verified the fault in the fuel level warning system, check in the fuse box on the right side of the motorcycle the good condition of the relative fuse.

Having ascertained the good condition of the fuses in question, proceed as follows:

With the fuel tank removed from the motorcycle and empty of fuel, connect a small circuit composed of 12V battery and a light bulb of 12V – 1.7W to the connector of the fuel level indicator as shown in the diagram.

If the switch is in a good condition, the light bulb should light up after several seconds.

Pour some fuel into the fuel tank and confirm that the light bulb switches off after having poured more fuel into the tank than the maximum required for the reserve.

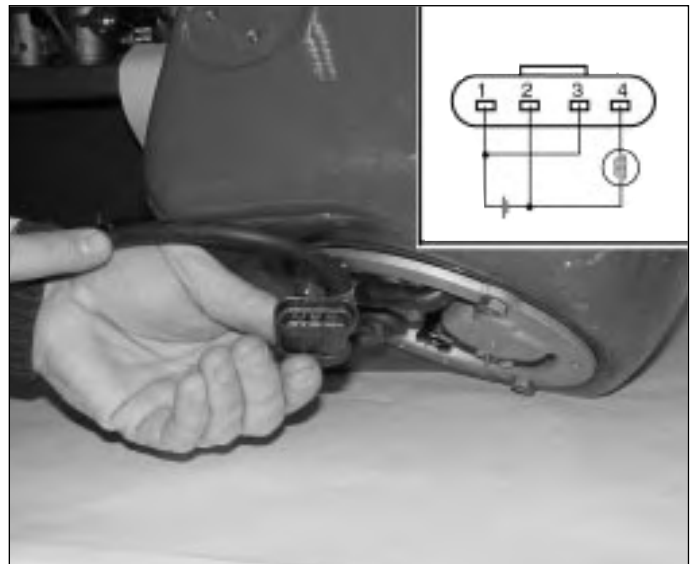



Electrical system

INSTRUMENT PANEL WATER SENSOR

Connect a resistance between the two connections of the connector as shown in the table. Turn the ignition key to the "ON" position.

At this point the display should indicate the Temperature relative to the resistance applied.

It is sufficient to carry out the test at 50° C and at 100° C with the respective resistances of 1.150 kOhm. and 0.204 kOhm.

TEMP. °C	RESIST. kΩ	TEMP. °C	RESIST. kΩ
- 40	100.950	+ 40	1.598
- 30	53.100	+ 50	1.150
- 20	29.121	+ 60	0.746
- 10	16.599	+ 70	0.565
0	9.750	+ 80	0.377
+ 10	5.970	+ 90	0.275
+ 20	3.747	+ 100	0.204
+ 25	3.000	+ 110	0.153
+ 30	2.547	+ 125	0.102



KEY IGNITION SWITCH

If there is no 12V input between pin (9) and (20) of the instrument panel connector with ignition switch in the "ON" position, the cause can be identified by a fault in fuses 13 or 3.

If the fuses are in good condition, check the continuity between the pin (9) of the instrument panel and the pin (15) of the fuse box connector and between the pin (10) of the instrument panel and the pin (12) of the fuse box connector.



STARTER RELAY ACTIVATION

- Check that there is a 12V input between pin (11) and (20) with the safety switch in the "RUN" position and the starter button pressed.

- If there is no voltage, check the presence of voltage input between pin (12) and (20).

- If there is no voltage input between pin (12) and (20), check the condition of fuse E5 after which check the right hand control as follows:

- 1) Disconnect the connector of the right hand control;
- 2) Check the continuity between the contacts (1) and (3) with the safety switch in the "RUN" Position and the starter button pressed.
- 3) Having verified the good functioning of the right hand control, the cause can be identified as damage to the instrument panel.





LEFT DIRECTION INDICATOR

If the left direction indicator warning light does not function, there must be the presence of voltage input intermittently between pin (13) and pin (20).

If the presence of input voltage is verified, the continuity between pin (13) of the instrument panel and pin (5) of the left hand control connector must be checked.

RIGHT DIRECTION INDICATOR

If the right direction indicator warning light does not function, there must be the presence of voltage input intermittently between pin (14) and pin (20).

If the presence of input voltage is verified, the continuity between pin (14) of the instrument panel and pin (7) of the right hand control connector must be checked.

RPM INDICATOR

If the r.p.m. of the engine is not signalled on the instrument panel with the engine switched on, check:

- . The continuity between pin (16) of the instrument panel and pin (20) of the CPU.
- . If the cause is verified, the fault will be found in the CPU.

N.B.

In the case of substitution of the CPU: with the ignition key in the "OFF" position wait approximately fifteen seconds before disconnecting the same.

SPEED SENSOR

If the speed of the motorcycle is not indicated on the instrument panel, proceed as follows:

- Check the condition of the fuse 3.

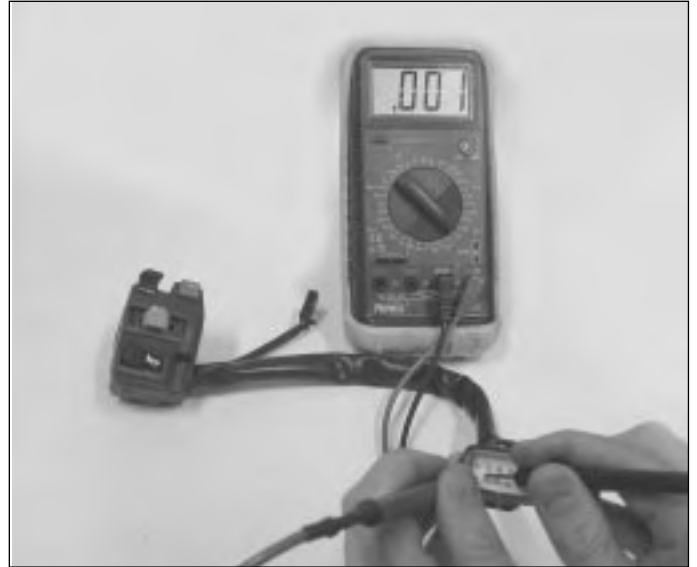

E

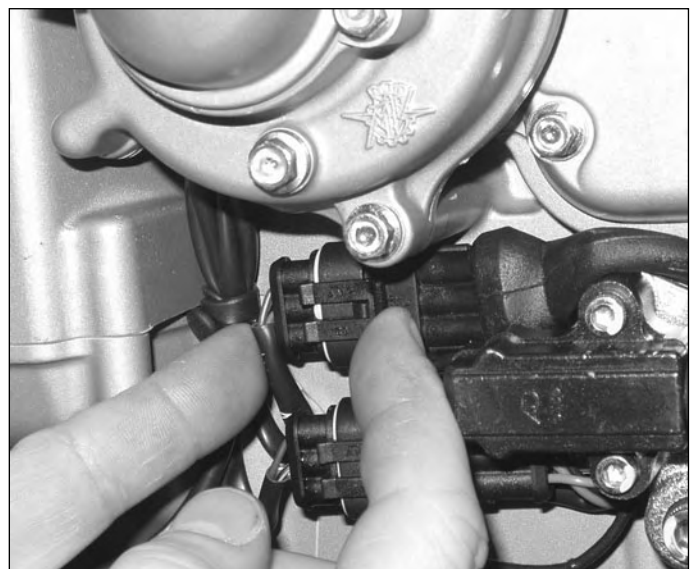



Electrical system

If the fuse in question is in good condition, proceed with the check of the speed sensor as follows:

- 1) Remove the sensor from the motorcycle as described in the "F4 workshop engine manual (Code 8000A1592).
- 2) Disconnect the connector, check that there 10 k Ω is measured between terminals (1) and (2) of the connector.

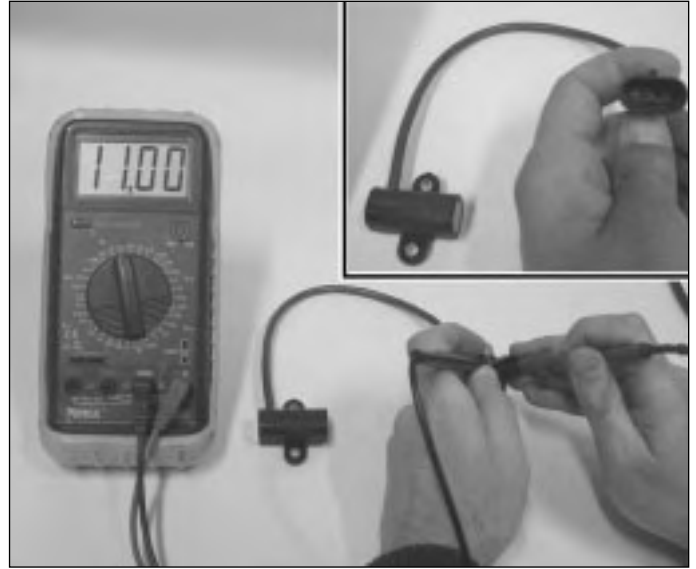

COOLING FAN SYSTEM

If there is a fault in the functioning of the cooling fan, proceed with the following check:

- Check the condition of fuse 7;
- If the fuse is in good condition, check the cooling fan relay mounted on the right side of the motorcycle as indicated in page 38.

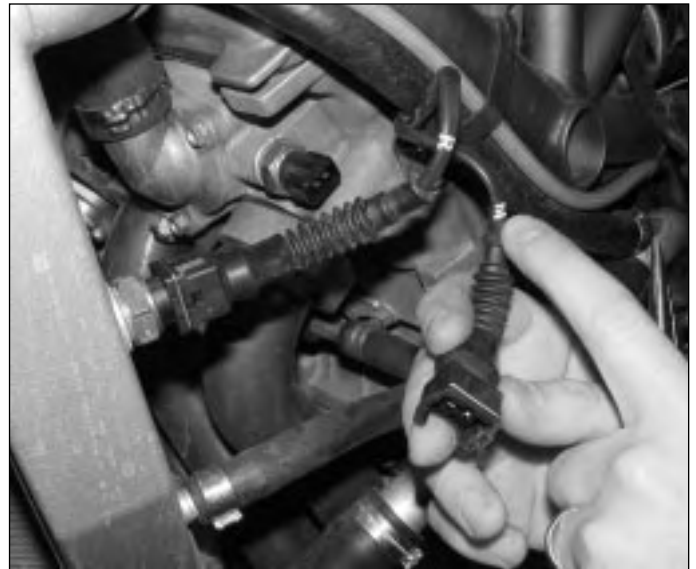

If the relay is in good condition but does not become excited, disconnect the connector of the temperature sensor marked by an M on the lead. Make a bridge between the two contacts as shown in the figure.

. With the ignition switch in the "ON" position the fan should operate and the voltage at the Yellow-Black/White lead of the fan relay connector should be 12V.

. Check the continuity of the system.

. Check the condition of the thermal switch on the radiator. The functioning interval is as described in chapter "Cooling system".

100° C

97° C





Electrical system

KLAXON

A fault in the klaxon system should be checked at various points:

- . Check the condition of fuse 11 in the fuse box on the right side of the motorcycle.
- . If the fuse is in good condition, disconnect the connector of the left control and check the continuity between contact 34 of the control with the klaxon button pressed as in the following page under "Switches".
- . Check the continuity of the winding of the klaxon.



E



Electrical system

SWITCHES

Check the continuity of each switch with a tester. If there is any anomaly, substitute the respective switch unit with a new one.

START SWITCH				ENGINE STOP SWITCH			
	G/O	Y/R	TENS. NOM. Nom. voltage		Y/R	Gr/R	TENS. NOM. Nom. voltage
OFF							
ON			12V				12V
CURRENT LOAD 3 A				CURRENT LOAD = = 0.5 A MAX			
FUNCTIONING FORCE 5 N ± 3 N				FUNCTIONING FORCE 8 N ± 3 N			

LIGHTING SWITCH						FLASHER SWITCH				HORN SWITCH				
1		2					Lb	Bk/B	R/Bk	CARICO NOMINALE Rated load		Gr	B	CARICO NOMINALE Rated load
	Y/Bk	Y/R	Y/Bk	Y/R	G/R	R/G				52 W	A RIPOSO (Off)			
							N	PREMUTO (OFF)			PREMUTO (On)			60 W
										52 W	FORZA D'AZIONAMENTO Functioning force			
CARICO NOMINALE-Rated load • = 0 W = 30 W = 30+4 W						FORZA D'AZIONAMENTO-Functioning force 12 ± 3N				FORZA D'AZIONAMENTO Functioning force 7 ± 3N				
FORZA D'AZIONAMENTO-Functioning force da definire						DIMMER SWITCH				PASSING-LAP SWITCH				
		W	R/G	Bk					CARICO NOMINALE Rated load		W	G/R	CARICO NOMINALE Rated load	
									4 W	A RIPOSO (Off)				
									4 W	PREMUTO (On)			4 W	
FORZA D'AZIONAMENTO Functioning force 8 ± 3N						FORZA D'AZIONAMENTO Functioning force 5 ± 3N								

FLASHER SWITCH					HORN SWITCH			
	Lb	Bk/B	R/Bk	CARICO NOMINALE Rated load		Gr	B	CARICO NOMINALE Rated load
				52 W	A RIPOSO (Off)			
N	PREMUTO (OFF)				PREMUTO (On)			60 W
				52 W	FORZA D'AZIONAMENTO Functioning force			
FORZA D'AZIONAMENTO-Functioning force 12 ± 3N					FORZA D'AZIONAMENTO Functioning force 7 ± 3N			
DIMMER SWITCH					PASSING-LAP SWITCH			
	W	R/G	Bk	CARICO NOMINALE Rated load		W	G/R	CARICO NOMINALE Rated load
				4 W	A RIPOSO (Off)			
				4 W	PREMUTO (On)			4 W
FORZA D'AZIONAMENTO Functioning force 8 ± 3N					FORZA D'AZIONAMENTO Functioning force 5 ± 3N			



Suspension and wheels

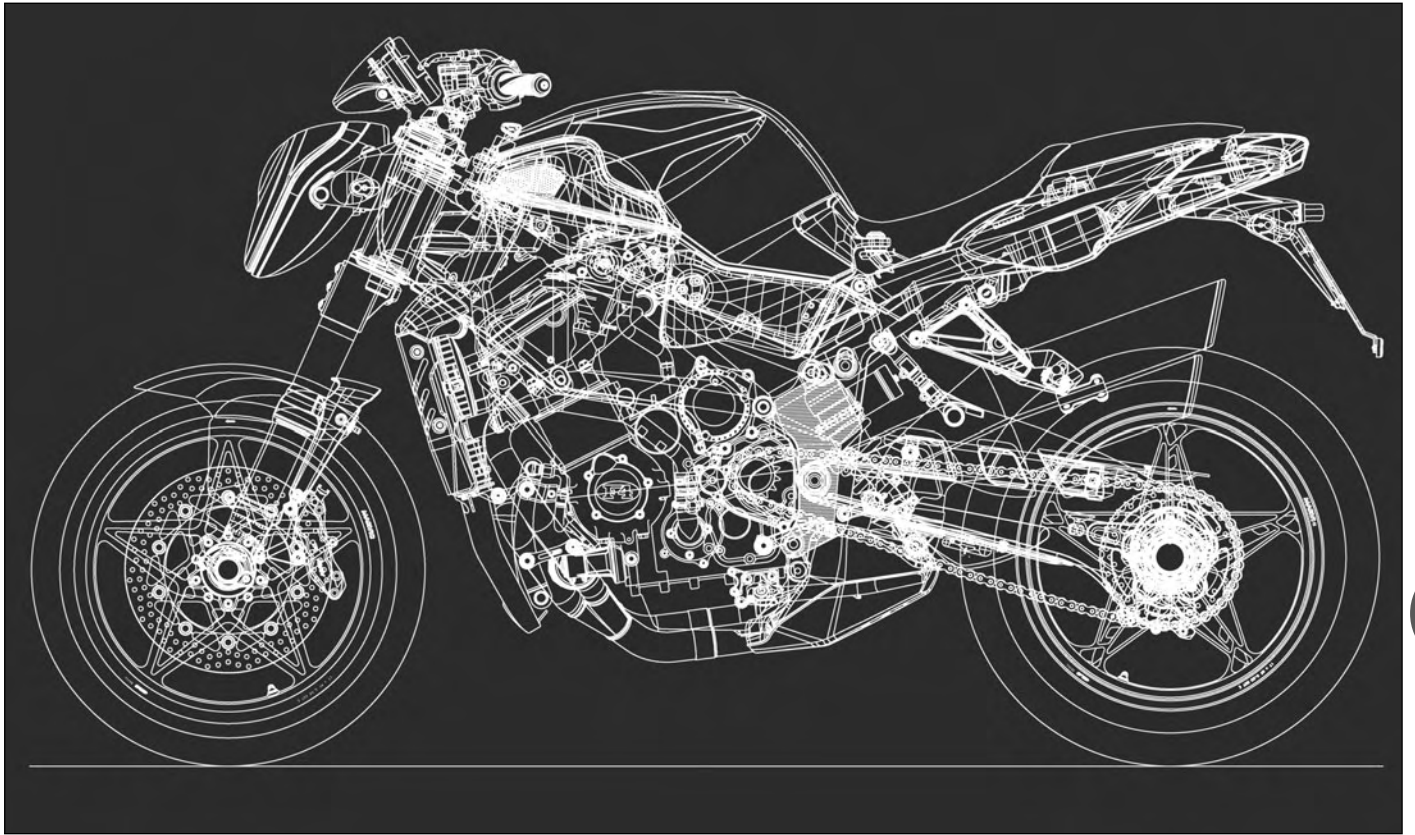

F

SECTION F

Revision 0



SUMMARY

FRONT WHEEL	PAGE 3
FRONT WHEEL REMOVAL.....	PAGE 4
FRONT FORK.....	PAGE 10
FRONT FORK OVERHAUL	PAGE 11
STEERING ASSEMBLY	PAGE 23
STEERING ASSEMBLY OVERHAUL	PAGE 24
REAR SUSPENSION AND FORK	PAGE 29
MONO-ARM FORK REMOVAL AND OVERHAUL	PAGE 36
REAR WHEEL HUB	PAGE 44
REAR WHEEL REMOVAL	PAGE 45
MOTORCYCLE SET-UP ADJUSTMENT	PAGE 58
WHEEL BALANCE CHECK	PAGE 62

F

FRONT WHEEL

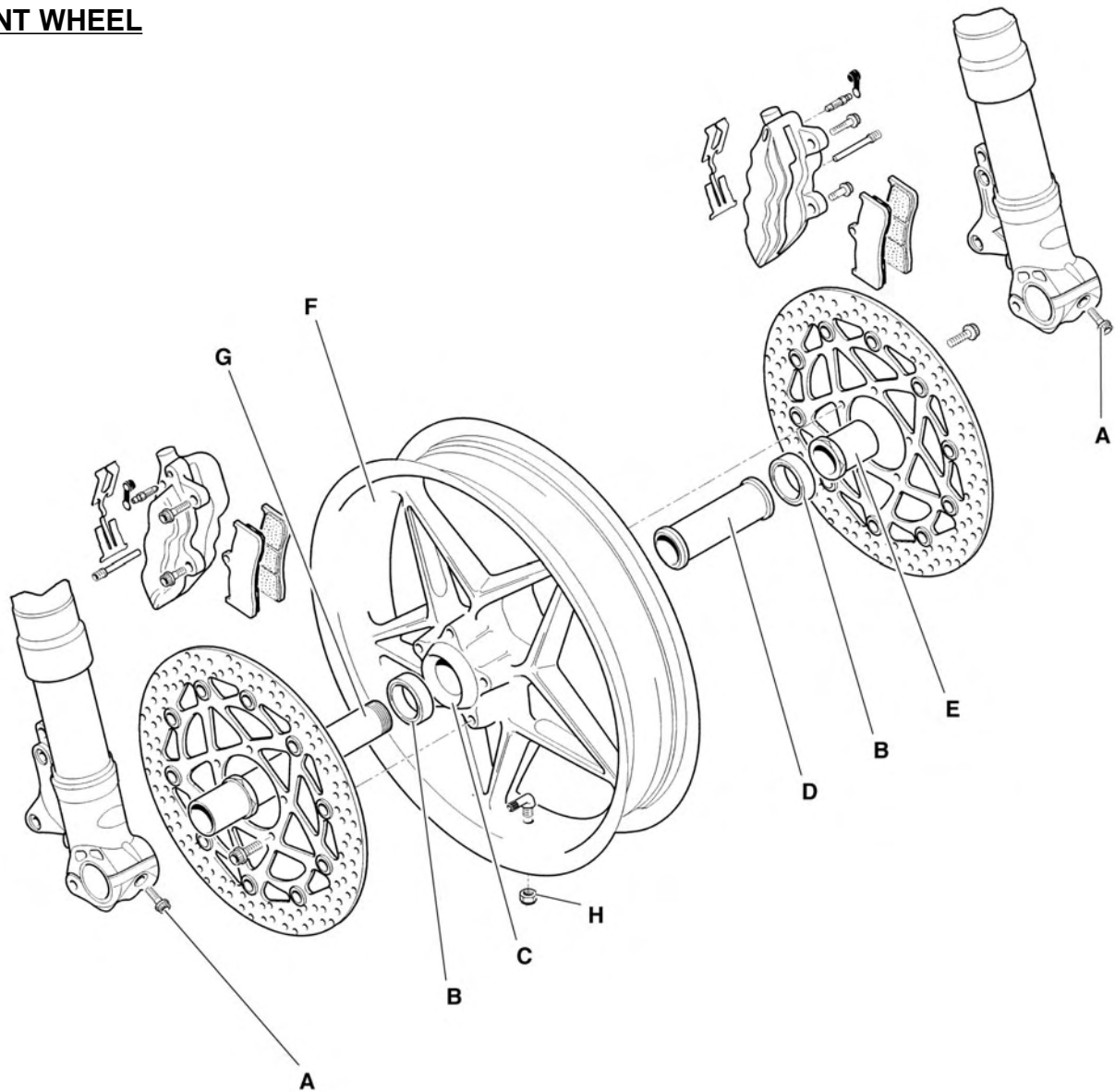

	A	B	C	D	E	F	G	H			
Torque pressure	N-m	20 ÷ 22			40 ÷ 44			5 ÷ 7			
	Kg-m										
	ft-lb										
Operation											

Description	BRUTALE ORO	BRUTALE S
FRONT WHEEL		
Material	Magnesium alloy	Aluminium alloy
Dimensions	3.50" x 17"	3.50" x 17"
FRONT TYRE		
Dimensions	120/65-ZR 17 (56 W)	
Brand and type	DUNLOP - Sport Max D 207 Race Replica	PIRELLI - Dragon Evo MTR21 Corsa PIRELLI - Diablo Corsa MICHELIN - Pilot Sport MICHELIN - Pilot Power DUNLOP - Sport Max D 207 Race Replica
Front tyre pressure (*)	2.3 bar (33 psi)	2.3 bar (33 psi)

*: When using tyres of a brand which is different from the recommended type, refer to the tyre pressure marked by the manufacturer on the side of the tyre.



Suspension and wheels

Before proceeding with the removal and overhaul of the components relative to the front suspension, it is advisable to remove beforehand the front mudguard as described in detail in chapter H "Brakes".
Place the motorcycle on the rear stand.

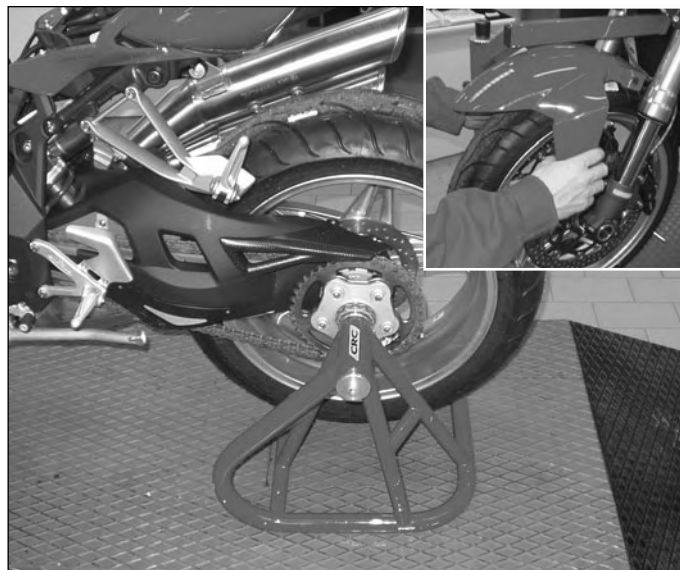

Special tool: N. 800092642

F FRONT WHEEL REMOVAL

Front brake caliper removal

Unscrew the two fixing screws (1) of both front calipers and remove the calipers.

N.B. Position the removed calipers so that they do not hamper subsequent operations.



Protect the disassembled calipers with protective material thereby avoiding possible damage to the wheel rim. Hold the calipers appropriately, to not charge the brake tubes. Pay attention to not bend the brake tubes to avoid any damages.



Lift the motorcycle up at the front end.
Mount the special tool that is supplied with a pin on the lower part of the steering base as shown in the figure.
Lift the motorcycle up.



Special tool N. 800095807 and N. 800095808

N.B. To facilitate the removal of the wheel it is advisable to tape the brake tubing to the special tool.





Suspension and wheels

Remove the screw (1) on both front wheel/fork attachments.



During this operation, it is necessary to support the wheel.

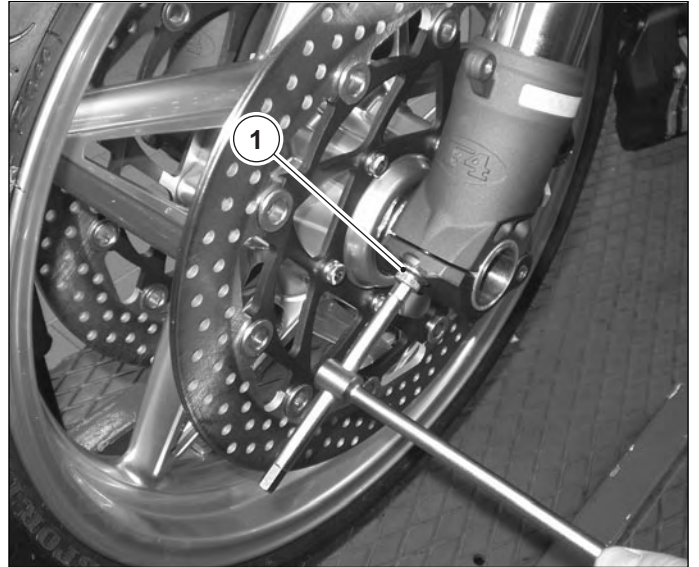

Front wheel bearing check

With the wheel spindle still mounted to the wheel, rotate the wheel to check that the bearings are not pitted and rotate with a smooth action. Check also for axial (A) and/or radial (B) movement. If either condition is verified, substitute the bearings.

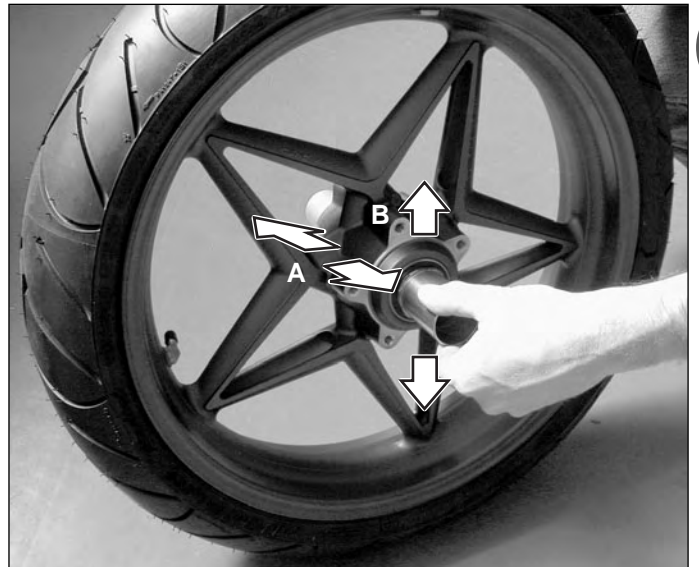

F

Front wheel bearing substitution

Remove the wheel spindle utilising the special tool as shown in the figure.



Special tool N.800092872

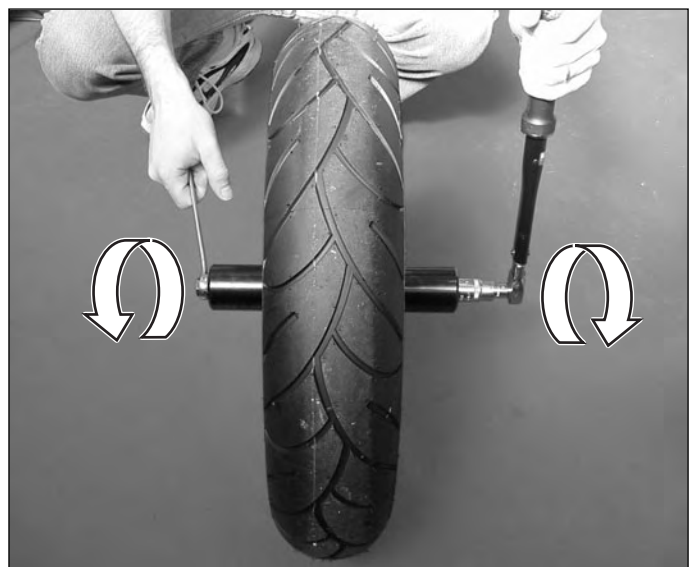



Suspension and wheels

Utilise the special tool to extract the bearings. To assemble the tool, it is necessary to remove the screw (1) and extract the wheel spindle (2); remove the nut (3) and the flange (4).



Before substituting the bearings as indicated above it is advisable to remove the brake discs as indicated in chapter "Brakes" to avoid damaging them.



Special tool N. 800092862

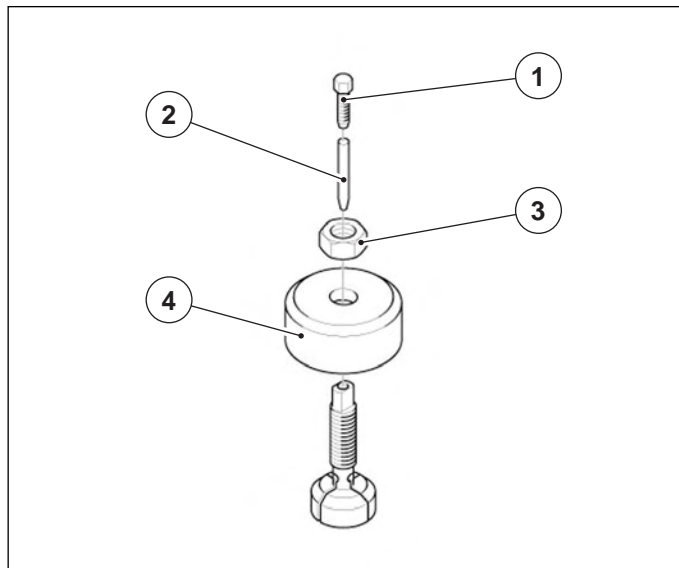

F

Introduce the extractor until the internal ring of the bearing is hooked up. Introduce the wheel spindle and screw and **manually block them**.



Mount the flange, spacer ring and nut utilising a **14 mm** spanner and a **27 mm** spanner and extract the bearing as shown in the figure.

N.B. Operate in the same way on both bearings.





Suspension and wheels

Check that the ends of the aluminium spacer and the seats of the bearings on the wheels are not scored or marked.



Reassembly – front wheel bearings

Before proceeding with the reassembly, accurately clean the bearing seats in the wheel hub. Mount a bearing onto the special tool.



Special tool N. 800092868

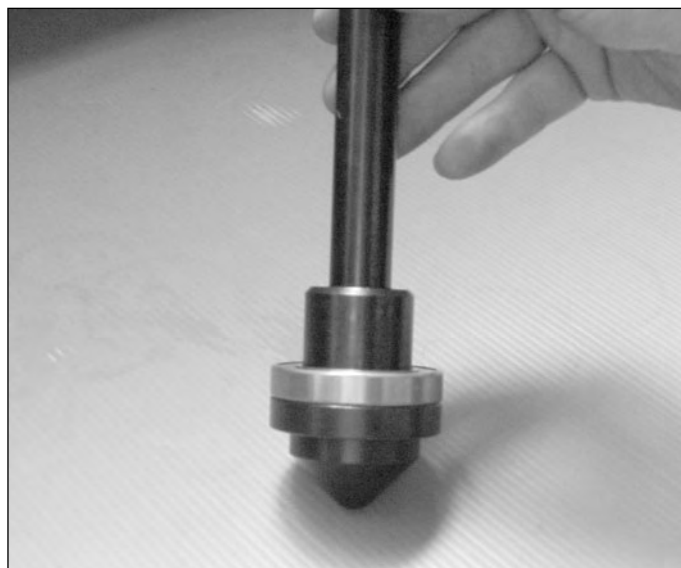

F

Introduce the stem of the tool into the wheel hub as shown in the figure and insert the aluminium spacer.



Assemble the other bearing and the guide.

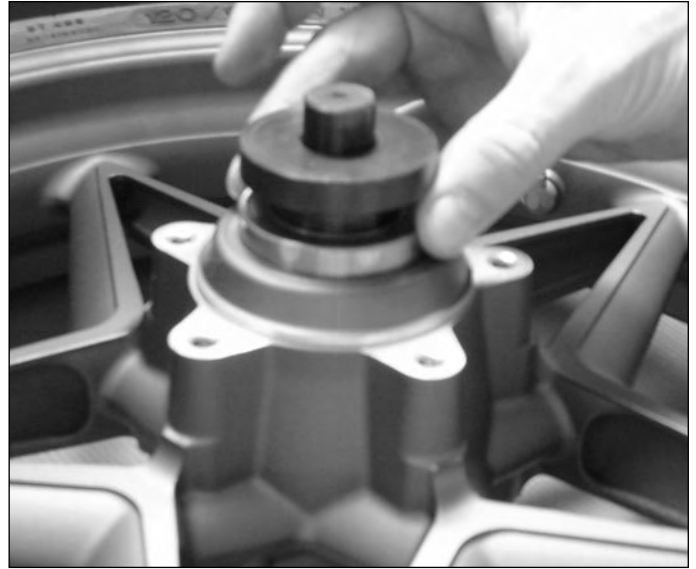

F Insert the guide spacer and utilising a press, squeeze down the bearings.

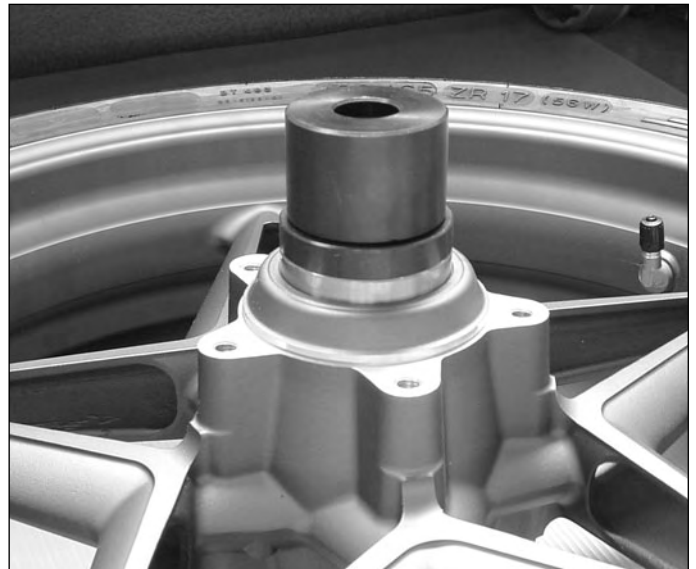

Proceed as illustrated in the figure.

 **Attention: the wheel bearings should be mounted with little interference but should the action of the press be blocked in any way, release the press.**

Having completed the assembly, check that the aluminium spacer does not have axial play. Assemble the wheel spindle and carry out again the rolling check by rotating the wheel.



Wheel spindle check

Place the wheel spindle on two v-prisms on a flat surface.



Utilising a dial gauge, check that the **eccentricity in the central part does not exceed 0.05 mm.**

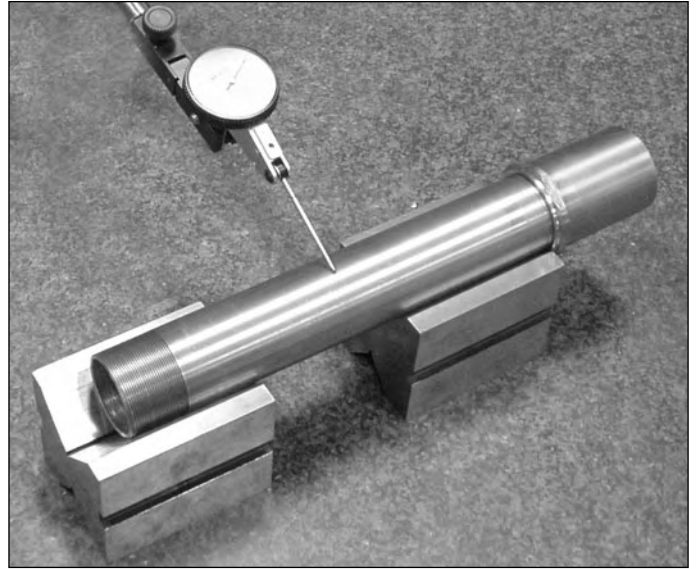

Wheel assembly



If the front tyre is substituted, before assembling the wheel it is necessary to balance the wheel following the indications in page 62.

After having carried out the check on the parts of the front wheel, accurately clean the wheel spindle and assemble it from right to left. Tighten the screw ring of the wheel spindle to the torque prescribed utilising the special tool. Ensure that when the wheel is mounted into place, the screw ring of the wheel spindle must be on the left side of the motorcycle.



Screw ring of the frontal wheel spindle - Torque pressure: 40 ÷ 44 N•m



Special tool N. 800092872



F

Mount the wheel, complete with wheel spindle onto the wheel attachments of the front forks.



Ensure that the attachments do not sit on the external face of the hexagon.

Tighten the two screws to the torque pressure prescribed.

Mount the two brake calipers as described in chapter H "Brakes".



Tightening torque of the fork attachment fixing screws: 20 ÷ 22 N•m



During this phase it is necessary to support the front wheel to avoid snagging the two screws.

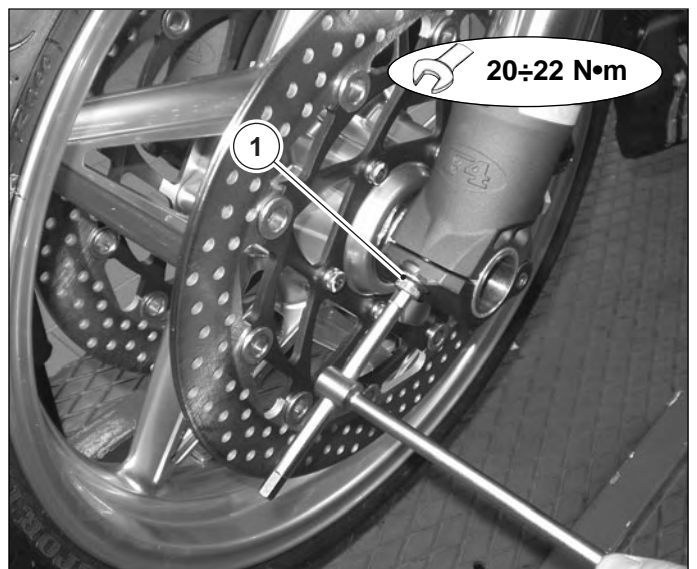

FRONT FORK

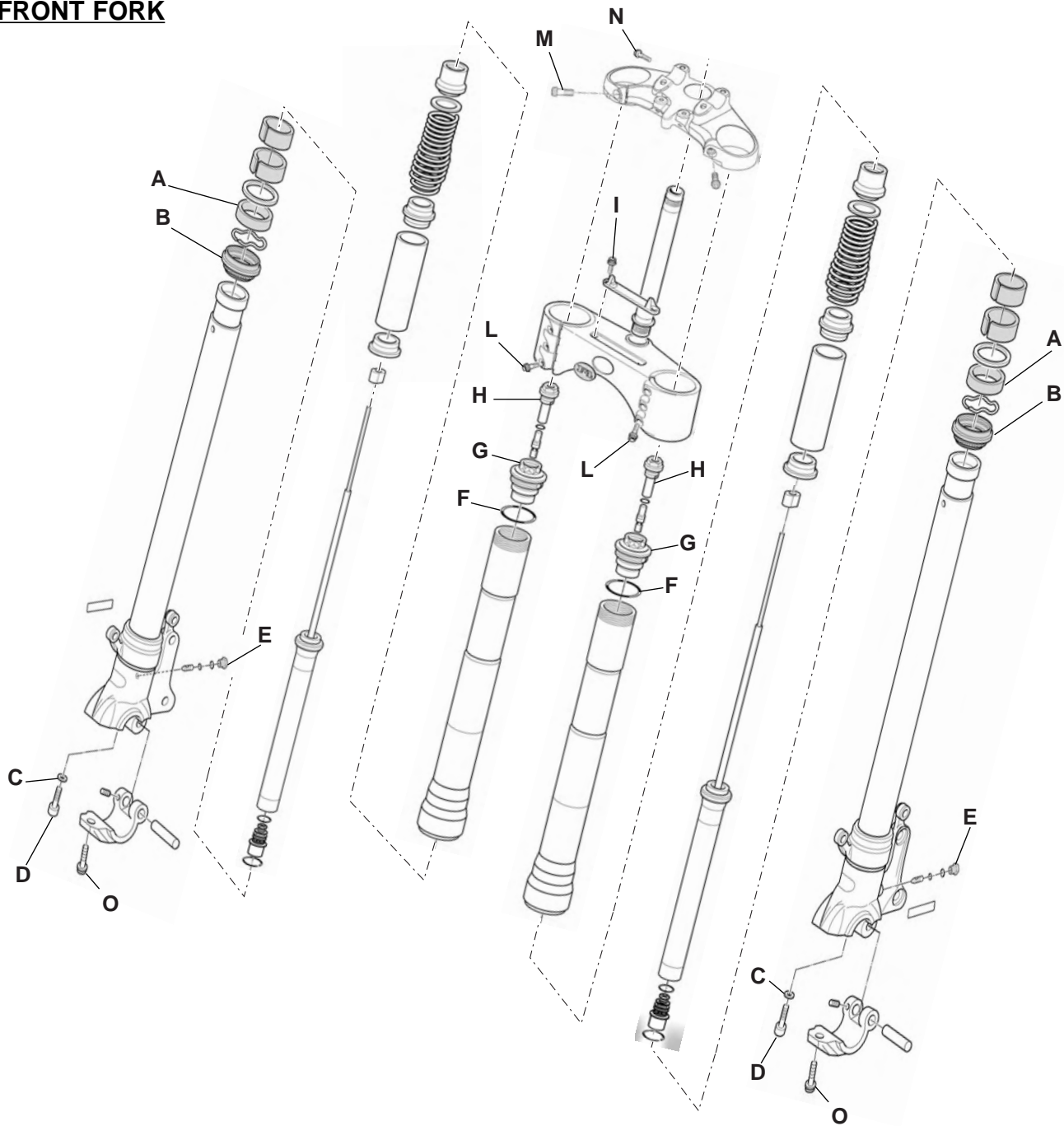

		A	B	C	D	E	F	G	H	I	L	M	N	O
Torque pressure	N-m				40	20		20	20	8 ÷ 10	8 ÷ 9	16 ÷ 18	22 ÷ 24	20÷22
	Kg-m													
	ft-lb													
Operation														

Description	Brutale ORO	Brutale S
FRONT SUSPENSION		
Type	Hydraulic telescopic forks with the stems positioned upside down, equipped with a system of external adjustment for extension, compression and spring preload	
Ø stems (mm)	50 with Titanium Nitride treatment	50
Telescopic movement	128	128



Suspension and wheels

FRONT FORK OVERHAUL

Remove the front wheel as described in the paragraph "Front wheel removal" of this Chapter.



Stem removal

Slacken the screw (1) of the steering head and the three screws (2) of the steering base.

During this phase, support the stem.

Slide out the stem, supporting it with both hands and operating with caution so as not to drop it.

Proceed with the same operation for both stems.

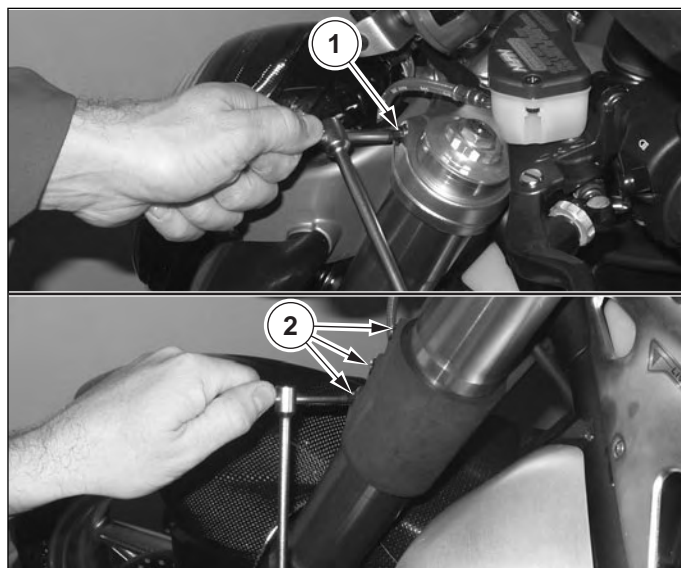

Fork overhaul

Place the stem in a vice paying attention to protect the surfaces to not damage them.





Suspension and wheels

Slacken the fork cap (1).

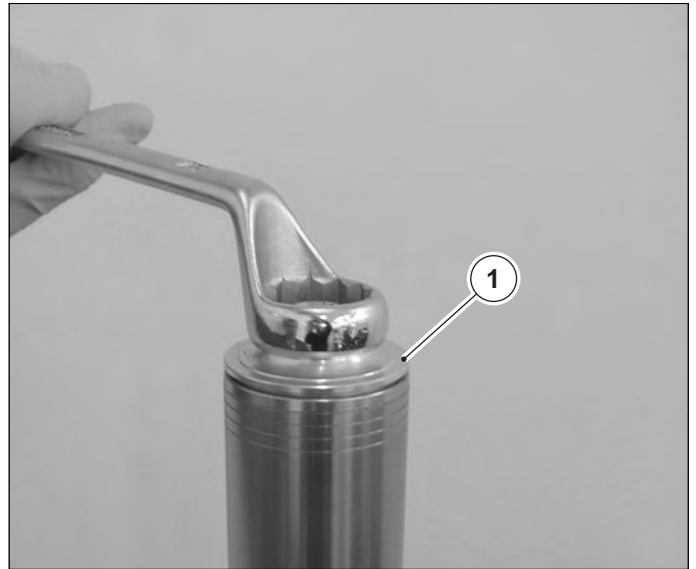

F

Completely unscrew the cap and lower the sleeve as shown in the figure. This operation must be carried out keeping the stem in a vertical position.



Unscrew the cap. Using the key, adjust the spring preload adjuster while blocking the rotation of the nut placed on the pump rod.





Suspension and wheels

Remove the spring-push spacer (1) and the relative spacer ring.

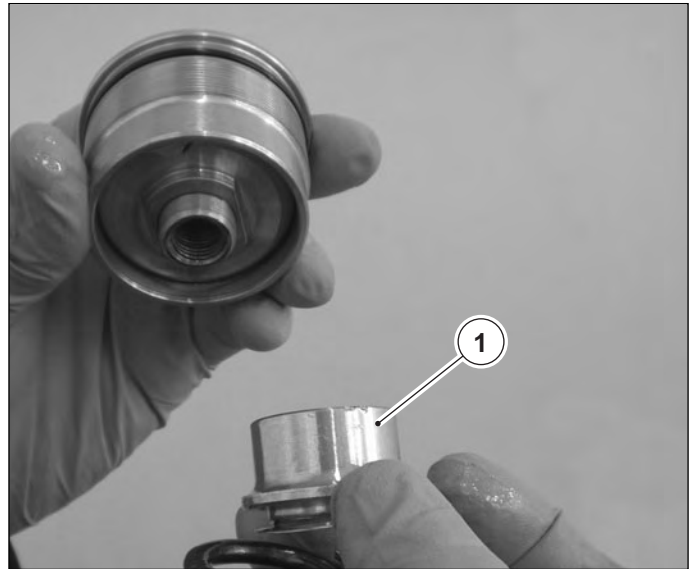

Slide out the spring complete with the spacer.

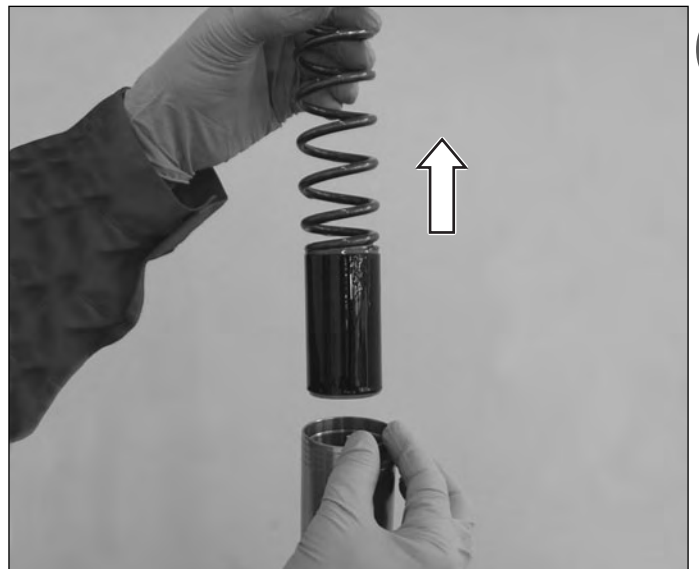

F

Remove the internal rod for adjusting the extension.

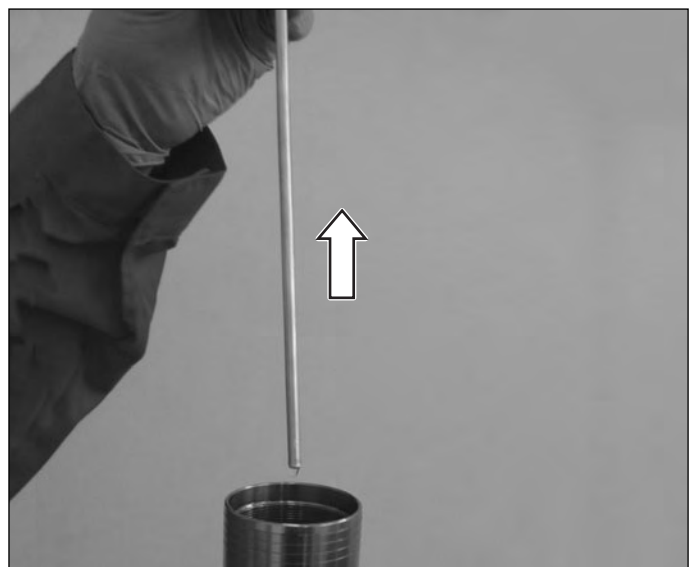



Suspension and wheels

Turn the stem upside down and completely pour out the oil into a suitable container.

 **Recover the oil in an appropriate container. Do not dispose of the used oil in the environment.**



F Unscrew the lower central screw that fixes the pump unit. Collect the seal washer underneath.

 **When reassembling tighten to 40 N•m.**

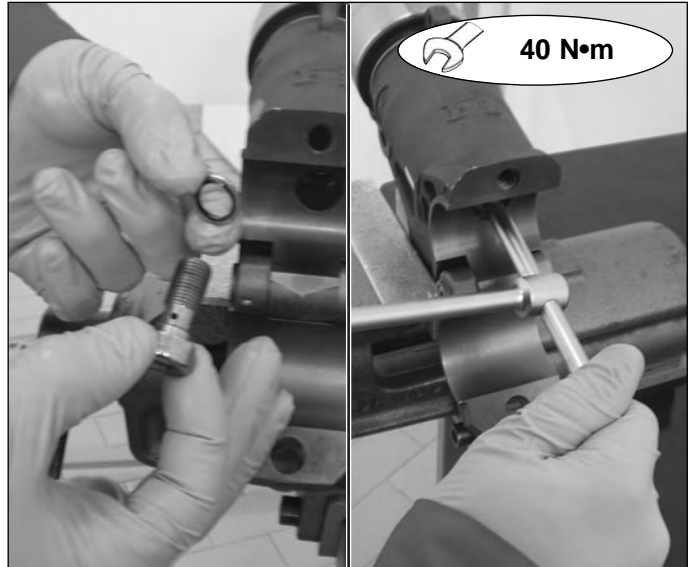

Extract the pump unit.
Check that the sealing ring on the pump is still in its seat (only for MY04 and successive).

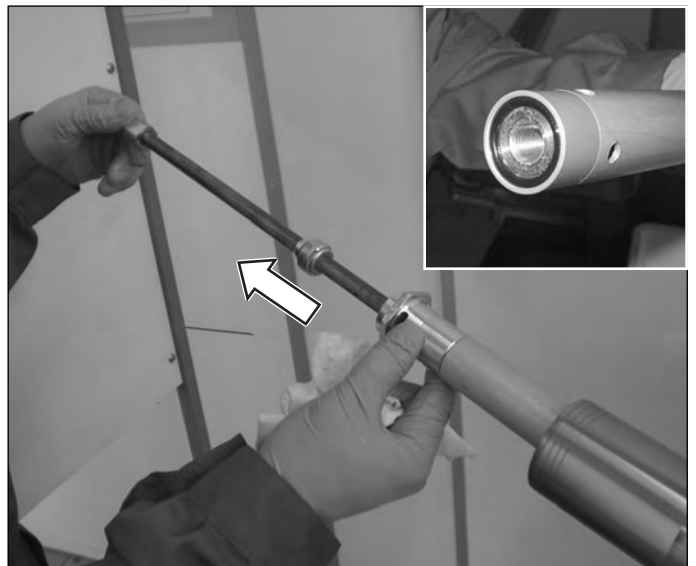



Suspension and wheels

Lower the anti-dust seal (1) taking care to not damage the seat on the sleeve.

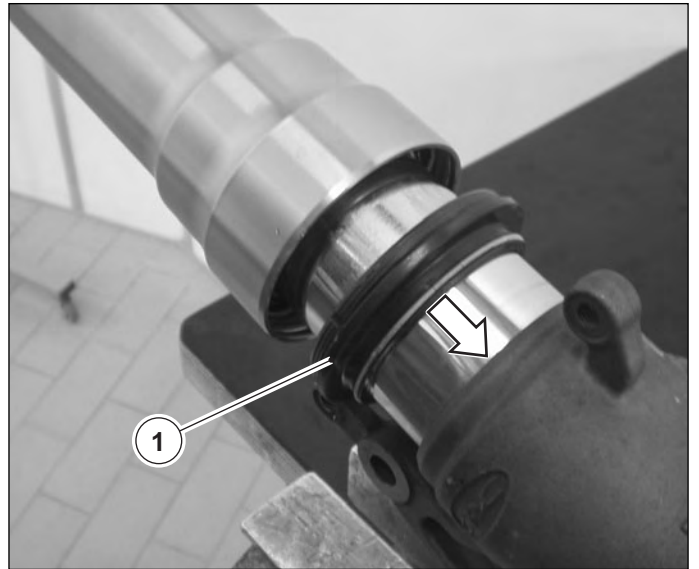

Remove the retaining ring (1) with a screwdriver, taking care to not scratch the stem.

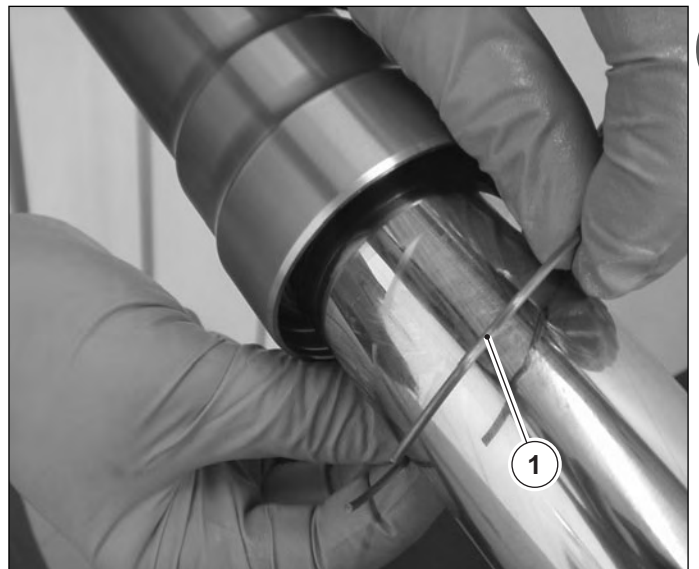

F

Extract the sleeve from the stem by repeated blows at the end.





Suspension and wheels

Unscrew the hydraulic braking adjuster under compression.



F Fork assembly check

Check that the sleeve does not have marks on the external part that could have repercussions inside the assembly. Ensure that the inside is completely smooth, without any scratches.

If necessary, substitute with a new part.

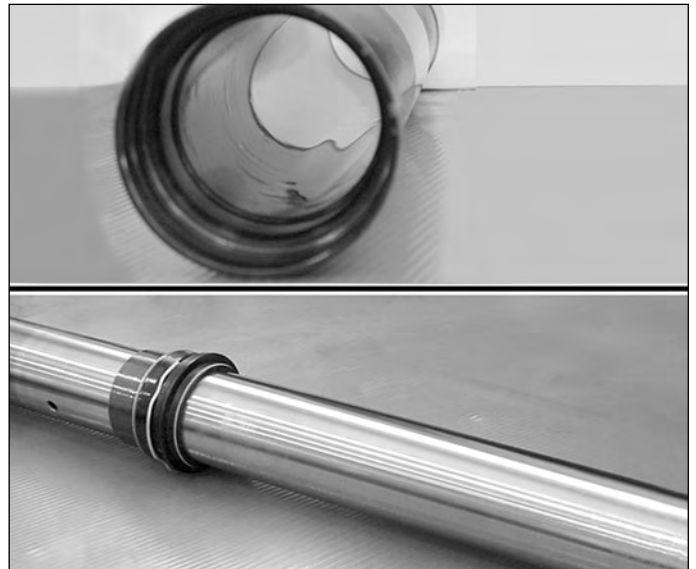

Check for marks or scratches on all surfaces of the stem and check the condition of the chroming.

 Check the length of the spring (**265 mm** minimum).

Manually widen the upper bush and extract it. Remove the lower bush, the washer, the oil seal and the anti-dust seal (see figure).

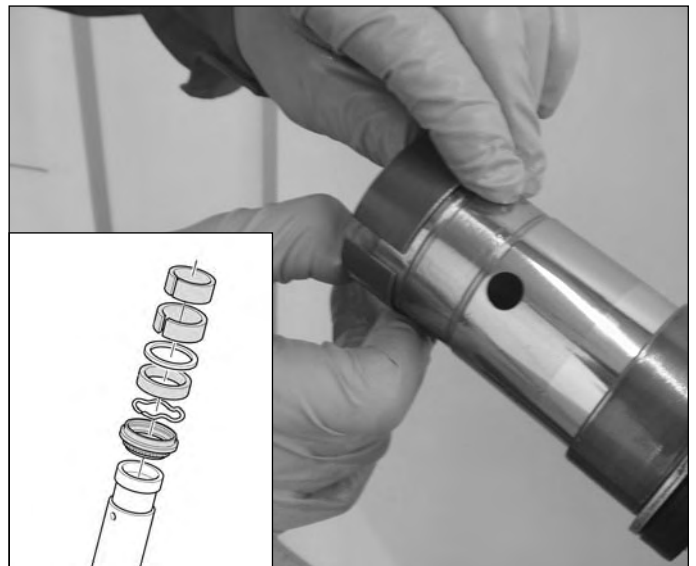



Suspension and wheels

Assembly oil seal and anti-dust seal.

After having carefully checked all components, substitute those damaged and/or deteriorated.

Grease the lips of the new anti-dust seal (1) and the new oil seal (2) with the appropriate grease.

Apply a "sleeve" of nylon to the upper part of the stem (see figure), to protect the oil seal (2) and the anti-dust seal (1) from any sharp edges on the lips of the stem during assembly.



Recommended grease: MOLYKOTE 55M

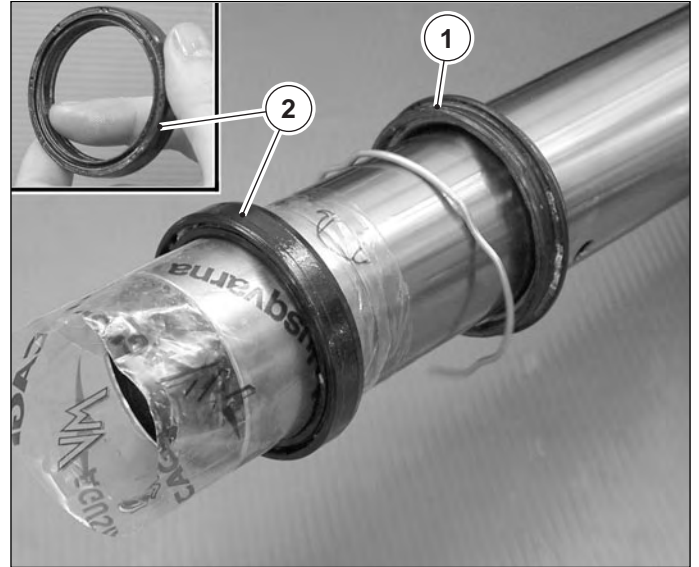

Visually check for scratches and marks on the pump rod and check that it slides smoothly inside the pump unit without chamfering.

Substitute if necessary.



F

Assemble the stem into the sleeve, placing the ferrules into their seats with the respective washers. Utilise the special tool.

Using the same technique, assemble the oil seal and its stop ring and then manually assemble the anti-dust seal.



Special tool N. 8000A1039





Suspension and wheels

Reassemble the hydraulic brake adjuster under compression into its seat by utilising a new O-ring seal.

 **Torque pressure of the compression hydraulic brake adjuster : 20 N•m**



F Insert the internal rod.

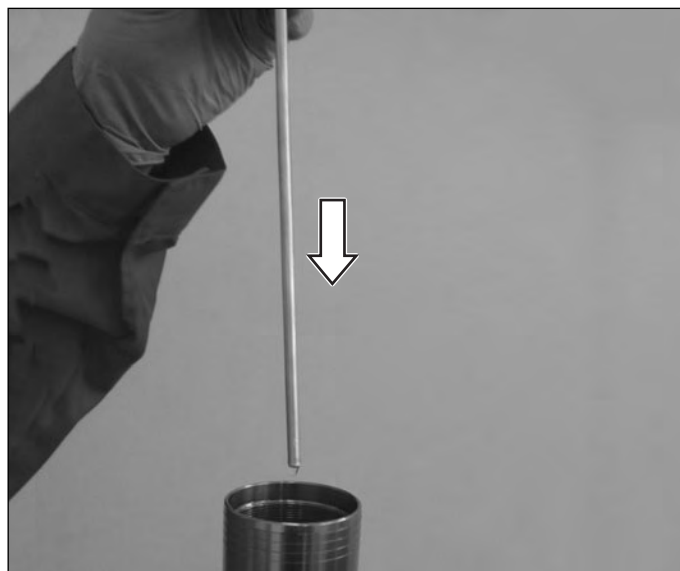

Maintain the sleeve in a vertical position. Introduce the following amount of oil:

- **BRUTALE ORO / S (MY 03):** 646 cc
- **BRUTALE S (MY 04):** 655 cc

Press the pump rod up and down until a perfect fluidity of movement is obtained.

-  **Recommended oil:**
- **BRUTALE ORO / S (MY 03):** SAE 5
 - **BRUTALE S (MY 04):** SAE 7.5

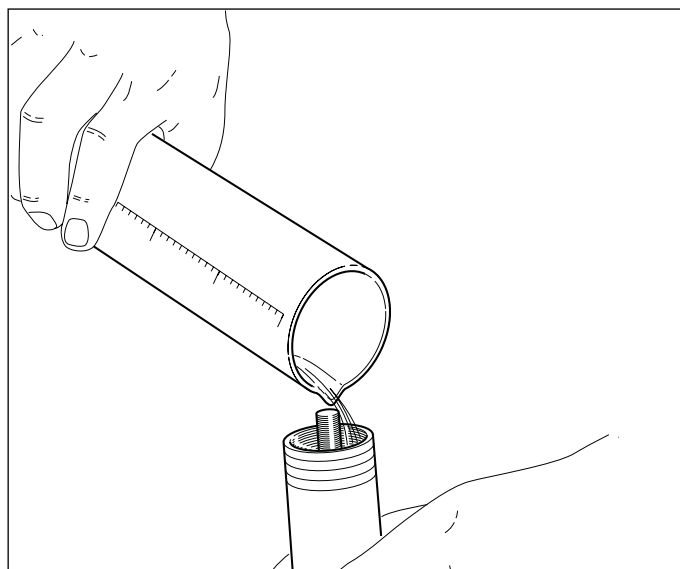



Suspension and wheels

Check that the oil level is at an "X" value from the upper edge of the sleeve, including the upper edge as well.

- BRUTALE ORO / S (MY 03): X = 110 mm
- BRUTALE S (MY 04): X = 105 mm

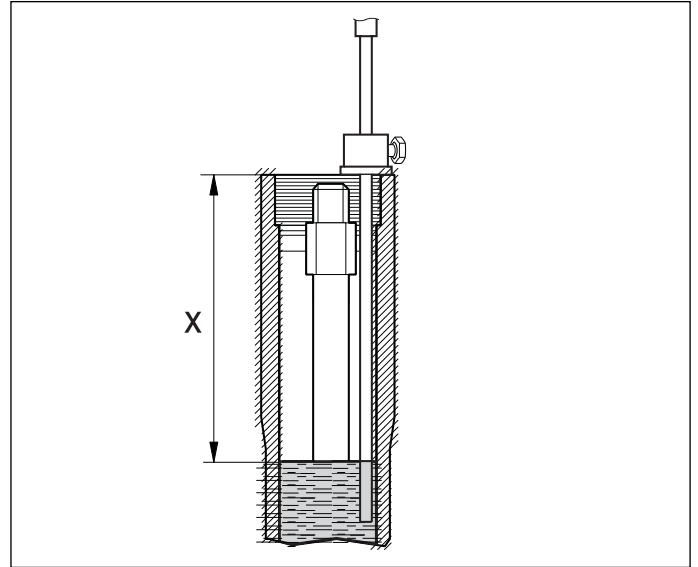

Manually screw in the locknut until it reaches the end of the thread, then introduce the spring with the spacer.



The locknut has a special assembly direction. Pay attention to keep the two support bases facing upwards (see the figure below).



F

Insert the key on the pump nut (1) slightly pressing down the spring.

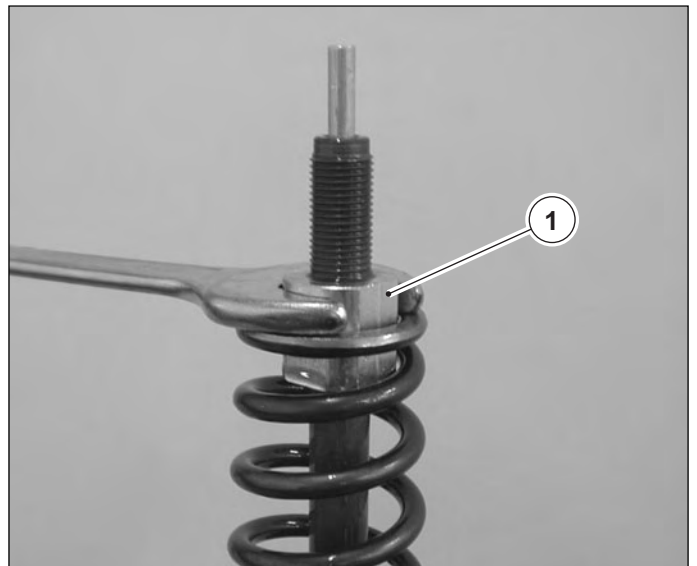



Suspension and wheels

Place the spring-push spacer (1) and the relative washer.

Reassemble the complete cap with a new O-ring. Tighten the cap to the prescribed torque pressure.

 **Stem cap torque pressure: 20 N•m**

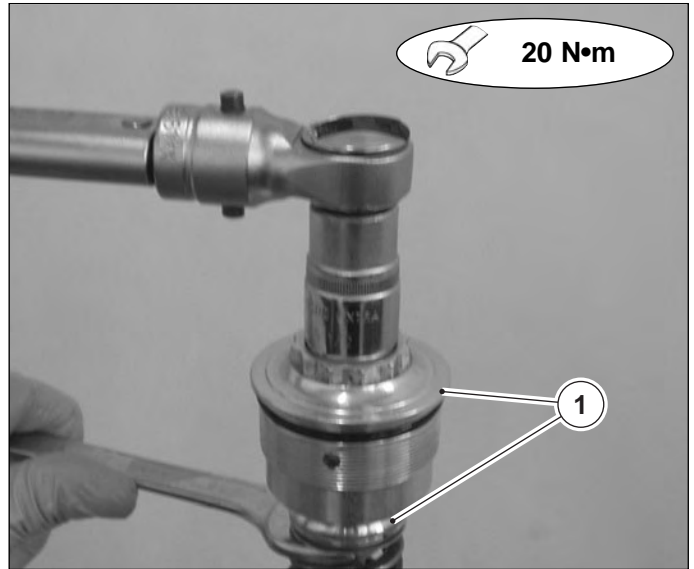

F Reassemble the cap on the stem, tightening it to the prescribed torque pressure.

 **Stem cap torque pressure: 20 N•m**



Fork stem assembly

Assemble the left stem in its seat. To position the stem correctly, refer to the diagram in the figure on the side. Pay attention to respect the "X" assembly dimension, which is reported below:

- **BRUTALE ORO / S (MY 03-04):** **X = 165 mm**

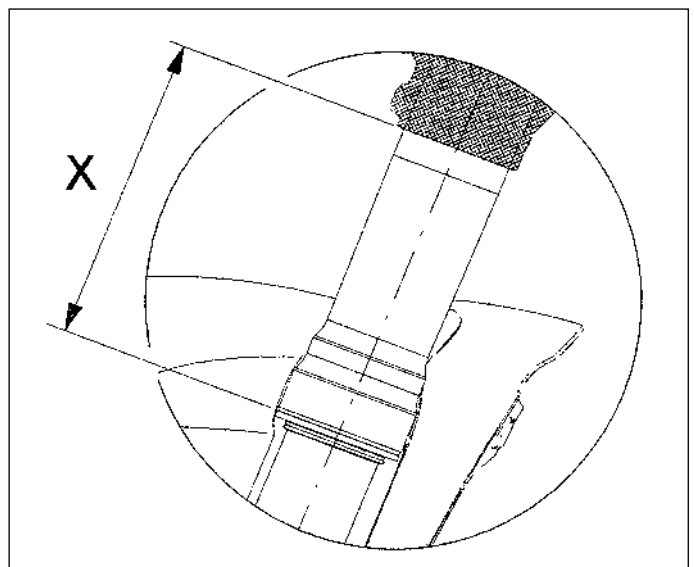



Suspension and wheels

Screw in and tighten the three screws (1) at the base of the steering.

 **Carry out this assembly correctly. A casual or inexact assembly could compromise the stability and steering of the motorcycle.**

Assemble the right stem, in the same way as described for the left stem.



Tighten the three screws (1) at the base of the steering; effectuate the operation several times until the prescribed torque pressure is reached. This operation must be carried for both stems.

 **Torque pressure of the screws at the base of the steering: $8 \div 9 \text{ N}\cdot\text{m}$**

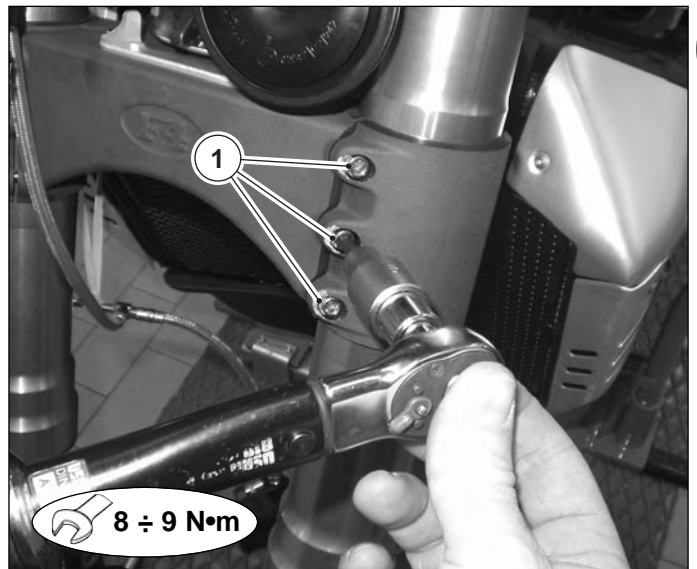

Slacken the central screw (3) of the steering head. Ensure that the steering head is sitting perfectly in its seat.

Tighten the two screws (2) of the steering head to the prescribed torque pressure and successively tighten the central screw (3).

 **Torque pressure of the external screws (2): $16 \div 18 \text{ N}\cdot\text{m}$**

 **Torque pressure central screw (3): $22 \div 24 \text{ N}\cdot\text{m}$**

 **This check is necessary for the correct positioning of the stems even if the steering head has not been removed.**

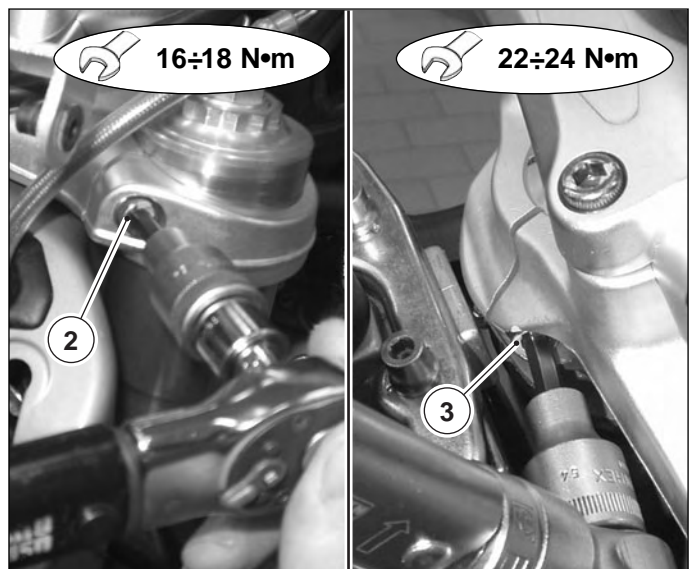

F



Suspension and wheels

Reassemble the front wheel introducing the wheel spindle inside the fork attachments.
Fix the attachments with the screws (1) tightening them to the prescribed torque pressure.

 **Torque pressure of the fork attachment screw: 20 ÷ 22 N•m**

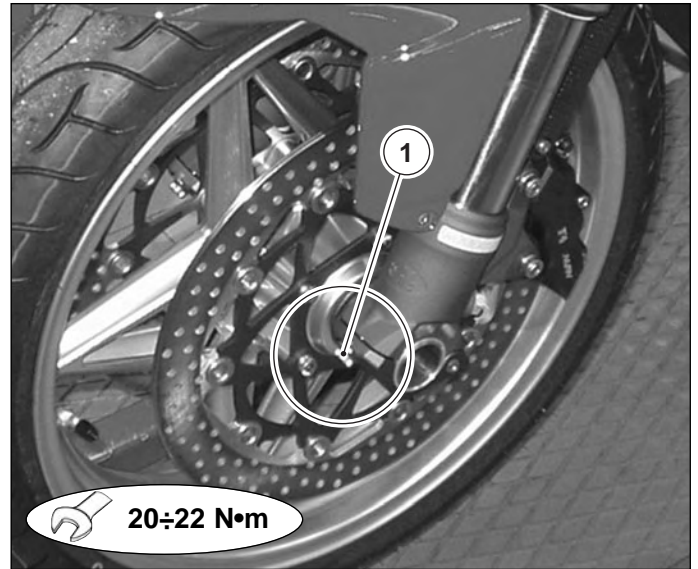

F Front suspension adjustment

After having correctly reassembled the entire fork assembly, it is necessary to re-establish the adjustments shown in the table to guarantee the best set-up of the motorcycle. Carry out the same adjustment on both fork stems.

 **It is necessary that the adjusters on both fork stems are adjusted to the same position.**

<i>Brutale ORO</i>	<i>Type of set-up</i>		
	<i>Soft</i>	<i>Standard</i>	<i>Hard</i>
Spring preload	0 turns	2 turns	4 turns
Braking in extension	13 clicks	10 clicks	7 clicks
Braking under compression	11 clicks	8 clicks	5 clicks



<i>Brutale S (MY 03)</i>	<i>Type of set-up</i>		
	<i>Soft</i>	<i>Standard</i>	<i>Hard</i>
Spring preload	2 turns	4 turns	6 turns
Braking in extension	13 clicks	10 clicks	7 clicks
Braking under compression	11 clicks	8 clicks	5 clicks

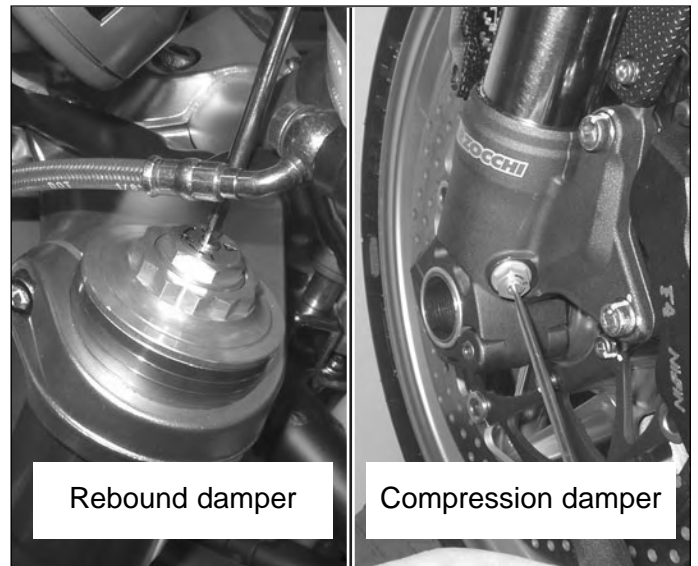

<i>Brutale S (MY 04)</i>	<i>Type of set-up</i>		
	<i>Soft</i>	<i>Standard</i>	<i>Hard</i>
Spring preload	1 turns	2 turns	3 turns
Braking in extension	12 clicks	10 clicks	7 clicks
Braking under compression	12 clicks	10 clicks	7 clicks

STEERING ASSEMBLY

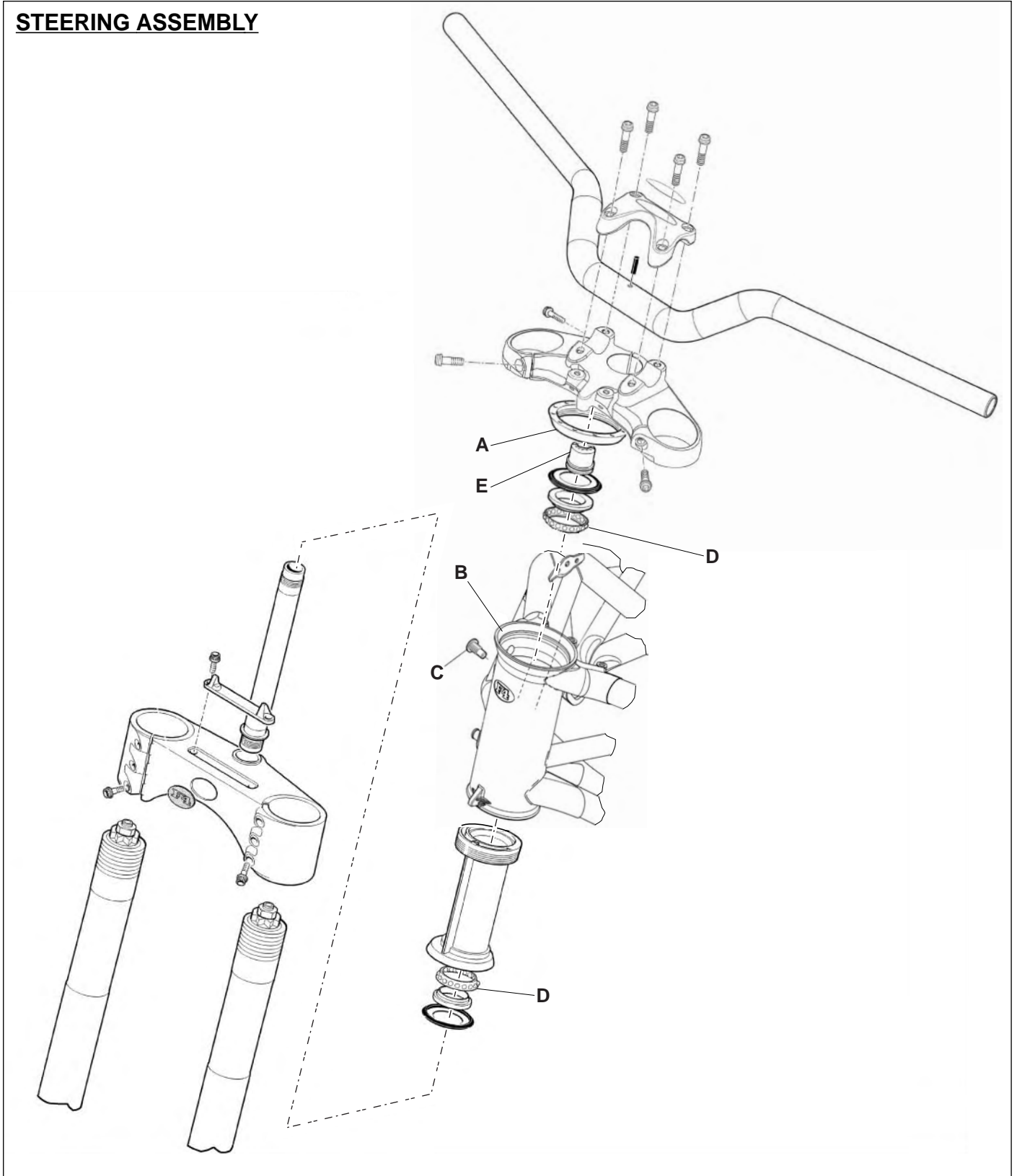

F

		A	B	C	D	E				
Torque pressu- re	N·m	95 ÷ 100		18 ÷ 20		In contact + 10°				
	Kg·m									
	ft·lb									
Operation						270				

STEERING ASSEMBLY OVERHAUL

To operate on the steering assembly, it is necessary to remove the fork stems as described in this chapter, in the paragraph "Front fork overhaul".

Then remove the components according to the following order:

- front headlight;
- instrument panel;
- handlebars;
- headlight support;

as described in chapter C "Bodywork".

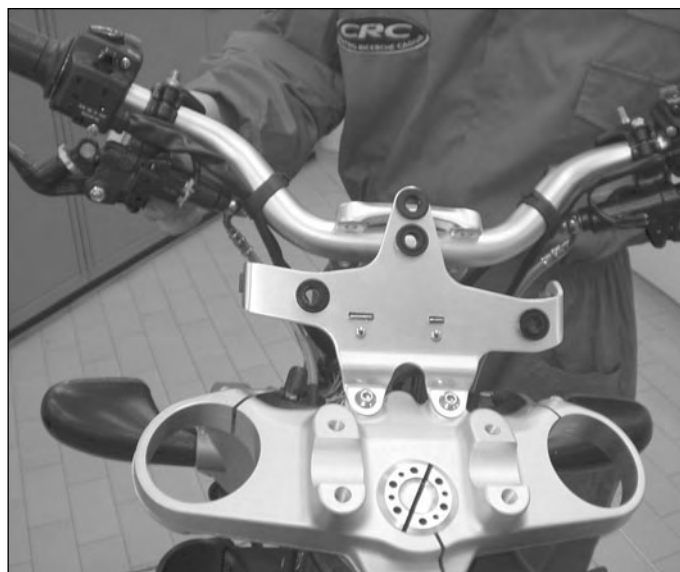

F Steering head removal

Slacken the fixing screw (1) of the steering head and remove it from the steering pin.

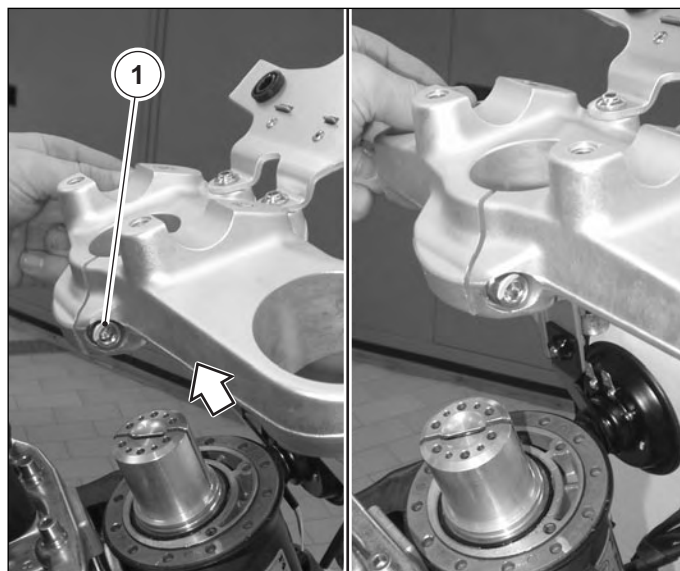

Steering base removal

Utilising the special tool, slacken the screw ring of the steering pin.

Support the motorcycle sufficiently enough so that the front stand can be removed. Ensure that the brake pin-cers are securely placed.

 **Special tool N. 800091645**





Suspension and wheels

Remove the screw ring previously slackened and remove the steering base complete with the pin. Remove the anti-dust seal, the internal bearing ring and the ball bearing ring.



Eccentric steering head removal

With the special tool remove the fixing screw ring of the eccentric steering head.



Special tool N. 800092857



During this operation press the tool with the palm of the hand along the axis of rotation and at the same time support the motorcycle.



F

Disassembly of the frame head steering sleeve

Remove the adjustment screw of the frame head steering sleeve, sustaining the frame head steering sleeve at the lower part.





Suspension and wheels

Reassembly of the frame head steering sleeve

Clean the parts accurately so that a visual check can be made of the tube and the seats.

There should not be marks or lines in the bearing seats. If so, substitute the parts as necessary.



F

Lightly grease the contact area of the frame head steering sleeve (see figure) and the threaded part with **Agip Grease 30**.

Accurately clean the bearing seats on the frame head steering sleeve.



Recommended grease Agip Grease 30



Reassemble the frame head steering sleeve aligning the slot on the frame head steering sleeve with the threaded hole on the frame head (see figure).

When the slot is in correspondence with the threaded hole of the frame head screw in the grub screw (1), **without tightening**. Just enough to keep the steering head in its seat.

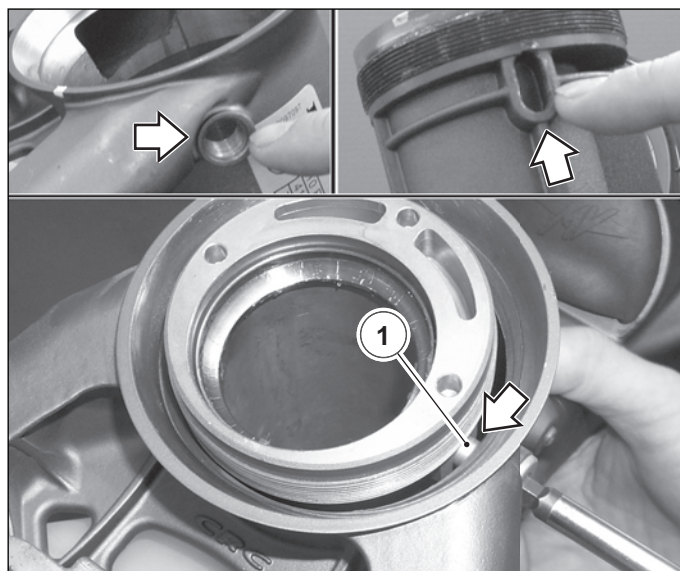

The tightening of the grub screw (1) at this stage would compromise the set-up of the steering head in its frame seat.



Suspension and wheels

Screw ring assembly

After having accurately cleaned the screw ring and the seat of the steering head on the frame, apply the prescribed grease both on the threading and on the conical part of the screw ring, then screw it manually onto the relative seat.



Recommended grease Agip Grease 30



Utilising the special tool, tighten the screw ring (1) to the prescribed torque pressure.



Special tool N. 800092857



Torque pressure of the frame head steering sleeve screw ring: $95 \div 100 \text{ N}\cdot\text{m}$

During this tightening operation, press down with force along the axis of rotation of the tool (see figure).

Tighten the grub screw (2) of steering head.



Torque pressure of the grub screw of the steering head: $18 \div 20 \text{ N}\cdot\text{m}$

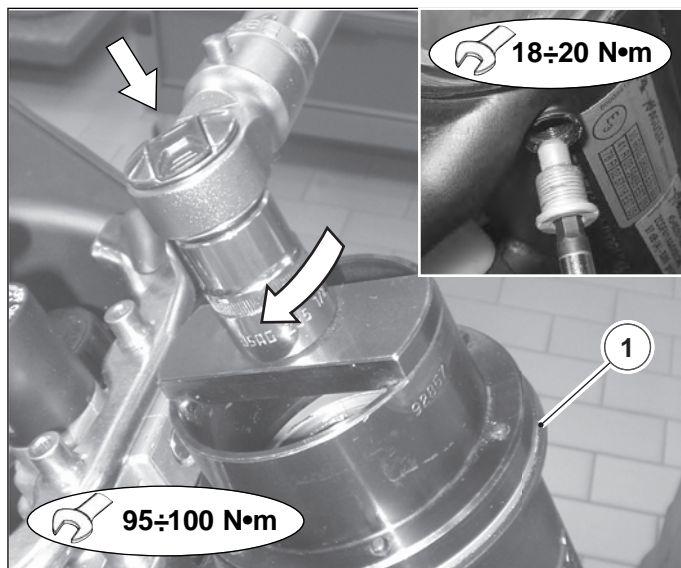

Assembly steering base

Accurately clean all the parts and check the general condition.

Before reassembly, grease the internal ring of the bearing and the ball bearing ring on the steering pin with **Agip Grease 30**.



Recommended grease Agip Grease 30





Suspension and wheels

Assemble the steering base to the eccentric steering head.

Assemble the upper ball bearing ring already greased.
Assemble the internal ring of the bearing, the anti-dust seal and the screw ring of the steering pin.



F Steering pin tightening

Screw down, without tightening, the screw ring of the steering pin.

This operation must be done manually.

Ensure that the steering base is at the end of stroke, completely steered to the right.

Utilising the special tool, tighten the screw ring (1) by rotating it 10° (see figure), calculable as **one-third** distance between the two holes of the steering head screw ring (2).

 **Special tool N. 800091645**

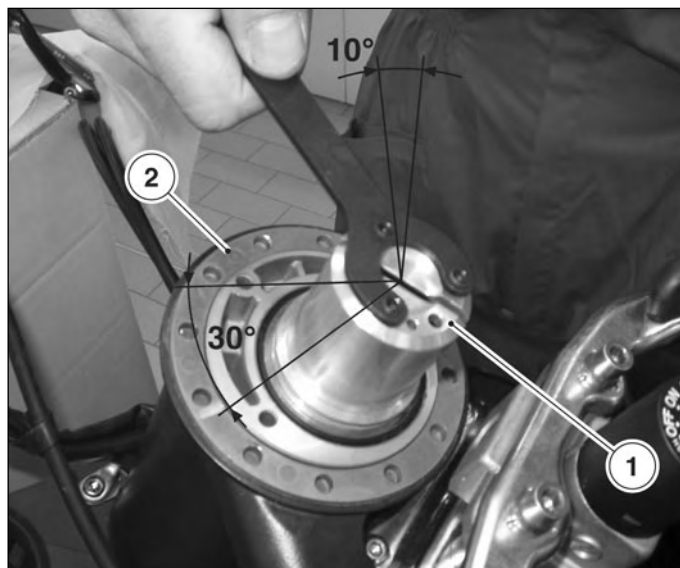

Assembly steering head

Position the steering head in its seat.

Reposition the fork stems as described previously in this chapter.

Tighten the three screws of the steering head as described previously.

N.B. Check the exact position of the fork stems.



REAR SUSPENSION AND FORK

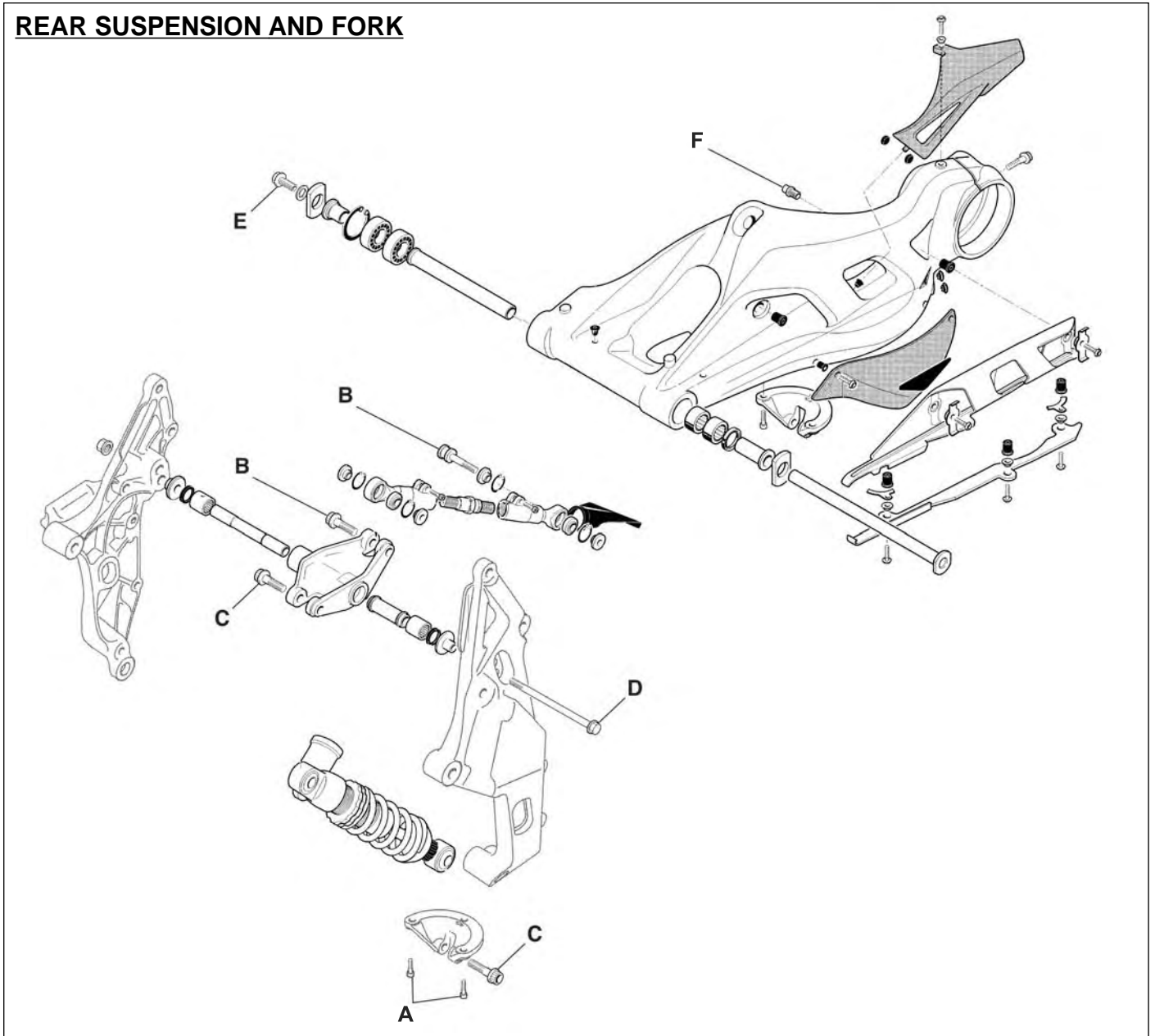

		A	B	C	D	E	F	G	H	I	L
Torque pressure	N.m	40 ÷ 44	40 ÷ 44	40 ÷ 44	50 ÷ 55	70 ÷ 75	30 ÷ 35				
	Kg.m										
	ft-lb										
Operation		243					243				

Description	BRUTALE ORO	BRUTALE S
REAR SUSPENSION		
Type	Progressive with mono-arm fork and mono-shock absorber adjustable for extension, compression and spring preload	
Mono-arm fork	Magnesium alloy	Aluminium alloy
Wheel travel (mm)	120	120

During the disassembly and check of the rear suspension assembly, it is advisable to disassemble the fuel tank, as described in chapter C "Bodywork".



Suspension and wheels

Disassembly rear shock absorber

Remove the fuel tank as described in chapter C "Bodywork".

Lift up the rear part of the motorcycle (utilising a lift and safety straps) high enough to take the load off the shock absorber.

Slacken the upper screw of the shock absorber (1).

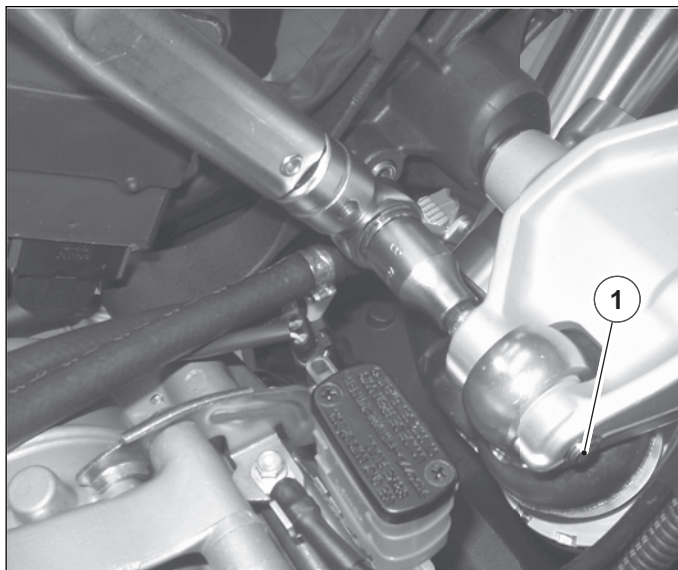

F Slacken the central screw (1) of the rear wheel compensator assembly.

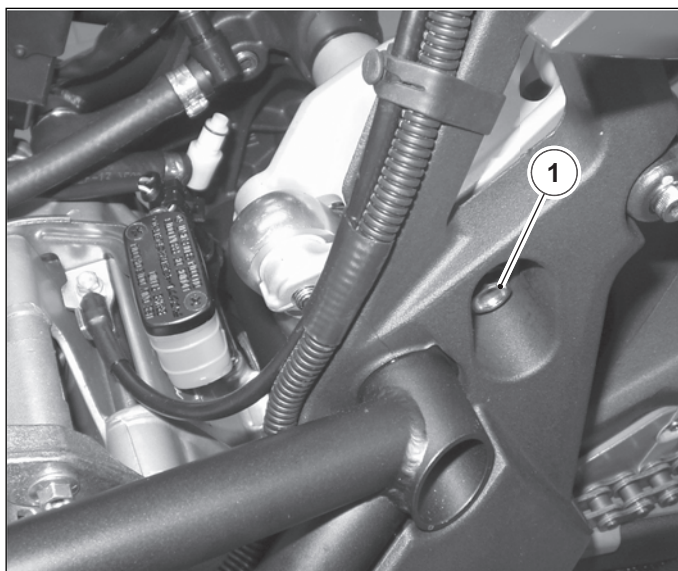

Slacken the lower screw of the shock absorber (1).

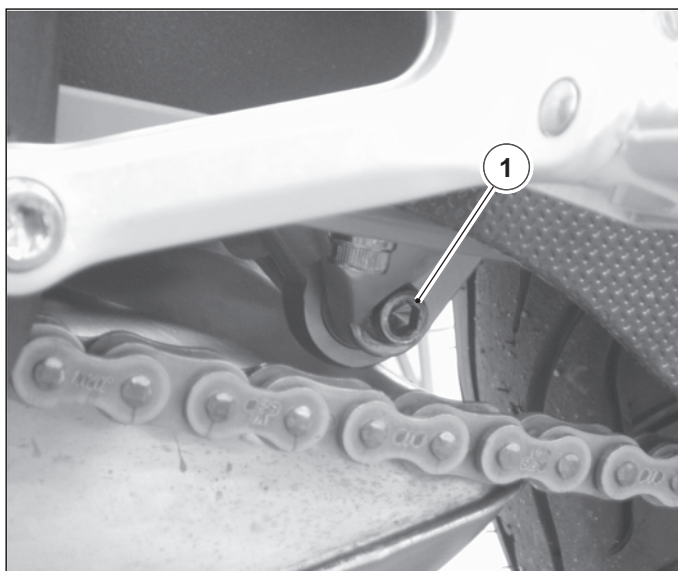



Suspension and wheels

Raise up or lower the motorcycle utilising the lift so that the previously slackened screws are freed.
Remove the pin (1) of the compensator assembly, remove the upper screw of the shock absorber.

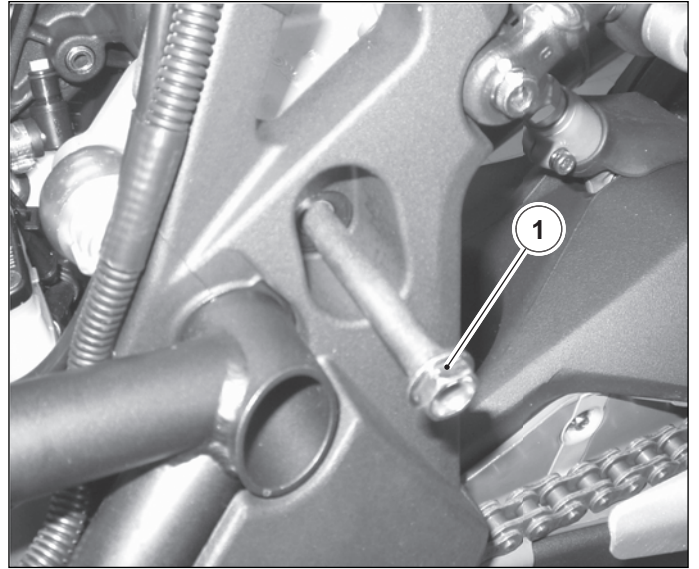

Slacken the central fixing pin of the engine (1).
Slacken the rear fork pin (2).
These operations are necessary to free the compensator assembly.
Lift up the compensator assembly.
Remove the upper screw of the shock absorber that was previously slackened.
Extract the complete rear shock absorber upwards.

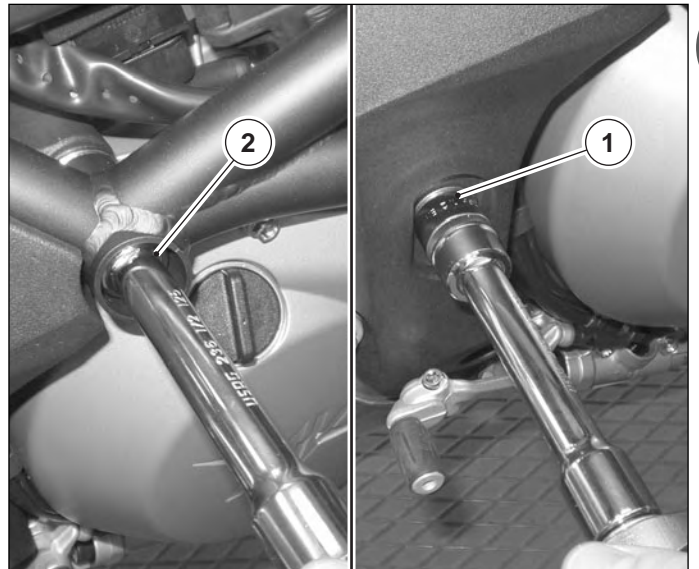

F

Rear shock absorber test

Check that the lower and upper bolt holes do not have axial (A) and radial (B) play.

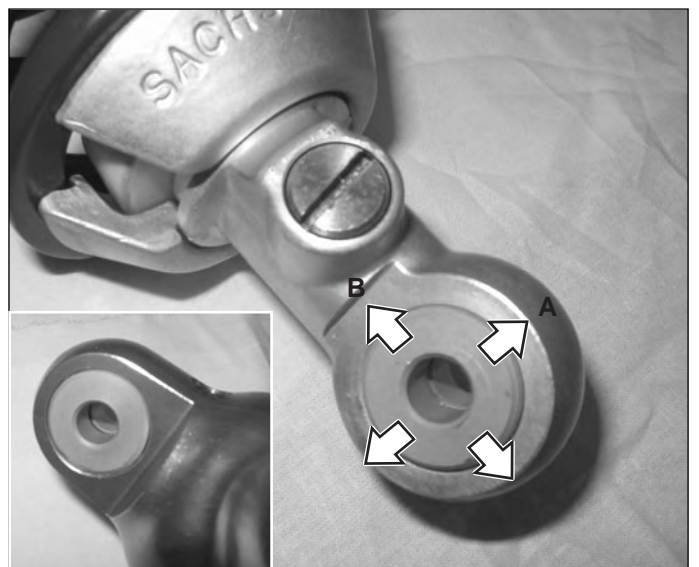



Suspension and wheels

Check the length of the rear shock absorber spring.

Standard spring adjustment (A):

- BRUTALE ORO / S (MY 03): A = 151 mm
- BRUTALE S (MY 04): A = 154 mm

Check the functioning of the adjusters.



The shock absorber contains high-pressure gas. Do not touch the valve of the shock absorber tank. Do not try to disassemble the shock absorber.

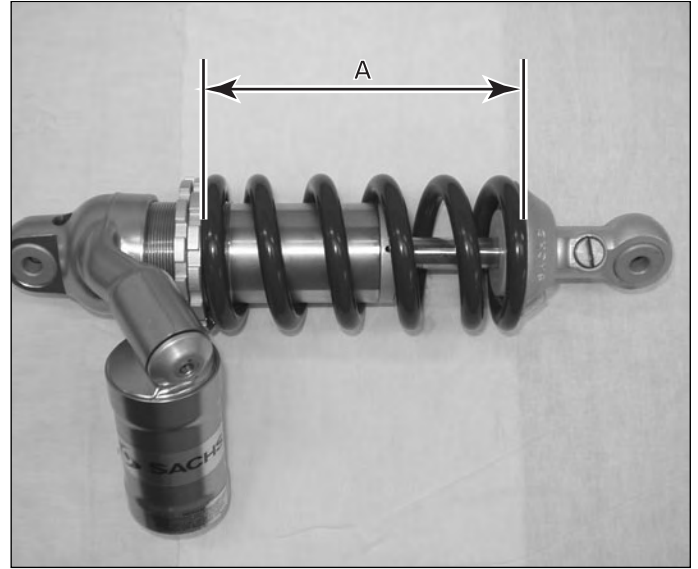

Rear suspension adjustment

N.B. The following operations can be also carried out with the rear shock absorber assembled to the motorcycle.

BRUTALE ORO BRUTALE S (MY 03)	Type of set-up (only rider)		
	Soft	Standard	Hard
Braking in extension	21 clicks	17 clicks	13 clicks
Braking under compression (high speed)	0 clicks	6 clicks	12 clicks
Braking under compression (low speed)	18 clicks	15 clicks	12 clicks
BRUTALE ORO BRUTALE S (MY 03)	Type of set-up (with passenger)		
	Soft	Standard	Hard
Braking in extension	21 clicks	17 clicks	13 clicks
Braking under compression (high speed)	6 clicks	12 clicks	18 clicks
Braking under compression (low speed)	18 clicks	15 clicks	12 clicks

BRUTALE S (MY 04)	Type of set-up (only rider)		
	Soft	Standard	Hard
Braking in extension	12 clicks	8 clicks	7 clicks
Braking under compression (high speed)	0 clicks	6 clicks	12 clicks
Braking under compression (low speed)	15 clicks	12 clicks	8 clicks
BRUTALE S (MY 04)	Type of set-up (with passenger) *		
	Soft	Standard	Hard
Braking in extension	8 clicks	8 clicks	8 clicks
Braking under compression (high speed)	18 clicks	18 clicks	18 clicks
Braking under compression (low speed)	12 clicks	12 clicks	12 clicks

N.B. (*): For Brutale S MY 2004 only: to use the motorcycle with a passenger it is advisable to increase the spring preload of the shock absorber by two turns compared to the standard set-up (see set up adjustment on page 58).



Rebound damper

Compression damper

Compensator assembly removal

Remove the special screw (1) that fixes the compensator assembly of the rear suspension to the mono-arm fork.

Extract the complete compensator assembly.

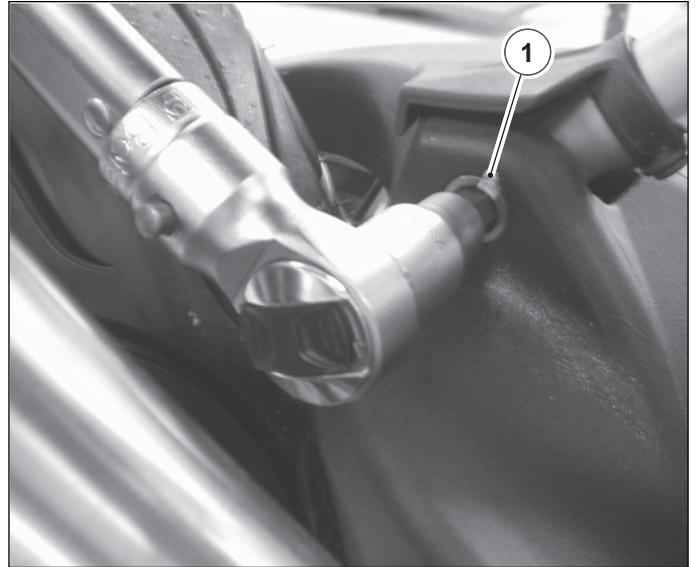

Compensator assembly overhaul

Remove the anti-dust seal (1).

Check the condition of the roller bearings and if it is necessary to substitute them, utilise an extractor as shown in the figure.

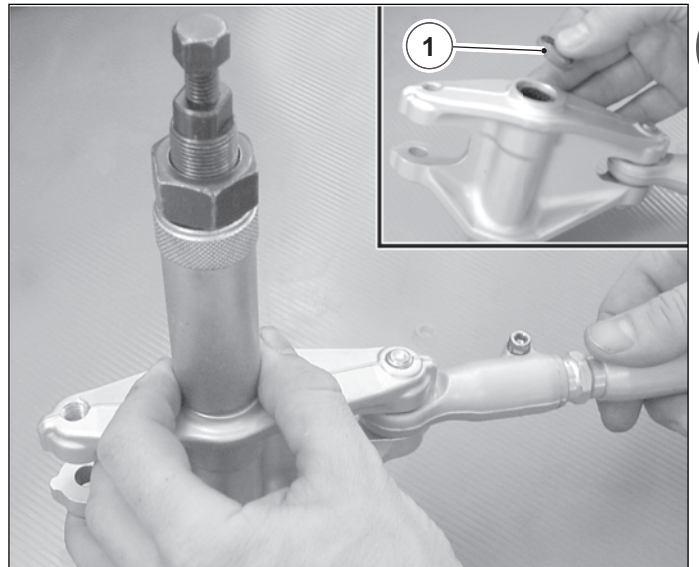

Check for eventual axial play of the bolt holes of the connecting rod (2).

Substitute if worn.

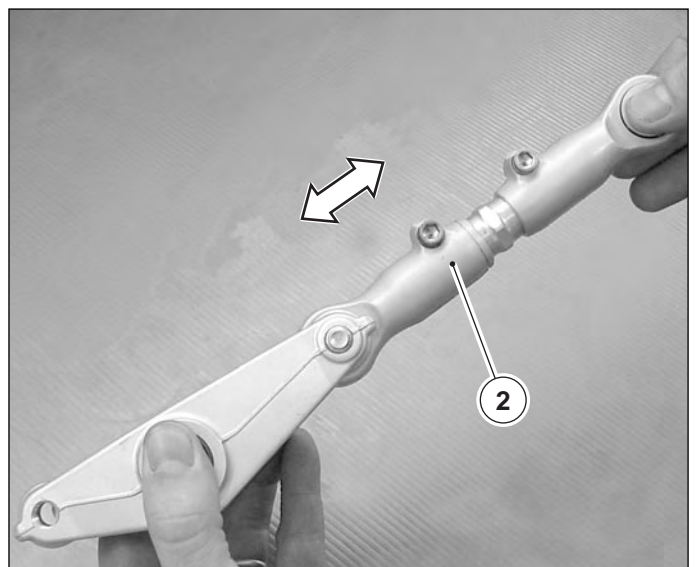

Rear shock absorber support plate removal

Remove the three screws (1) indicated in the figure and remove the support plate (2).

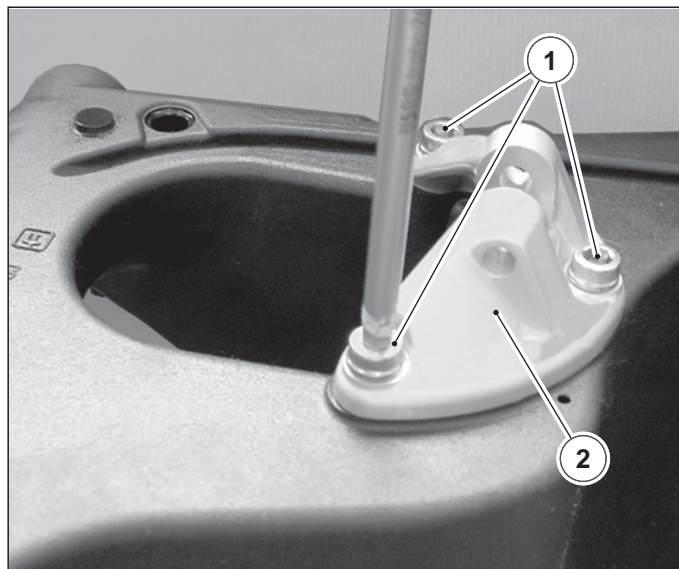

F When reassembling, it is necessary to apply a special product to the three screws. Lightly screw them in. Tighten the central screw first and then the other two to the prescribed torque pressure.



Special product Loctite 243



Torque pressure: 40 ÷ 44 N•m



Upper chain guide removal

Remove the two screws (1) and the relative plates. Lift up the front part of the chain guide to remove it from the mono-arm fork (see figure).

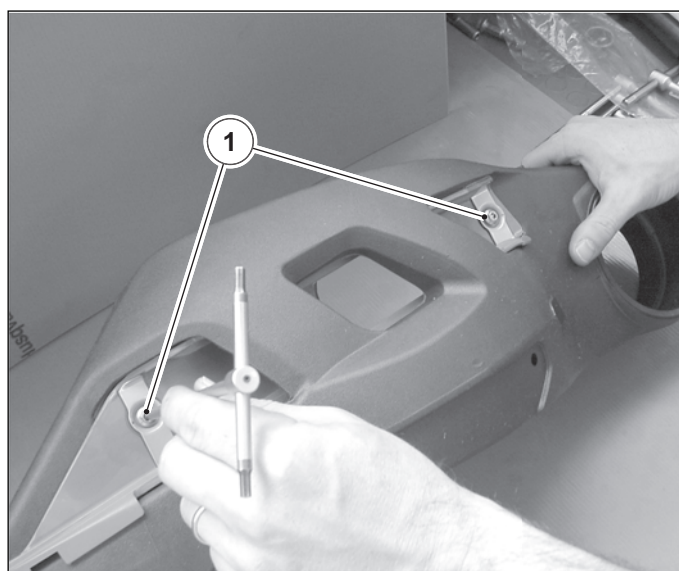

Repeat the operation on the rear part, where the screw seat is situated in the mono-arm fork.

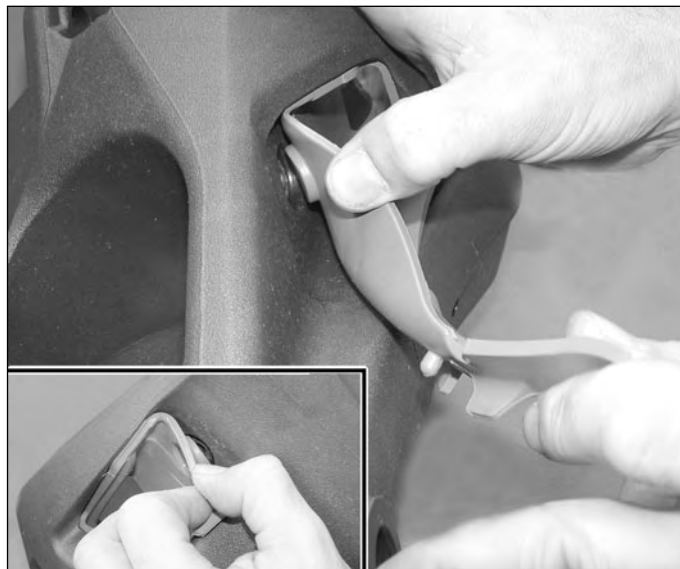

Slide out in a forward position as shown in the figure. When reassembling, proceed in the reverse order of removal ensuring the correct positioning of the front reference peg.

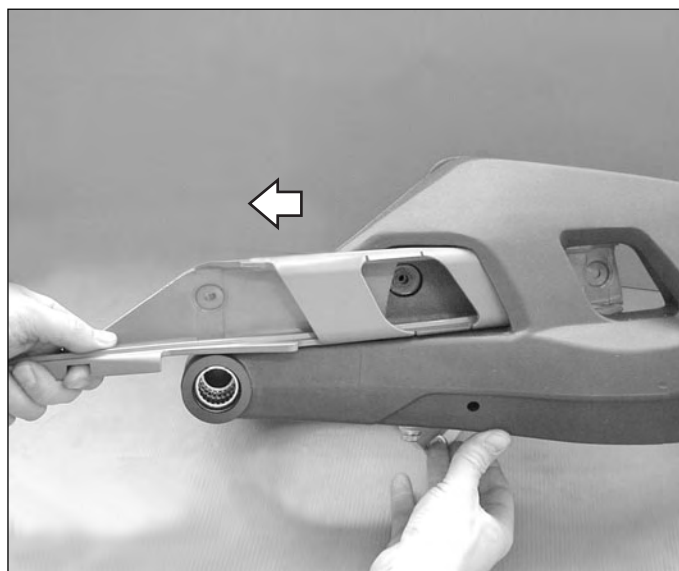
**F**

Reassembly compensator assembly

Reassemble the compensator assembly after having cleaned and greased the seat of the special screw situated on the mono-arm fork.

Screw in the screw without tightening it.



Recommended grease : Agip Grease 30



Assembly rear shock absorber

Accurately clean all parts. Grease the screws with Agip Grease 30 before reassembly.

Insert the shock absorber from above and lightly screw in the lower screw of the shock absorber.

Centralise the compensator assembly and replace the pin. Screw on the nut of the pin without tightening it.

Insert the shock absorber into the compensator assembly and lightly screw in the screw.



Lower the motorcycle to the ground, remove the lift and safety straps.

This operation is necessary to recover the play between the shock absorber/compensator assembly/mono-arm fork.



Recommended grease: Agip Grease 30



Tighten up the whole assembly:

Tighten the screws of the connecting rod.

Tighten the lower and upper screw of the shock absorber.

Tighten the screw of the compensator assembly (1).

Tighten the frame pin (2).

Tighten the mono-arm fork pin (3).



Apply Agip Grease 30 only to the threads of the screws.



Connecting rod torque pressure: 40 ÷ 44 N•m

Shock absorber torque pressure 40 ÷ 44 N•m

Compensator assembly torque pressure 50 ÷ 55 N•m

Frame pin torque pressure 55 ÷ 60 N•m

Mono-arm fork torque pressure 70 ÷ 75 N•m



Recommended grease: Agip Grease 30

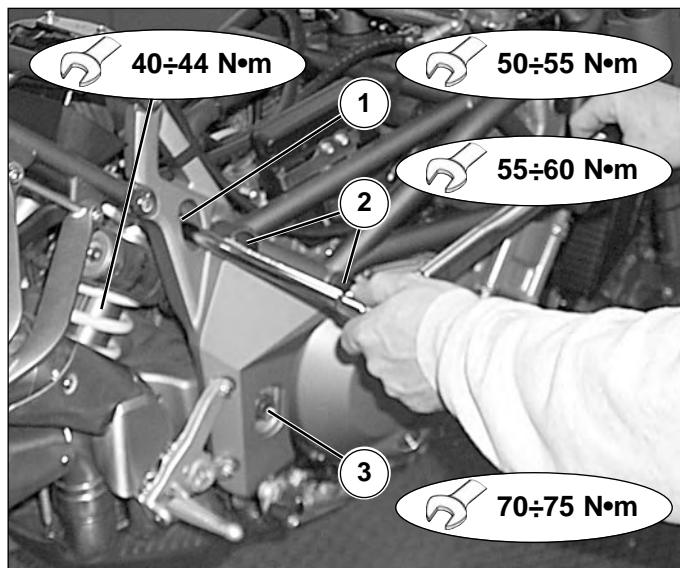

MONO-ARM FORK REMOVAL AND OVERHAUL

Before removing and overhauling the mono-arm fork, it is necessary to execute the following preliminary operations:

- Remove the rear shock absorber and connecting rod as described in the paragraph "Disassembly rear shock absorber" e "Compensator assembly removal" of this chapter.





Suspension and wheels

Rear wheel removal

Remove the rear wheel as described in the paragraph "Rear wheel removal" of this chapter.

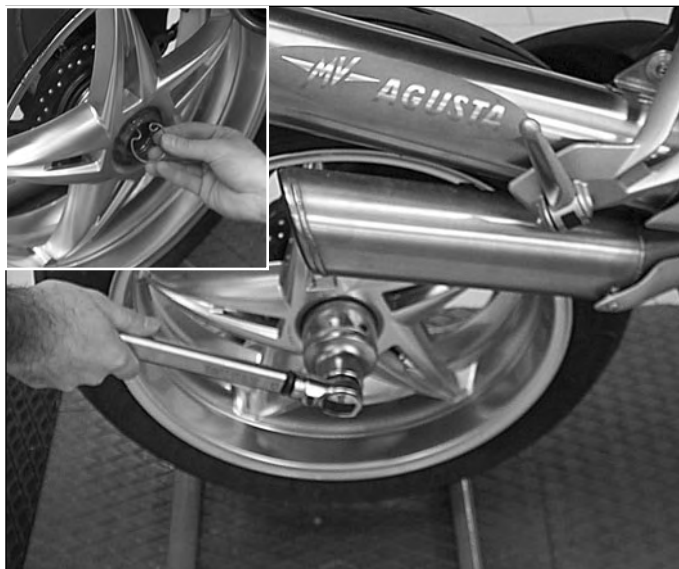

Silencers removal

Unhook the two connecting springs between the silencers and the exhaust group.

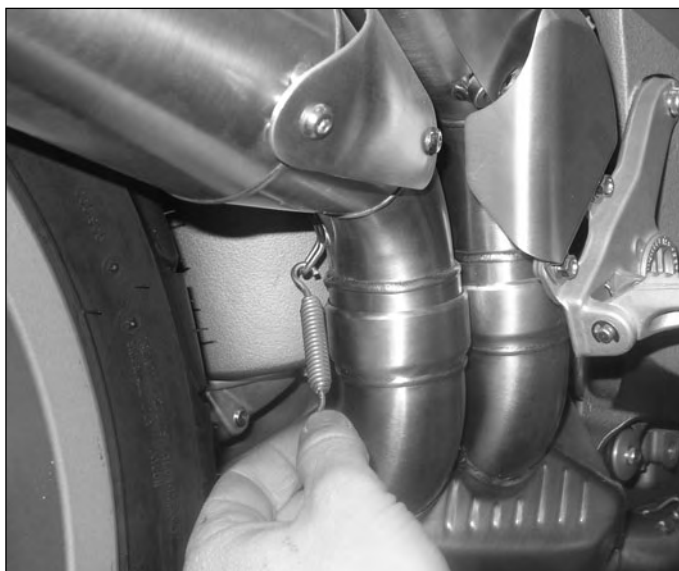

Remove the plate connecting the two silencers.





Suspension and wheels

Unscrew the screw fixing the silencers to the support.



F Remove the upper silencer first, then the lower one.

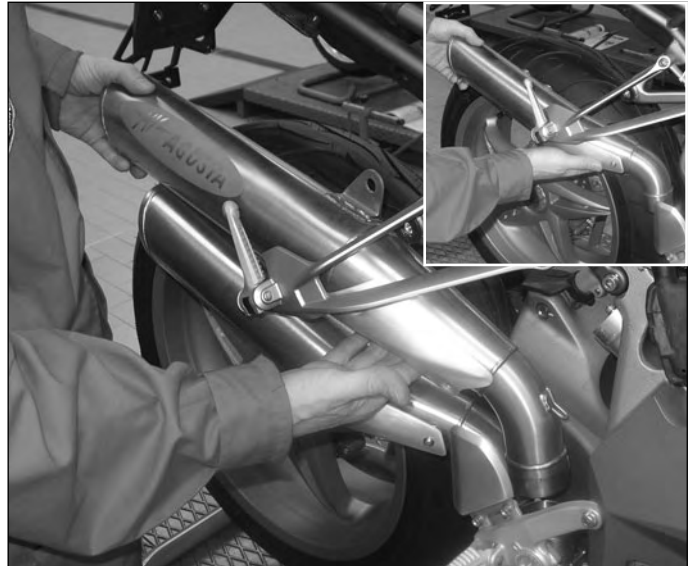

Exhaust group removal

Unhook the two connecting springs between the silencers and the exhaust collectors.





Suspension and wheels

Unscrew the screw fixing the compensator to the frame.

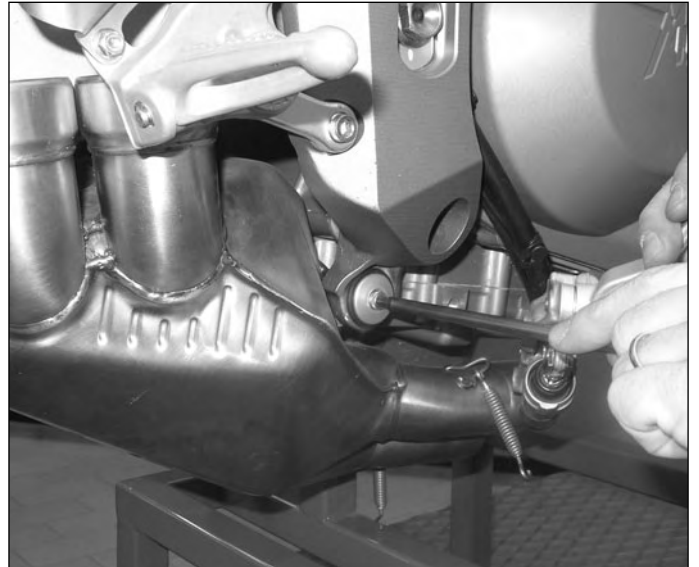

Remove the exhaust compensator to remove it from the pin on the left side of the frame.



F

Lower chain guide removal

Remove the three screws of the chain guide.
Remove the chain guide (1) complete with the two rear brake tube guide plates.

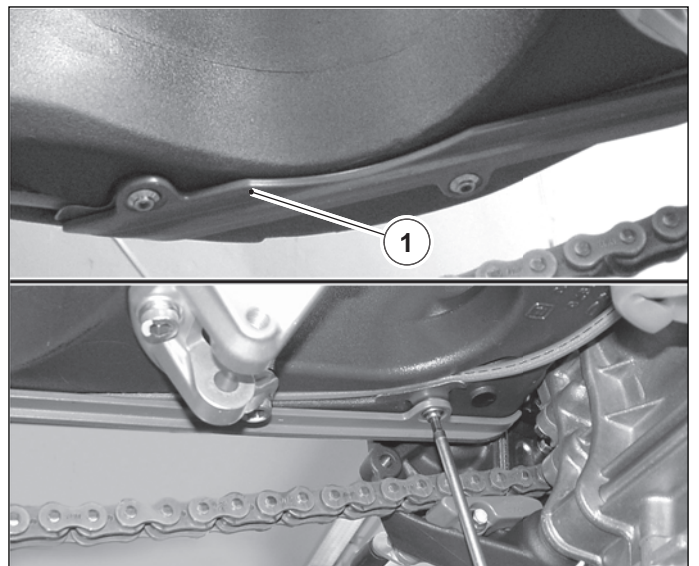



Suspension and wheels

Upper chain guard removal

Remove the screw complete with ferrule.
Extract the chain guard by pulling it out from the back part of the wheel (see figure) so that it is freed from its position on the mono-arm fork.



Chain removal

Remove the chain utilising the special tool.



Special tool N. 800095389.

Identify the connecting link.
The part of the tool being indicated must operate on the internal part of the crown wheel.

N.B. The tool has two functions:

- As a chain cutter: with a punch mounted aligned at A.
- As an anvil: with a raised punch aligned at B.

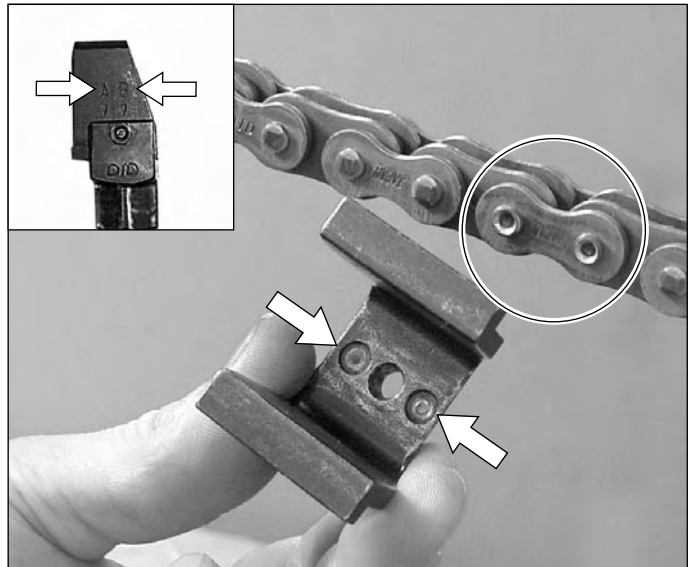

Pre-assemble the tool as shown in the figure.
Align a pin with the central hole of the tool.

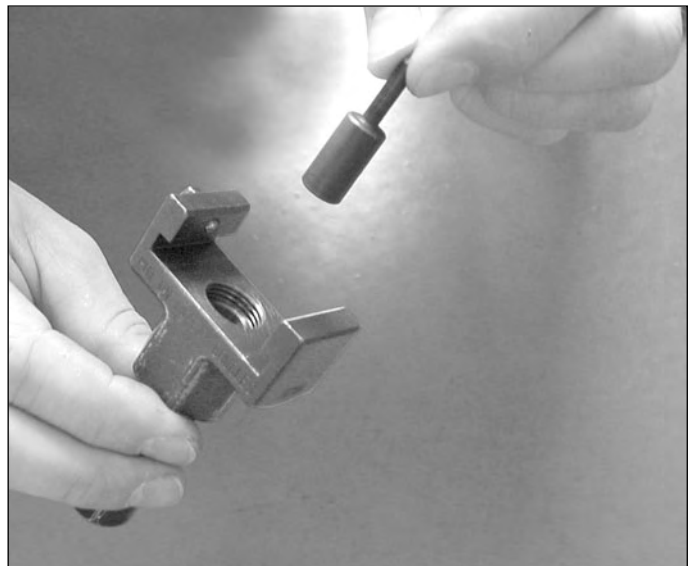



Suspension and wheels

Mount the tool onto the chain as shown in the figure and align the punch on «A».
Operate as shown in the figure.

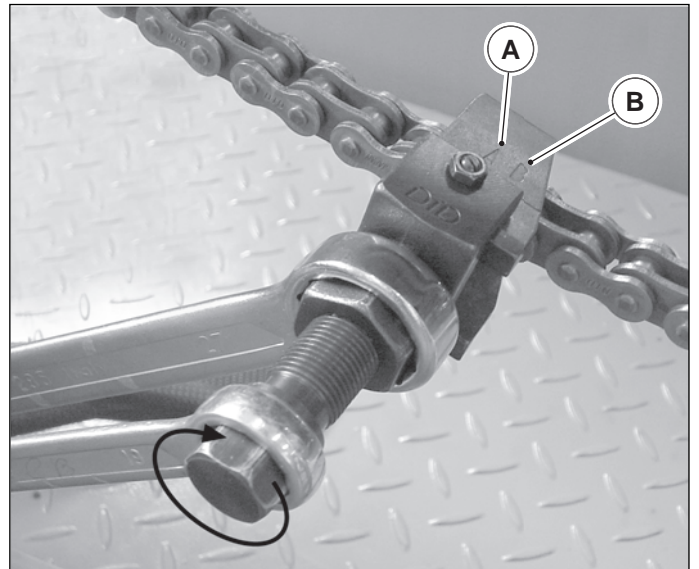

To reassemble the chain, operate in the reverse order of removal, mounting the tool with the punch as shown in the figure, aligned with «B».



Utilise only new links.

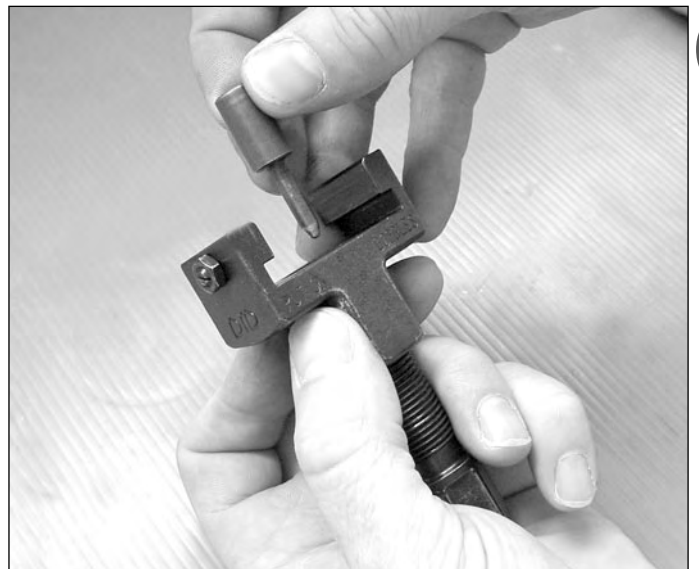

F

Mono-arm fork pin removal

Remove the screw (1) on the right side of the motorcycle.
Remove the washer and push out the pin **manually**.
Support the mono-arm fork so that it does not drop to the ground.





Suspension and wheels

Bearings overhaul

If it is necessary to substitute the bearings of the mono-arm because of excessive play, operate as follows:

Remove the right and left spacer.

Remove the Seeger retaining ring on the right side of the mono-arm.

Remove the anti-dust seal on the left side.

Utilising the special tool, remove the two roller bearing units.



Special tool N. 800092860 LEFT SIDE



Mount the tool so that both roller bearings are removed.



F Utilising the special tool press on both ball bearings and extract them.

Operate in the same way for the bearings on the left side.



Special tool N. 800092860 RIGHT SIDE



Extract the spacer from the right side.





Suspension and wheels

Check the condition of both bearing seats and the seat of the spacer.

If the spacer is in good condition, reinsert it onto the fork from the right side.

Assembly of the roller bearings and the roller bearing units

Pre-assemble the two roller bearing units on the left side and the two ball bearings on the right hand side utilising the special tool N. **800092866** as shown in the figure.



Special tool N. 800092866



Utilising a press fit the bearings and the roller bearing units (see figure).

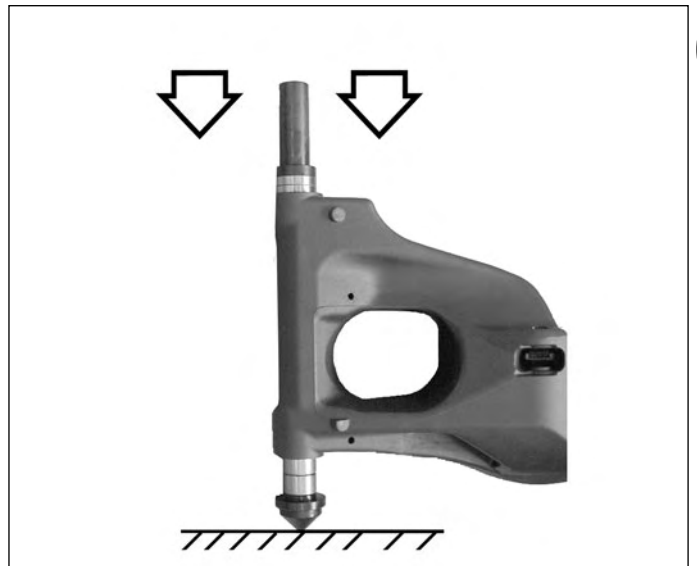

F

REAR WHEEL HUB

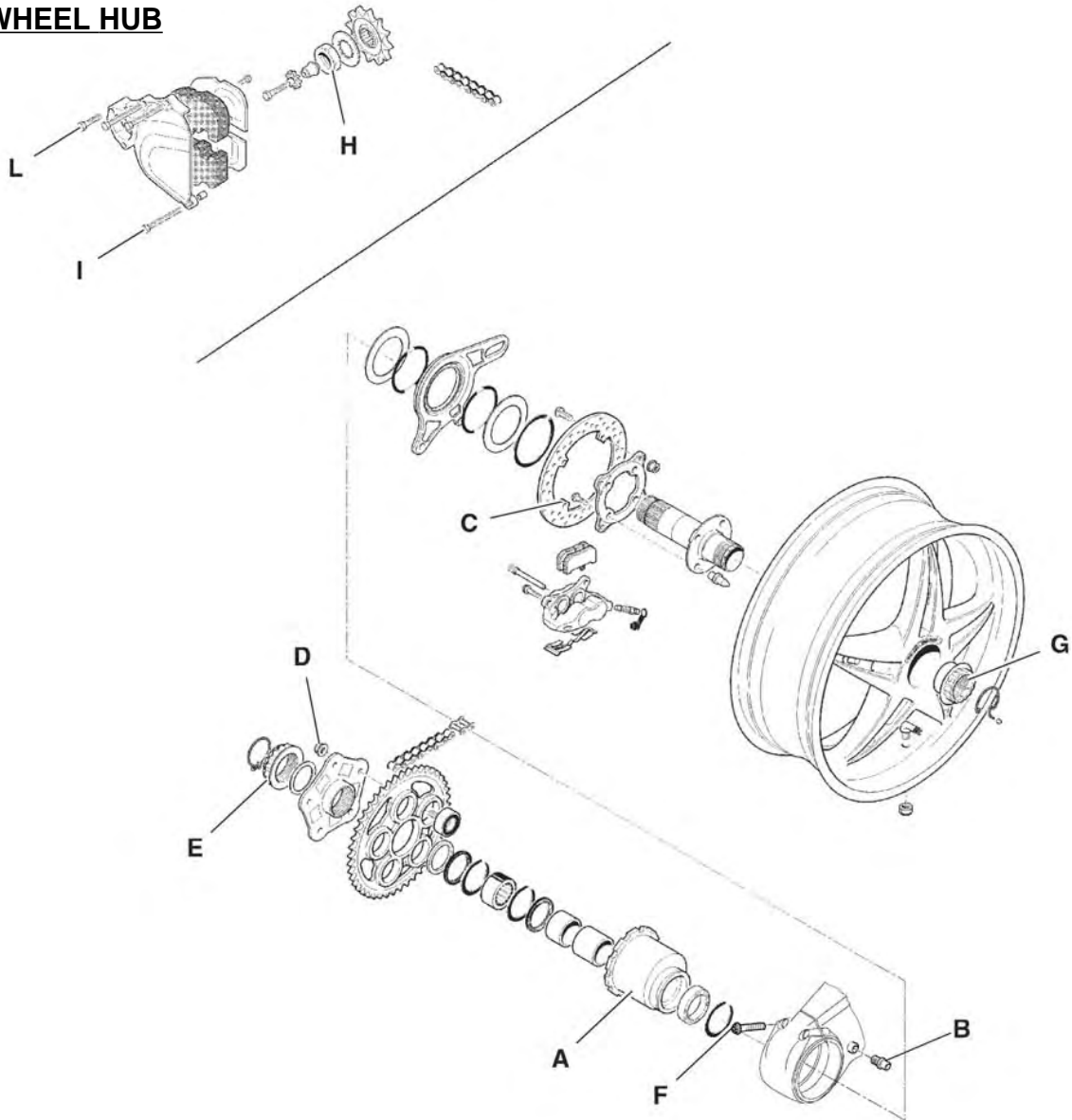

		A	B	C	D	E	F	G	H	I	L
Torque pressure	N-m		30 ÷ 35	20 ÷ 22	45 ÷ 50	200÷220	28÷32	220 ÷ 240	100	25	8
	Kg-m										
	ft-lb										
Operation			270						270		

Description	BRUTALE ORO	BRUTALE S
REAR WHEEL		
Material	Magnesium alloy	Aluminium alloy
Dimensions	6,00" x 17"	6,00" x 17"
REAR TYRE		
Dimensions	190/50-ZR 17 (73 W) o 180/55-ZR 17 (73 W)	
Brand and type	DUNLOP - Sport Max D 207 Race Replica	PIRELLI - Dragon Evo MTR 22 Corsa PIRELLI - Diablo Corsa MICHELIN - Pilot Sport MICHELIN - Pilot Power DUNLOP - Sport Max D 207 Race Replica
Rear tyre pressure (*)	2.3 bar (33 psi)	2.3 bar (33 psi)

*: In the event of different make tyres being used as opposed to those advised, refer to the pressure values marked on the side of the tyre by the manufacturer.



Suspension and wheels

REAR WHEEL REMOVAL

Before checking and overhauling the rear wheel hub assembly it is necessary to carry out the following preliminary operations:

Place the motorcycle on the rear stand.

 **Special tool N. 800092642**

Remove the fixing screws of the lower silencer.



Remove the exhaust protection.



Turn the lower silencer outwards slightly.
If this movement is difficult due to residues in the area of connection to the compensator, clean the part applying lubricant / **WD-40** unblocking spray.
Rotate the silencer in a clockwise or anti-clockwise direction alternatively to allow the lubricant to seep through.



F



Suspension and wheels

Remove the retaining ring (1) of the wheel nut.
Remove the rear wheel by removing the polygonal nut,
using the following tools:

 **Torque wrench**
55 mm polygonal spanner

Utilising a torque wrench, slacken the
rear wheel nut.

 **The polygonal fixing nut of the rear wheel
has a left hand thread. To slacken the nut
it is therefore necessary to turn the
torque wrench in a clockwise direction.**



F Remove the rear wheel nut.

N.B. **When reassembling, tighten the rear
wheel nut to the prescribed torque pressure.**

 **Rear wheel nut torque pressure: 220 ÷ 240
N•m**



Remove the rear wheel taking care to not hit the silen-
cer connecting plate.

N.B. **If this operation is too difficult to carry out,
remove the silencer connecting plate
completely before removing the wheel.**



After having effectuated the rear wheel removal, support the motorcycle with a lift as shown in the figure. Remove the rear stand.

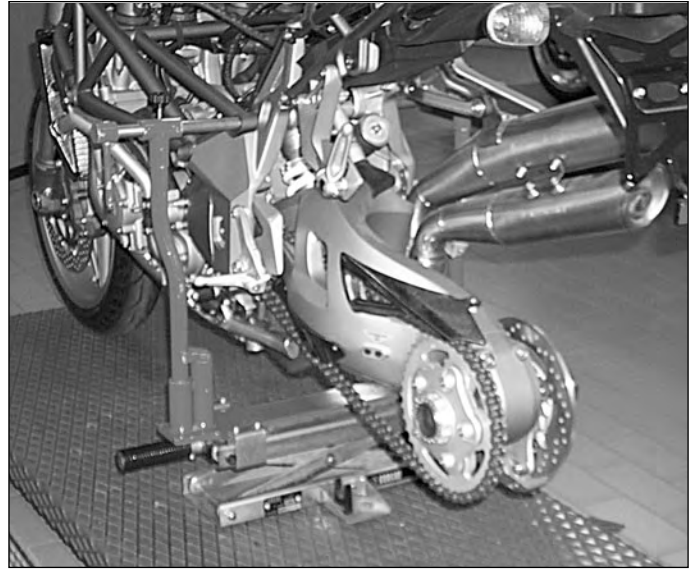

Remove the safety ring (1) of the crown flange-fixing nut.

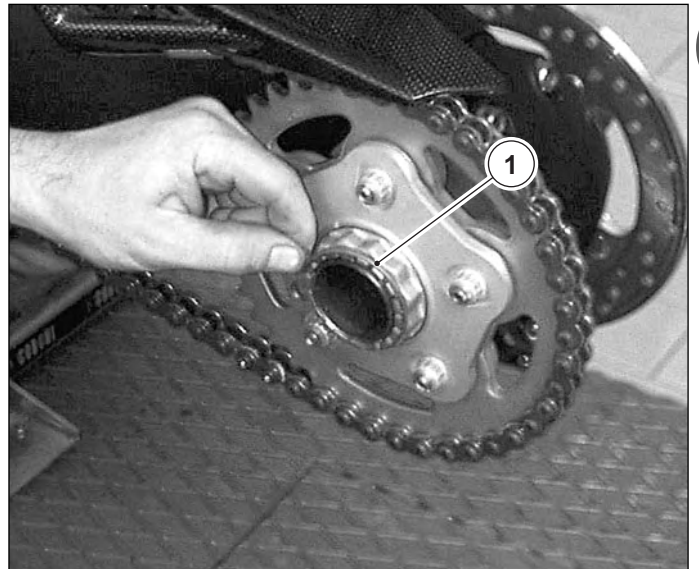

Slacken the nut of the flange by rotating it in an anti-clockwise direction as shown in the figure. Utilise the following tools:

-  • **Torque wrench**
- **55 mm polygonal spanner**

Remove the brake caliper as described in chapter H "Brakes".



Slacken the fixings (1) of the wheel hub.

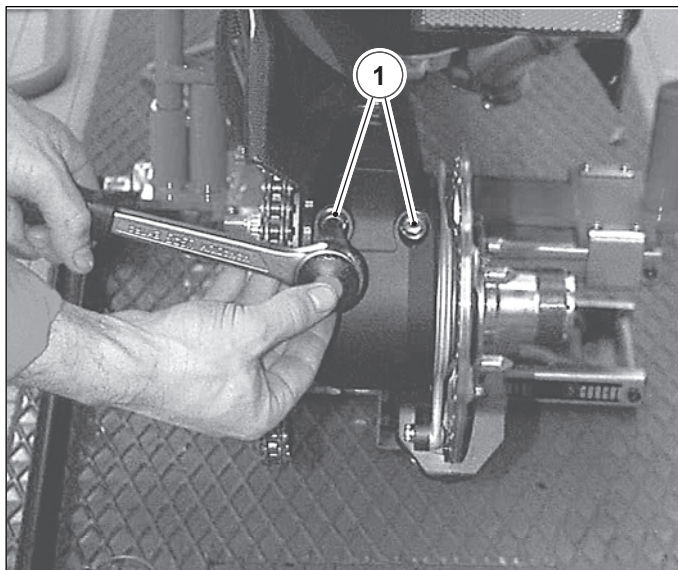

F With the special spanner mounted on the extension tube, pull forward the eccentric adjuster and release the chain from the crown wheel.

Special tool:
Eccentric adjuster spanner N. 800092854
Spanner extension N. 800092855

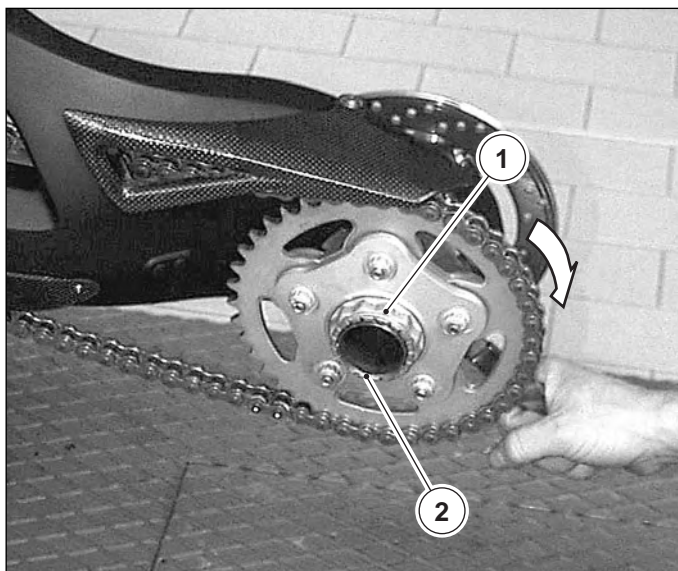

When adjusting the tension of the chain it is necessary to carry out the motorcycle set up adjustment. See “Motorcycle set up adjustment” in this chapter.

Crown wheel assembly removal

Remove the wheel spindle nut (2) previously slackened and the spacer ring (4) underneath. Remove the crown wheel assembly (3) by manually pulling the assembly outwards.



Make sure that a spacer ring is present between the flange and the hub.



Do not hit the crown wheel with metal objects.

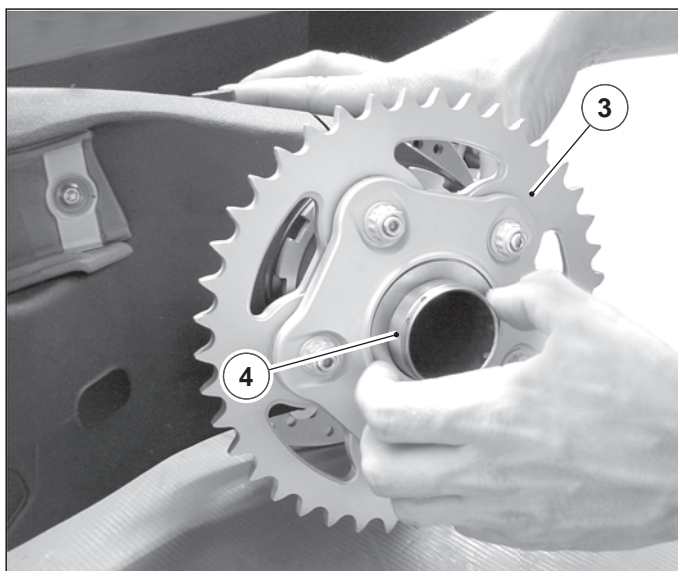

Wheel spindle removal

Remove the wheel spindle complete with the brake disc, extracting it from the right side of the motorcycle as shown in the figure.

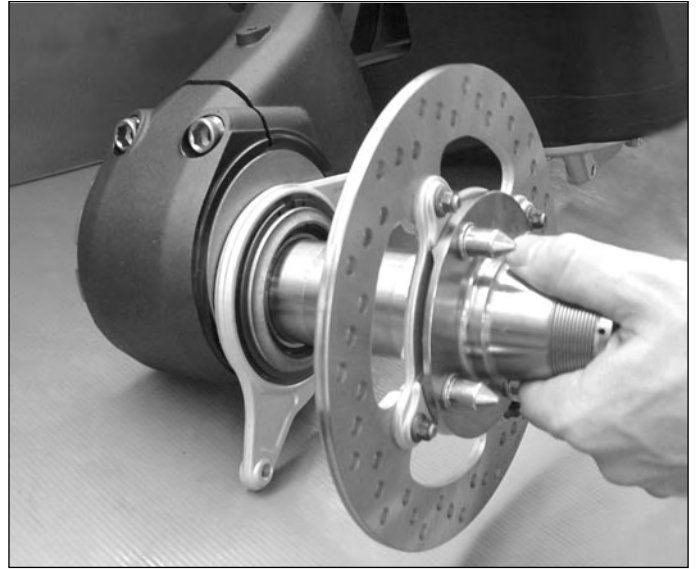

Pincer carrier flange removal

Remove the Seeger retaining ring (1), the spacer ring (2), the flange (3) and the spacer ring underneath.

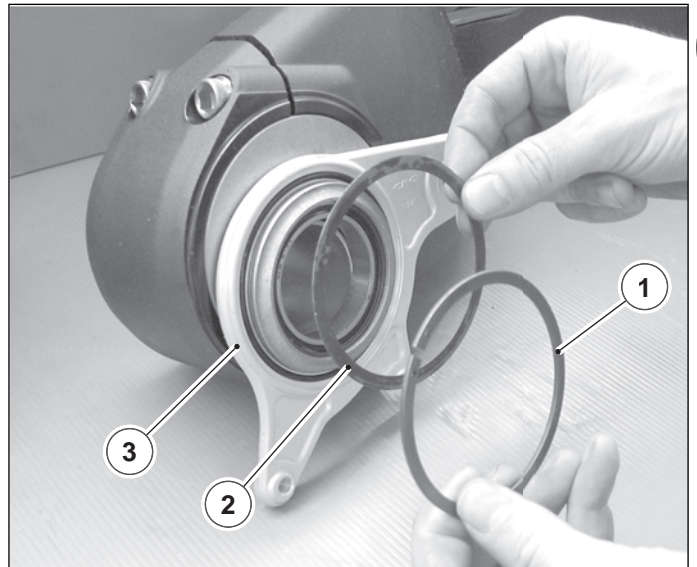

Wheel hub disassembly

Extract the wheel hub from the left side of the fork. Carefully wash all parts. Check the condition of the roller bearing and the ball bearing. If there is excessive play (even only one of the bearings) or chamferings during rotation, substitute the wheel hub, complete with bearings with a new unit.



If only one bearing is worn, substitute the complete unit. Never substitute one bearing only.





Suspension and wheels

For normal maintenance, remove the two internal spacers (wheel spindle seat), wash the roller bearing units, dry them and grease them.
Check the condition of the ball bearings.



Recommended grease:

- Agip GR MU3 (Brutale ORO)
- Molykote BR2 PLUS (Brutale S)



F Caliper holder pin

N.B. Unscrew the caliper holder pin only if it is damaged.

When reassembling apply the prescribed type of Loctite and tighten to the prescribed torque pressure.



Recommended thread-locking fluid: Loctite 243



**Caliper holder pin torque pressure:
30 ÷ 35 N•m**



Wheel spindle unit check

Check the condition of the wheel drive engagement splines.
If it is worn, substitute as follows.





Suspension and wheels

After having heated them, remove the four brake disc carrier flange fixing screws (1) mounted with **Loctite 270**.

Remove the flange.



Recommended thread-locking fluid: Loctite 270

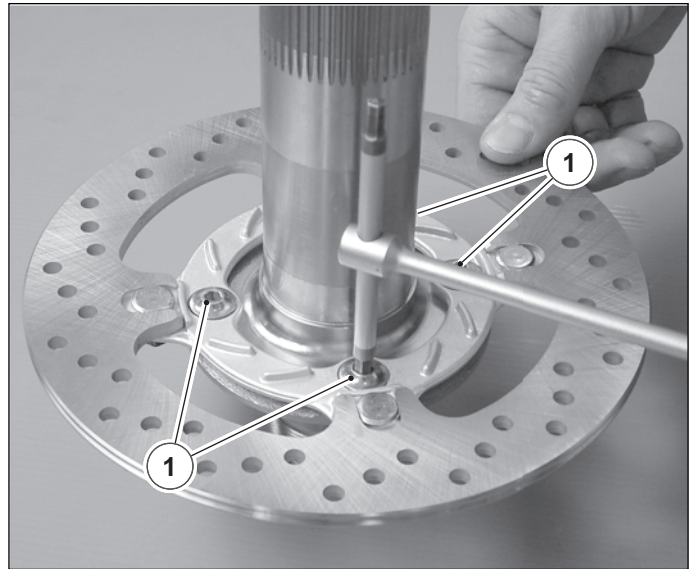

Check the extra-smooth parts of the wheel spindle for wear (A).

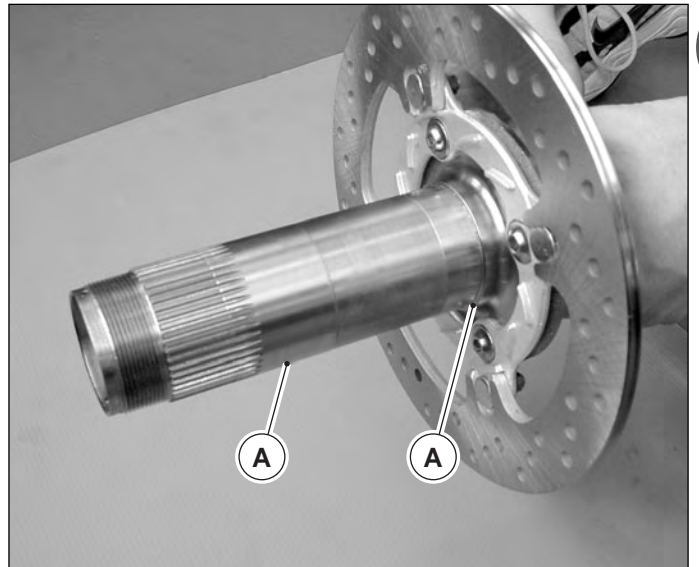

F

Utilising a press with an adequate punch for both the removal and assembly of the pins of the wheel drive engagement.

When assembling, apply force on the crown of the peg not on the point. (see figure).

Assemble the brake disc carrier plate by tightening the screws to the prescribed torque pressure and then apply **Loctite 270**.



Recommended thread-locking fluid: Loctite 270



Brake disc carrier plate screw torque pressure: 20 ÷ 22 Nm

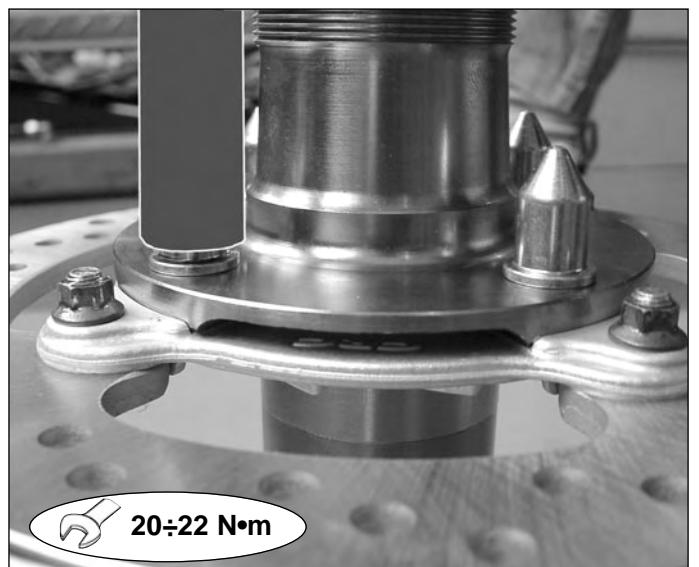



Suspension and wheels

Check

Evaluate the wear condition of the crown wheel. If it is badly worn, effectuate a substitution with a new part.

Slacken the five Silentblock and if necessary substitute them.



F When reassembling, grease the area that comes into contact between the flange and the crown.

 **Do not apply grease to the threads of the pins.**

Tighten the five nuts to **45 ÷ 50 N•m** as shown in the figure.



Reassembly wheel hub

Lightly grease the wheel hub.

Introduce the hub to the fork from the left side of the motorcycle and push it in.

Screw in the two screws on the fork without tightening.



Recommended grease: Agip Grease 30

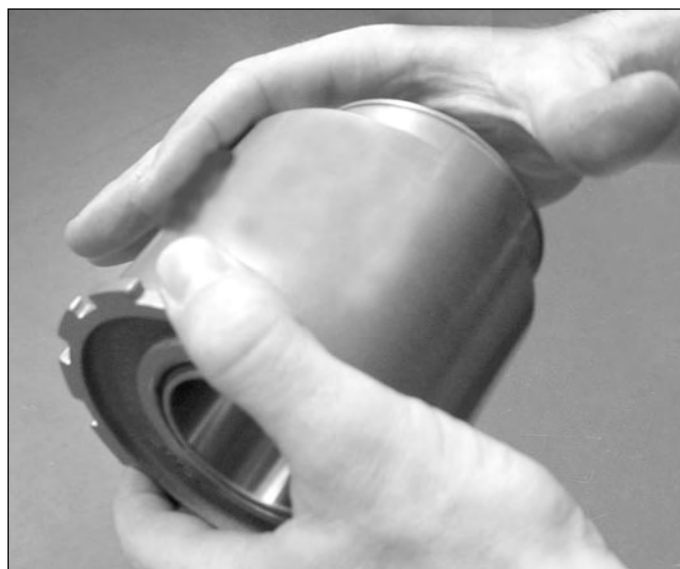



Suspension and wheels

To assemble the brake caliper-carrying flange, carry out the following operations:

Grease the O-rings and insert them into their respective seats on the flange.

Assemble the rear spacer ring in contact with the hub, then the brake caliper-carrying flange (1), the second spacer ring and the Seeger retaining ring (1).

It is important to ensure that the Seeger retaining ring is inserted around the whole circumference of the seat.

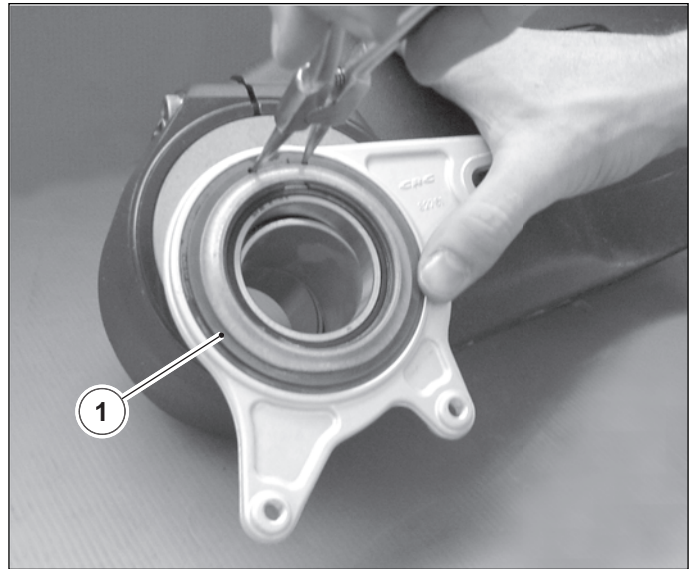

Introduce the first spacer.

Grease and insert the roller bearing unit.

Assemble the second spacer (the ground one).



Recommended grease: Agip GR SM

(If the recommended grease cannot be found, it is possible to use a product having the following characteristics:

- Lithium grease and molybdenum disulphide
- NLGI consistency: 2
- Dropping point ASTM: 190° C
- Base oil viscosity at 40° C: 160 cSt)

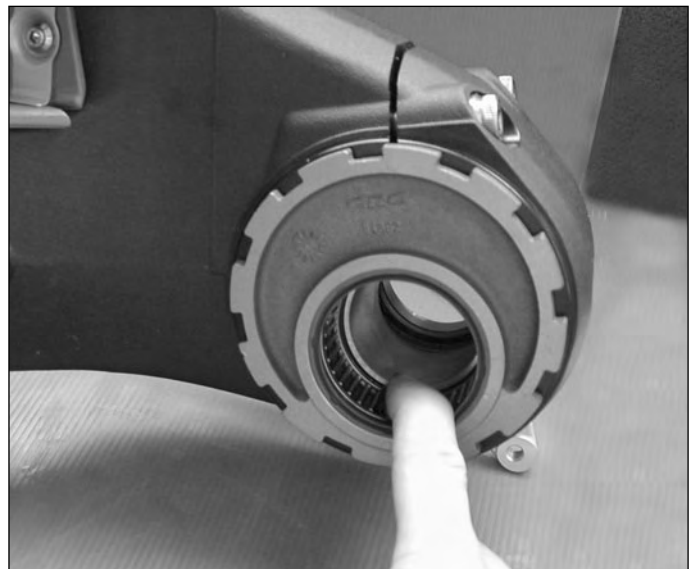

Reassembly rear wheel pin

Grease the wheel pin and introduce it carefully into the hub.

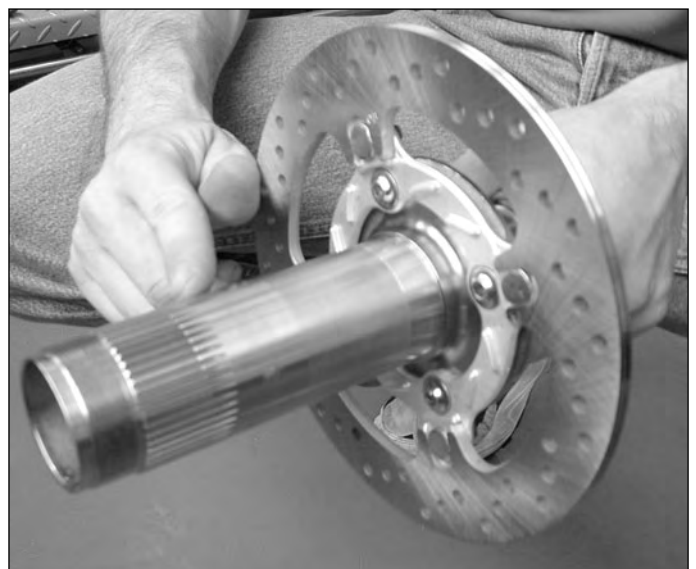



Suspension and wheels

Insert the spacer ring illustrated in the figure onto the wheel pin.
Insert the crown wheel assembly, the second spacer ring and the wheel pin fixing nut.
Tighten the nut to the prescribed torque.

 **Rear wheel nut torque pressure:**
200 ÷ 220 N•m

Assemble the retaining ring.



F Chain tension adjustment

Utilising the special tool, screw the eccentric adjuster forward so that the chain can be inserted.
Mount the chain onto the crown wheel and adjust the eccentric adjuster until the chain is taught but not tight (see the information printed on the chain adjustment nameplate).

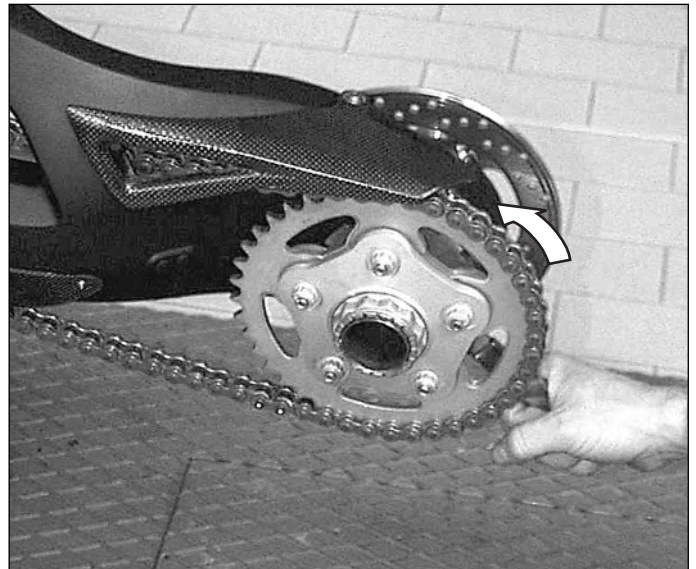

Tighten the hub screws to the prescribed torque pressure. Do not go past this limit.

 **Exceeding the prescribed tightening torque may seriously damage the rear wheel hub and endanger the driver's safety.**

 **Wheel hub screws torque pressure: 28 ÷ 32 N•m**

 **When adjusting the tension of the chain the motorcycle set up adjustment must be carried out beforehand. See "Motorcycle set up adjustment" in this chapter.**

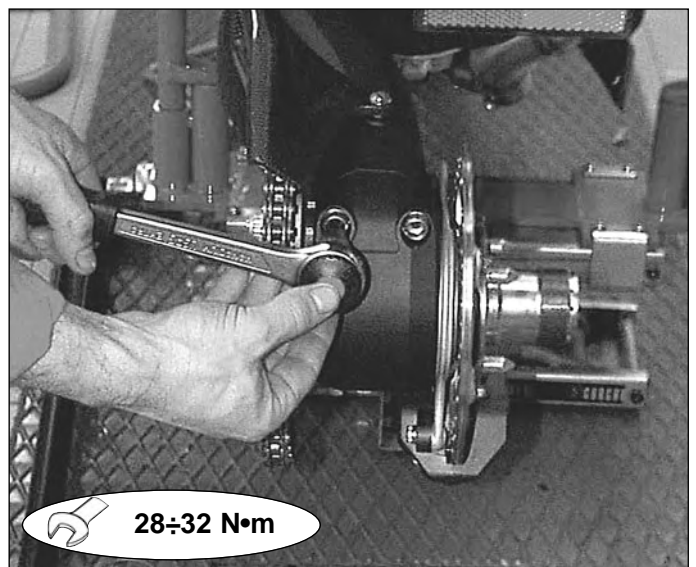



Suspension and wheels

Rear wheel assembly



In the case of substitution of the rear tyre it will be necessary to effectuate the balancing of the wheel before assembling it. Follow the instructions indicated in page 62.

Insert 1st gear.

Reassemble the rear wheel.

Tighten the wheel axis nut to the prescribed torque pressure.



Rear wheel nut torque pressure: 220 ÷ 240 N•m

Insert the retaining ring.



Pinion wheel removal

Remove the male connector holder (1) from the support plate fixed to the engine casing.

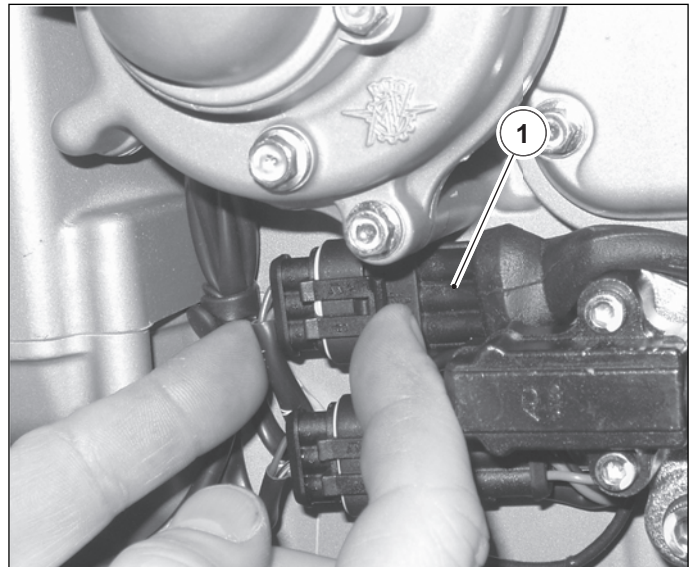

Remove the screw (1) of the clutch control cylinder and the three screws (2) of the pinion wheel cover.

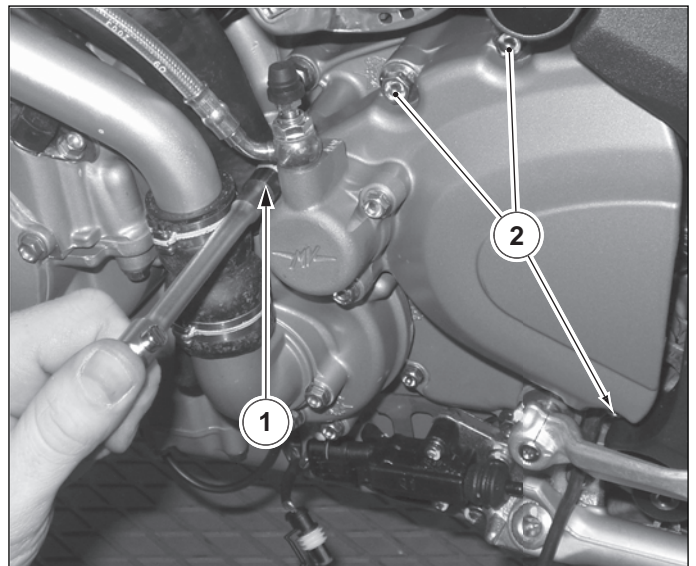

F

Remove the cover being careful to not extract the clutch control rod (it must remain inserted in the engine) and be careful to not lose the two centralising bushes indicated in the figure .

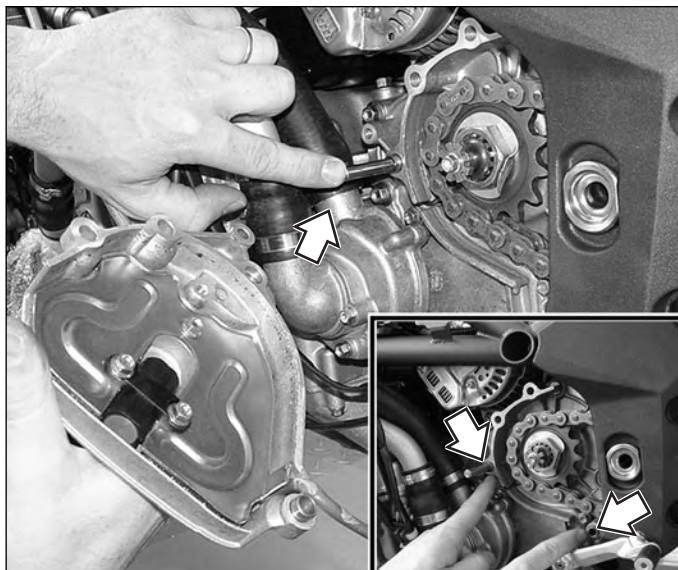

F Straighten the metal tongue with a flat-head drift and hammer.
Unscrew the pinion wheel retaining nut.



Be careful to not hit the timing wheel situated on the extremity of the pinion shaft during this operation.

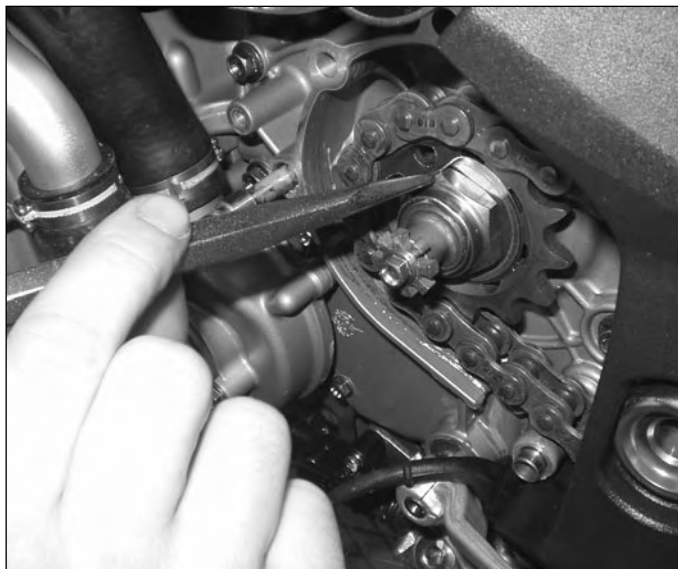

Slacken the chain (see page 48), bring it forward and slide it off the pinion wheel.

Effectuate this operation only if the pinion wheel has to be substituted.

If the pinion wheel and crown wheel assembly have to be substituted, it is advisable to operate by cutting the chain (see page 40), to facilitate the operation.



For reassembly, insert the pinion wheel with the chain already attached.

Take a new washer, assemble it with the nut and tighten to the prescribed torque pressure utilising **Loctite 270** thread-locking fluid.

Hammer the new washer down onto the two opposite faces of the hexagon.



Chain pinion wheel nut torque pressure: 100 N•m



Recommended thread-locking fluid: Loctite 270

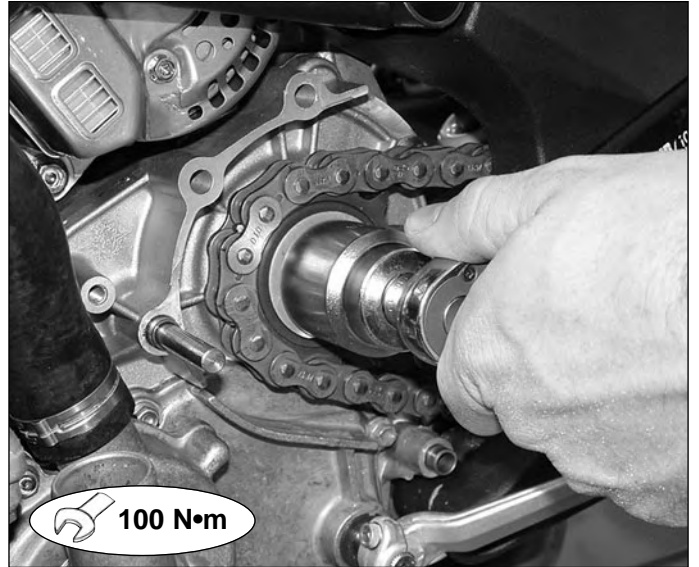

Reassemble the pinion wheel cover after having cleaned the support base.

Screw in the four screws lightly and proceed with the tightening, screwing down respectively on the three screws M8 (1) and on the screw M6 (2).

Replace the rubber bands and reinsert the electrical connector.



Coppia di serraggio (Viti M8): 25 N•m
Coppia di serraggio (Vite M6): 8 N•m

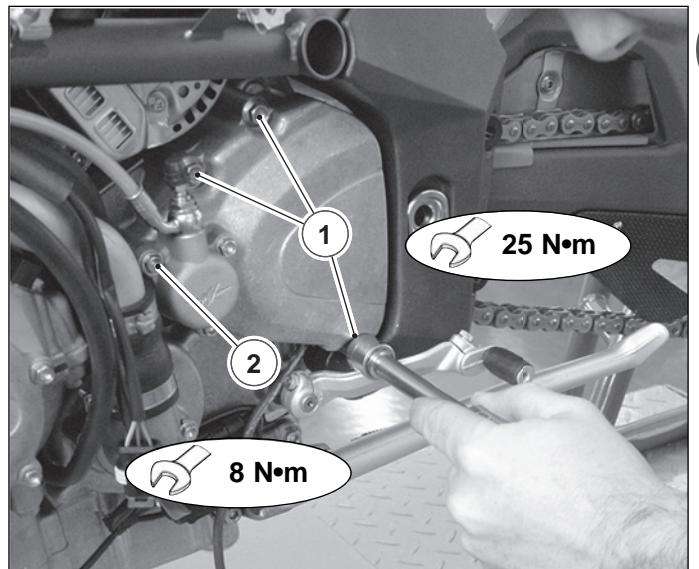

MOTORCYCLE SET-UP ADJUSTMENT

This operation must be carried out when the motorcycle is complete and in kerb.

Place the motorcycle on the rear stand.

 **Special tool N. 800092642**

Insert the setting-up arm (A) of the rear suspension (special tool) in its appropriate seats as shown in the figure.

 **Special tool N. 800093347**



F Press down on the seat so that the shock absorber is compressed and then let it go back into its resting position.



Measure the distance X_1 between the upper extremity of the rear stand tube and the point on the setting-up arm indicated by the arrow in the figure.

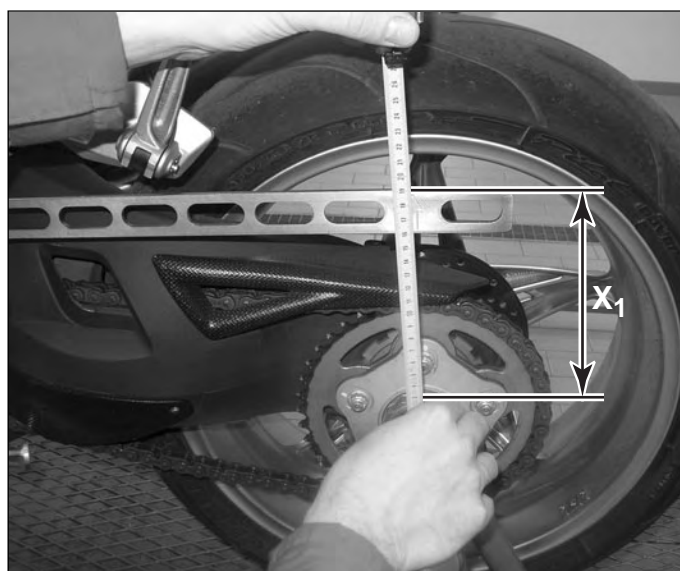



Suspension and wheels

Raise the rear part of the motorcycle by using the handle and the passenger footrest, until the full extension of the rear shock absorber is reached; contemporaneously measure the distance X_2 between the upper extremity of the rear stand and the point on the setting-up arm.

N.B. Two persons must carry out this operation.

Calculate the static slack Δ according to this formula:

$$\Delta = X_2 - X_1$$

The value of the static slack should be equal to:

- BRUTALE ORO / S (MY 03): $\Delta = 22 \text{ mm}$
- BRUTALE S (MY 04): $\Delta = 25 \text{ mm}$

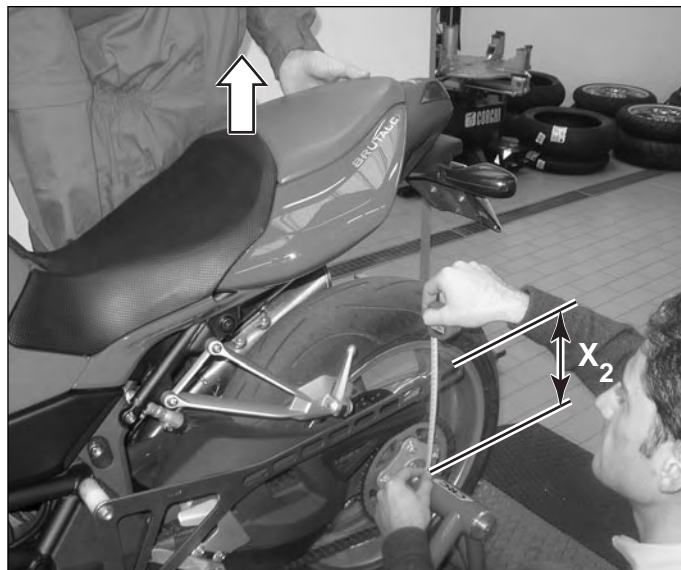

If the static slack value Δ is different from the indicated value, it is necessary to effectuate the following adjustment to the shock absorber spring.

Slacken the upper lock ring of the rear shock absorber, rotating it in the direction indicated in the figure by utilising a 75 mm key spanner.



Rotate the lower lock ring as shown in the figure, either in a clockwise or anti-clockwise direction, according to the static slack Δ value calculated.

- BRUTALE ORO / S (MY 03):

- $\Delta < 22 \text{ mm}$: Rotate in an anti-clockwise direction
- $\Delta > 22 \text{ mm}$: Rotate in a clockwise direction

- BRUTALE S (MY 04):

- $\Delta < 25 \text{ mm}$: Rotate in an anti-clockwise direction
- $\Delta > 25 \text{ mm}$: Rotate in a clockwise direction

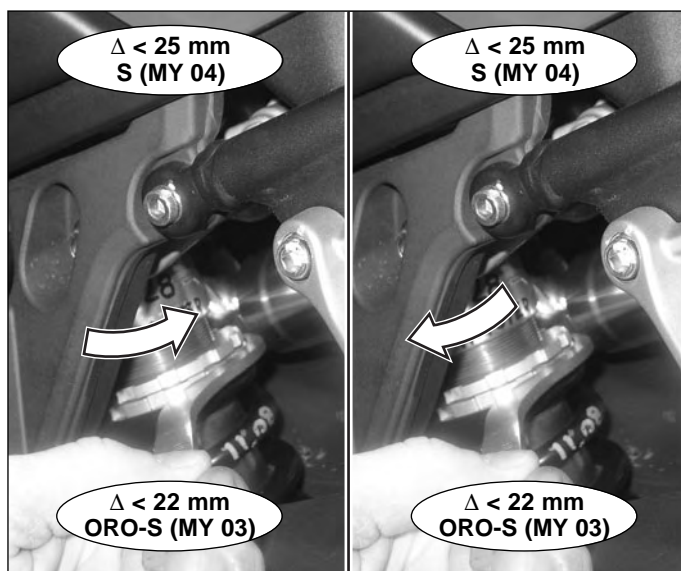

F

At the end of the spring adjustment operation, tighten the upper lock ring as shown in the figure. Re-measure the distance X_1 and X_2 and check that the static slack r coincides with the correct value. If not, repeat the spring adjustment operation until the correct measurement is reached.



F

After making the rear shock absorber adjustment, it is necessary to determine the value of the static set-up quota X .

Press down on the seat so that the rear shock absorber is compressed, after which allow the motorcycle to return to its rest position.



Measure the distance X between the upper extremity of the rear stand and the point of the set-up arm indicated in the figure.

This distance represents the static set-up quota of the motorcycle. It should be equal to the following value:

- **BRUTALE ORO / S (MY 03):** $X = 190 \text{ mm}$
- **BRUTALE S (MY 04):** $X = 200 \text{ mm}$

If the quota differs from the indicated value, it is necessary to carry out the following adjustment operation on the connecting rod of the rear suspension.

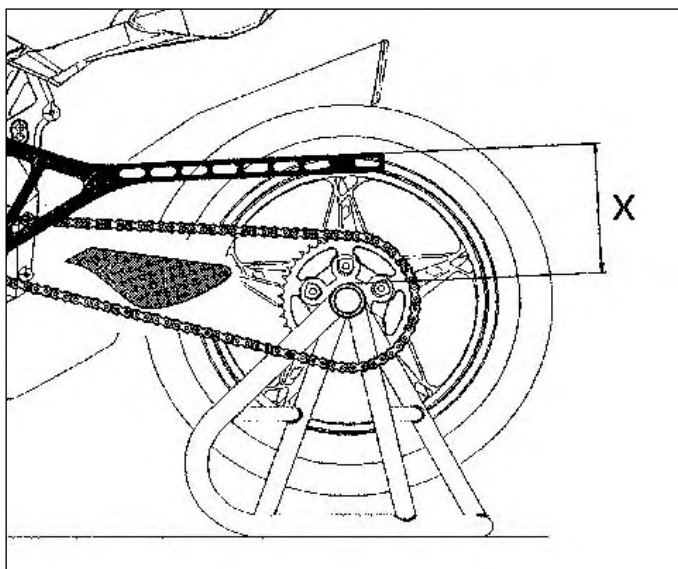

Slacken the fixing screws (1) of the semi-connecting rods of the rear suspension.

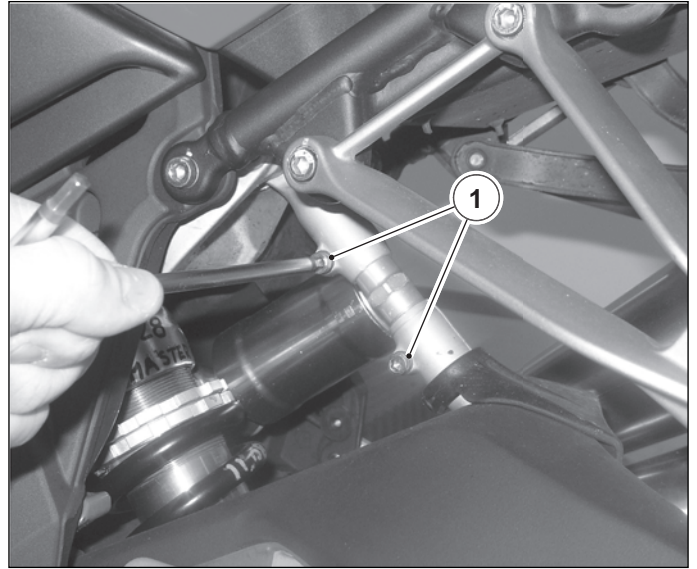

Utilising a combination wrench, vary the inter-axis between the two semi-connecting rods by adjusting the adjustment screw (1); contemporaneously, measure on the set-up rod the consequent variation of the static set-up X.

Continue the operation until the quota is equal to the following value:

- BRUTALE ORO / S (MY 03): X = 190 mm
- BRUTALE S (MY 04): X = 200 mm

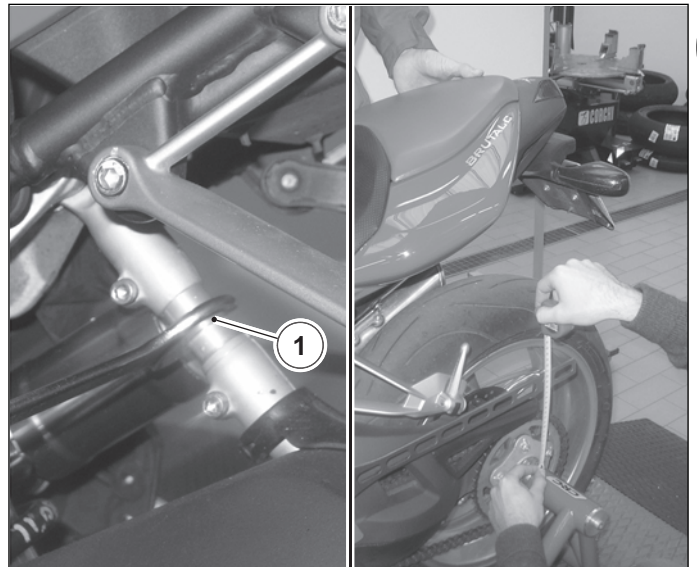

F

Tighten the fixing screws of the semi-connecting rods to the prescribed torque pressure.

 **Torque pressure: 8÷10 N•m**

After having completed the adjustment of the motorcycle set-up, it is necessary to adjust the tension of the chain.

Check also the orientation of the front headlight and if necessary effectuate the necessary adjustments. Both these operations are described in chapter B "Maintenance".





Suspension and wheels

WHEEL BALANCE CHECK

If the tyres are substituted, it is necessary to effectuate the following operations balancing and checking the wheels.

Front wheel balancing

Mount the wheel onto an adequate support similar to that shown in the figure, utilising a ground pin of **35 mm** diameter. Check the wheel. Utilising a dial gauge, check the following tolerances:



Ovalization and maximum eccentricity must not exceed **0.5 mm**.

Flatness must not exceed **0.5 mm**.



F

 When effectuating balancing on certain makes of tyres, it is necessary to refer to the yellow mark (1) present on the side of the tyre as shown in the figure. It indicates the lightest point of balancing and must be situated close to the tyre valve when the tyre is mounted onto the wheel rim.

N.B. On the side:

- Figure A: Brutale S version
- Figure B: Brutale Oro version

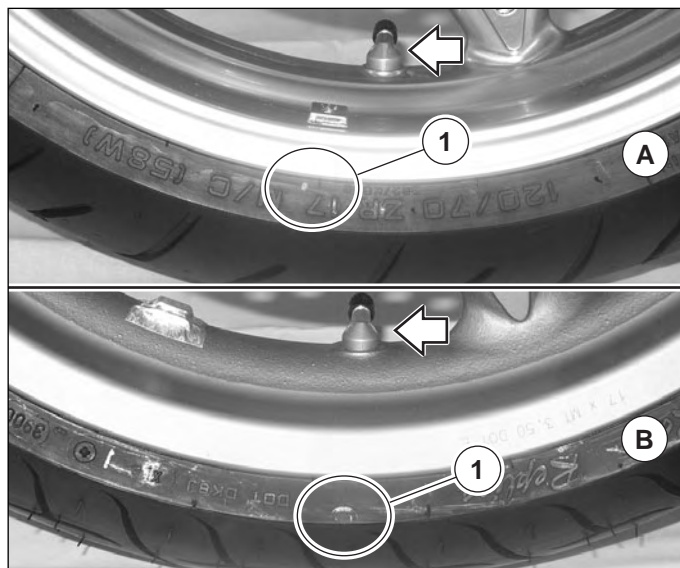

Rear wheel balancing

Before mounting the rear wheel on the appropriate tool, insert the balancing tool into the central hole of the wheel.



Special tool N. 800092865





Suspension and wheels

Insert the polygonal nut of the balancing tool from the opposite side and screw it onto the threaded part of the tool so that the tool can be fixed to the wheel.



Mount the wheel onto an adequate support similar to that shown in the figure, utilising a ground pin of **35 mm** diameter. Check the wheel utilising a micrometer gauge and check the following tolerances:



Ovalization and maximum eccentricity must not exceed **0.5 mm**.



Place the dial gauge as shown in the figure, and check the flatness.



Flatness must not exceed: **0.5 mm**.

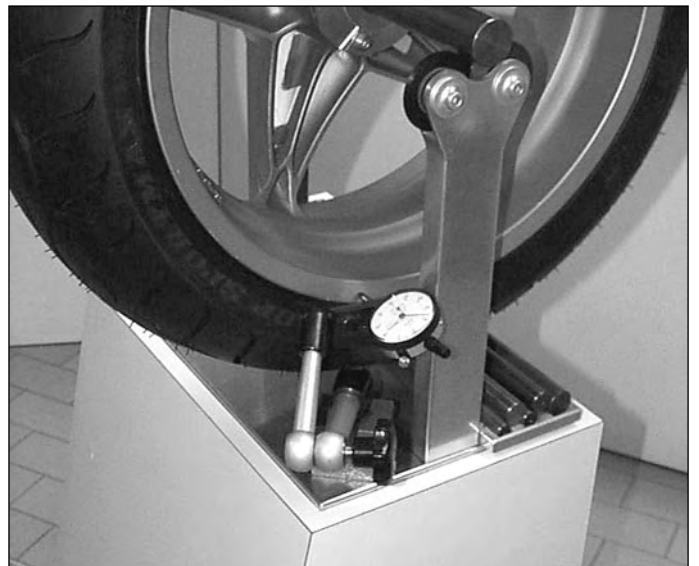



Suspension and wheels



When effectuating balancing on certain makes of tyres, it is necessary to refer to the yellow mark (1) present on the side of the tyre as shown in the figure. It indicates the lightest point of balancing and must be situated close to the tyre valve when the tyre is mounted onto the wheel rim.

N.B.

On the side:

- Figure A: Brutale S version
- Figure B: Brutale Oro version

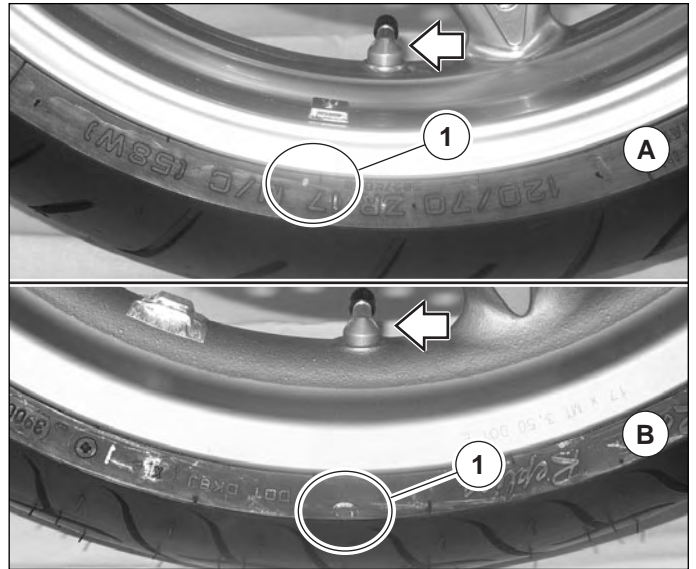

F



Frame

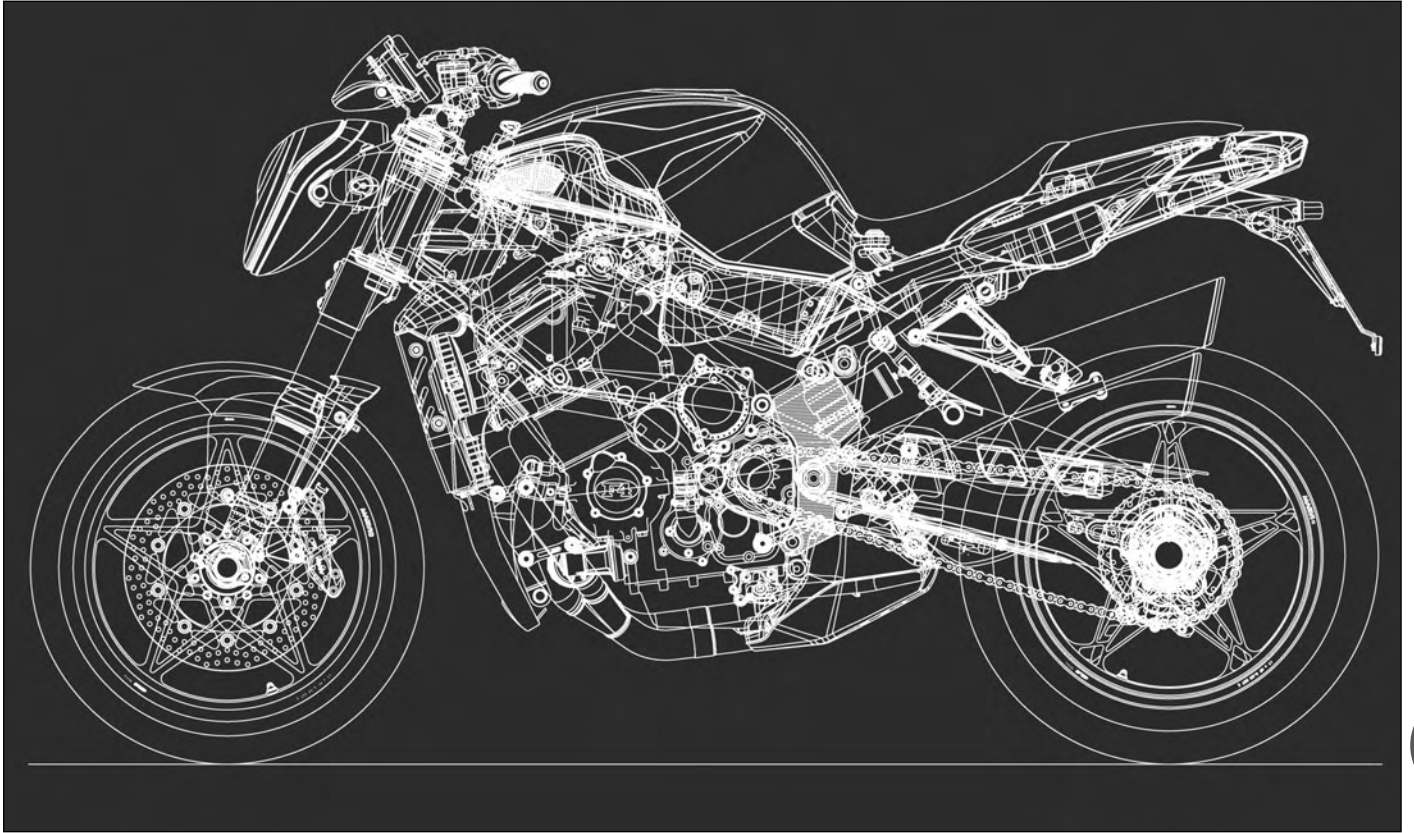

G

SECTION G

Revision 0



SUMMARY

FRAME REMOVAL PRELIMINARY OPERATIONSPAGE 3
 THROTTLE BODY REMOVALPAGE 7
FRAME DISASSEMBLYPAGE 12
FRAME CONTROL REFERENCE MEASUREMENTSPAGE 16
ASSEMBLY FRAME TO THE MOTORCYCLEPAGE 18
REAR SUB-FRAME REMOVALPAGE 22
ENGINE REMOVALPAGE 25





Frame

FRAME REMOVAL PRELIMINARY OPERATIONS

Place the motorcycle on the rear stand no. 800092642.

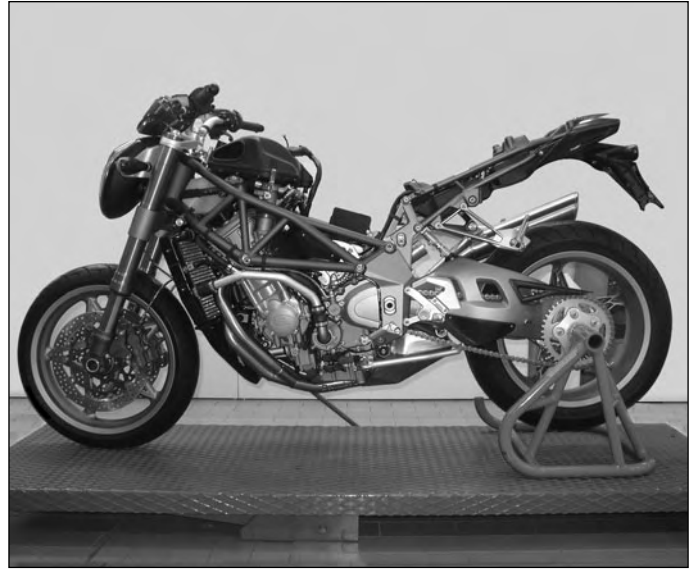

Operating on the right side, remove the sealing cover by unscrewing the two fixing nuts.

Operate in the same way to remove the left sealing cover.



Remove the components in the following sequence:

- Passenger and rider seat;
- Fuel tank;
- Air filter compartment;

the reassembly procedures of the components indicated are described in chapter C "Bodywork".



G



Frame

Utilising the lift no. 800095807 equipped with the pin no. 800095808, lift up the front part of the motorcycle.



Remove the components in the following sequence:

- Front mudguard;
- Front brake calipers;
- Front wheel;
- Water radiator;

G the procedure for removing the components indicated are described in chapter F "Suspensions and wheels", chapter H "Brakes" and chapter L "Cooling and lubricating system."



Insert the support no. 800097867, under the engine assembly taking care to position it as indicated in the figures.

Lower the motorcycle and remove the lift no. 800095807.

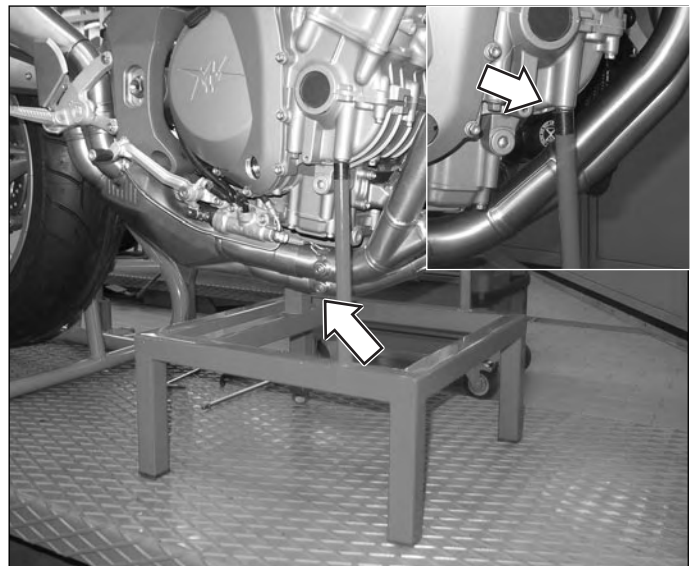



Frame

Remove the two fixing screws (1) of the front headlight on the sides.

Take care to slide the adjuster out of its seat when the headlight is removed from the support.

Before removing the front headlight, disconnect the connector (2) placed in the rear part of the headlight.

Then remove the headlight support and the instrument panel as described in chapter C "Bodywork".

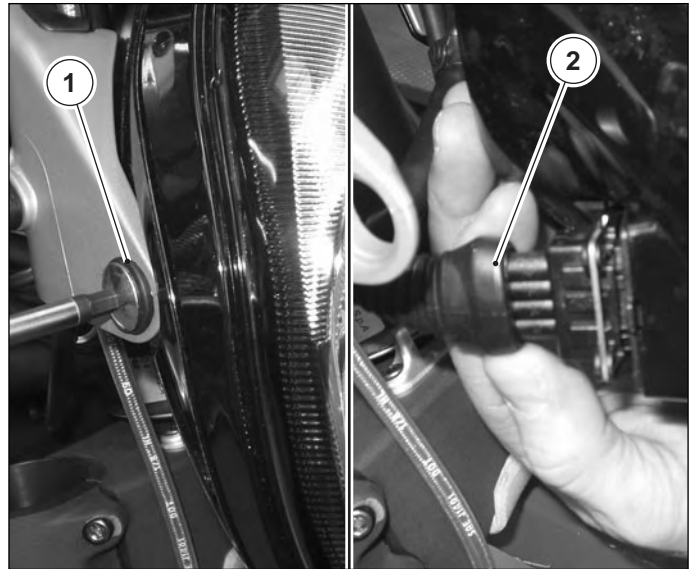

Proceed removing the front brake pump and the clutch control pump as described in chapter H "Brakes".

Free the clutch control hose (1) from the relative rubber bands on the frame.

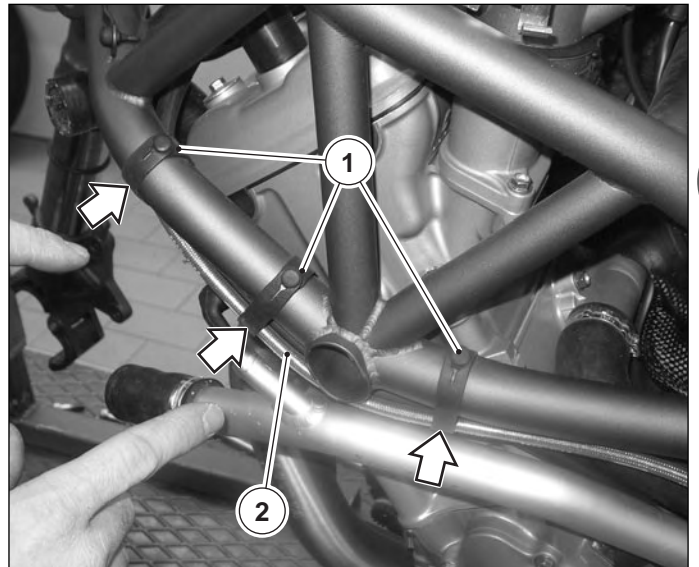

Operating on the right side, free the wiring from the bands fixing it to the frame.

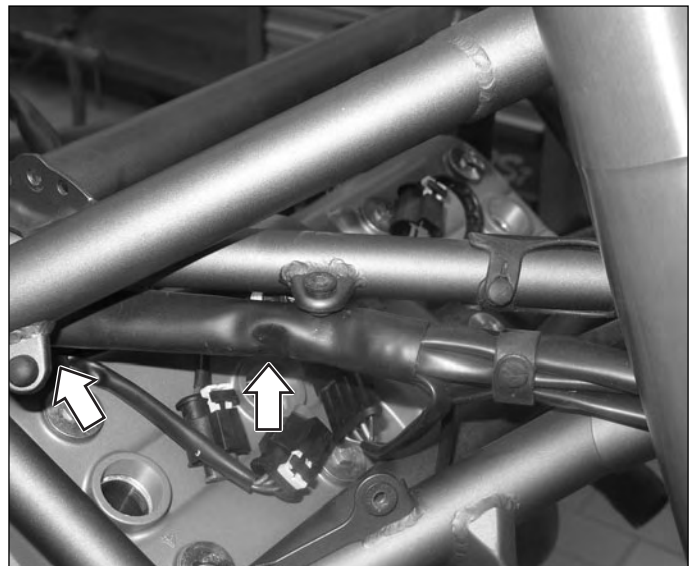

G



Frame

Protect the area around the fluid chamber with a cloth or paper.
Remove the union and discharge the clutch fluid from the system into an appropriate container.

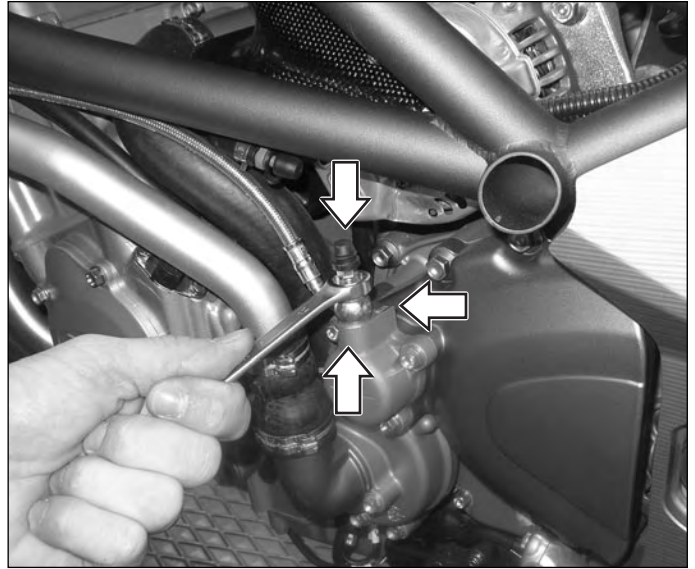

Remove the steering assembly and the relative components of the front suspension as described in chapter F "Suspensions and wheels".



Remove the ignition switch and the cooling system complete with the expansion tank as described in chapter L "Cooling and lubricating system".

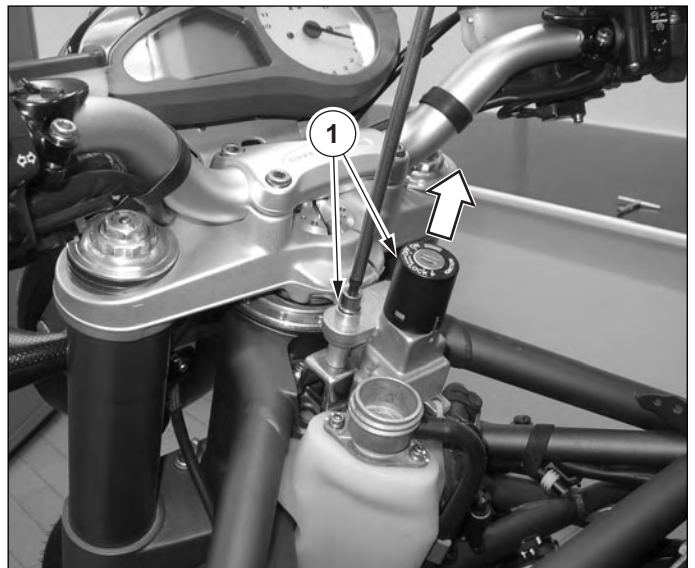

THROTTLE BODY REMOVAL

Slacken the nut (1) fixing the accelerator control wiring to the support plate of the throttle body.

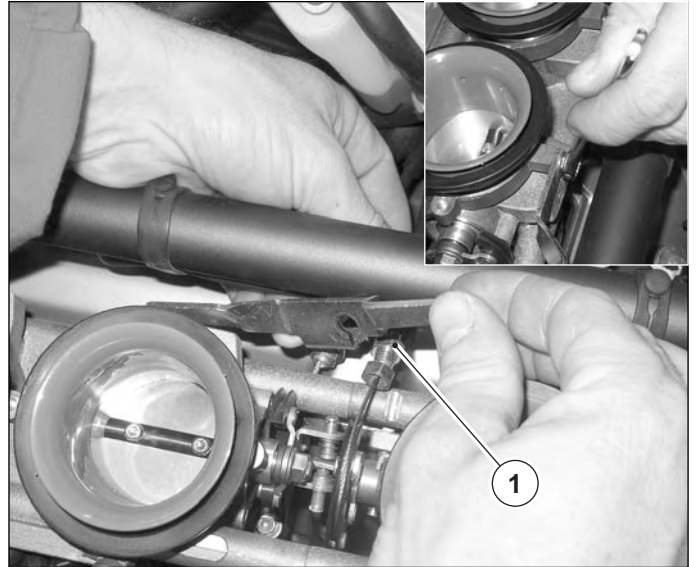

Fleet the accelerator control wiring and extract the pawl (A) of the opening wiring. Carry out the same operation on the pawl of the closing wiring.



Disconnect the connector (1) of the control of the throttle body potentiometer from the main wiring.





Frame

Slacken the bands (1) fixing the throttle body to the air intake of each cylinder.

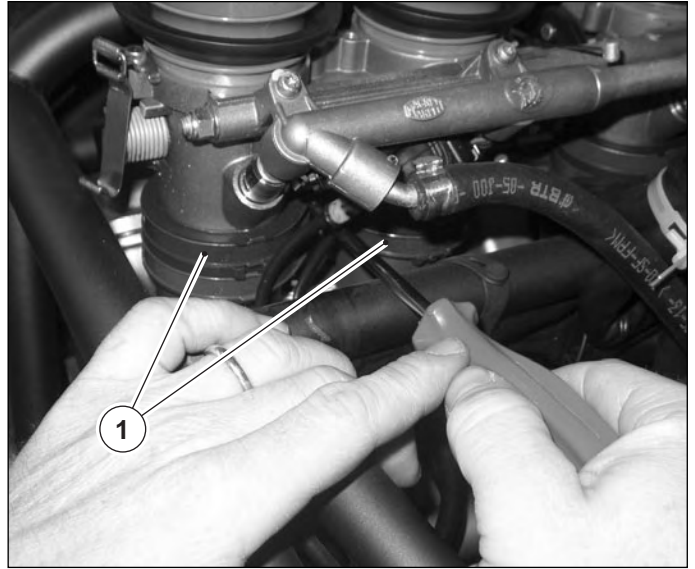

Disconnect the connections relative to the injectors of each cylinder.



Remove the complete throttle body assembly.

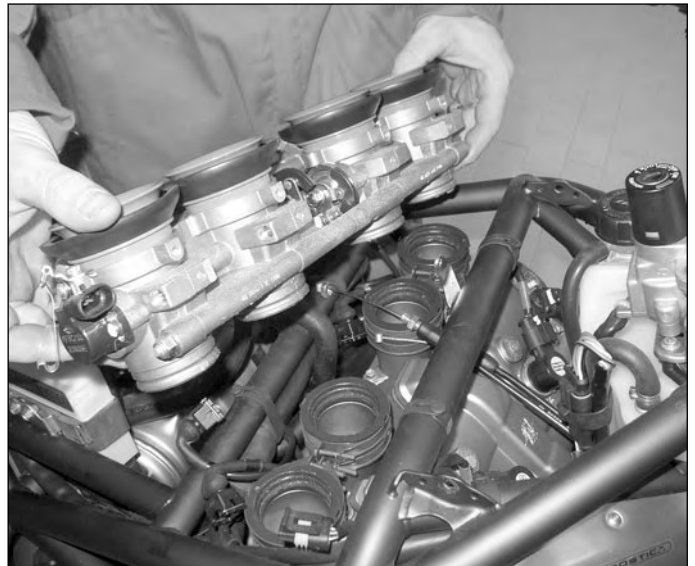



Frame

Extract the connectors from the coils.

To carry out this operation, free the secondary lock (yellow "tongue") by extracting it from its seat, then press the black "tongue" and unhook the connector.



Unscrew the earth connection on the engine head cover and free the coil wiring from the frame by removing the two fixing bands; then slide it out on the right side.



Operating on the right side of the motorcycle unscrew and remove the two fixing screws of the rear sealing protection, then free the protection.

Operate on the left side to remove the left rear sealing protection.

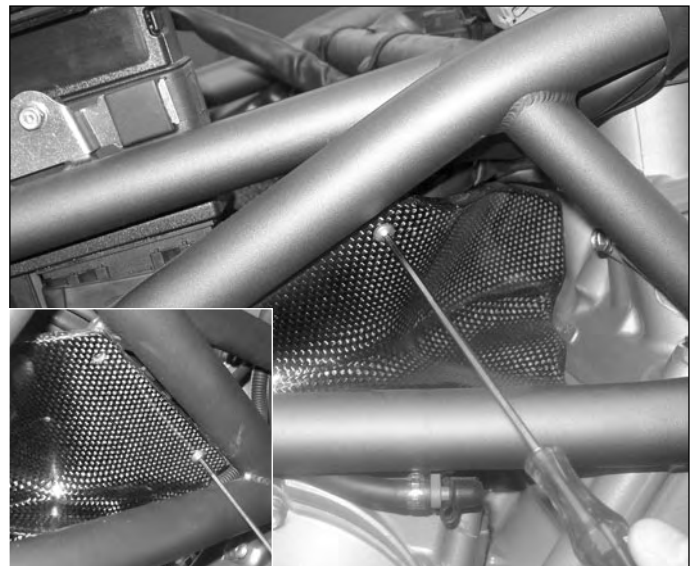

G



Frame

Operating alternatively on both sides of the motorcycle remove the supports of the tubing for checking the suction by unscrewing the screw fixing the support to the frame.

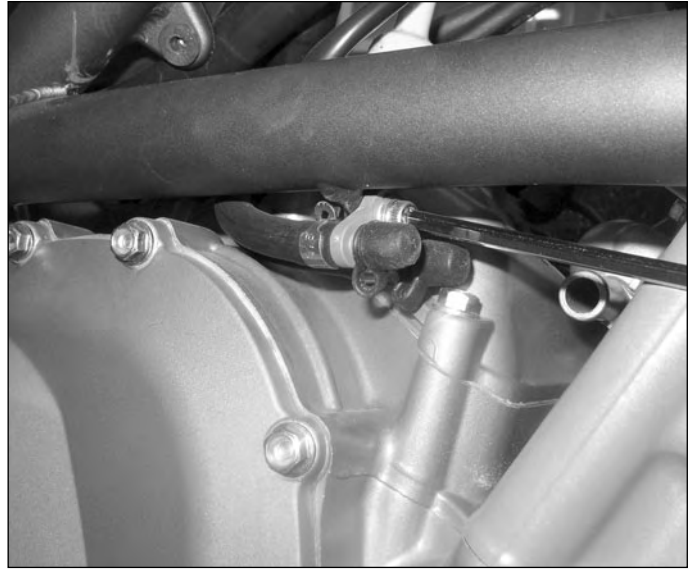

Remove the two rubber bands so to free the wiring from the frame.



Slide the CPU out from the fixing support fixed to the frame.





Frame

Slide out the main wiring and fold it backwards on the rear sub-frame.



Fix the main wiring to the sub-frame with an elastic band.



G



Frame

FRAME DISASSEMBLY

Operating in the same way on both sides of the motorcycle unscrew and remove the front screw fixing the engine cylinder head to the frame and collect the eccentric washer.

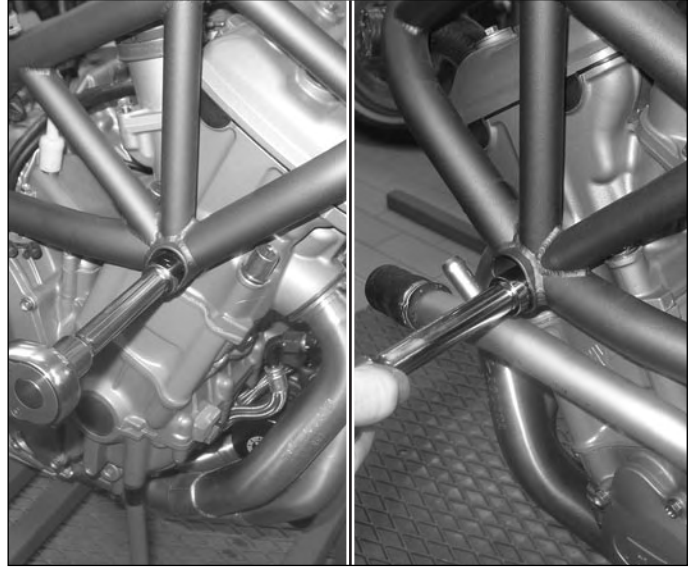

Operating on the right side unscrew and remove the rear nut fixing the engine assembly to the frame.



Operating on the left side extract the pin (1).





Frame

Remove the screws fixing the frame to the union plates from both sides.

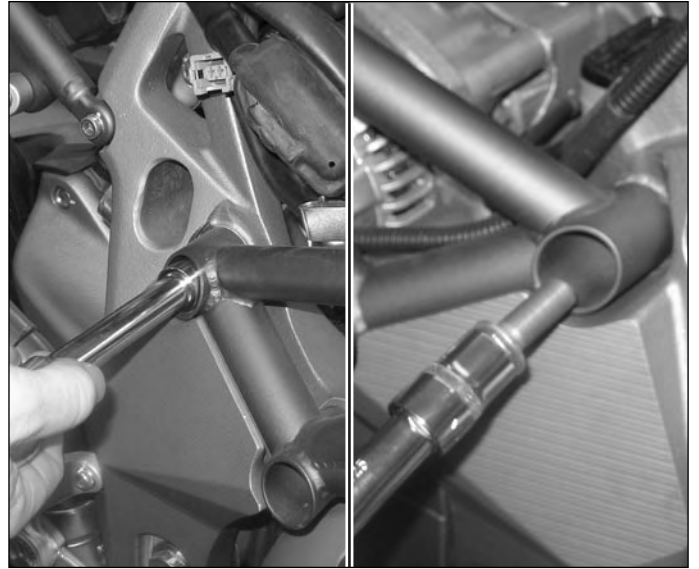

Remove the frame rotating the steering head housing upwards.



G

Frame check

Accurately clean the conical seats of the steering head housing.





Frame

Check that there are no marks or signs on all surfaces.
Check that the area shown in the figure is not deformed (as a consequence of accident damage).



Check that there are marks of evident breakages along the frame tubes.
If damage is found, substitute the frame.



Clean and examine the contacts between the frame and the engine and also between the frame and union plates.

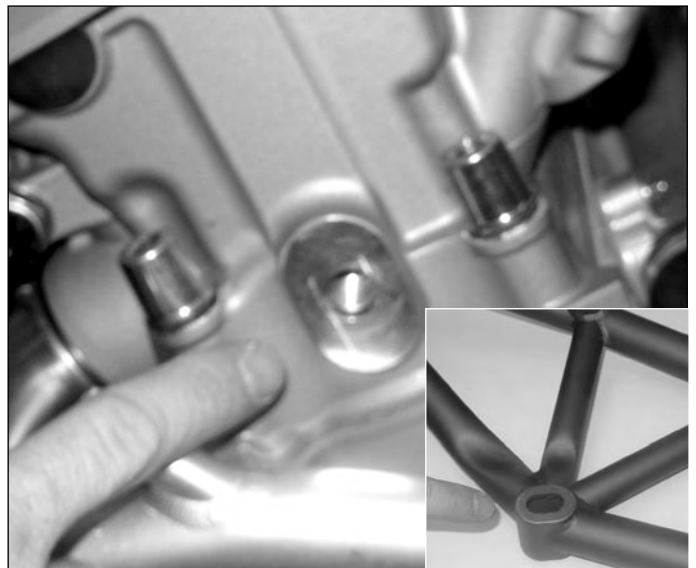



Frame

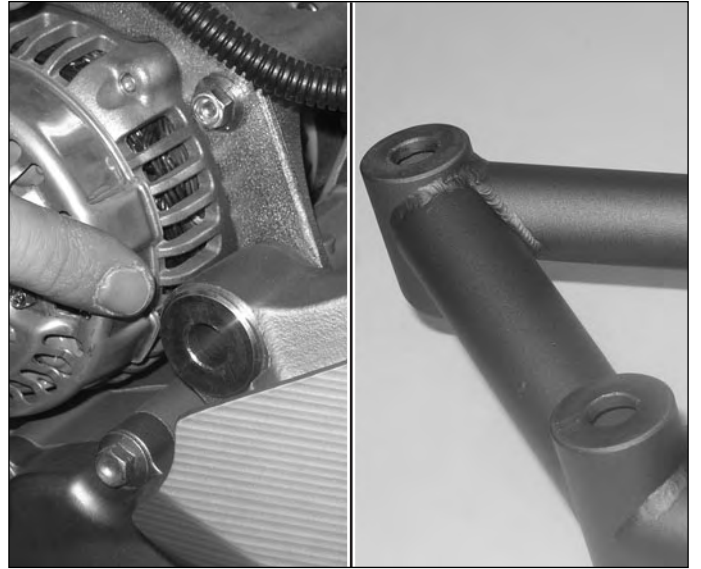

G

Steering head housing check

Check the diameter and eventual ovalisation of the steering head housing, **5 mm** from the lip of the beveling as shown in the figure.

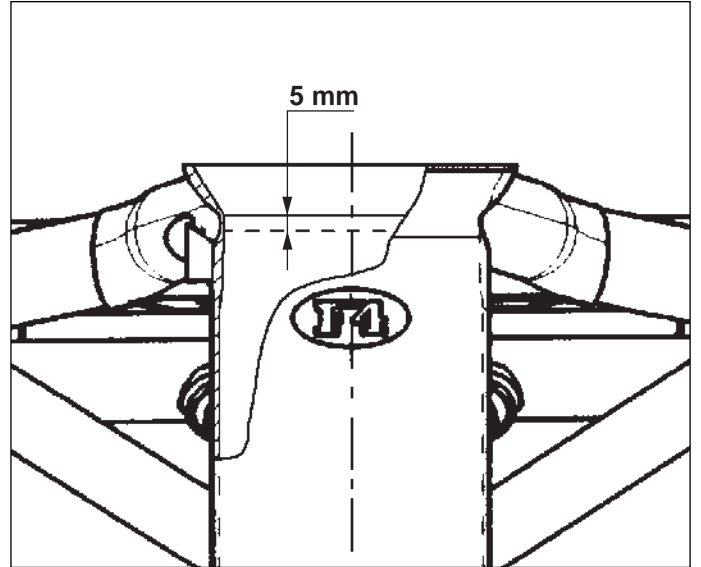

Measure the ovalisation in diverse points as shown in the figure.

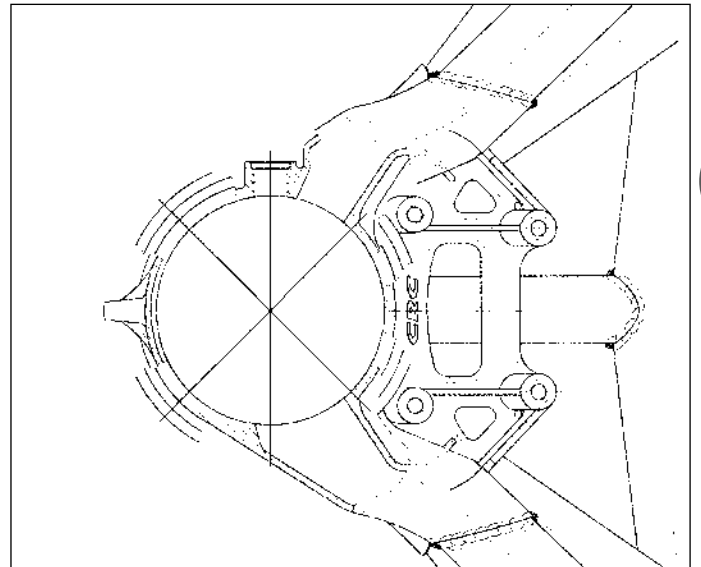

G



Frame

ASSEMBLY FRAME TO THE MOTORCYCLE

If it is necessary to substitute the frame, it is possible to recuperate various components from the old frame, such as the CPU support plate, anti-vibration rubbers and the rubber protection. These components can be mounted onto the new frame after having effectuated a thorough check on their condition.

For the stamping and the homologation labels of the new frame, contact the MV AGUSTA service centre.



Thoroughly clean the matching surfaces of the frame-engine cylinder head and frame-union plates.

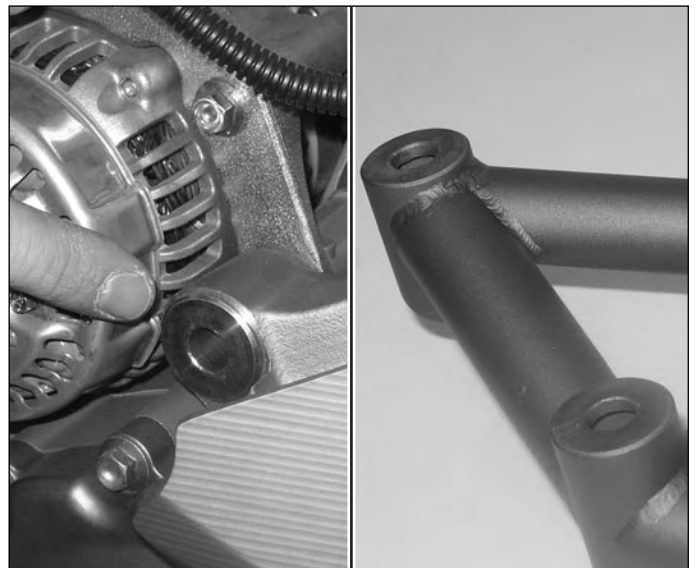
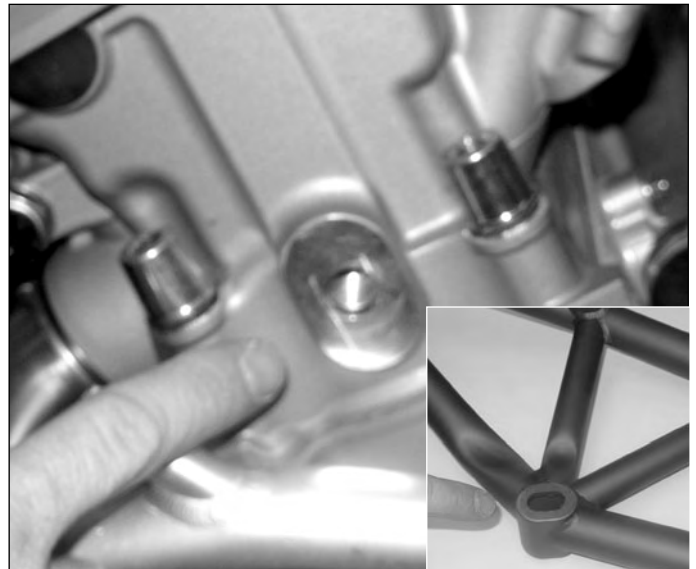



Frame

With regards to the positioning of the cables, fasteners and various wiring consult the various tables shown in the F4 Brutale ORO - S Spare Parts Catalogue (Code 800099359).

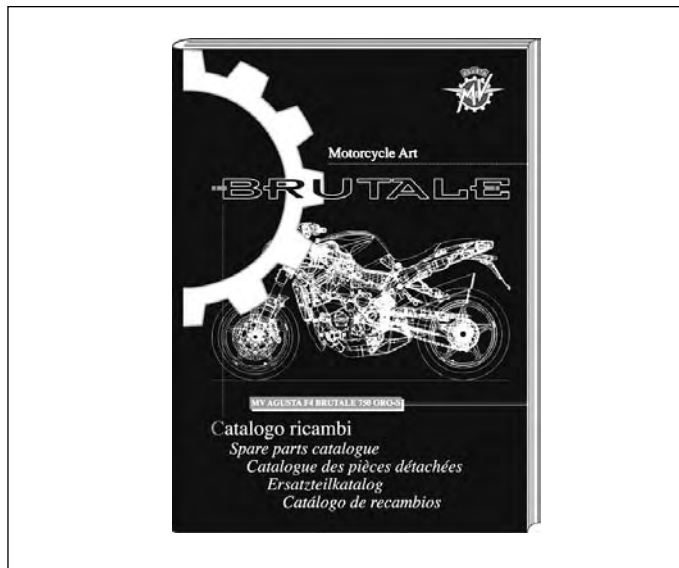



Frame

Carry out the sequence of operations of assembly in reverse order to removal for the correct assembly of the frame to the motorcycle.

Tighten the various fixings to the torque pressure shown in the following diagram.

PART.	DESIGN NO.	DESCRIPTION	DIM.	TORQUE PRESSURE	
				N·m	Kgm
①	800084869	Front engine mounting screw	M12x1.25	55/60	5.5/6.0
②	800084866	Upper engine mounting screw	M12x1.25	55/60	5.5/6.0
③	800084865	Lower engine mounting screw	M12x1.25	55/60	5.5/6.0
④	800084867	Plate – frame screw	M12x1.25	55/60	5.5/6.0
⑤	800086395	Front fork pin screw	M15x1.25	70/75	7.0/7.5
⑥	800084863	Rear suspension compensator screw	M10x1.25	50/55	5.0/5.5
⑦	8J0090426	Plate- upper sub-frame fixing screw	M8x1.25	24/28	2.4/2.8
⑧	8J0090426	Plate- lower sub-frame fixing screw	M8x1.25	24/28	2.4/2.8

The tightening of the engine mounting screws and the plates ①②③④⑤⑥ is effectuated with the motorcycle resting on its wheels and the engine hanging from the frame.

The tightening of the rear sub-frame screws ⑦⑧ is carried out by letting the sub-frame drop into position by its own weight.

Utilise “AGIP GREASE 30” for the screws.



Frame

REAR SUB-FRAME REMOVAL

After having carried out the removal of all the necessary components described in the previous paragraph, remove the connector (1) on the generator.

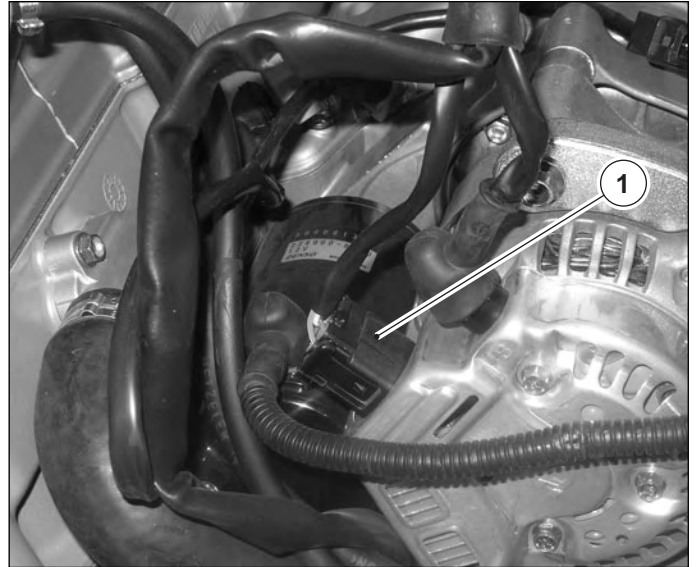

Unscrew and remove the nut fixing the generator wiring to the system.

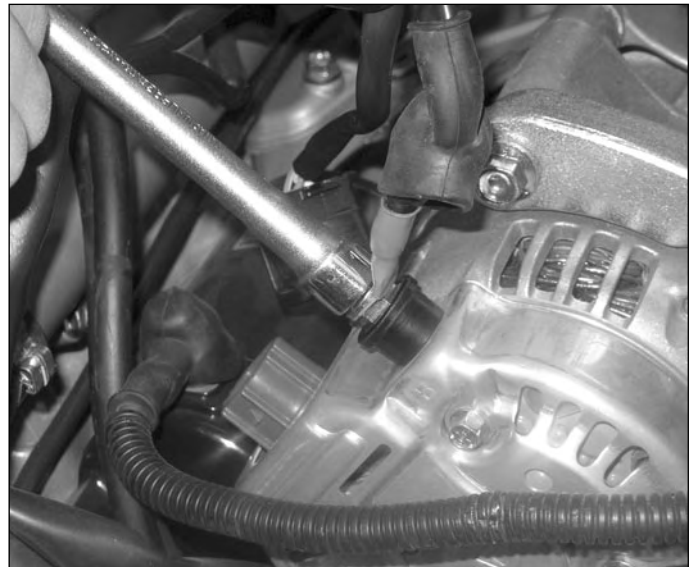

Unscrew and remove the nut fixing the starter motor wiring to the starter switch.

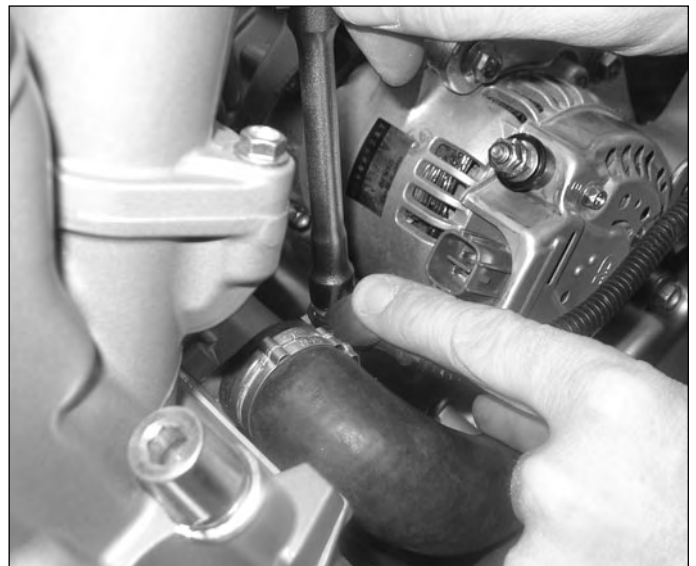



Frame

Unscrew and remove the screw fixing the engine earth cable to the fixing support of the rear brake fluid tank.



Once the wiring has been freed and collected as shown in the figure, it is possible to remove the rear sub-frame.



Unscrew and remove on both sides the two lower screws fixing the rear sub-frame to the union plates taking care to recuperate the nuts.

Unscrew and remove the two upper fixing screws taking care, in this case also, to support the sub-frame and recuperate the nuts.



G



Frame

At this point it is possible to remove the complete sub-frame assembly from the motorcycle.



Rear frame unit assembly

Carry out the operation of reassembling the rear sub-frame on the motorcycle in the reverse order of removal, taking care to tighten the fixing screws to the prescribed torque pressure.



Rear sub-frame fixing screw torque pressure: 24÷28 N•m





Frame

ENGINE REMOVAL

Side stand removal

Operating on the left side of the motorcycle, unscrew and remove the two fixing screws of the side stand switch.

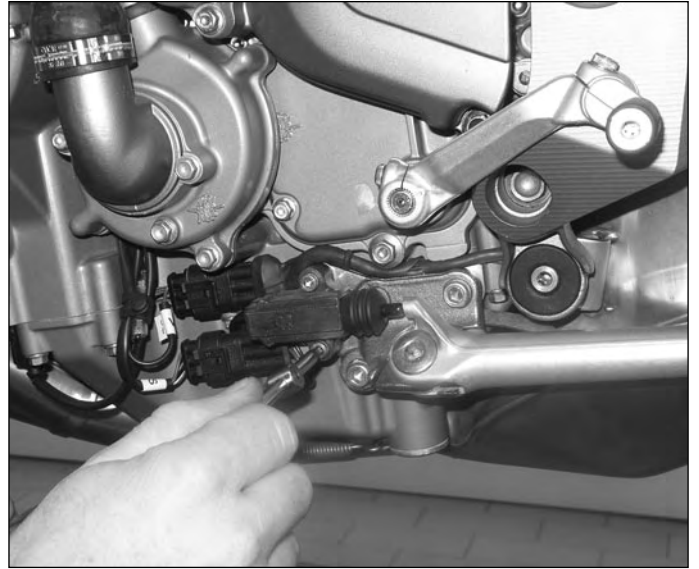

Disconnect the connector of the side stand switch from the main wiring.

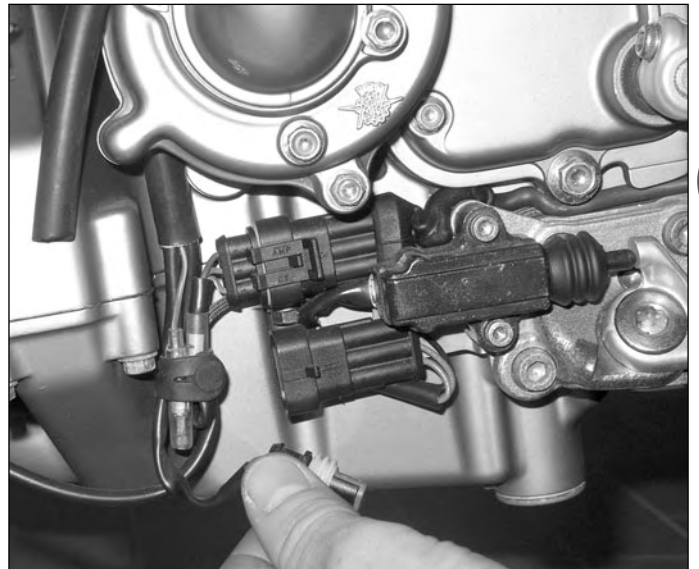

Disconnect the connector of the speed sensor (1) from the main wiring.

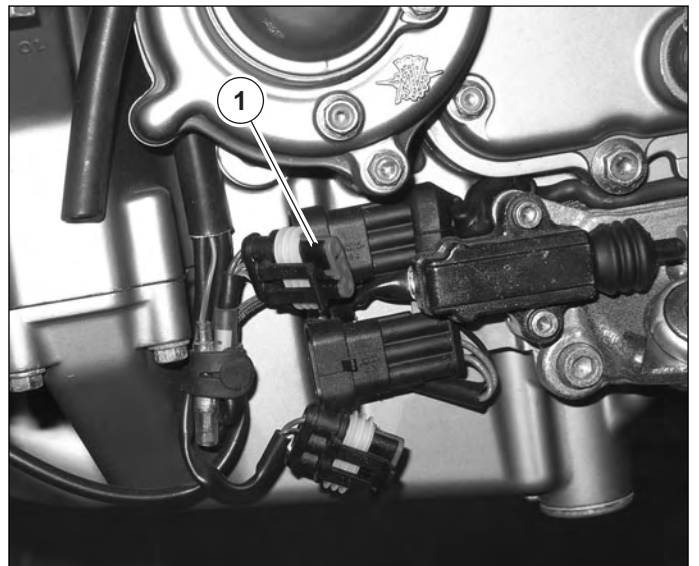

G



Frame

Remove the side stand assembly by unscrewing the three fixing screws (1).

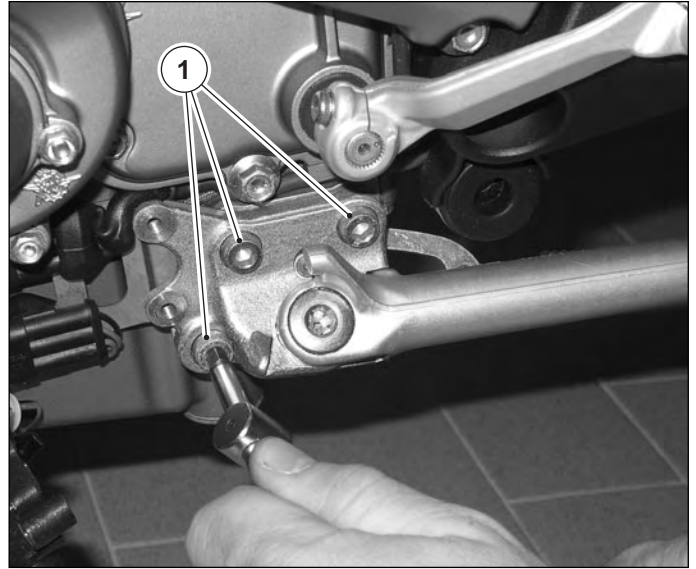

Slide the terminals of the connections out of fixing support.

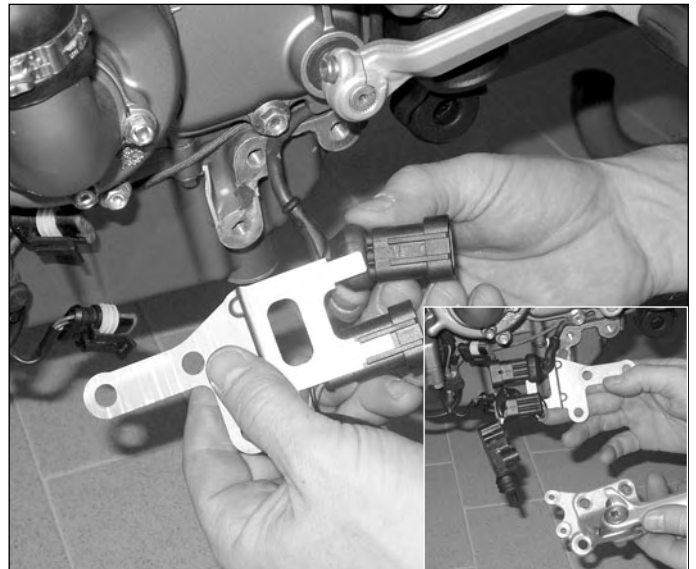

Gearchange lever removal

Unscrew the fixing screw (1) and slide out the gear-change lever (2).

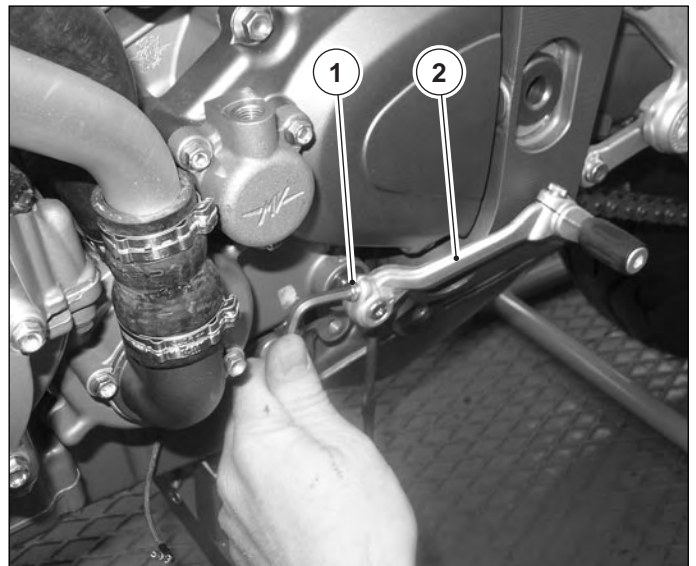



Frame

Operating on the right side of the motorcycle, remove the fixing support of the rear brake fluid tank by unscrewing the fixing screw (1).

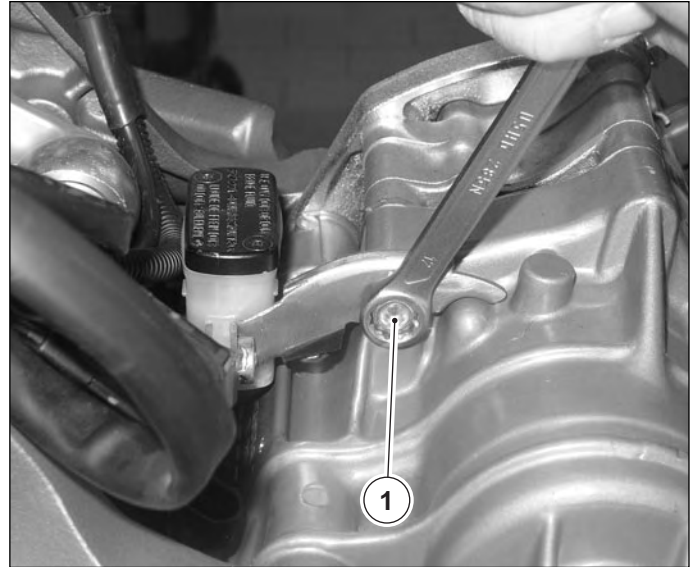

Remove the rear brake pump and the relative protection as described in chapter H "Brakes".

N.B. The figures show the collectors when removed, but the operation is still possible with the exhaust collectors assembled.

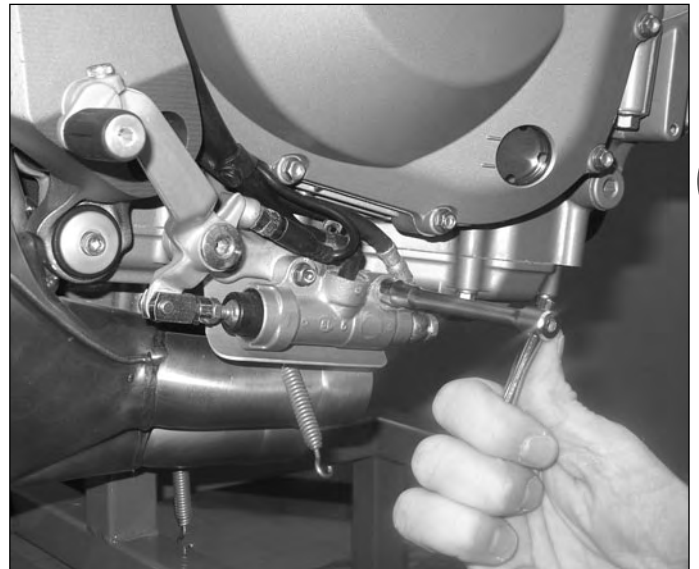

Disconnect the connector of the rear brake stop light from the main wiring.





Frame

Remove the exhaust collectors fixing flanges of the cylinders 1-2-3-4 by unscrewing the fixing nuts.



Unhook the union spring between the compensator and the collector of cylinders 3-4.

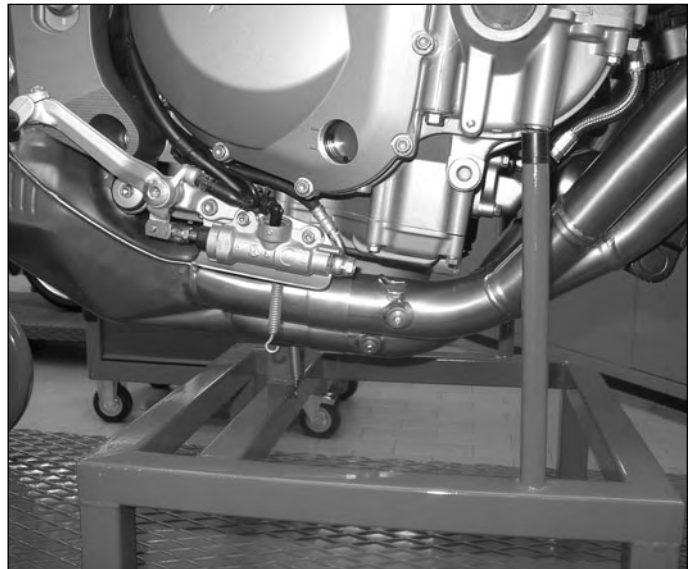

Remove the collector of cylinders 3-4 by sliding it out of the primary compensator.

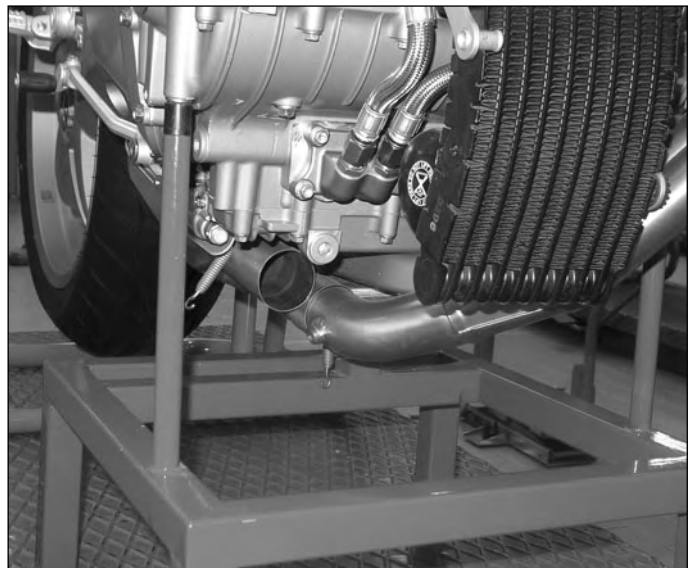



Frame

Unhook the union spring between the compensator and the collector of cylinders 1-2 and remove the collector by sliding it out of the primary compensator.

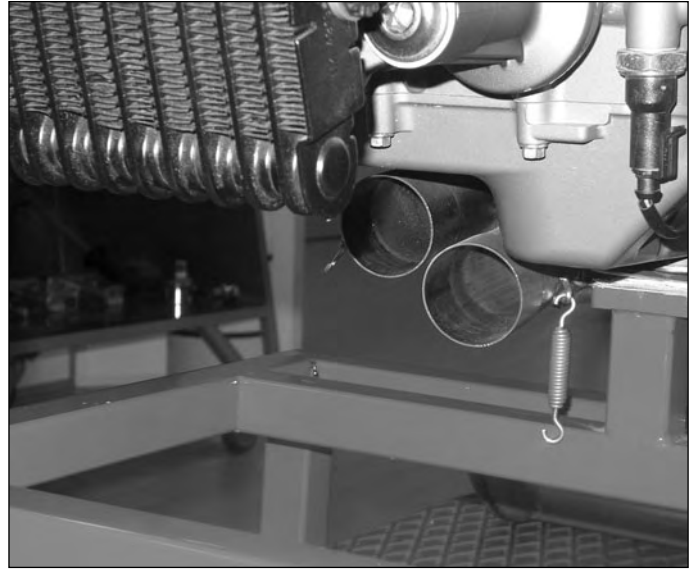

Unhook the two connecting springs between the exhaust group and the silencers.



Remove the connecting plate between the two silencers.



G



Frame

Unscrew the screw fixing the silencers to the support.



Remove the upper silencer first, then the lower one.

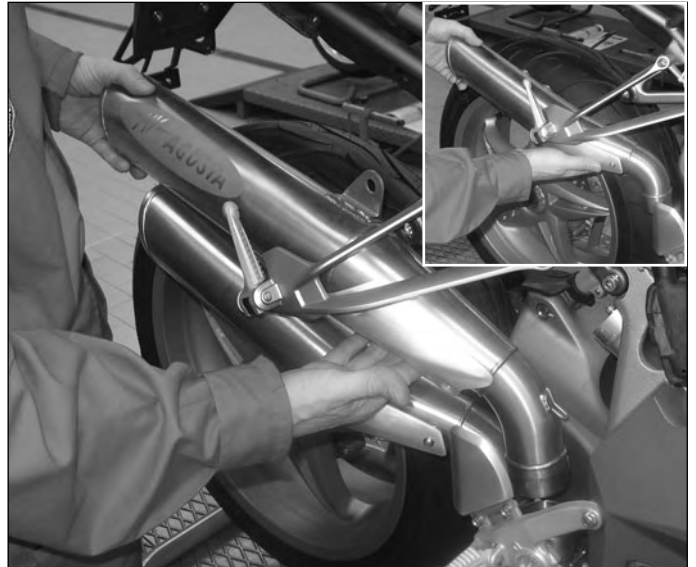

Unscrew the screw fixing the compensator to the frame.

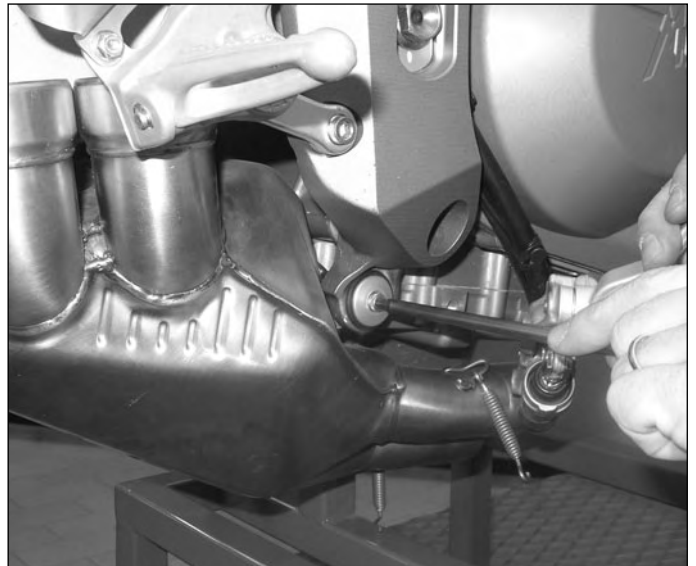



Frame

Remove the exhaust compensator by removing it from the pin on the left side of the frame.



Remove the chain as described in chapter F "Suspensions and wheels".



Position an appropriate lift to support the rear suspension/fork assembly as shown in the figure.

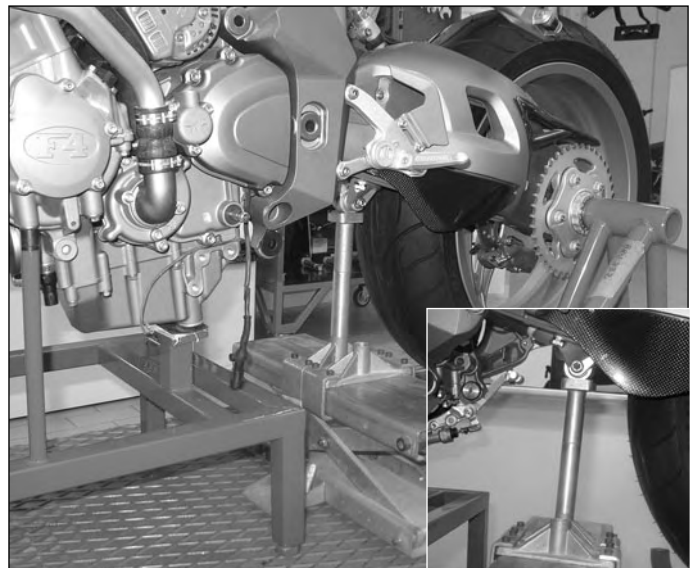



Frame

Slacken the fixing screw of the front fork pin by 1 turn.



Slacken the nut on the rear suspension compensator pin.



Remove the engine support lower pin fixing nut.

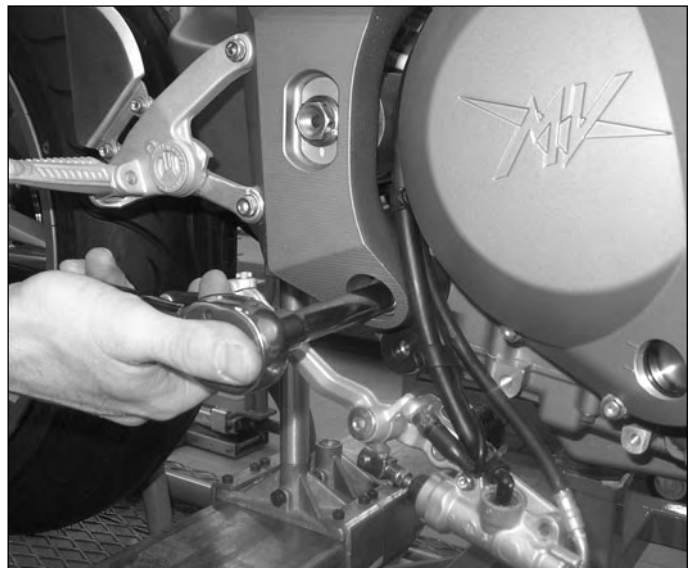



Frame

Operating on the left side extract the engine support pin.

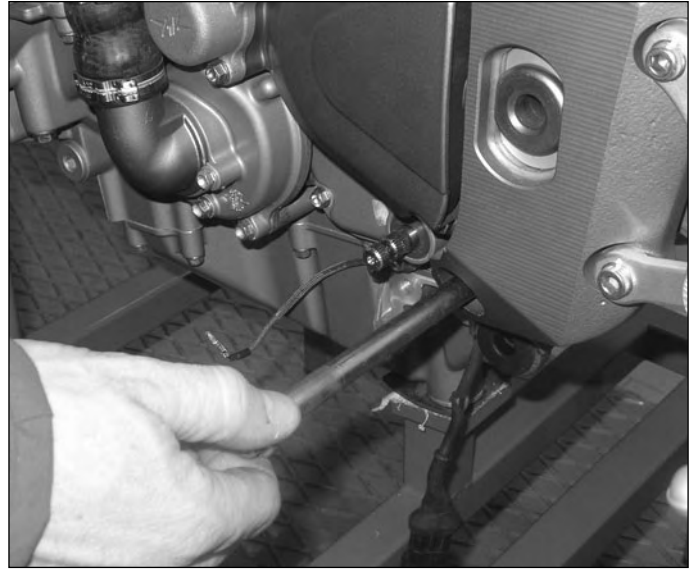

Extract the bush shown in the figure from the union plates of the frame from both sides.



Remove the engine assembly from the union plates by dragging it forwards.

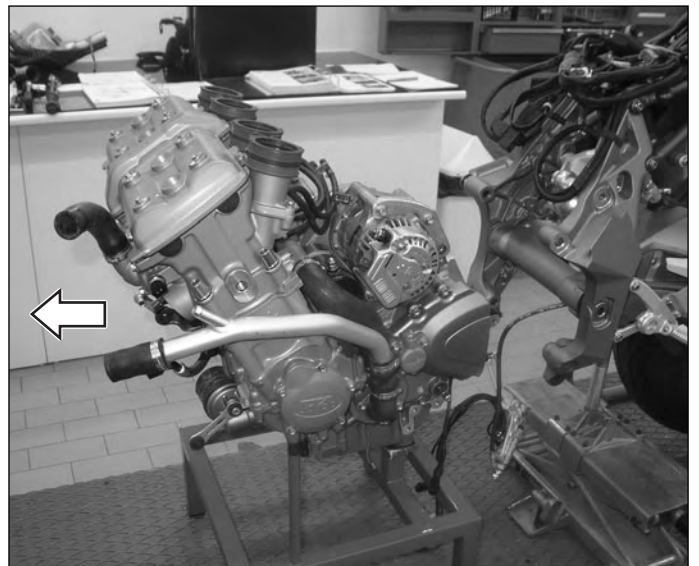

G



Frame

Operating on the right side, remove the fork pin fixing screw (1) taking care to recuperate the washer (2).

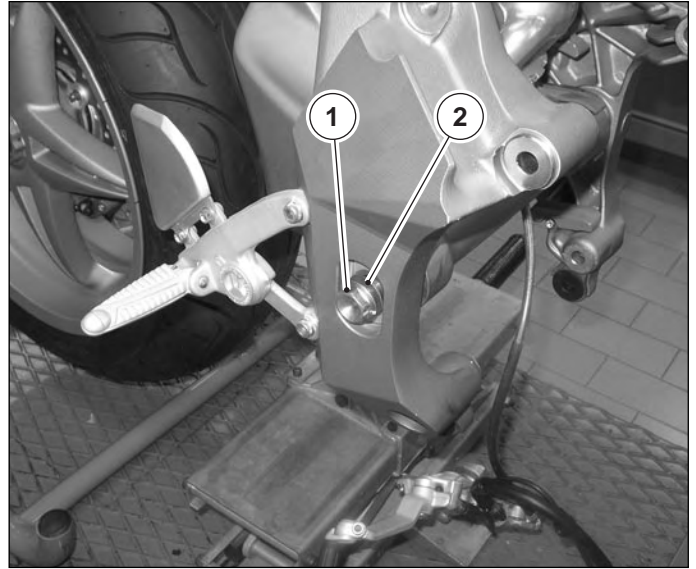

Recuperate the spacer.

N.B. The spacer is present on the Brutale ORO model only.

G Remove the right union plate.



Remove the rear suspension pin fixing nut and slide out the pin from the left side.





Frame

Remove the fork pin (1) and the spacer (2).

N.B. The spacer is present on the Brutale ORO model only.

Remove the left union plate.

When reassembling proceed in the reverse order of removal, taking care to apply the prescribed grease and to tighten every fixing to the torque pressure indicated on page 20 of this chapter.

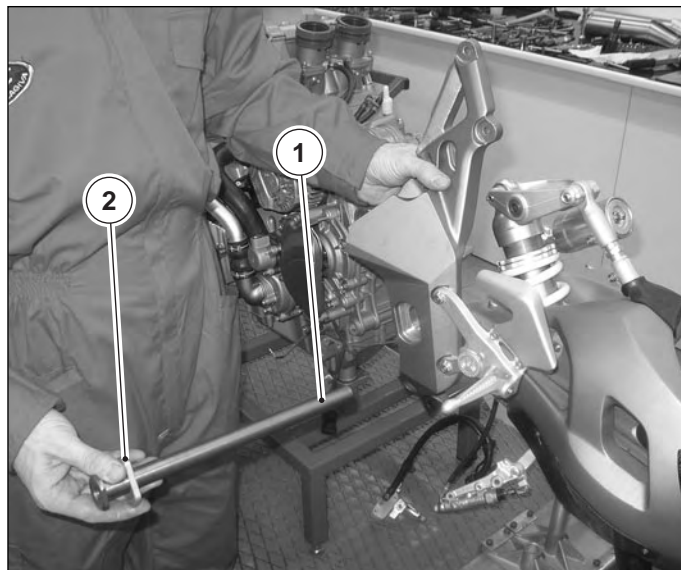

If it is necessary to remove the rider footrests, remove them by unscrewing the two fixing (1) screws.

N.B. When reassembling tighten the footrest fixing screws to the prescribed torque pressure.



Torque pressure of the screws fixing the footrests to the label: 24 ÷ 28 N • m.

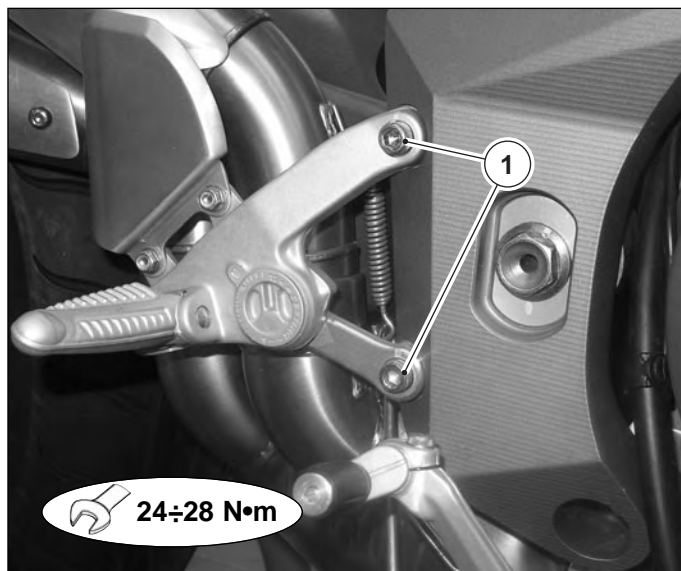

G



Frame

G



Brakes

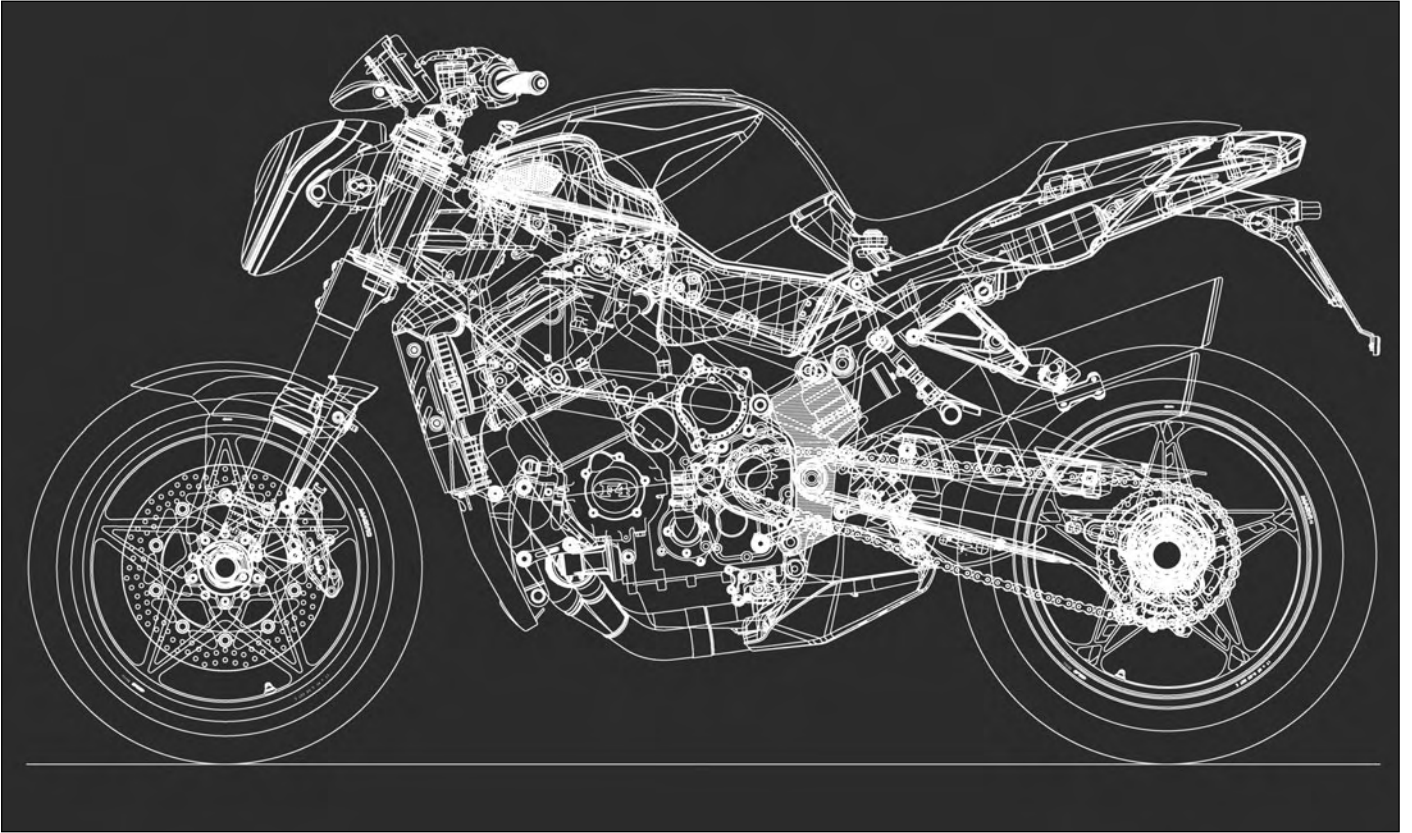

H

SECTION H

Revision 0



Brakes

SUMMARY

FRONT BRAKE SYSTEM.....	PAGE 3
FRONT MUDGUARD REMOVAL	PAGE 4
FRONT BRAKE PADS SUBSTITUTION	PAGE 4
SUBSTITUTION AND BLEEDING OF THE FRONT BRAKE FLUID	PAGE 6
FRONT BRAKE CALIPERS SUBSTITUTION.....	PAGE 10
FRONT BRAKE PUMP REMOVAL	PAGE 11
FRONT BRAKE LEVER REMOVAL.....	PAGE 12
CLUTCH LEVER REMOVAL	PAGE 13
FRONT BRAKE DISCS	PAGE 14
FRONT BRAKE DISC REMOVAL REMOVAL	PAGE 15
REAR BRAKE SYSTEM.....	PAGE 18
REAR BRAKE PADS SUBSTITUTION	PAGE 19
SUBSTITUTION AND BLEEDING OF THE REAR BRAKE FLUID.....	PAGE 22
REAR BRAKE CALIPER SUBSTITUTION	PAGE 24
REAR BRAKE DISC	PAGE 26
REAR BRAKE DISC REMOVAL	PAGE 27

H



Brakes

FRONT BRAKE SYSTEM

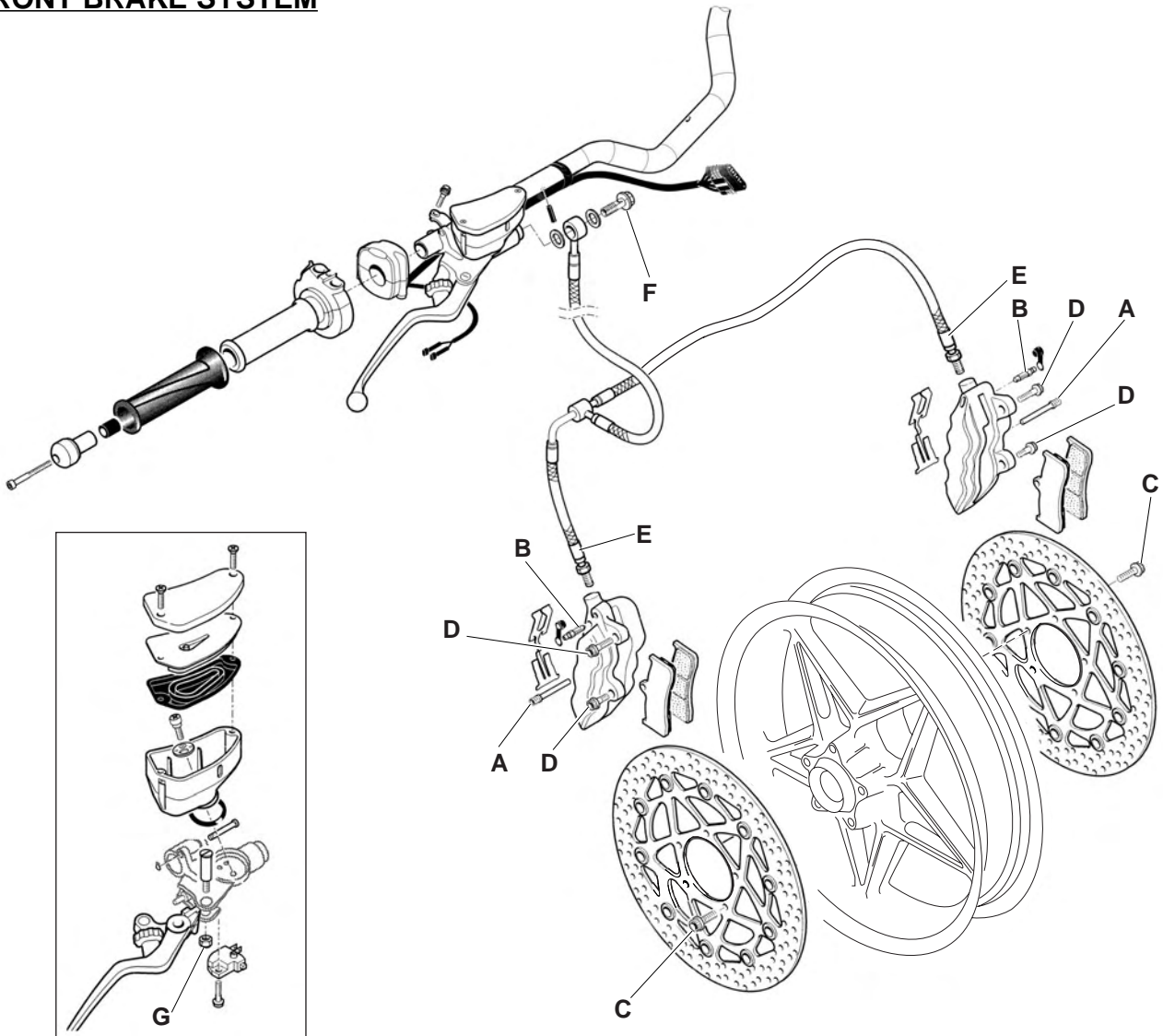

		A	B	C	D	E	F	G		
Torque pressure	N•m	15 ÷ 20	8	23 ÷ 25	38 ÷ 42	16 ÷ 18	16 ÷ 18	8 ÷ 10		
	Kg•m ft•lb									
Operation				Loctite 243*						

Description	BRUTALE ORO	BRUTALE S
FRONT BRAKE		
Type	Semi-floating double disc with the braking area in steel	
Ø disc (mm)	310	310
Disc flanges	Aluminium	Steel
Pincers (Ø pistons mm)	6 pistons Ø 22.65; Ø 25.4; Ø 30.23	
Front disc thickness (mm)	4.8	4.8
Min. pad thickness (mm)	1	1

* : For the F4 ORO Series do not apply thread-locking fluid



Brakes

FRONT MUDGUARD REMOVAL

Remove the four screws of the rear attachment of the front mudguard as shown in the figure (the two lower screws are mounted with a bush).

Remove the front brake tubing from the clip mounted on the attachment.

Widen the attachment and slide it out of its seat.

Remove the two right and left screws with their bushes from the mudguard.

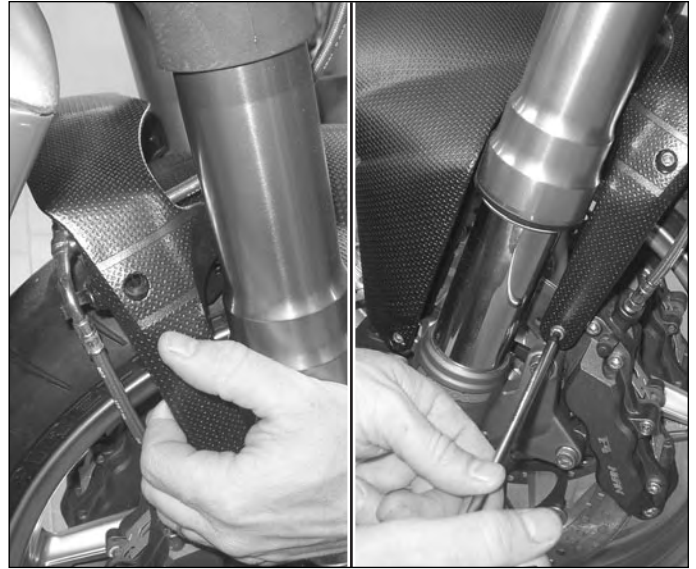

FRONT BRAKE PADS SUBSTITUTION

Widen the pads with a pincer so that the pistons are pushed back into their seats (as shown in the figure).



The movement towards the outside of the brake pads makes the pistons go back into their seats, with the consequent increase in the level of the brake fluid in the brake fluid chamber.

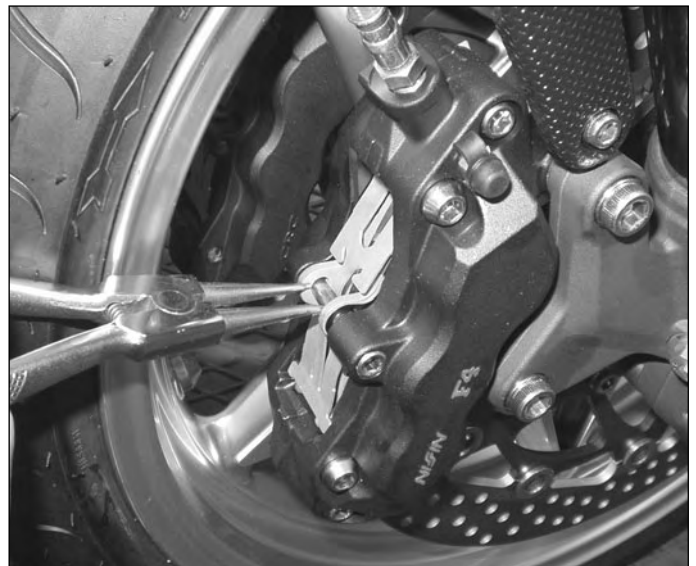



Brakes

Unscrew the pad support pin as indicated in the figure.

Compress the spring and extract the pin.

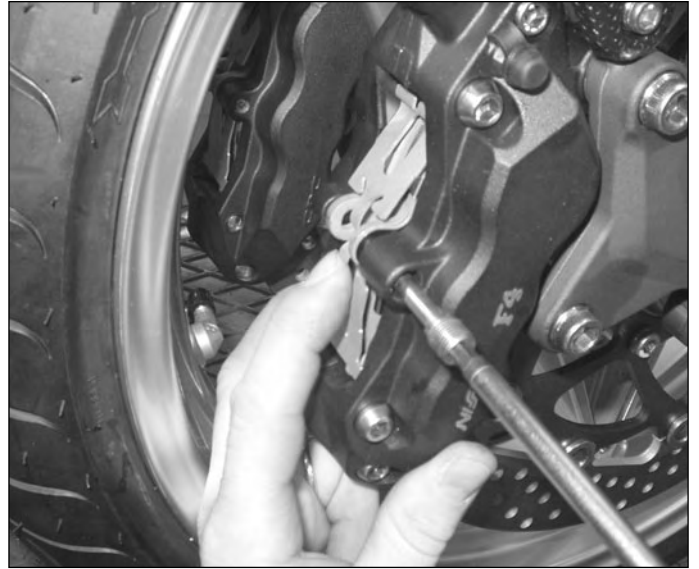

Remove the pads.



Every 6000 kilometres, check the wear of the pads. The pad thickness must not be less than **1 mm**. If the pads are excessively worn, substitute them.

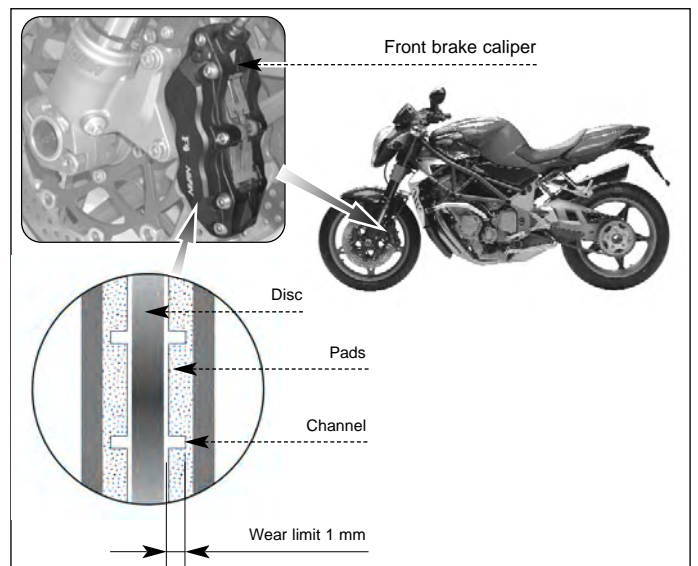



Brakes

To effectuate the assembly of the new pads, align the holes of the pads with the holes in the caliper. After having visually checked the condition of the pad plates, check that they offer sufficient pressure to the pad during the assembly phase.

Check the condition of the pad-retaining threaded pin. It must be perfect.

Check that there are not signs of brake fluid on the brake/tube union and on the bleeder valve.

Check the pad plate direction proceeding as shown in the figure.

 **Ensure the correct assembly of the pad plates.**



Tighten the pin to the prescribed torque pressure.

 **Front brake pad pin torque pressure: $15 \div 20$ N•m**

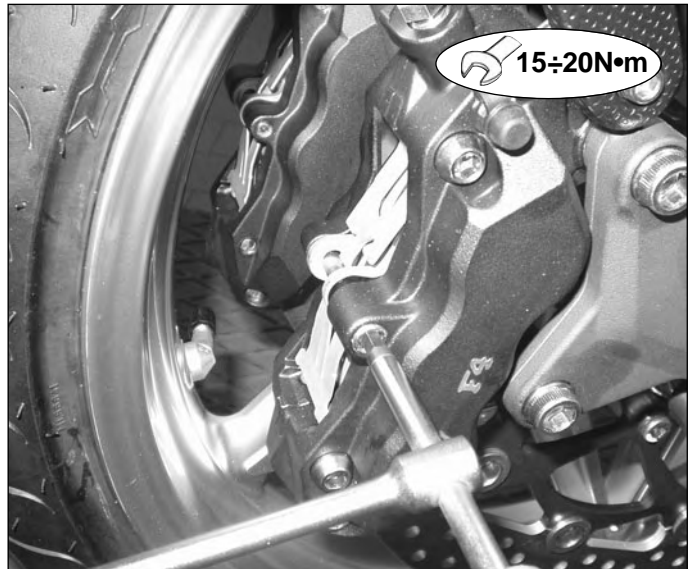

SUBSTITUTION AND BLEEDING OF THE FRONT BRAKE FLUID

Place the motorcycle on a horizontal surface with the steering in a straight line.

Protect the area with a cloth.

Remove the two front brake fluid chamber cover.

 **Brake fluid has a strong corrosive power. Be careful to not spill the fluid on surrounding parts.**

If the fluid is spilt clean immediately with industrial alcohol and dry with compressed air.





Brakes

Repeatedly squeeze the front brake lever, then hold it continuing the braking action.

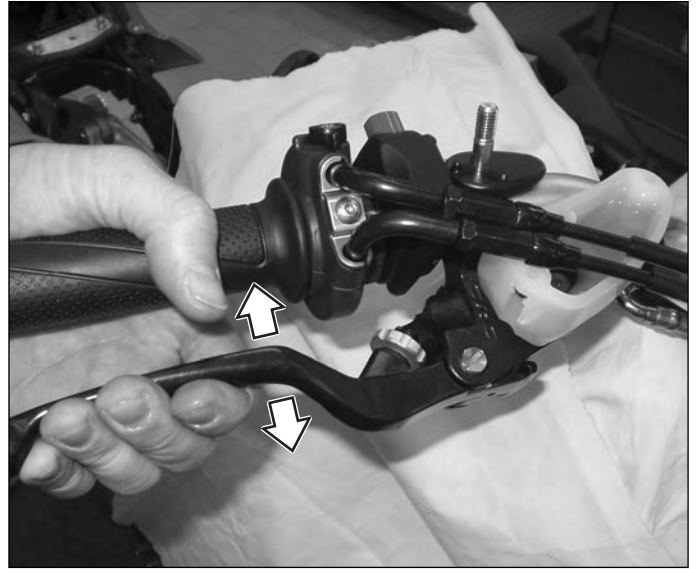

Remove the protection cap of the bleed valve of the front right caliper.

Apply a rubber tube to the bleed valve (the valve is placed on the summit of the brake pincer).

Put the other end of the rubber tube in a suitable container.

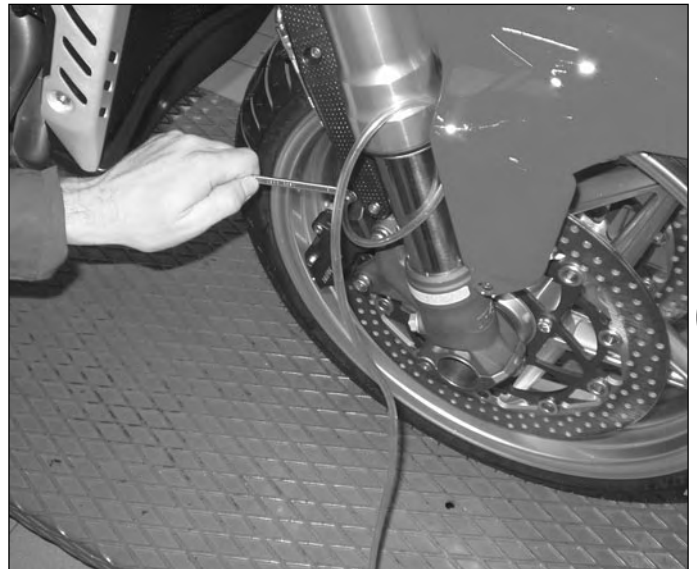

Slacken the bleed valve and empty the brake system. Squeeze the brake lever and proceed until reaching the minimum level in the chamber; top-up with new brake fluid and continue the operation until brake fluid of a different colour comes out.

N.B. Repeat this operation on both pincers.

Tighten the bleed valve, remove the rubber tube and insert the protection cap.

The quantity of brake fluid necessary for this operation is approximately **250 cc**.



H



Brakes

Continue the operation for both calipers, proceeding as described previously.
Pour new brake fluid into the chamber until it reaches the maximum level.



Recommended brake fluid : AGIP Brake Fluid DOT 4



Utilise only the prescribed brake fluid from sealed containers. NEVER use old or used brake fluid.



If the bleeding has been done correctly, the movement of the lever is short and without any elastic effect.

Repeat the bleeding operation if there is still sponginess at the lever.



After having disconnected the rubber tube for the collection of the fluid, dry the bleed valve union.



H



Brakes

Top-up the level of the fluid until it reaches the maximum mark.



Carefully clean around the edge of the brake fluid chamber utilising a clean cloth.



Imperfect cleaning of this component could cause the loss of small quantities of brake fluid whilst riding.



Accurately clean the three elements of the brake fluid chamber cap with alcohol and dry with compressed air.





Brakes

Place the cap on the brake fluid chamber and tighten the two lateral fixing screws.



FRONT BRAKE CALIPERS SUBSTITUTION

Pull the front brake lever as near as possible to the right handgrip maintaining it in position with an elastic band before starting the removal operation of the brake caliper.

To bring the brake lever in contact with the handgrip, it is necessary to remove the brake pads or to slacken the union as indicated in the figure, taking care to not spill the brake fluid that is inside the system.

 **Brake liquid can corrode painted surfaces. Clean immediately any spilt brake liquid using industrial alcohol and drying with compressed air.**



Remove the caliper union.
Remove the two caliper fixing screws (1) indicated in the figure. Remove the brake caliper.

N.B. The removal operation for both the right and left front calipers is identical.

To reassemble the front brake calipers proceed in the reverse order to removal.
Tighten the relative fixing screws to the prescribed torque.

 **Torque pressure of the fixing screws of the front brake calipers: 38÷42 N•m**

 **Torque pressure caliper union: 16÷18 N•m**

If the pads have been removed, reassemble them and check the minimum pad thickness.
Proceed with the bleeding of the system as described in page 6.

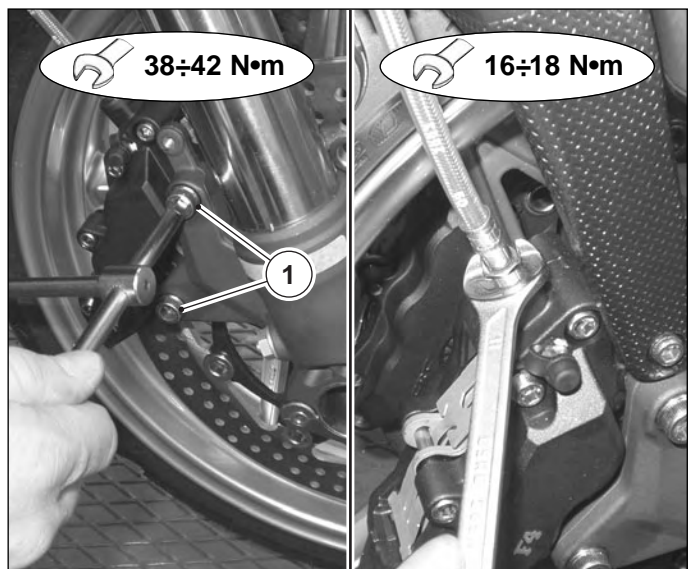

FRONT BRAKE PUMP REMOVAL

Empty the system of brake fluid as described in page 6.

Remove the union indicated in the figure.



Brake fluid is extremely corrosive. Avoid contact with the eyes, skin and nose. Wash abundantly with water and call a doctor if accidental contact occurs.



During the following operations, avoid contact with painted surfaces.



Remove the connectors of the electrical system.



Remove the fixing screw that fixes the pump to the handlebar.

Open the clamp.

Push down to remove the pump from the reference pin.





Brakes

To substitute the front brake switch remove the screw shown in the figure.

 **After having carried out the overhaul of the front brake pump assembly, carefully wash and bleed the front brake system as previously described in this chapter.**

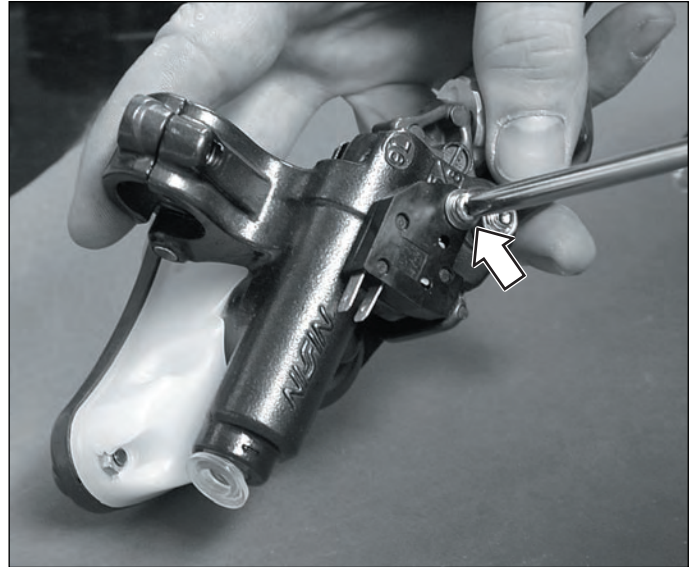

FRONT BRAKE LEVER REMOVAL

Unscrew the fixing nut locking the pin rotation with a screwdriver.



Unscrew the pin and remove it; then remove the brake lever.





Brakes

 **When reassembling take care to insert the lever into its seat.**

Grease the pin:



Recommended grease: Agip Grease 30

Insert the pin into the seat and screw it in until the beat is reached, then tighten the nut by using a screwdriver.



Front brake lever nut torque pressure: $8 \div 10 \text{ N} \cdot \text{m}$

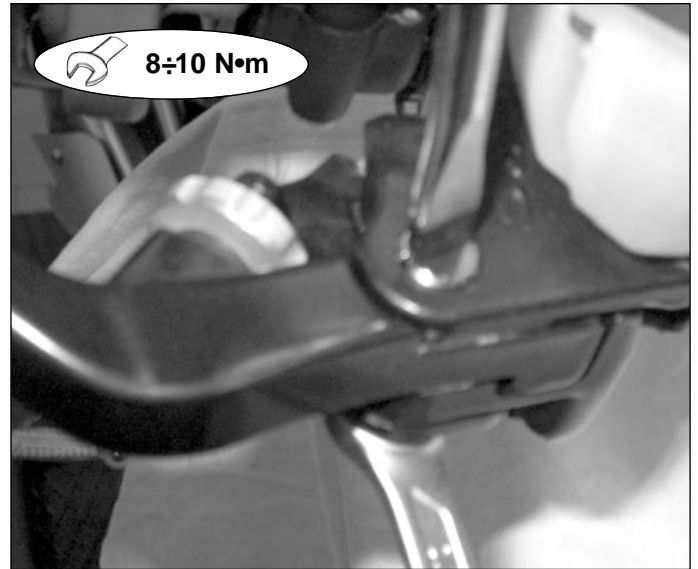

CLUTCH LEVER REMOVAL

Remove the nut shown in the figure.

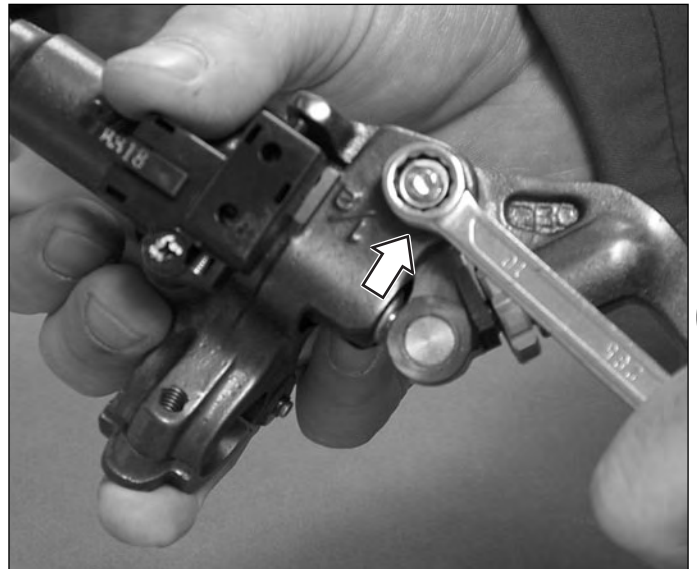

Unscrew the pin and extract it.
Remove the clutch lever.

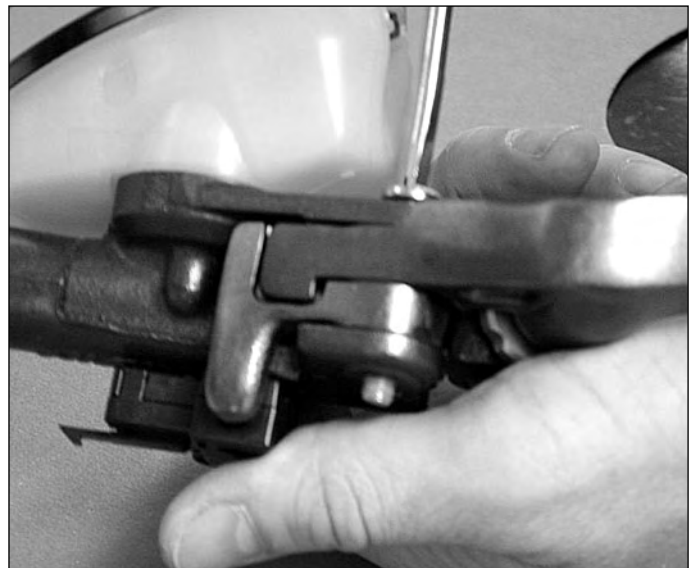

H



Brakes



When reassembling, be careful to insert the pin of the pump piston into the seat situated on the lever (see figure).

Grease the pin:



Recommended grease: Agip Grease 30

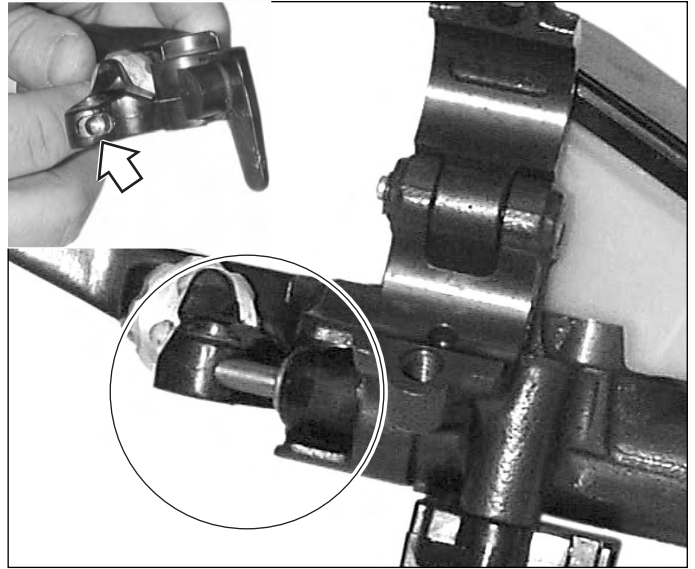

For the reassembly of the lever tighten the pin. Keeping the pin still, tighten the nut with a screwdriver.



Clutch lever nut torque pressure:
 $8 \div 10 \text{ N} \cdot \text{m}$

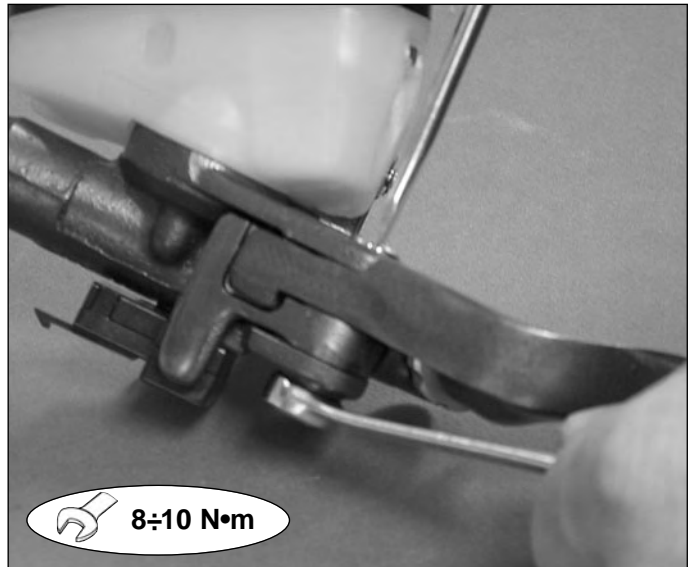

FRONT BRAKE DISCS

Check the thickness of the front discs utilising a micrometer gauge. Carry out the measurement at least at three points with 120° between them, as shown in the figure.



Utilise a micrometer gauge for this check.

The minimum thickness of the discs vary with the type of disc used:

- For brake discs with a thickness of **4,8 mm** the minimum thickness is **4,5 mm**.

This operation just be carried out on both front discs.



If the measurements are below the minimum, substitute the component with a new one.





Brakes

FRONT BRAKE DISC REMOVAL REMOVAL

Remove the front wheel from the motorcycle (see paragraph "Front brake caliper removal").
Remove the front wheel pin utilising two special tools (see chapter F "Suspensions and wheels").



Special tool 800092872



Place the wheel in a horizontal position on a work plane and remove the five screws of each disc proceeding in a star-like mode for the removal.
Visually check the discs for lines or score marks.



Place the milled side of the brake disc flange on a level surface with the milled side face down and utilising a micrometer gauge check that the maximum oscillation of the disc reached during a rotation of 360° does not exceed **0,3 mm**.



Utilise a micrometer gauge for this check.



If the oscillation is higher than 0.3 mm, substitute the disc with a new one.

This operation must be carried out on both front discs.

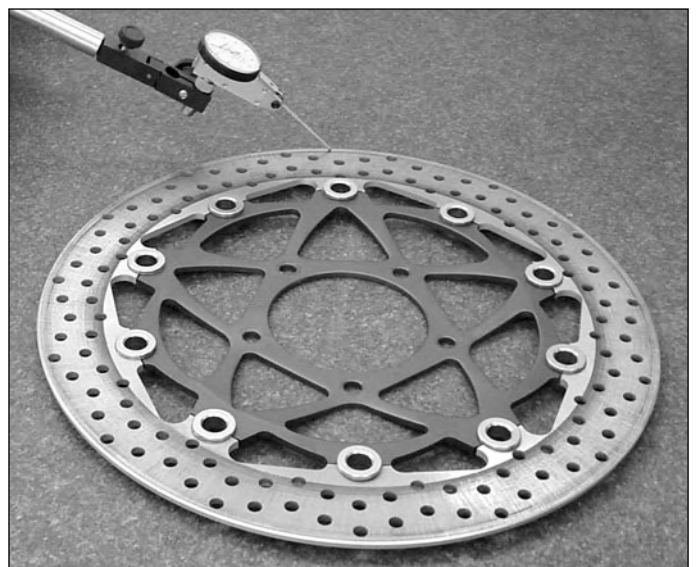

H



Brakes

Front disc assembly

Thoroughly clean the contact surfaces of the discs and the wheel.

Accurately grease all relative surfaces of the disc before reassembling.

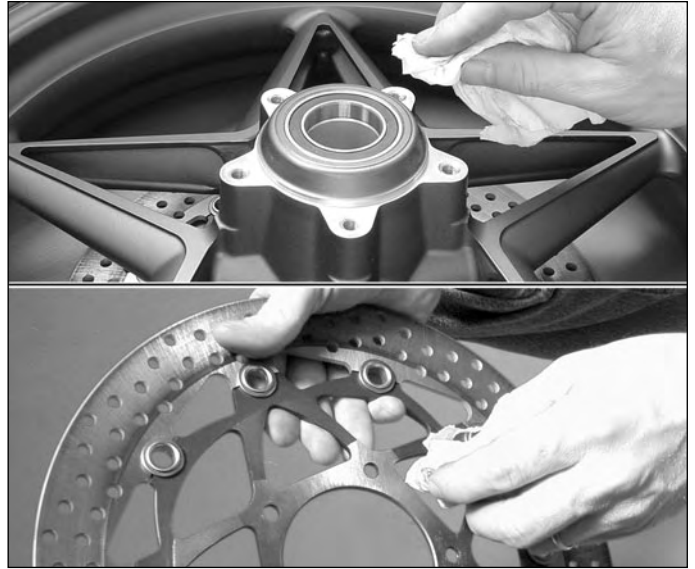

The following operation must be carried out only on the following model:

- **Brutale S**

Apply thread-locking fluid to the five fixing screws of the disc.



**Recommended thread-locking fluid:
Loctite 243**



The following operation must be carried out only on the following model:

- **Brutale ORO**

Apply dielectric grease to the five fixing screws of the disc.



Recommended grease : Valvoline Tectyl 511





Brakes

Screw in the screws lightly, proceeding in a star-like mode.
Continuing in a star-like mode, tighten the screws to the prescribed torque pressures.



Front brake disc screw torque pressure:
23 ÷ 25 N•m

Be careful to reassemble the discs in the original positions (it is advisable to mark them by applying an adhesive label).



This operation is important so that a good contact between the brake discs and the relative pads.

Reassemble the wheel pin and the wheel as described in chapter F "Suspensions and wheels".



REAR BRAKE SYSTEM

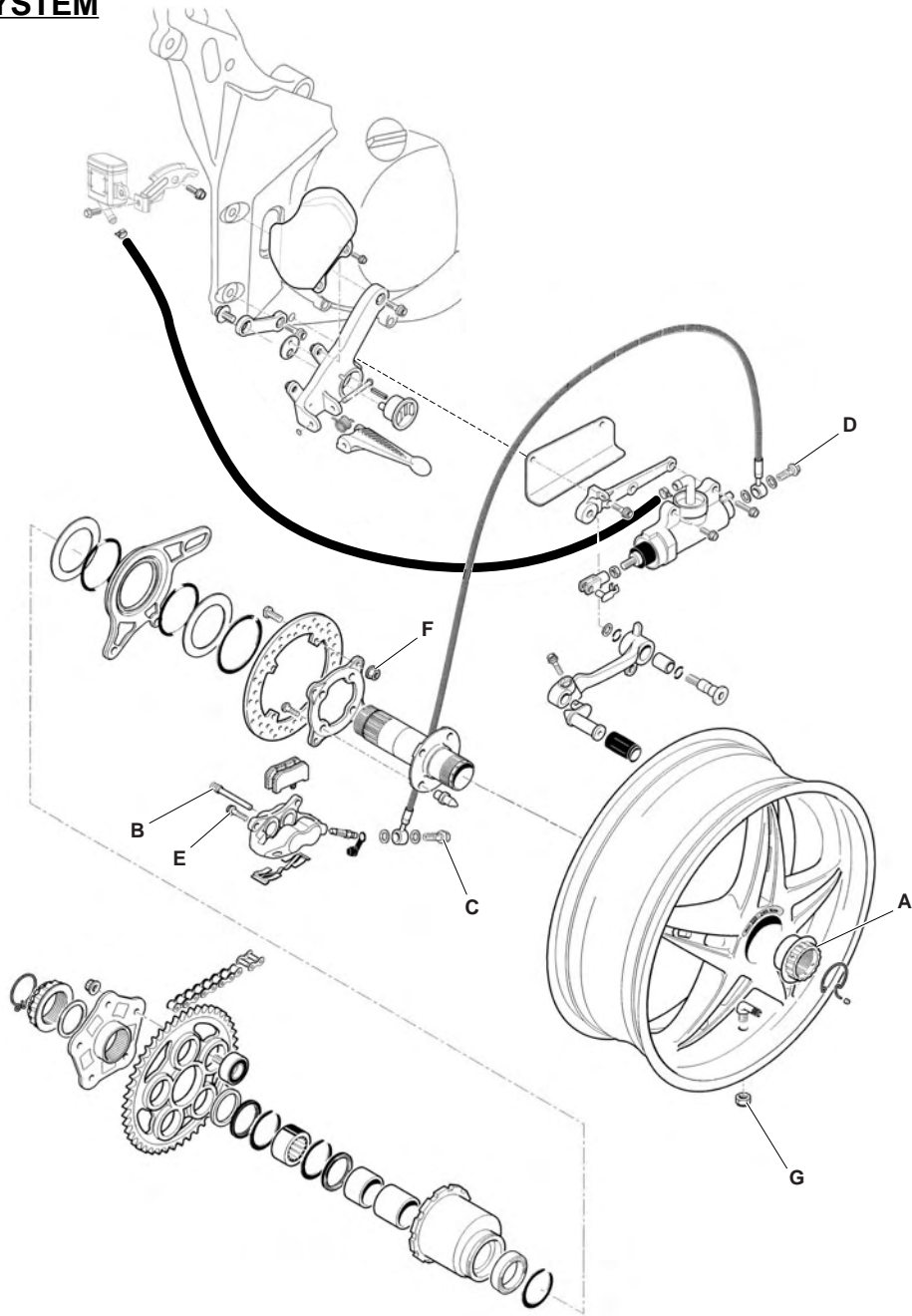

H

		A	B	C	D	E	F	G			
Torque pressure	N•m	220 ÷ 240	15 ÷ 20	16 ÷ 18	16 ÷ 18	18	18 ÷ 20	5 ÷ 7			
	Kg•m										
	ft•lb										
Operation						243	270				

Description	BRUTALE ORO	BRUTALE S
REAR BRAKE		
Type	Steel disc	
Ø disc (mm)	210	210
Pincer (Ø piston mm)	4 pistons Ø 25.4	
Disc thickness (mm)	6	6
Minimum pad thickness (mm)	1	1



REAR BRAKE PADS SUBSTITUTION

Place the motorcycle on the rear stand.



Special tool N. 800092642

Remove the fixing screws of the lower silencer.



Remove the exhaust protection.



Turn the lower silencer outwards slightly.
If this movement is difficult due to residues in the area of connection to the compensator, clean the part applying lubricant / **WD-40** unblocking spray.
Rotate the silencer in a clockwise or anti-clockwise direction alternatively to allow the lubricant to seep through.



H



Brakes

Remove the retaining ring of the wheel nut.
Remove the rear wheel by removing the polygonal nut, using the following tools:

-  **Torque wrench**
-  **55 mm polygonal spanner**

Utilising a torque wrench, slacken the rear wheel nut.



The polygonal fixing nut of the rear wheel has a left hand thread. To slacken the nut it is therefore necessary to turn the torque wrench in a clockwise direction.



Remove the rear wheel nut.

N.B. When reassembling, tighten the rear wheel nut to the prescribed torque pressure.



Rear wheel nut torque pressure: 220 ÷ 240 N•m

 **220÷240 N•m**



Remove the rear wheel taking care to not hit the silencer connecting plate.

N.B. If this operation is too difficult to carry out, remove the silencer connecting plate completely before removing the wheel.





Brakes

Utilising circlip pincers as shown in the figure, widen the pads so that the pistons are pushed back into their seats.



The outward movement of the brake pads provokes the retraction of the pistons in their relative seats, with a consequent increase in the level of the brake fluid in the brake fluid chamber.



Remove the pad support pin and the relative spring.

Remove the pad by letting it drop down.



Rear brake pads

Wear/substitution check:

the first time after 1000 kilometres; then every 6000 kilometres.

Check the wear condition and the thickness of the brake pads on the calipers.

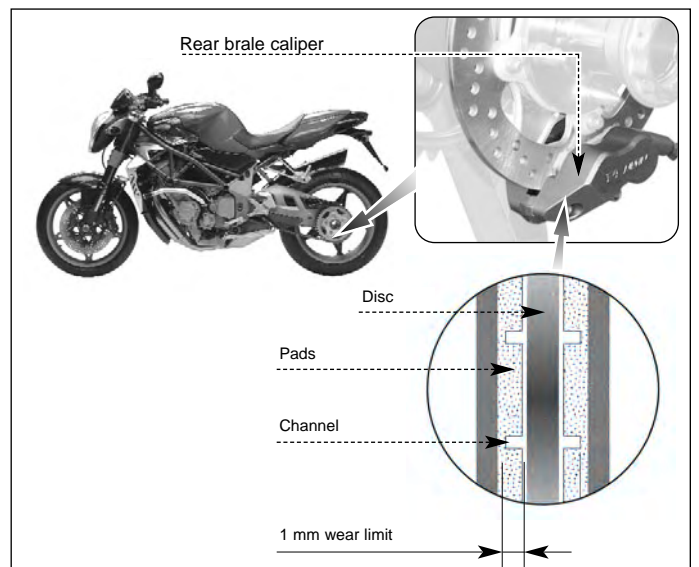

H



Brakes

Analyse the condition of the rear brake system and its components.
Proceed with the reassembly in the reverse order of removal.



Tighten the pin to the prescribed torque pressure.

Rear brake caliper pin torque pressure: 15 ÷ 20 N•m

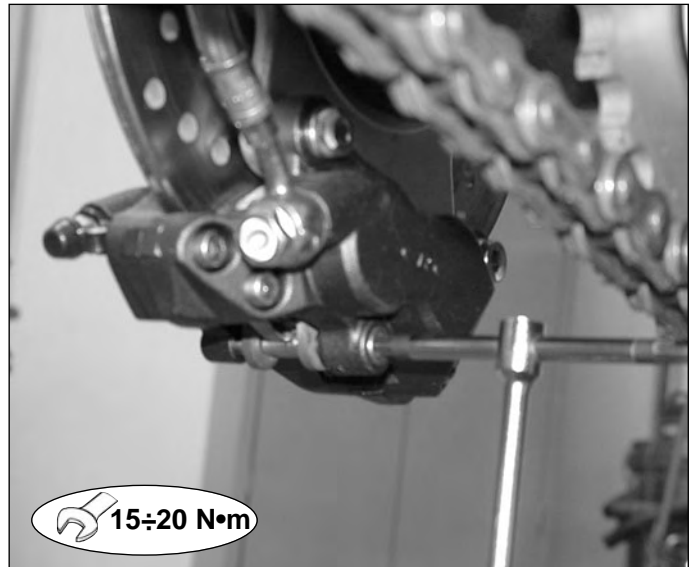

SUBSTITUTION AND BLEEDING OF THE REAR BRAKE FLUID



The operation described herewith must be carried out with the engine cold: the position of the brake fluid tank could cause grave burns.

To carry out this operation it is necessary to remove the passenger seat, the rider seat and the fuel tank, to accede to the brake fluid tank as described in chapter C "Bodywork".





Brakes

Open the cover of the rear brake fluid reservoir by removing the two screws.



Be careful to not spill the fluid from the reservoir during these operations. Brake fluid is extremely corrosive. Avoid contact with the eyes, skin and nose. Wash abundantly with water if contact is accidentally made and consult a doctor. During the successive operations, avoid spilling the fluid onto painted surfaces.



Connect a rubber tube to the bleed valve, empty the system in an appropriate container by slackening the bleed valve as shown in the figure.



H



Brakes

Tighten the bleed valve.

Fill the rear brake fluid reservoir until the fluid reaches the maximum level.



Recommended brake fluid : AGIP Brake Fluid DOT 4



Utilise exclusively the prescribed brake fluid. Use only new brake fluid from sealed containers. NEVER utilise old or used brake fluid.

Before closing the fluid reservoir, check the condition of the components.

Carry out bleeding also on the front brakes (see the paragraph in this chapter).



REAR BRAKE CALIPER SUBSTITUTION

To facilitate the operation, remove the brake pads as described previously.

Empty the system of brake fluid as described in paragraph "Substitution and bleeding of the rear brake fluid".

Remove the tubing by unscrewing the union indicated in the figure.



H Be careful of the residue fluid that remains inside the pincer unit.

Remove the two screws indicated in the figure.

Substitute the caliper.

For reassembly, tighten the two screws to the prescribed torque pressure.



18 N•m



Rear brake caliper screw torque pressure: 18 N•m



Apply Loctite 243

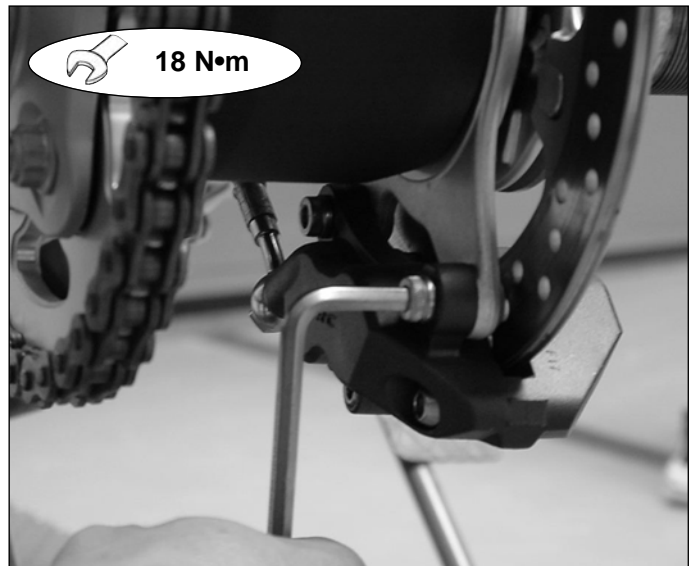



Brakes

Assemble the union tightening to the prescribed torque.



Torque pressure: $16 \div 18 \text{ N}\cdot\text{m}$

N.B. Substitute the gaskets with new ones.

If the brake pads have been removed, reassemble them.

Proceed with the filling and bleeding of the rear brake system (see page 22).



Rear brake pump removal

Carry out the emptying of the brake system as previously described in paragraph "Substitution and bleeding of the rear brake fluid".

Remove the clips complete with the fixing pin of the rear brake lever and the pump control fork by rotating and successively pushing inward as shown in the figure.



Unscrew the union indicated by the arrow in the figure, thereby freeing the pump the brake tubing.

N.B. The figures show the collectors when removed, but the operation is still possible with the exhaust collectors assembled.

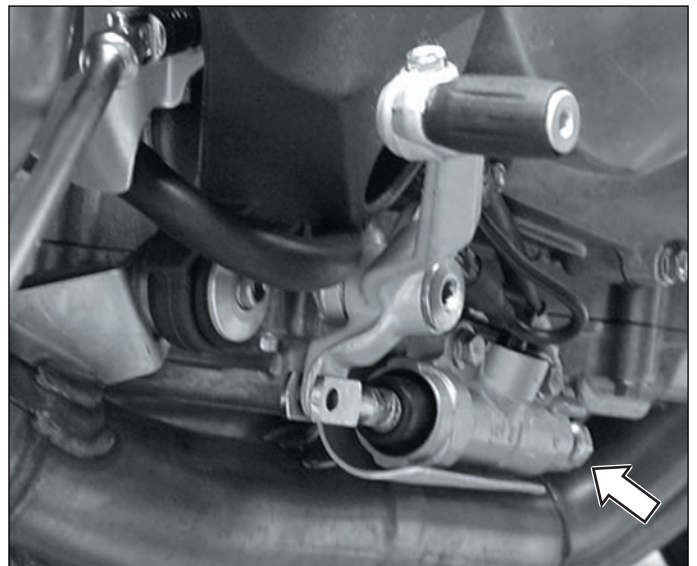

H



Brakes

Unscrew the two fixing screws of the brake pump to its relative support.
Remove the pump.

N.B. The figures show the collectors when removed, but the operation is still possible with the exhaust collectors assembled.



After having carried out a check on all components and substituted those used, damaged or defective proceed with the assembly by following the procedure in reverse order of removal.

N.B. Substitute the gaskets of the pump/caliper hoses.

Tighten the fixings to the prescribed torque pressure.

H  **Torque pressure pump union:**
16÷18 N•m

 **Torque pressure of the screws fixing the brake pump to the support:**

 **Screws M6: 8÷10 N•m - Screws M8: 23÷25 N•m**

Conclude the operations by filling the system with brake fluid and successively bleeding the system (see page 22).

REAR BRAKE DISC

Check the thickness of the rear brake disc.
Substitute the disc if the measurements are less than the minimum value allowed. Effectuate the substitution as hereby described.

- **Minimum thickness allowed: 5.7 mm**

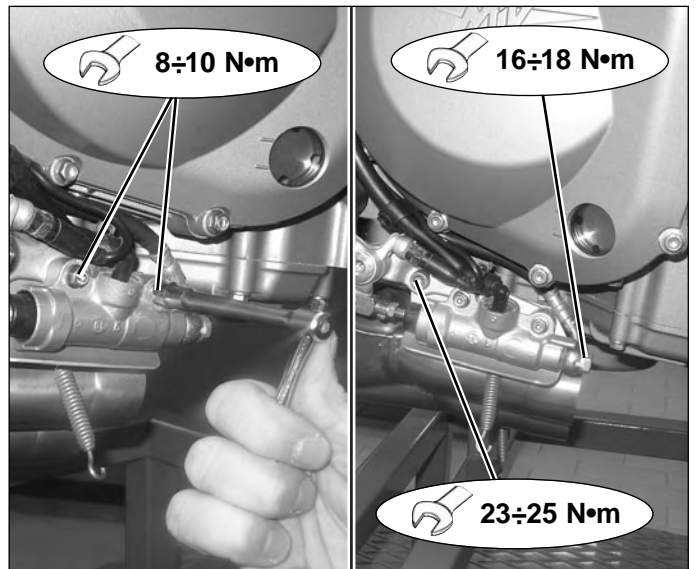

REAR BRAKE DISC REMOVAL

Before proceeding with the removal of the rear brake disc, it is necessary to carry out certain operations described previously in this chapter:

Remove the rear wheel.

Remove the rear brake disc from its support.

Remove the four nuts fixing the disc to the flange splined to the wheel pin.

Remove the four nuts previously freed by extracting them from the rear part of the motorcycle and rotating the disc to facilitate the removal of the nuts.

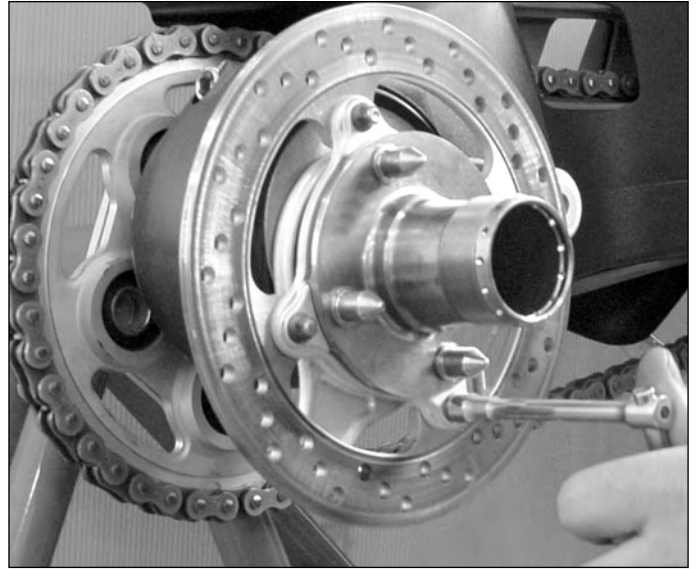

Check the planarity of the rear brake disc by utilising a micrometer gauge and placing the disc on a level work surface. Utilise the same procedure adopted for the front wheel discs.

The planarity value must not exceed **0.3 mm**.



Utilise a micrometer gauge with support to carry out this check.



Check the thickness of the rear brake disc by utilising a micrometer gauge. Carry out the measurement at least at three points with 120 ° between them.

The minimum thickness of the disc must not be less than **5.7 mm**.



Utilise a micrometer gauge for this check.





Brakes

Before reassembling the rear brake disc, check the condition of the four pins and four special nuts. Proceed with tightening of the nuts.



The screws must be assembled with the nuts screwed in lightly and brought into contact with the disc surface. After this operation, tighten the four nuts in a cross-like mode.



Rear brake disc nut torque pressure: 18÷20 N•m.



Apply Loctite 270

Conclude the reassembly operations of the various components by following the procedures previously described in these paragraphs in reverse order.

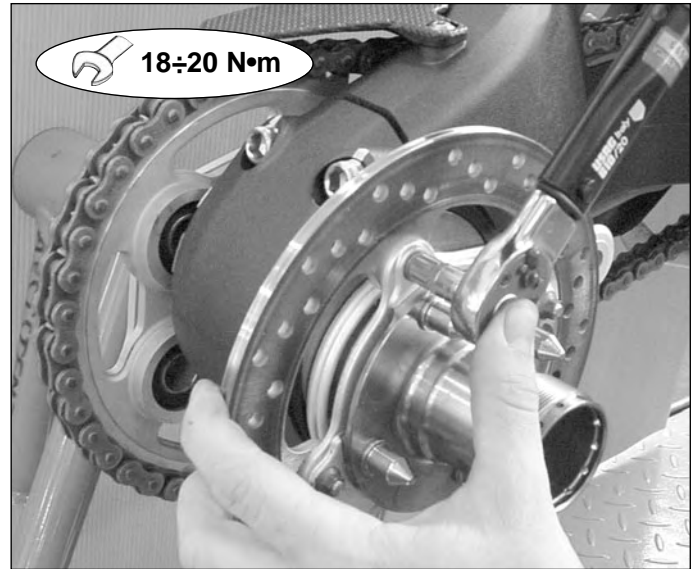

H



Cooling system and lubrication system

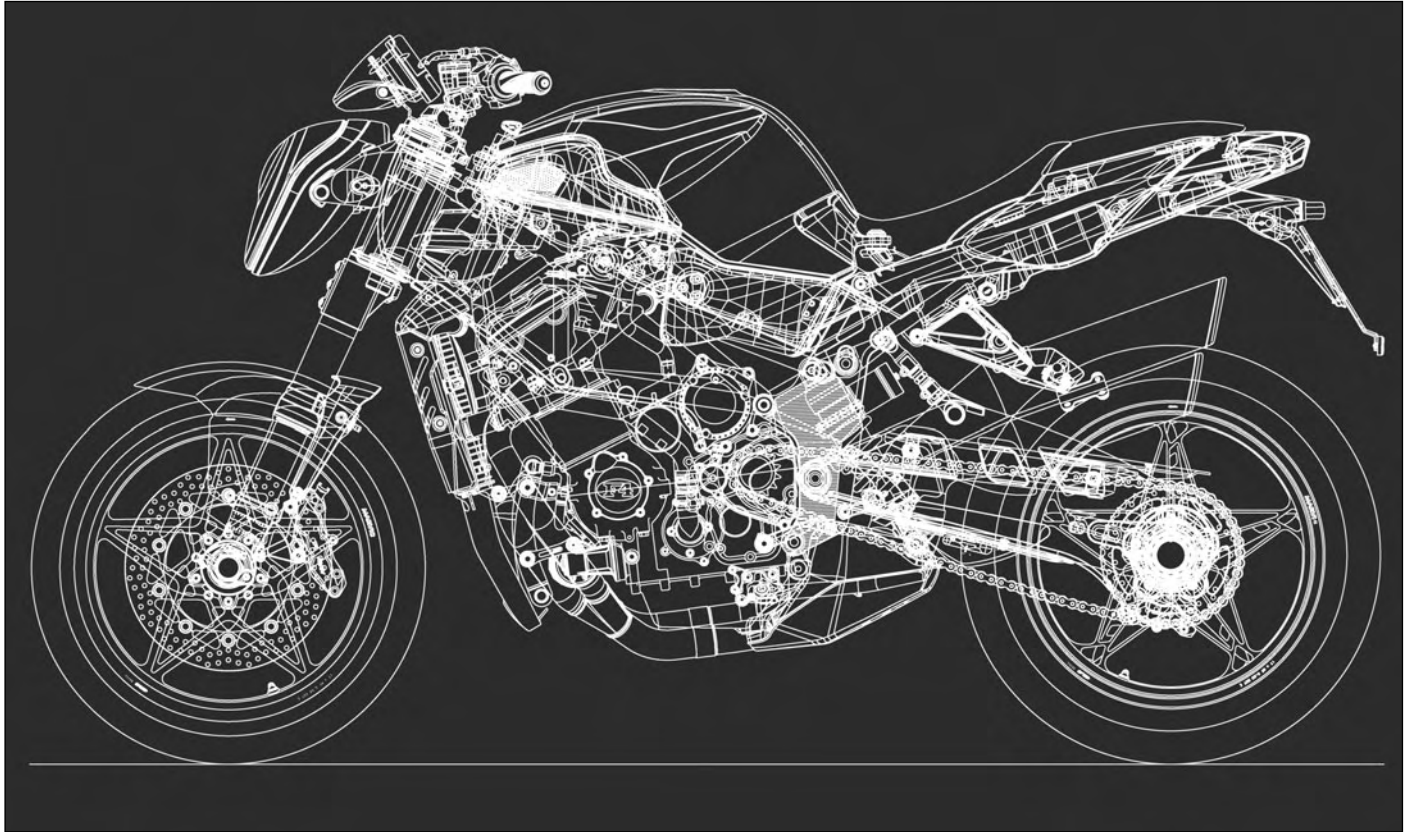

L

SECTION L

Revision 0



SUMMARY

COMPLETE COOLING SYSTEM ASSEMBLY AND LUBRICATION SYSTEM	PAGE 3
COOLING SYSTEM LEAKAGE CHECK	PAGE 4
EXPANSION TANK CAP CHECK	PAGE 4
ENGINE COOLANT EXTRACTION.....	PAGE 5
EXPANSION TANK REMOVAL	PAGE 5
DISASSEMBLING WATER RADIATOR	PAGE 8
DISASSEMBLING ELECTRIC FAN	PAGE 12
CHECKING COOLING FAN STARTER.....	PAGE 13
COOLANT TEMPERATURE SENSOR	PAGE 15
REMOVING THERMOSTAT VALVE	PAGE 16
REASSEMBLING THERMOSTAT VALVE.....	PAGE 18
REASSEMBLING EXPANSION TANK.....	PAGE 20
ASSEMBLING WATER RADIATOR	PAGE 22
REMOVING OIL RADIATOR	PAGE 27
REASSEMBLING OIL RADIATOR	PAGE 31

COMPLETE COOLING SYSTEM ASSEMBLY AND LUBRICATION SYSTEM

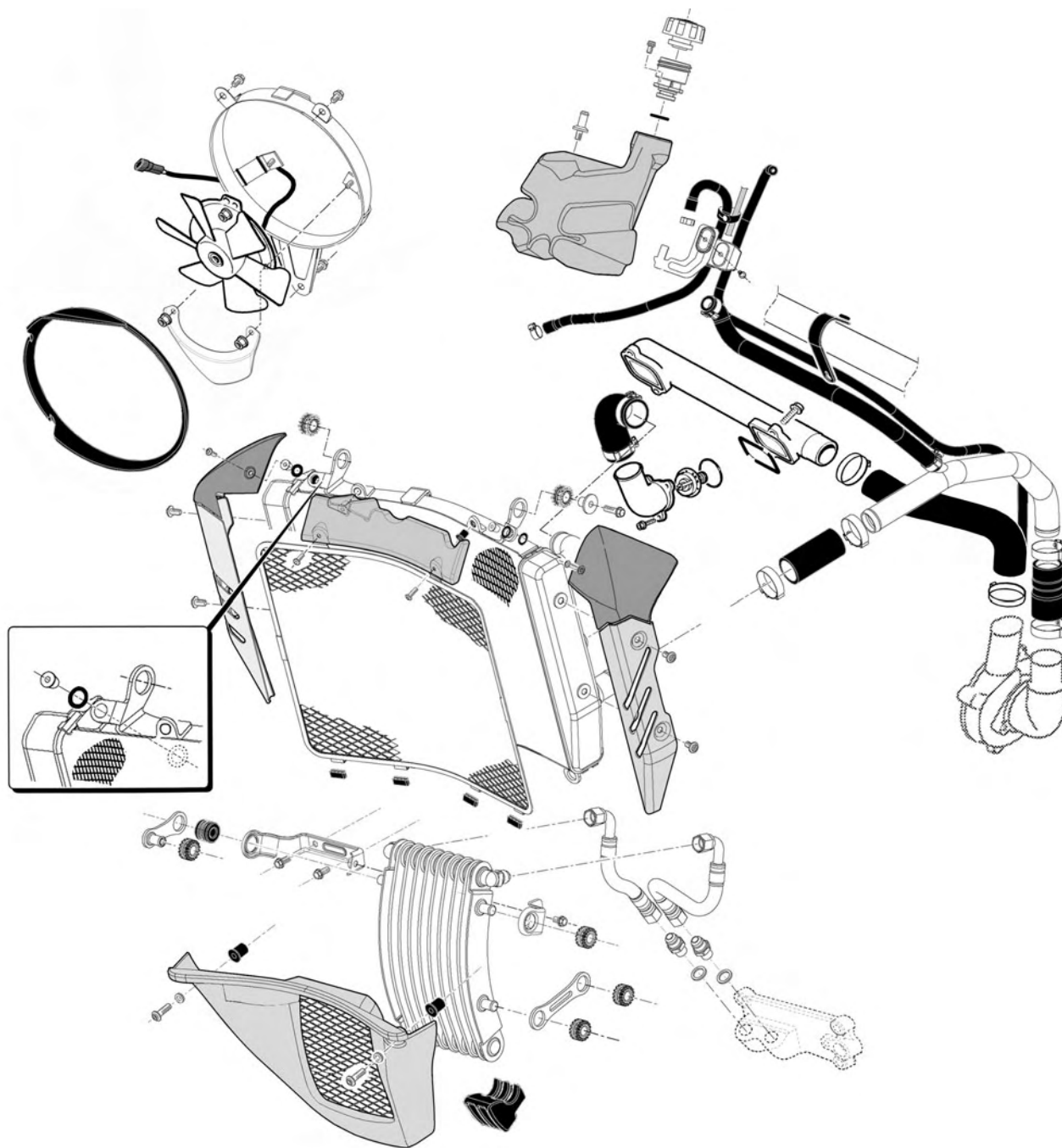

Before checking, disposing of, or overhauling any component relevant to the cooling and lubrication perform some preliminary operations system:

- 1) Let the engine cool down.
- 2) Remove the passenger and pilot seat, right and left side panel, fuel tank and air filter compartment as described in the chapter C "Superstructures".



Cooling system and lubrication system

COOLING SYSTEM LEAKAGE CHECK

Before removing the radiator and discharging the engine coolant, check that the cooling system does not have leakages.

Remove the expansion tank cap and connect the tester (of the type shown in the diagram) to the filler hole.

 **Do not open the radiator cap whilst the engine is hot.**

Apply a pressure of approximately 120 kPa (1.2 kg/cm²) and check that the system maintains the pressure for at least 10 seconds.

If the pressure diminishes within ten seconds means that there is a leak in the system.

If so, check the entire system and substitute the defective/damaged parts.

 **When removing the tester from the filler hole, wrap a cloth around the filler hole to avoid spurts of engine coolant.**

 **Do not exceed the recommended pressure to avoid damaging the radiator.**

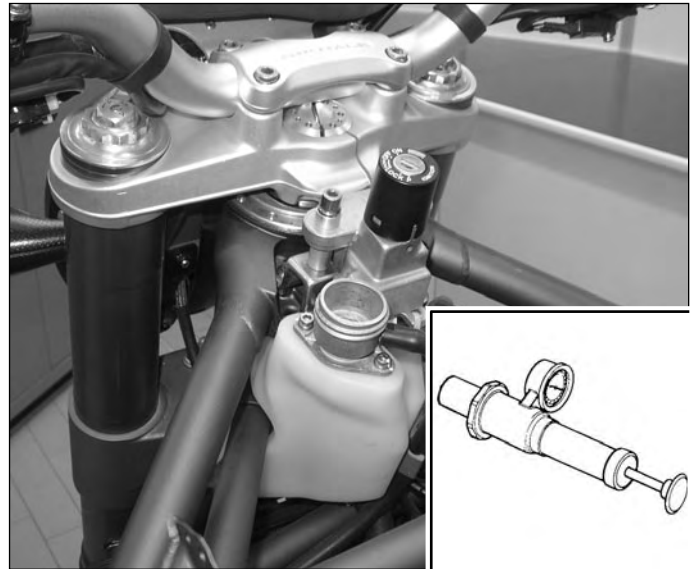

EXPANSION TANK CAP CHECK

Check the release pressure of the radiator cap by utilizing the appropriate tester as follows:

Apply the cap to the tester as indicated and slowly create a pressure by activating the tester.

Ensure that the pressure increase is stopped at 110 ± 15 kPa (1.1 ± 0.15 kg/cm²) and check that with the tester held steady, the pressure is maintained for at least ten seconds. Substitute the cap if the pressure is not maintained for ten seconds.

Radiator cap release pressure: 110 ± 15 kPa (1.1 ± 0.15 kg/cm²)

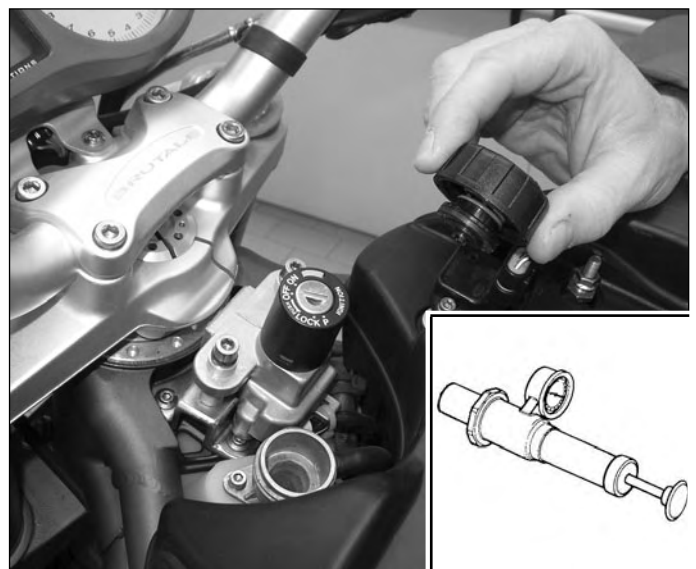

ENGINE COOLANT EXTRACTION

Remove the ignition commutator cover unscrewing the two fixing screws (1).
Open the cap of the expansion tank (2).

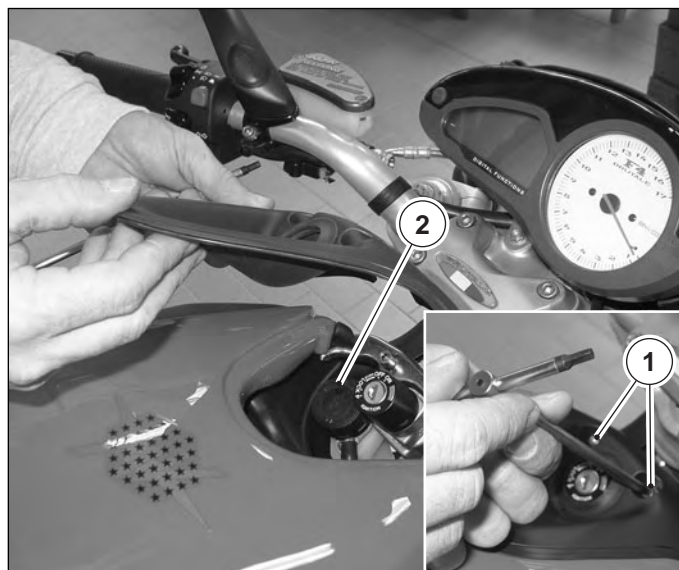

Empty the cooling system of the coolant as follows:

- Place under the engine a container to collect the discharged coolant;
- Remove the discharge screw (1) situated on the water pump (2);
- Make sure the coolant flows into the container.

Wait until all the engine coolant has dripped out of the cooling system.



**Recover the coolant in an appropriate vessel.
Do not drain liquid into the environment.**

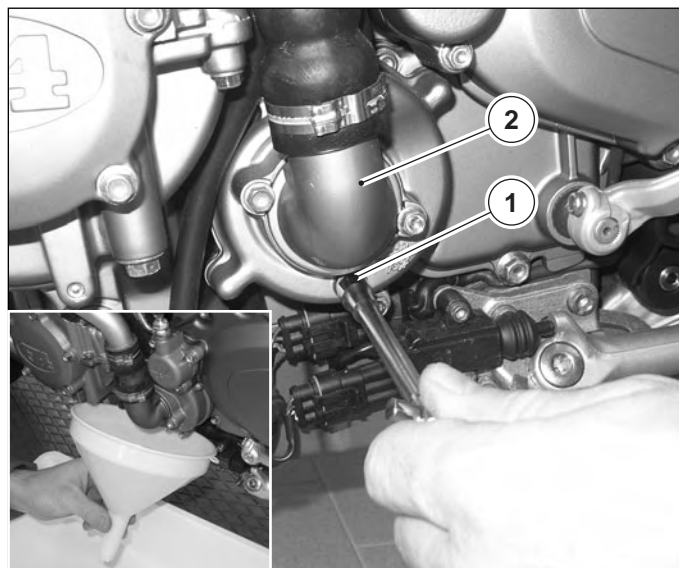

EXPANSION TANK REMOVAL

After having drained the cooling system, as described in the previous paragraph, it is necessary to remove the ignition switch you should remove the **fuel tank** and the **air filter compartment** in advance as described in the Chapter C "Superstructures".
Then remove the ignition switch as follows:

Remove the ignition switch unscrewing the two fixing screws (1).

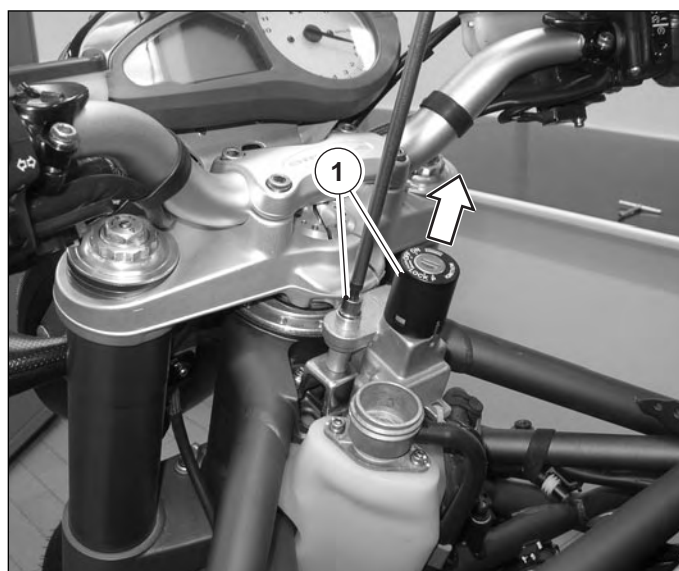



Cooling system and lubrication system

Disconnect the connector (1) of the ignition switch and remove its rubber clamp (2) acting on the right side of the motorcycle.

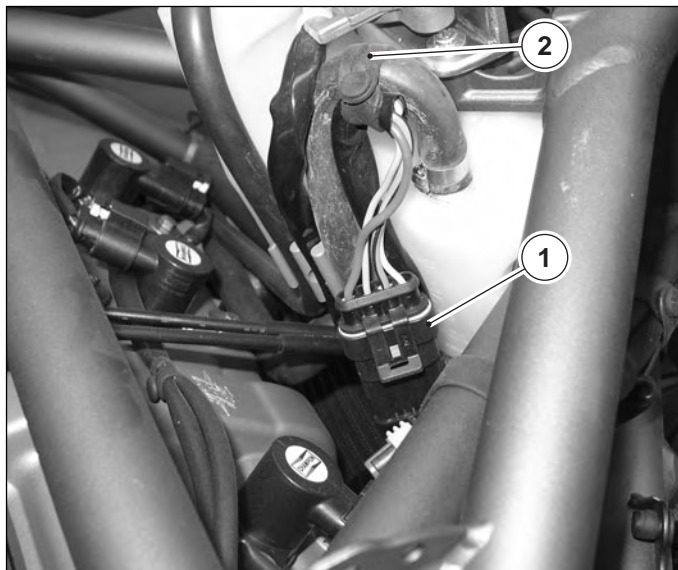

On the right side of the motorcycle remove the clamp (1) connecting water radiator breather pipe to the expansion tank using specific pliers CLIC R 205 and its rubber clamp (2).



Specific tool CLIC R 205

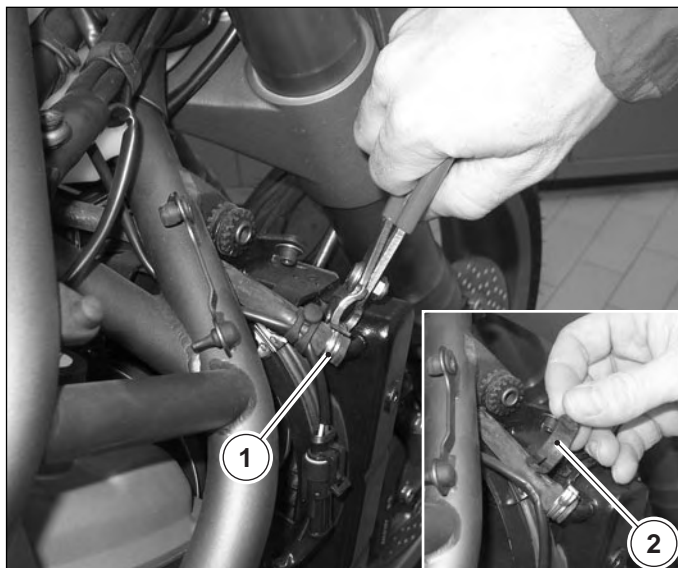

Disconnect the overflow pipe (1) from the expansion tank.

Check the diameter of the tube that has just been removed.

If the external diameter = \varnothing 10.5 mm and the internal diameter = \varnothing 6.5 mm the tube can be reused for the successive assembly.

If the dimensions of the tube are different from those indicated it must be substituted for a new one.

If so, proceed with its complete removal.

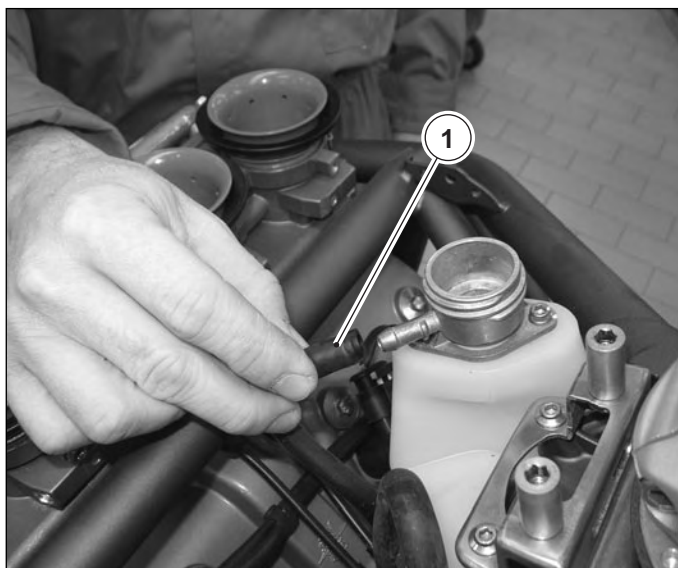



Cooling system and lubrication system

In order to extract the pipe you should release it from the fixing point shown by the arrow in the figure on the side.

Remove the ignition switch support unscrewing the four screws (1).

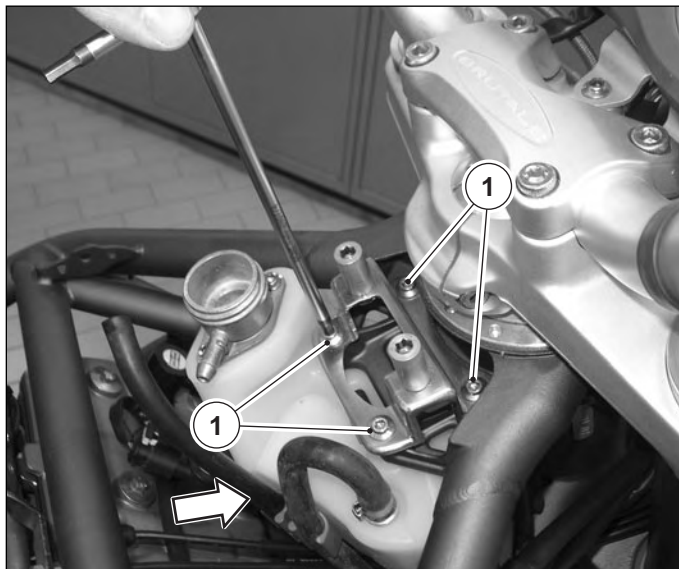

On the left side of the motorcycle remove the clamp (1) connecting the water radiator charging pipe to the expansion tank using a specific pliers CLIC R 205 and its rubber clamp placed near the fluid supply tank.



Specific tool CLIC R 205

Disconnect the water radiator charging pipe (2).

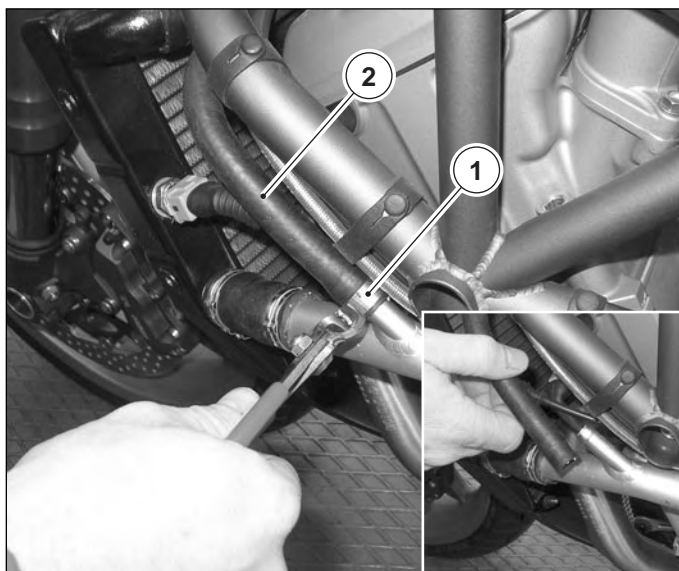

Remove the expansion tank (1) releasing it from its seat on the frame and lifting it in the rearward of the motorcycle.

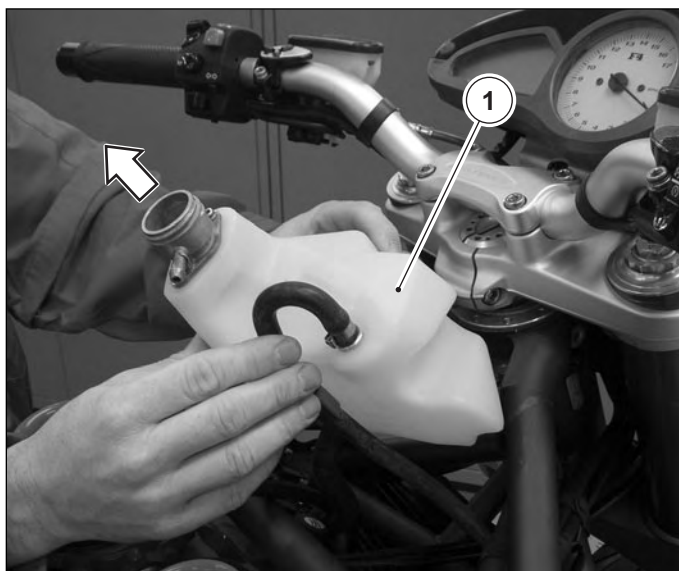



Cooling system and lubrication system

DISASSEMBLING WATER RADIATOR

Remove the upper (1) and side (2) protections of the water radiator unscrewing the respective fixing screws on both sides of the radiator.

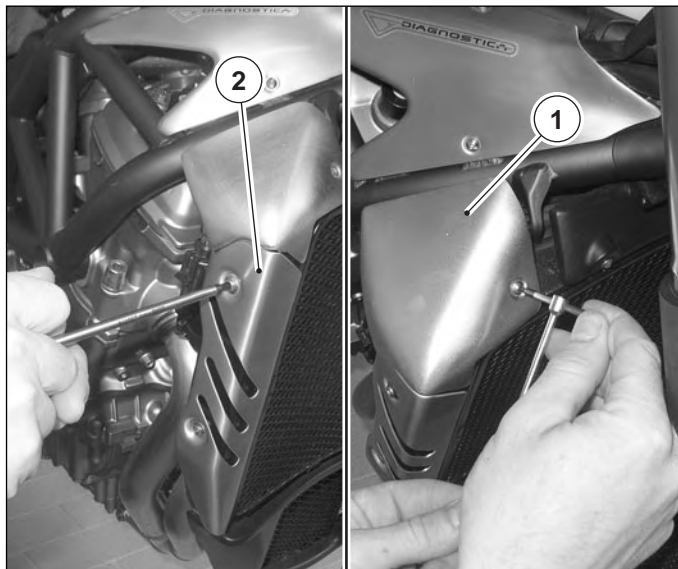

Remove the oil radiator protection (1) unscrewing the two fixing screws.

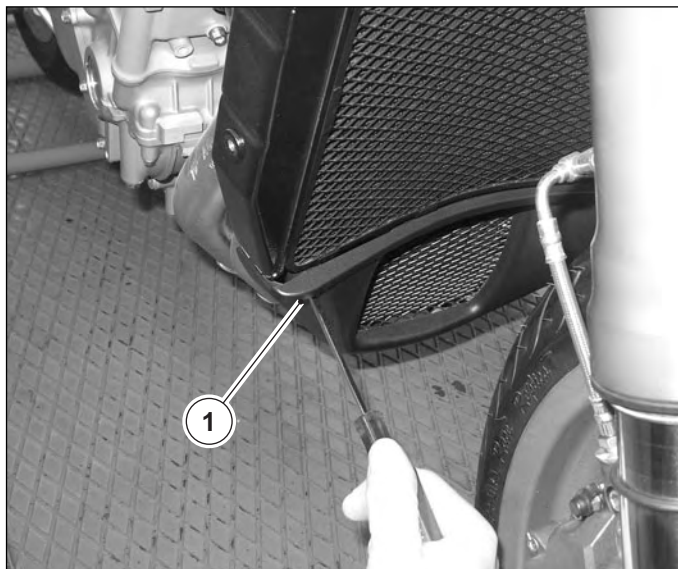

Remove the upper plastic protection (1) unscrewing the two fixing screws.

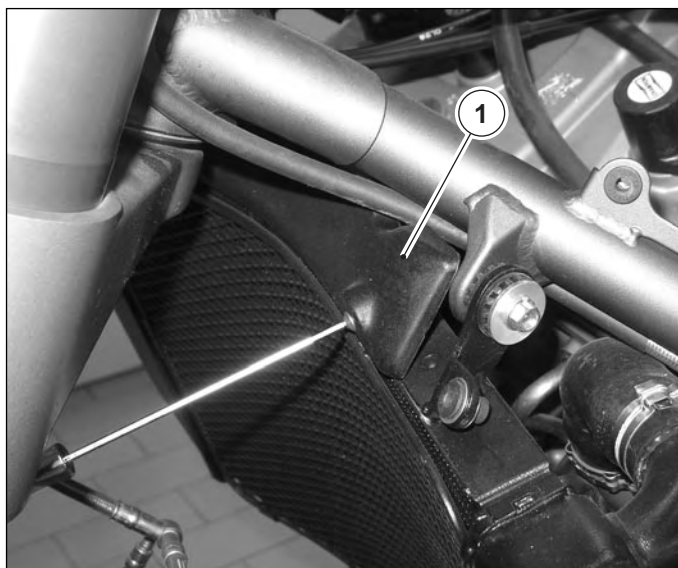



Cooling system and lubrication system

Remove the protective grid (1) taking it out from its seat.

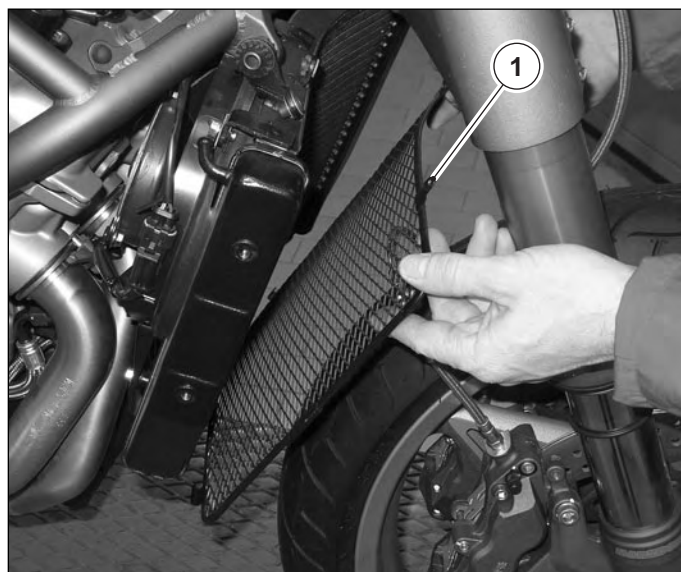

Disconnect the connector (1) of the water radiator electric fan on the right side of the motorcycle.



Disconnect the connector (1) of the water temperature sensor to the instrumentation panel on the left side of the motorcycle.

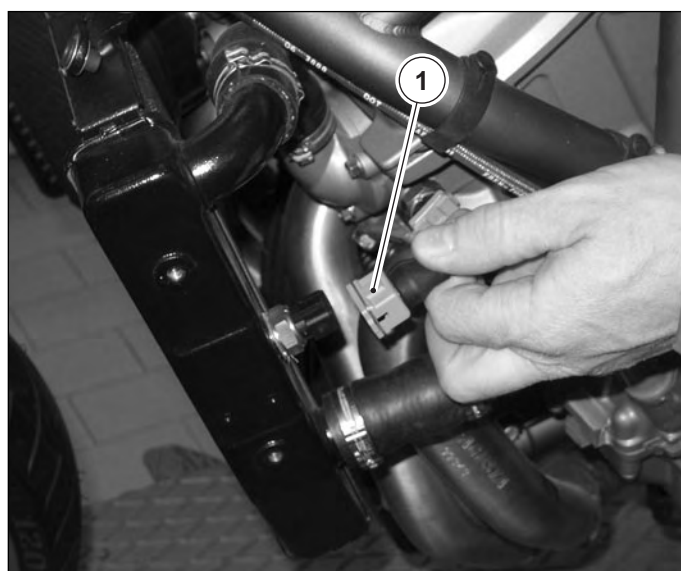

L



Cooling system and lubrication system

Remove the clamp (1) on the water suction pipe coupling from the pump to the radiator using the specific pliers CLIC R 205.

 **Specific tool - pliers CLIC R 205**

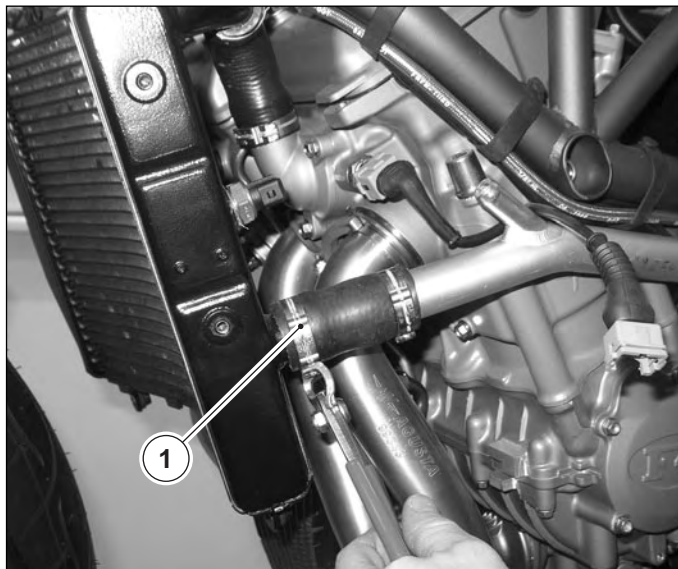

Remove the clamp (1) on the water inlet pipe coupling to the radiator from the thermostat valve using the specific pliers CLIC R 205.

 **Specific tool - pliers CLIC R 205**



Disconnect the fixing link rod on the right side of the water radiator.





Cooling system and lubrication system

Move the radiator towards the front side of the motorcycle in order to release the water suction pipe coupling (1) from the pump to the radiator.



Release the water inlet pipe coupling to the radiator (1) to the radiator from the thermostat valve.

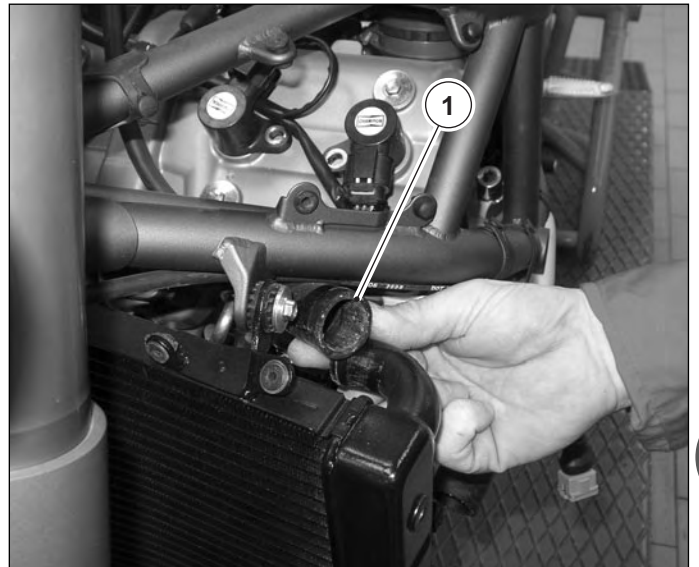

Remove the radiator fixing screws on the left side of the motorcycle.

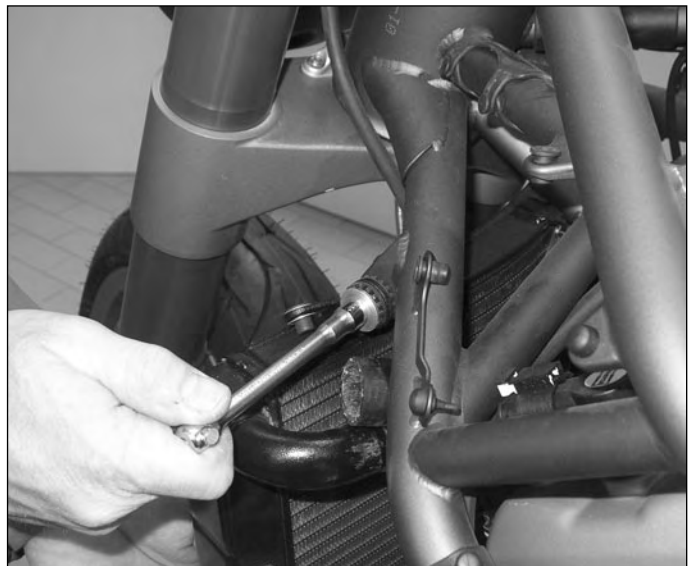



Cooling system and lubrication system

Remove the radiator moving it right in order to release it from the peg (A) on the frame support.

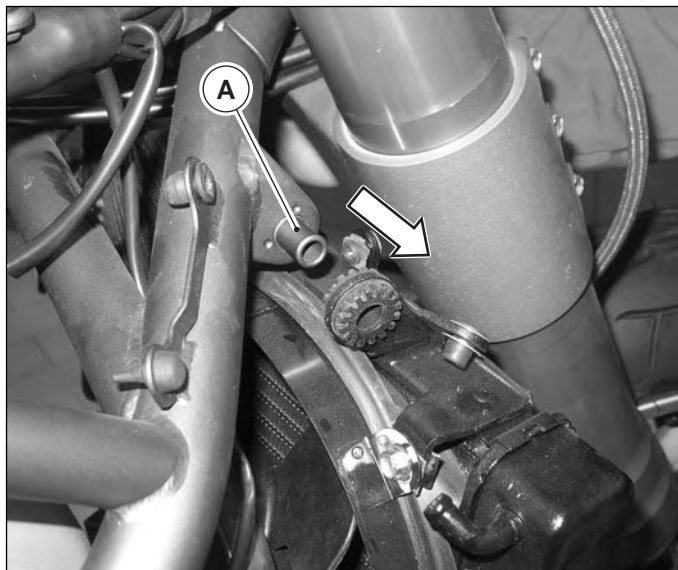

DISASSEMBLING ELECTRIC FAN

Unscrew the three screws (1) and remove the complete fan support.

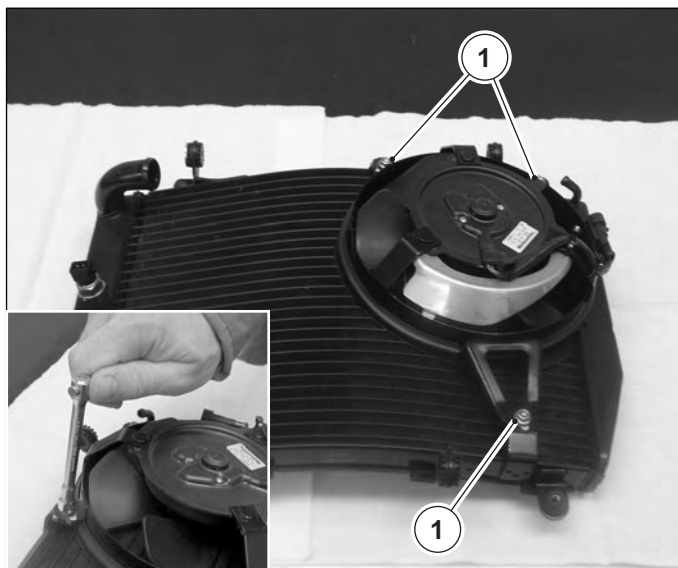

For replacing fan you should remove the three nuts (1) for fixing fan (2) and protecting (3) the support (4).

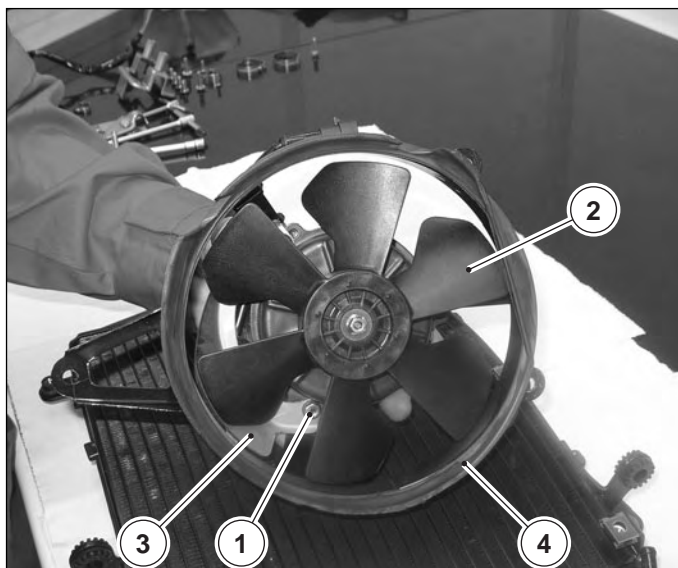

CHECKING COOLING FAN STARTER

In order to verify the efficiency of the electric fan starter, this starter must be connected as shown in the figure by using voltmeter and amperometer.

During the test the starter must be powered.

This test can be carried out on a work surface (connecting a 12V – 9Ah battery) or on board the motorcycle.

The voltmeter is to check that the battery feeds the motor at 12V. When the fan turns at maximum speed the ampmeter should indicate not more than 5 amperes.

If the motor does not turn, substitute the fan motor unit with a new one.

N.B. To carry out the above-indicated test it is not necessary to remove the fan motors from the engine.

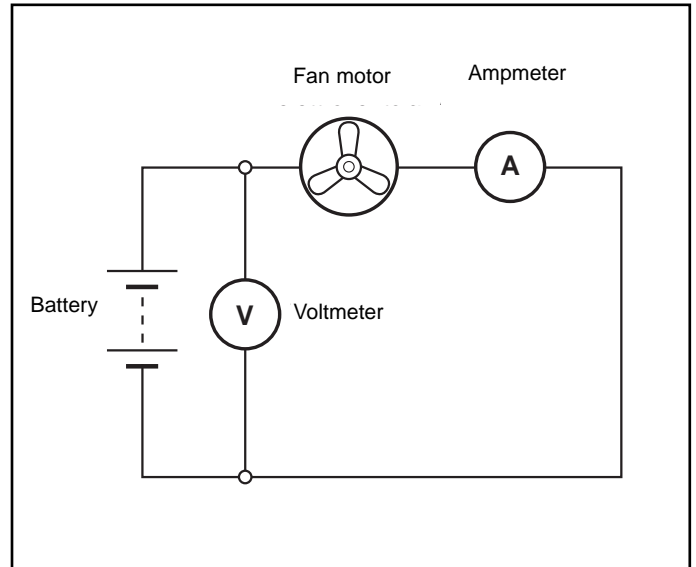

Insert the electric fan (2) on its support (4). Tighten the three fixing nuts (1) putting the protection (3) between support and electric fan.

Torque wrench setting of electric fan nuts: 5 ÷ 6 N•m

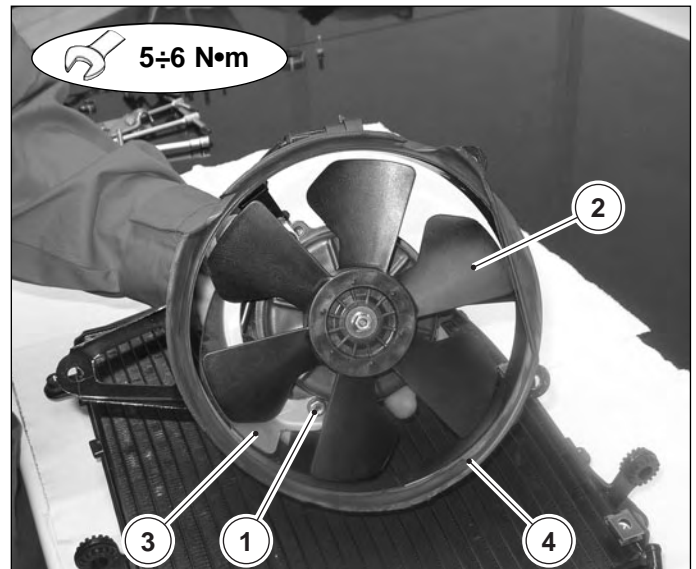

Position the previously assembled electric cooling fan onto the radiator.

Tighten the screws (1) to the prescribed torque wrench.

Torque wrench setting of electric fan support fixing screws: 5 ÷ 6 N•m

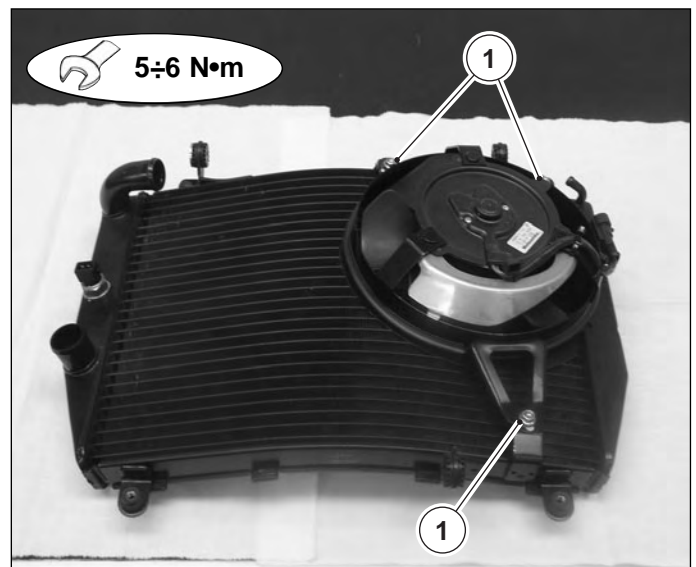



Cooling system and lubrication system

Ensure that the protective sheath (2) is inserted on the fan wiring.

Position the wiring of the upper electric cooling fan as indicated in the figure.

Insert the electrical connector into its tongue support in the area indicated of the fan frame and fix the cable using the appropriate tear clamps (1) as shown in the figure.



To avoid possible contact between the electric lead and the exhaust tube, ensure that the lead is correctly positioned.

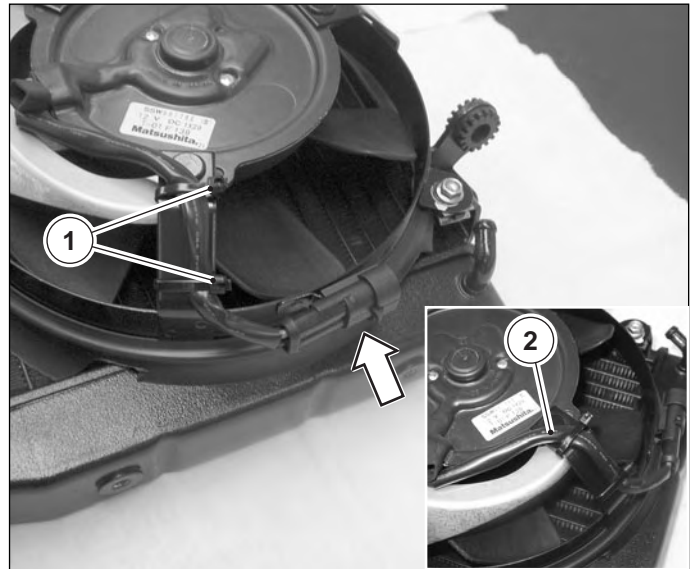

L



COOLANT TEMPERATURE SENSOR

If it is necessary to check the efficiency of the coolant temperature sensor, proceed as follows.

Disconnect the electrical connector as shown in the figure.

Remove the coolant temperature sensor.



Checking water temperature sensor

Check that the resistance of the coolant temperature sensor varies with the temperature as shown.

Carry out the check as follows:

Connect the coolant temperature sensor to an ohm-meter and immerse it into heated oil as indicated.

Heat the oil to slowly raise the temperature and observe the thermometer and the ohm-meter. If the resistance of the coolant temperature sensor does not change as indicated in the table, then the sensor must be substituted.



Special tool 09900-25008: Multi-tester

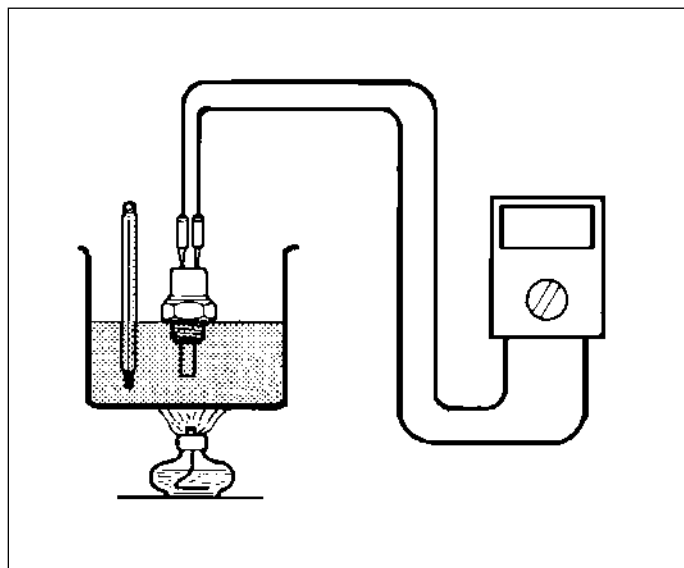

Temperature	Average resistance
20 °C	Approx. 3.747 Kohm
50 °C	Approx. 1.150 Kohm
80 °C	Approx. 0.377 Kohm
110 °C	Approx. 0.153 Kohm
125 °C	Approx. 0.102 Kohm

If the resistance is infinite or quite different from those indicated, the coolant temperature sensor must be substituted.



Cooling system and lubrication system

Assembling water temperature sensor

Before assembling the sensor, apply Teflon tape onto the threaded section of the sensor.

Tighten the coolant temperature sensor to the specified torque pressure.



Coolant temperature sensor torque pressure: 18 N•m



Be careful when inserting the coolant temperature sensor. It could be damaged if it is knocked.

When fully tightened, check that the connector is placed along a horizontal axis with the rear projection placed vertically.

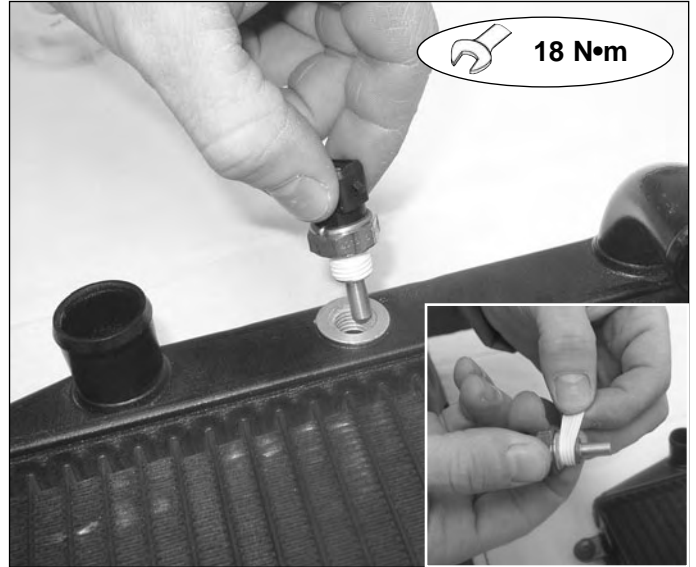

REMOVING THERMOSTAT VALVE

Disconnect the electric wiring from the water temperature sensor (1) to gearcase.

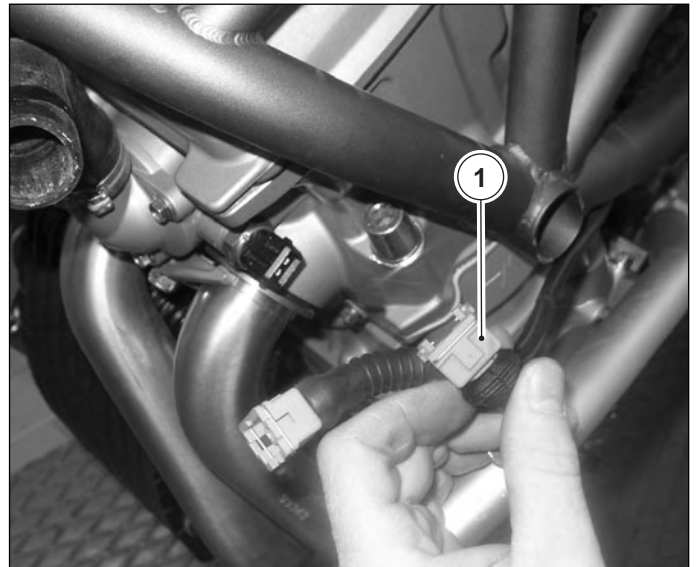

Remove the fixing screws (1) of the thermostat valve cover.

N.B. The figure shows an engine assembly removed from the frame, but you can perform the operation also when the engine unit is assembled.

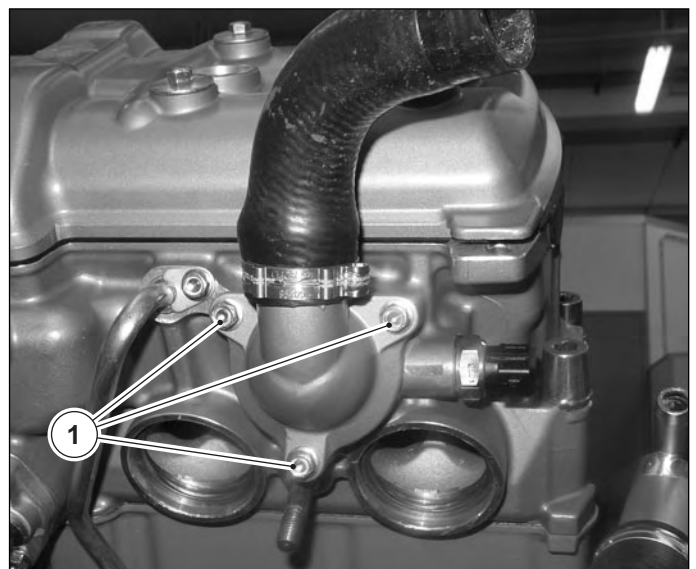



Cooling system and lubrication system

Remove the cover of the thermostat (1).
Remove the thermostat (2).

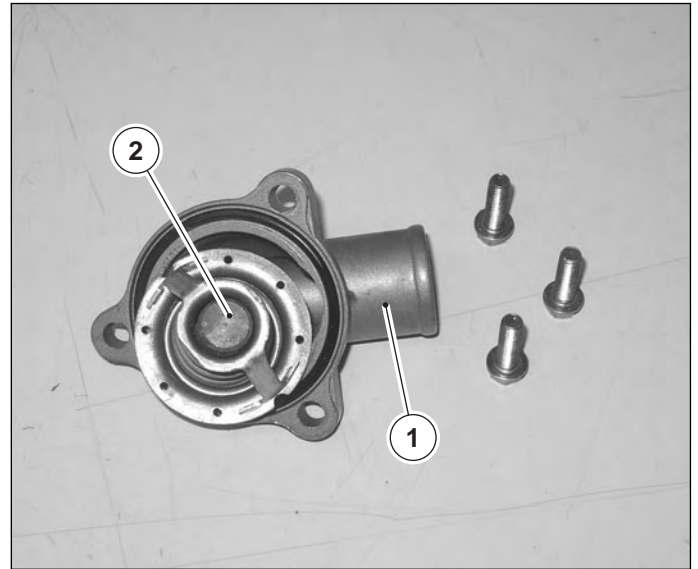

Checking thermostat valve

Check to see if the thermostat pad is damaged.

Check the functioning of the thermostat as follows:

- Suspend the thermostat by a piece of string threaded through the flange as indicated in the figure.
- Immerse the thermostat in water contained in a laboratory glass as indicated in the figure. Ensure that the thermostat is maintained in suspension. Heat the water with a heat source and observe the increase in temperature of the thermometer.
- Observe the temperature at the moment of opening of the thermostat. The temperature at which the thermostat commences to open should be between the indicated values.

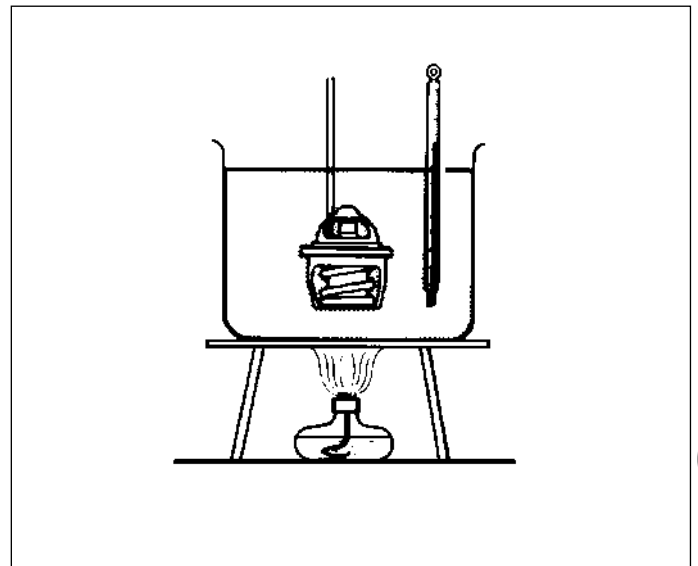

Standard

Thermostat opening temperature:

74.5 - 78.5°C

- Continue to heat the water to increase the temperature.
- When the temperature of the water reaches the specified value, the thermostat should be raised up by at least 7 mm.

Standard

Raising up of the thermostat:

More than 7.0 mm at 90°C

- If the thermostat does not satisfy only one of the requisites (opening temperature and raising up of the thermostat), it must be substituted.



Cooling system and lubrication system

REASSEMBLING THERMOSTAT VALVE

Insert the O-ring (1) in its appropriate seat on the cover of the thermostat.

Check the condition of the O-ring previously utilised.



If the O-ring is not in good condition, substitute it with a new one.

Apply a thin layer of silicone grease.



Recommended grease: Silicone Grease

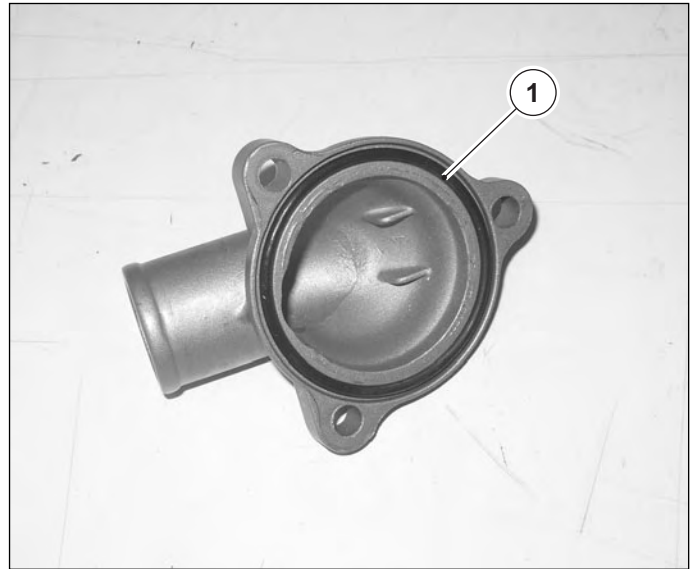

Insert the thermostat (1) into its seat within the cover.

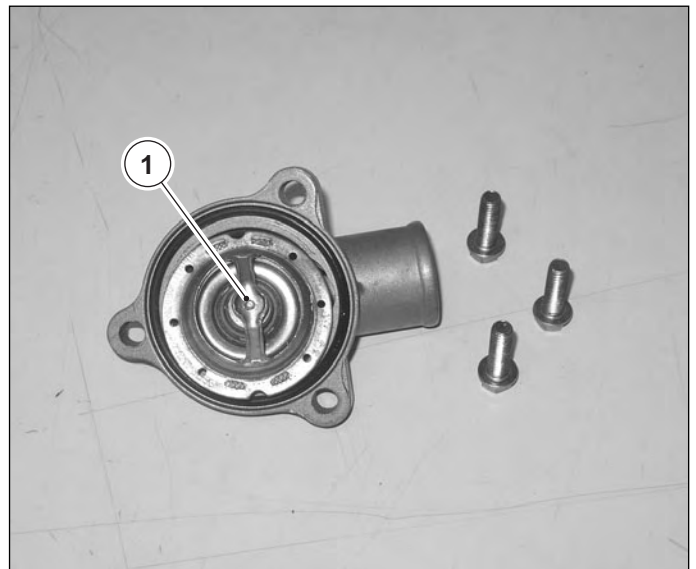

During the assembly of the thermostat ensure that the hole (2) on the external flange of the thermostat is aligned with the curved working (3) on the cover.

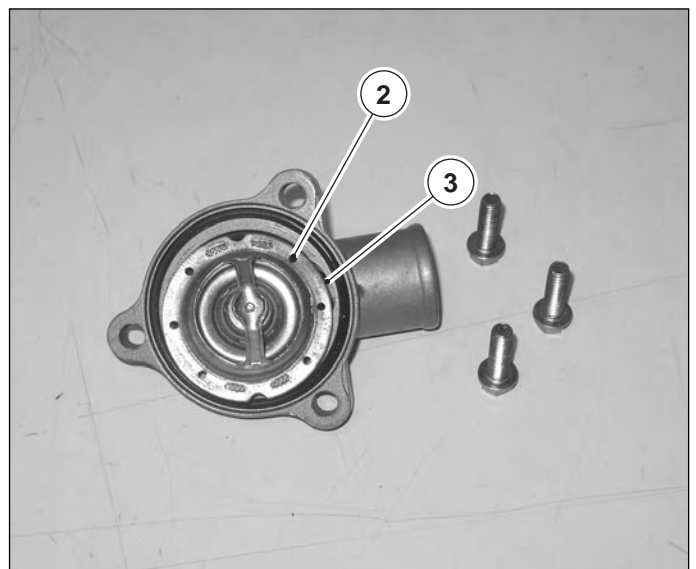



Cooling system and lubrication system

Insert the cover of the thermostat, complete with thermostat onto the engine.

Tighten the three fixing screws (1) to the prescribed torque pressure.



Torque pressure: 10 N•m

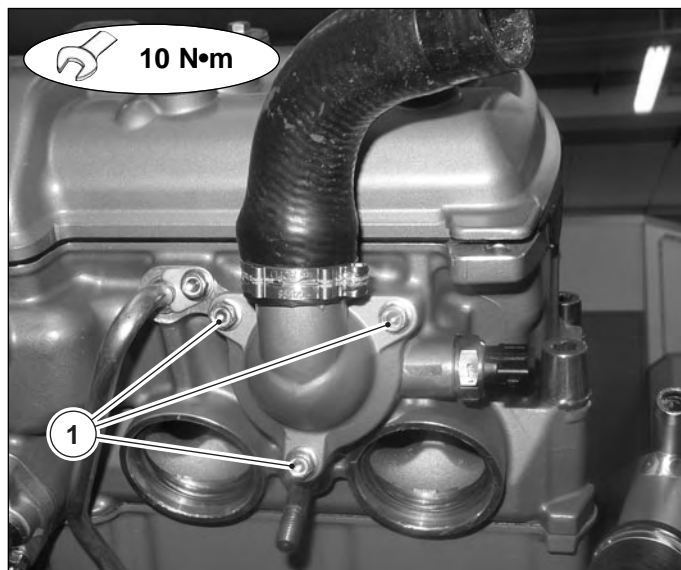

Tighten the H₂O sensor (1) for gearcase, ensuring that the connector is in horizontal or standing position.

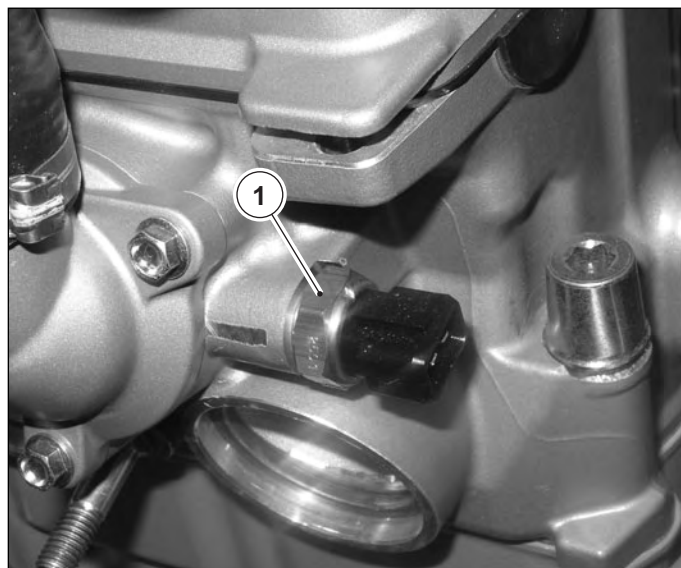

Insert the connector (1) in the thermal switch.

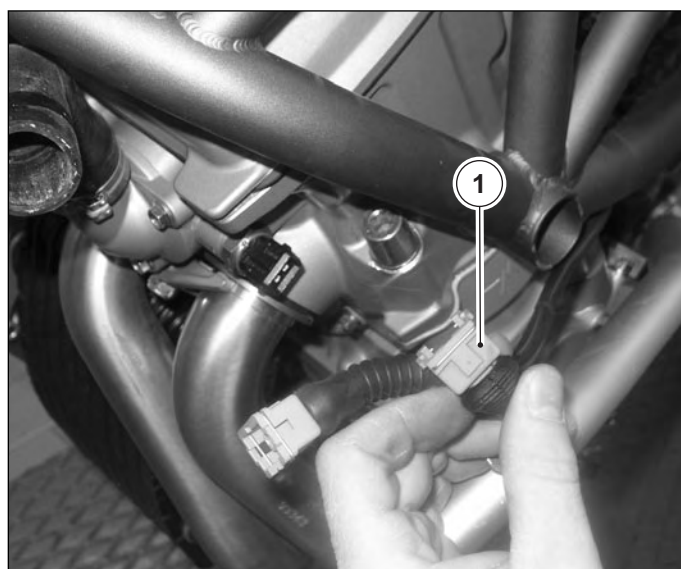

L



Cooling system and lubrication system

REASSEMBLING EXPANSION TANK

Position the tube in respect of the expansion tank as indicated in the figure.

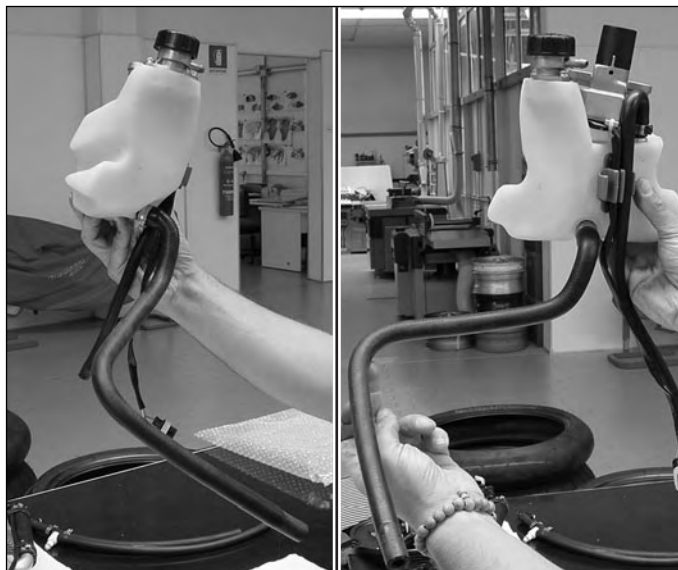

Position the expansion tank on the frame; if the operation is difficult, slightly turn the tank clockwise.

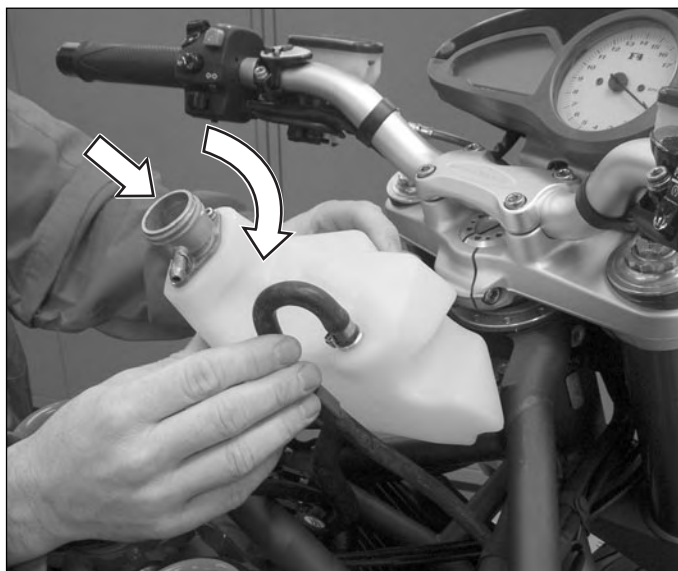

Insert the radiator water breather pipe (1) and the overflow pipe (2) inside the seats on the plastic clip (3).

Reassemble and fix the ignition switch fixing support (4) using the four screws (5).

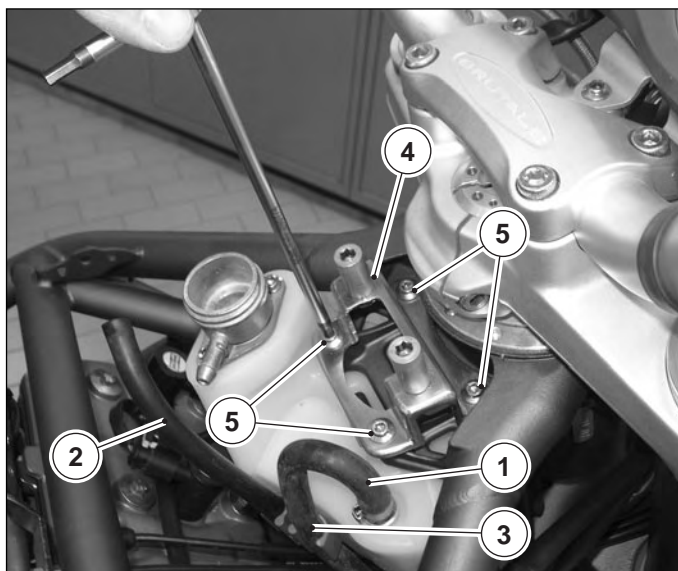



Cooling system and lubrication system

If the overflow pipe had been previously removed, see to put it again and fix it using the three rubber clamps (1) as shown in the figure.

Ensure that the placement follows the figure and includes also the clutch control piping (2).

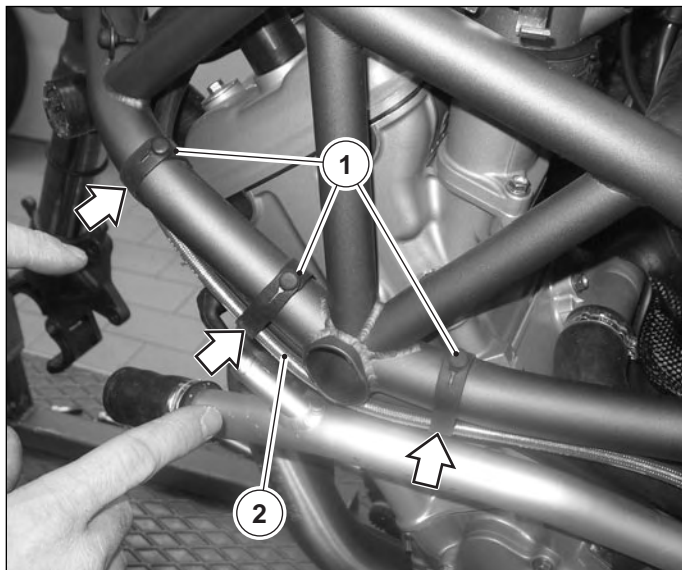

Put the overflow pipe (1) on the nozzle of the expansion tank cap (2) again.



Assemble the ignition switch (1) securing it on the fixing support using the two screws (2).

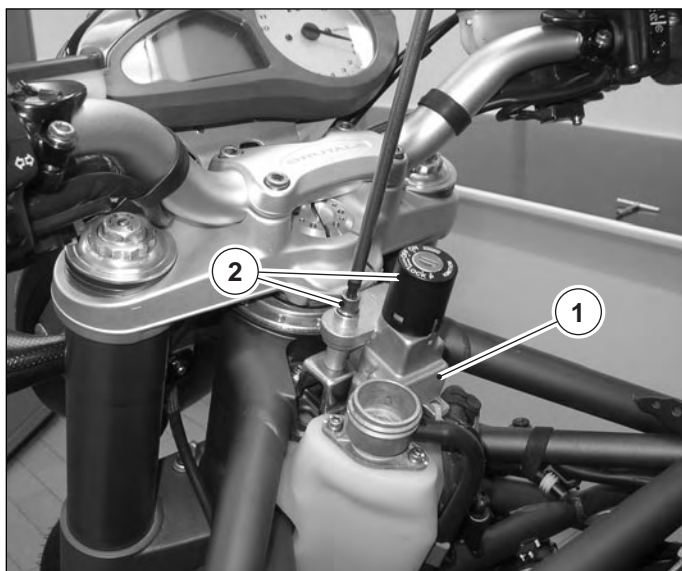



Cooling system and lubrication system

On the left side of the motorcycle, insert the water radiator connecting pipe (2) to the expansion tank. Secure it using a clamp (1) CLIC R 205 with relevant specific pliers.



Specific tool CLIC R 205

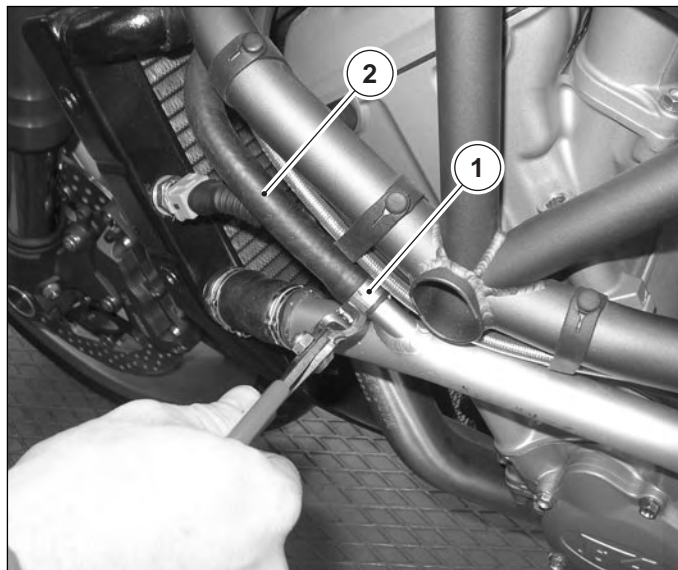

Reconnect the connector (1) with the main wiring connection. Secure the ignition switch wiring to the radiator breather pipe using the rubber clamp (2).

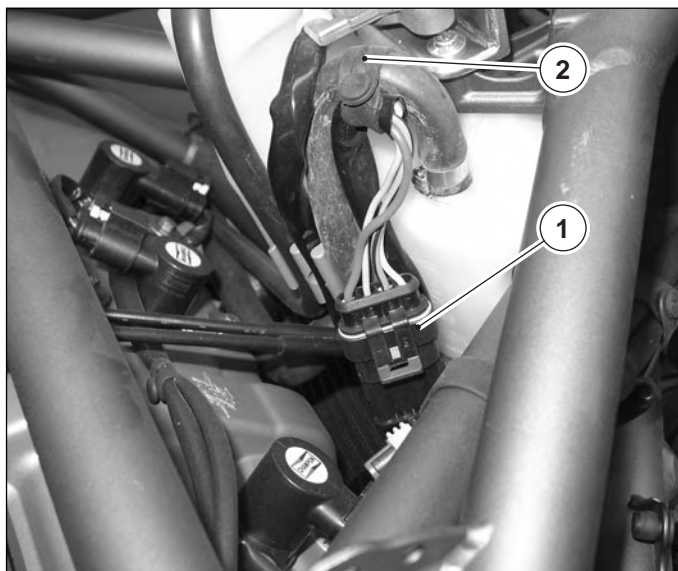

ASSEMBLING WATER RADIATOR

On the right side of the motorcycle insert the radiator right support equipped with rubber bulb in the frame peg (A).

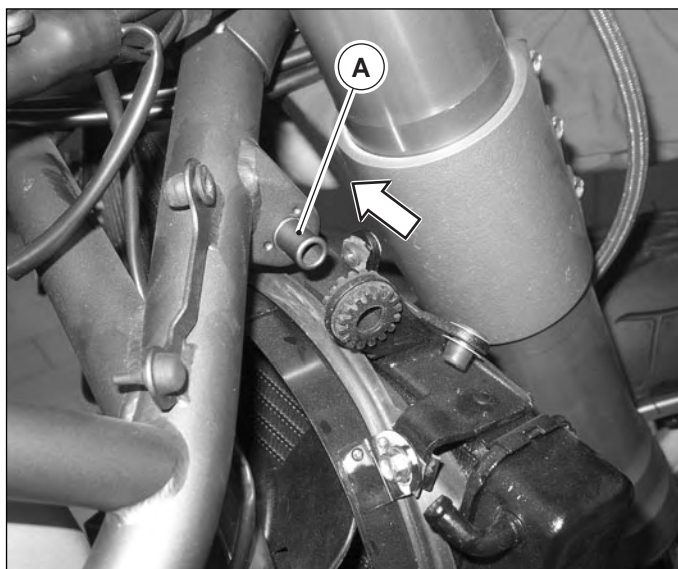





Cooling system and lubrication system

On the left side of the motorcycle insert the radiator fixing screw and tighten it to the prescribed torque wrench.

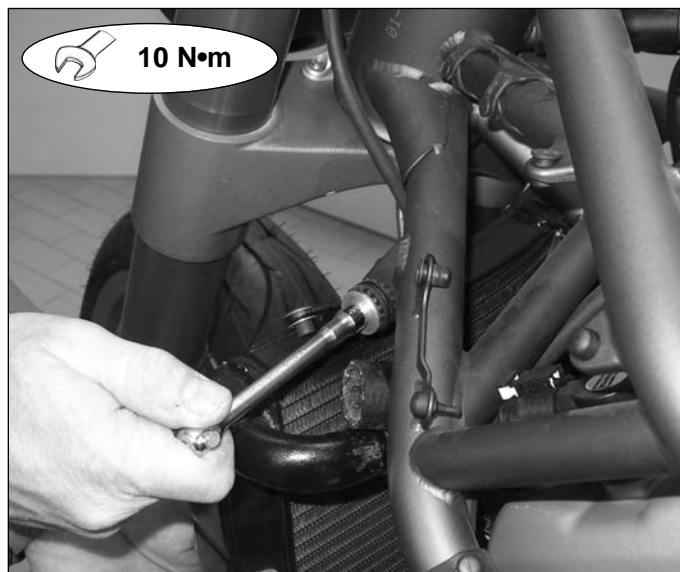
 **Torque wrench setting of the radiator fixing screw: 10 N•m**



Insert the delivery pipe coupling that connects the thermostat valve with the radiator. Secure it using a clamp CLIC R 96 300 (white).

 **Specific tool - pliers CLIC R 205**



Insert the return pipe coupling that connects the radiator with the water pump. Secure it using a clamp CLIC R 96 300 (white).

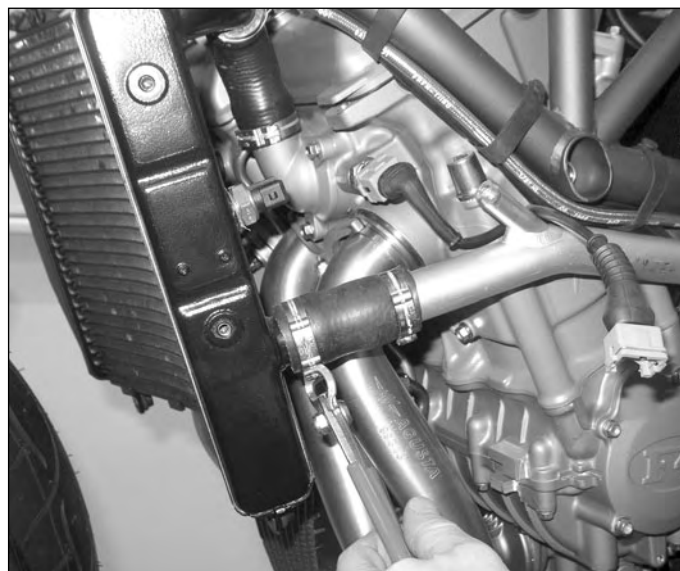



Cooling system and lubrication system

On the right side of the motorcycle connect the electric fan connector (1) with the main wiring.



Always on the right side of the motorcycle insert the breather pipe (1) on the radiator nozzle. Secure it using a clamp CLIC R 96 120 (black). Connect both the pipe and the electric fan wiring by using a rubber clamp (2).



Specific tool - pliers CLIC R 205

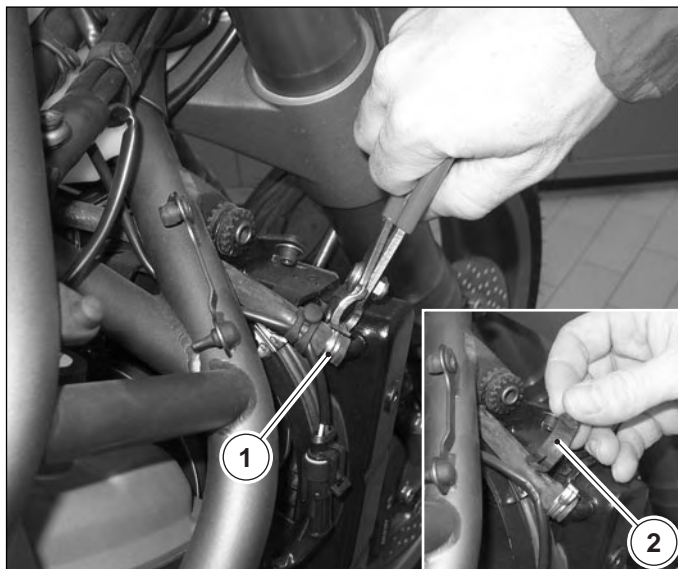

Assemble the protective grid (1) inserting it in its seat.

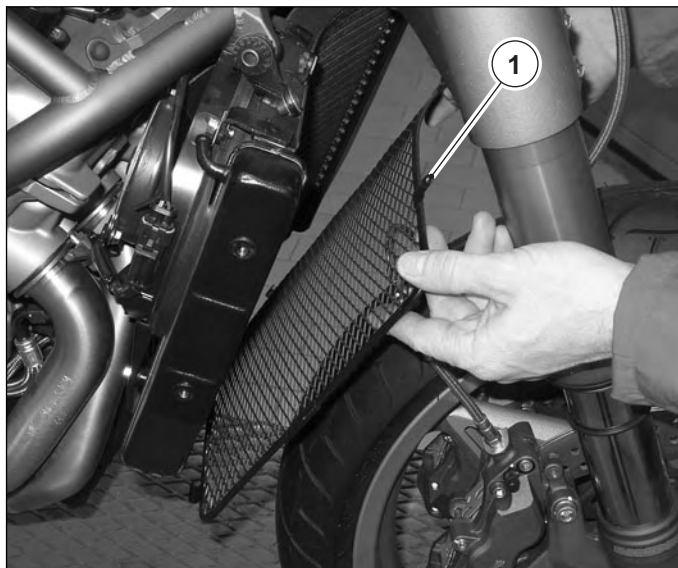



Cooling system and lubrication system

Assemble the plastic upper protection (1) and secure it using the two fixing screws.

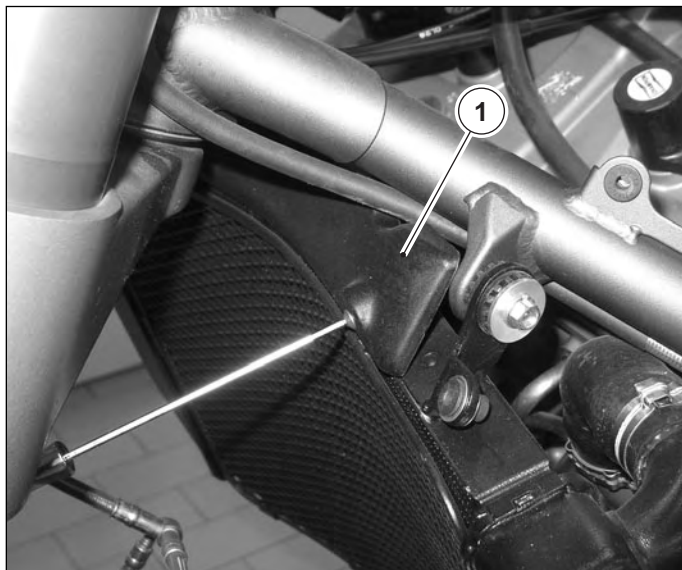

Assemble the side (2) and upper (1) protections securing them on the radiator using the respective fixing screws.

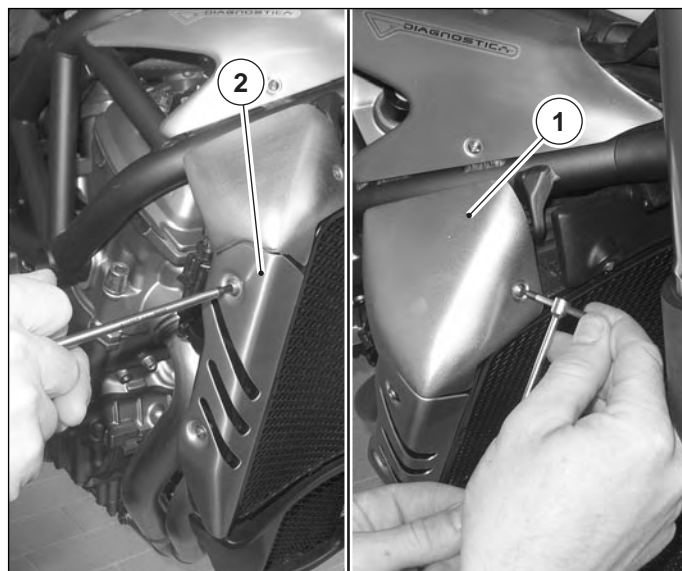

Perform the same operation for assembling the oil radiator protection.

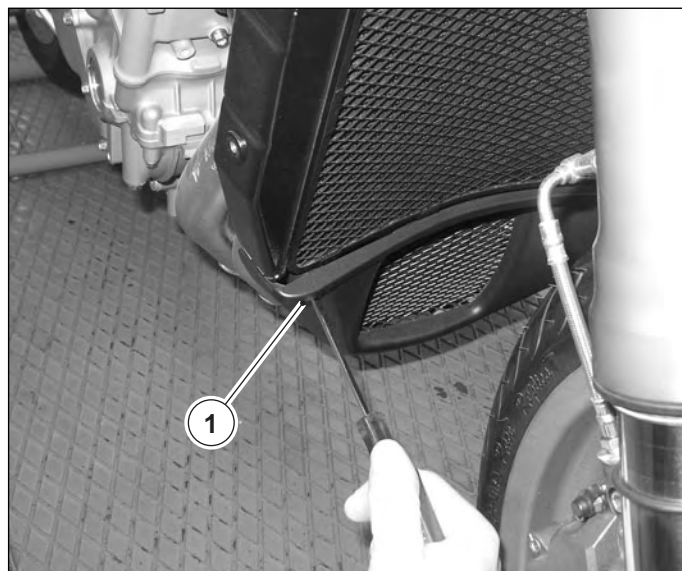



Cooling system and lubrication system

Fill the system using the appropriate fluid.

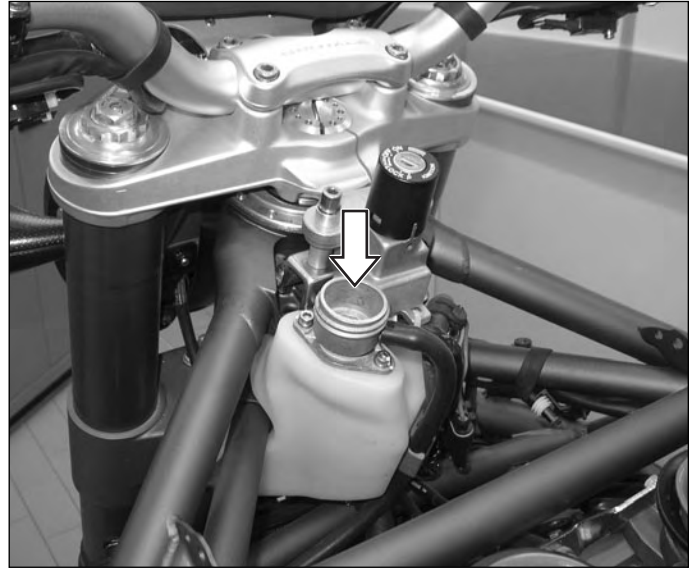

Fill until the notch indicating the **MIN** level is reached.
Tighten the sealing cap of the expansion tank.



For assembling repeat the same phases described for disassembling the components, but reversing the order.

Reassemble the following components in order:

- Air filter compartment
- Fuel tank





Cooling system and lubrication system

Verify the coolant level inside the expansion tank again.

It must reach the line shown in the figure, keeping slightly over the **MIN** reference.

If the level is lower than the line shown, reset it adding new liquid from the filling cap; restart the engine until the temperature is reached and wait for the fan comes into operation at least twice. Shut off the engine and wait for the temperature falls; finally perform the definitive check of the coolant level.

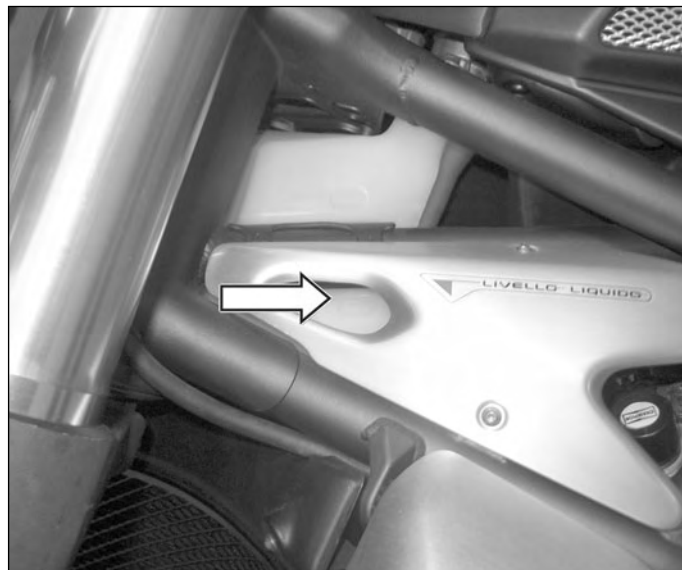

Complete the motorcycle assembly.



REMOVING OIL RADIATOR

Before removing the oil radiator you should completely drain the lubrication system.

Put an appropriate vessel under the engine.

Remove the oil drain plug (1).



**Recover the coolant in an appropriate vessel.
Do not drain liquid into the environment.**

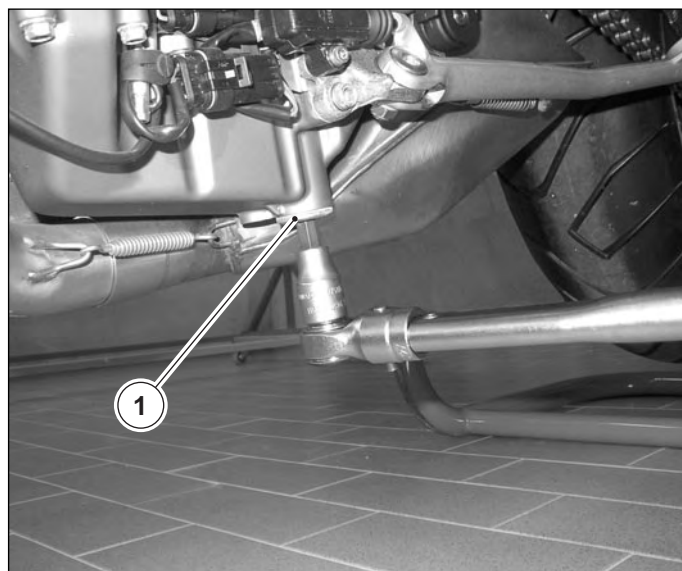



Cooling system and lubrication system

Remove the filling cap (1) on the right side of the motorcycle in order to facilitate the oil spill.
Wait for the complete draining of the lubrication system.

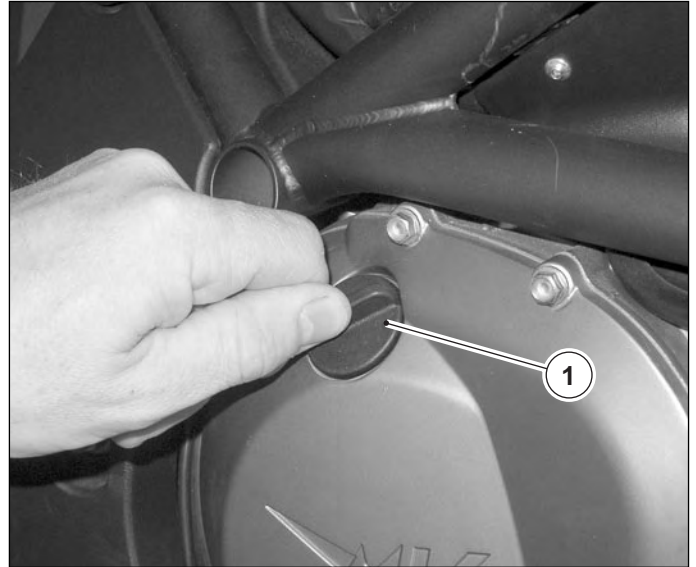

Remove the oil radiator protection unscrewing the two fixing screws.



Remove the exhaust manifolds of the cylinders 1-2-3-4 unscrewing the fixing nuts of the fixing flange (1) from the cylinders.

 **During this operation pay attention to the exhaust pipes in order to avoid scorching if the engine is still hot.**

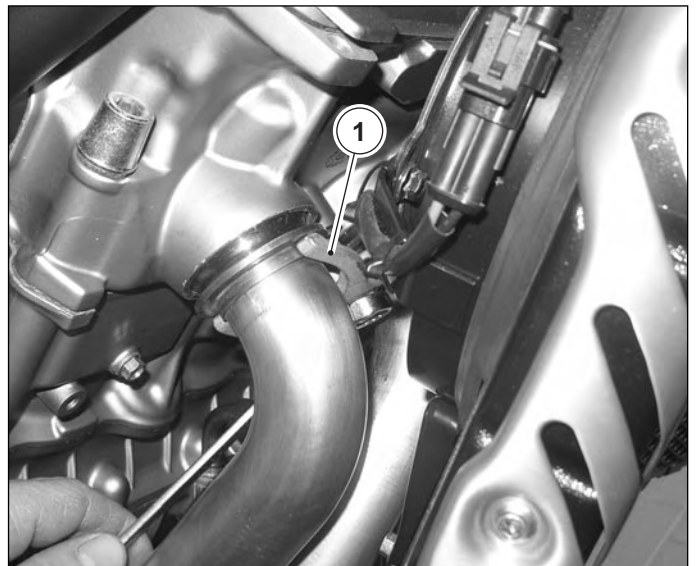

Release the junction spring (1) between compensator and manifold of cylinders 3 and 4.

Remove the manifold of cylinders 3 and 4.

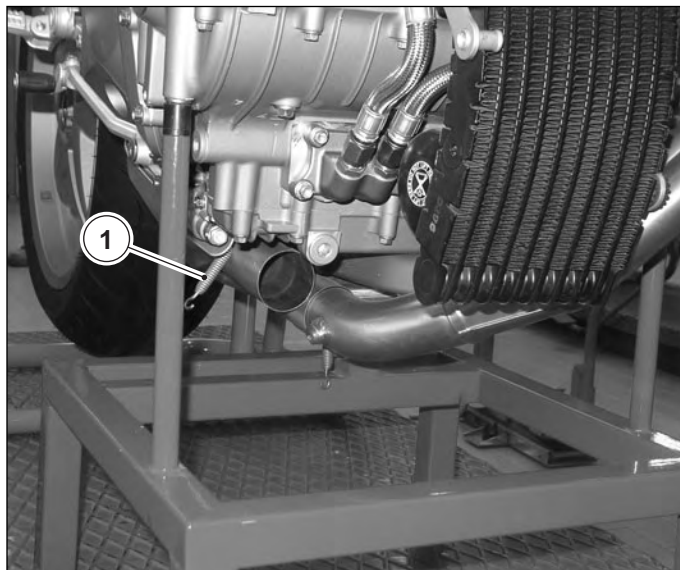

Release the junction spring (1) between compensator and manifold of cylinders 1 and 2.

Remove the manifold of cylinders 1 and 2.

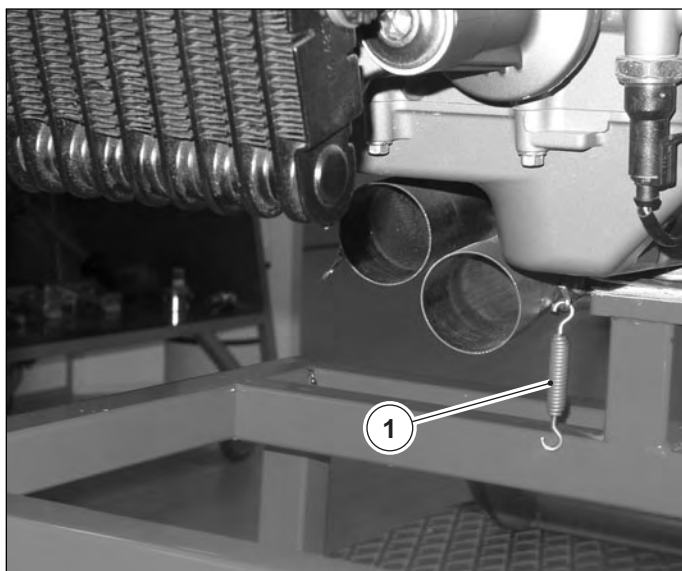

 **Only if it is necessary replacing the oil radiator, perform the following operation.**

Remove the oil delivery and return pipings connected with the nipples of the oil piping support unscrewing the fixing nuts.

 **If the oil radiator should be only removed from its position instead of being replaced, don't intervene either on pipings or on unions.**

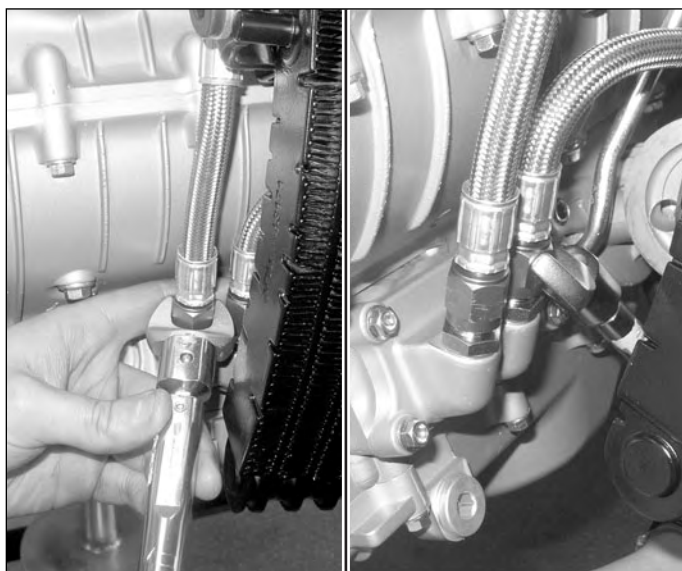



Cooling system and lubrication system

Remove the engine/ radiator support fixing screw placed on the left side.

N.B. This figure and the next ones show an engine assembly which the water radiator has been removed from; but the described operations can be performed also when the radiator is assembled.



Disconnect the engine/radiator anchor rod (1) on the left side.

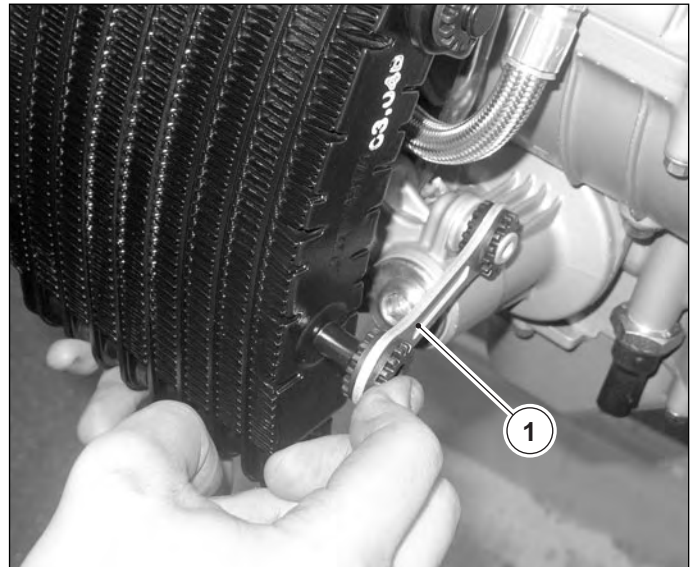

Remove the oil radiator moving it from right to left in order to release the support peg inserted in the rubber bulb support (1) on the right side.

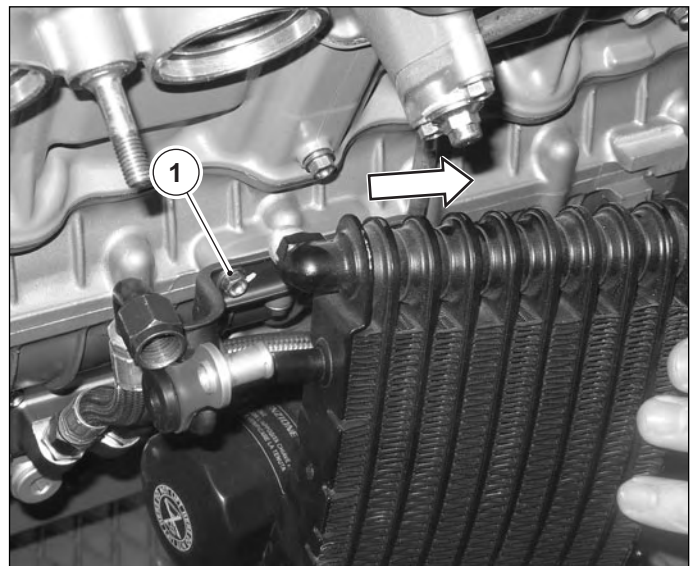



Cooling system and lubrication system

REASSEMBLING OIL RADIATOR

Insert the support peg in the support (1) on the right side making the oil radiator move from left to right.

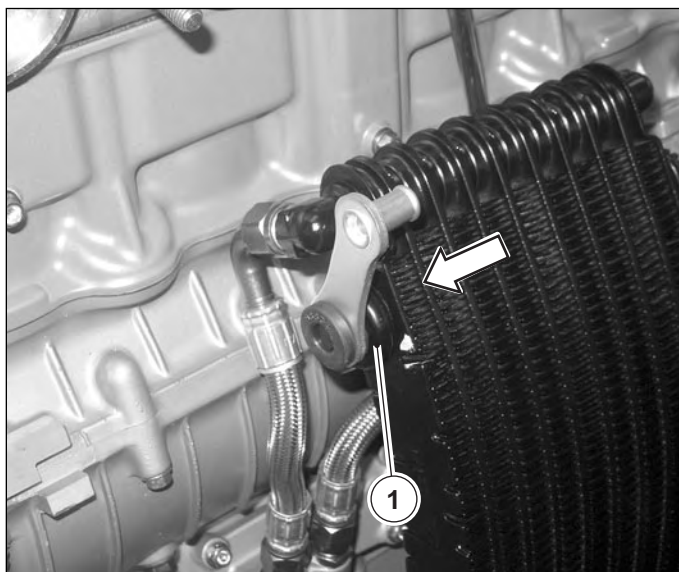

Connect the engine/radiator anchor rod (1) on the left side.

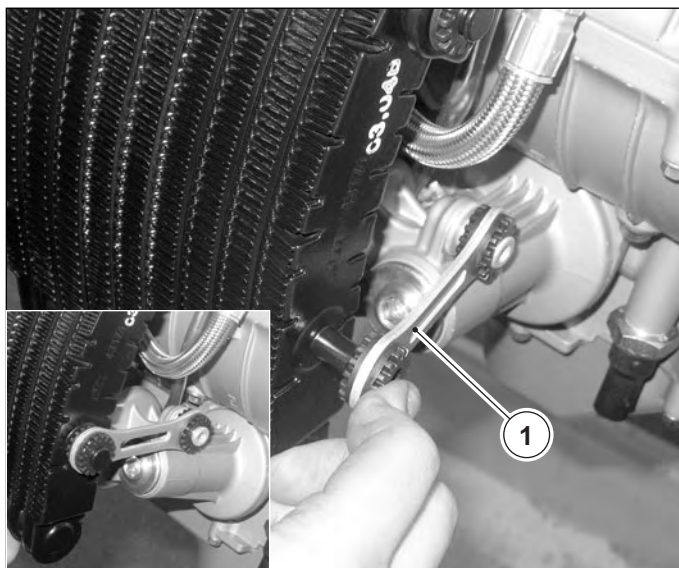

Put the radiator/engine support on the left side again and secure it tightening the screw.





Cooling system and lubrication system

 If pipings and unions had been removed from the radiator, reassemble carefully. Lubricate the union threads using engine oil. Tighten pipings and unions to the prescribed torque wrench.

Reconnect the oil delivery and return pipings with the nipples of the oil pipings support flange lubricating previously the nipple threads placed on it by using engine oil.

 **Lubricate using engine oil**

Tighten the pipe fixing nuts to the radiator to the prescribed torque wrench.

 **Torque wrench setting: 18 ÷ 20 N•m**

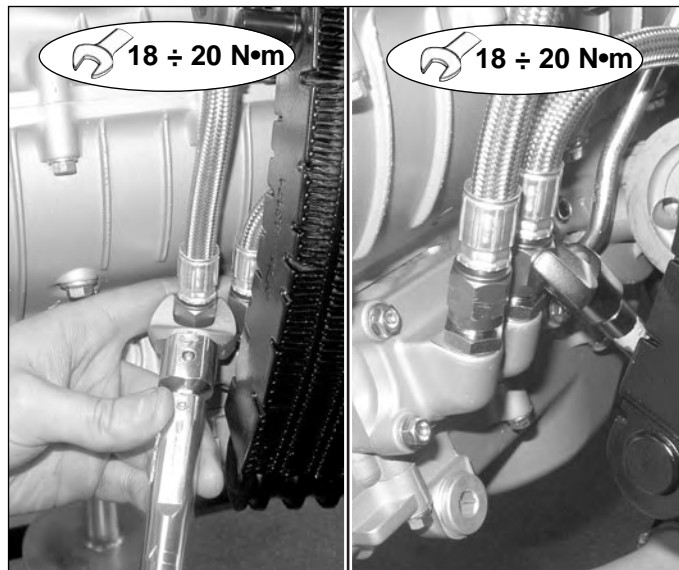

Reassemble the exhaust manifolds of the cylinders 1-2-3-4.

N.B. In order to facilitate the reassembly of the manifolds, you should place the fixing flange before placing manifolds on the engine. Insert the flange inside and then turn it, at last put the manifold flange assembly on the fixing stud.

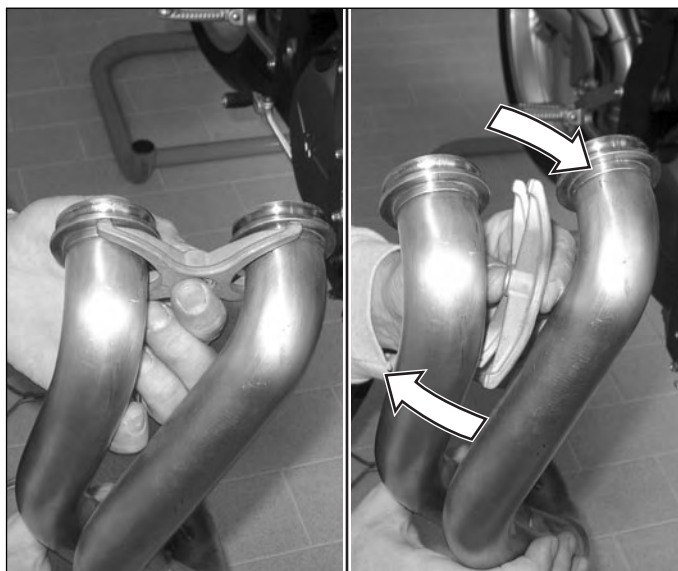

Insert the exhaust manifolds first on their seat on the compensator and then secure them by the flange (1) to the cylinders tightening the nut.

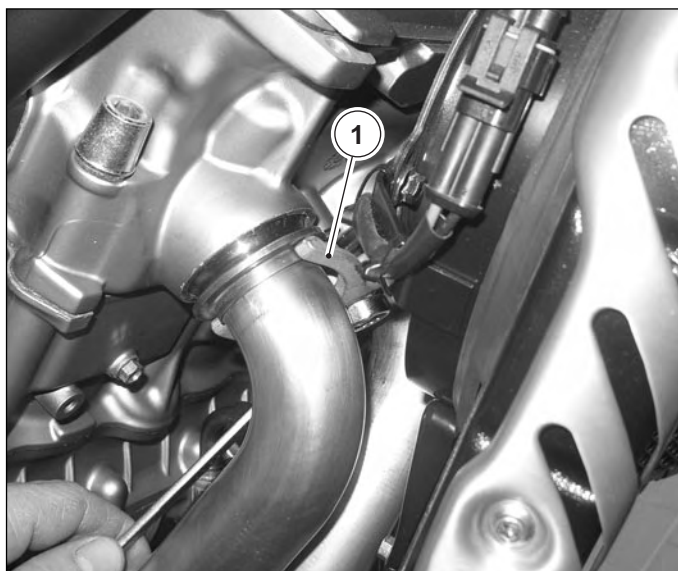

Refasten the junction springs (1) between compensator and manifolds of cylinders 1-2-3-4.

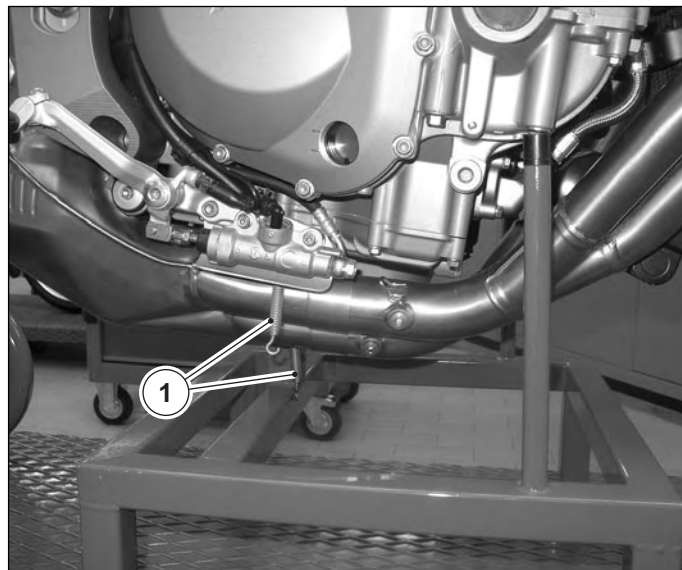

Reassemble the oil radiator protection securing it by the appropriate screws.



Before reassembling the plug, verify the complete cleaning and the good condition of the seal.

On the oil drain plug there is a magnet for attracting any ferrous residuals which could form in the engine during the rotation.

Reassemble the engine oil drain plug and tighten it to the specific torque wrench.



**Torque wrench setting for oil drain plug:
35 N•m**

Fill the circuit complying with the specifications described in the Chapter B "Maintenance".

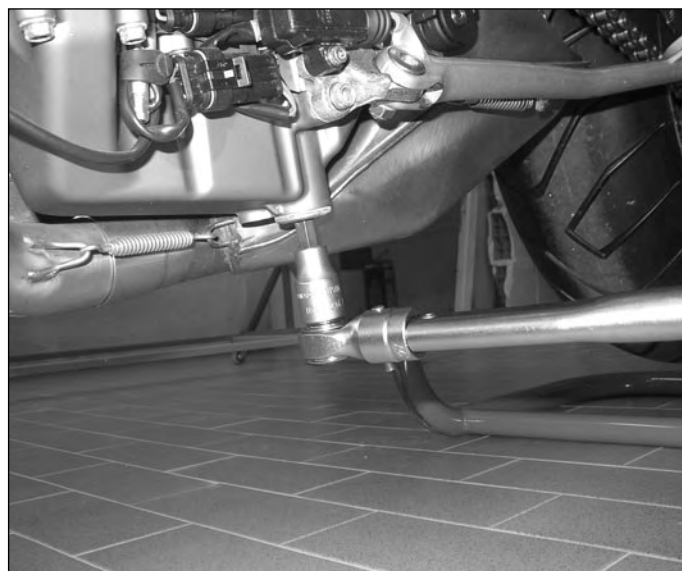



Cooling system and lubrication system

Reset the correct oil level inside the engine, verifying from the appropriate port on the right side of the engine.

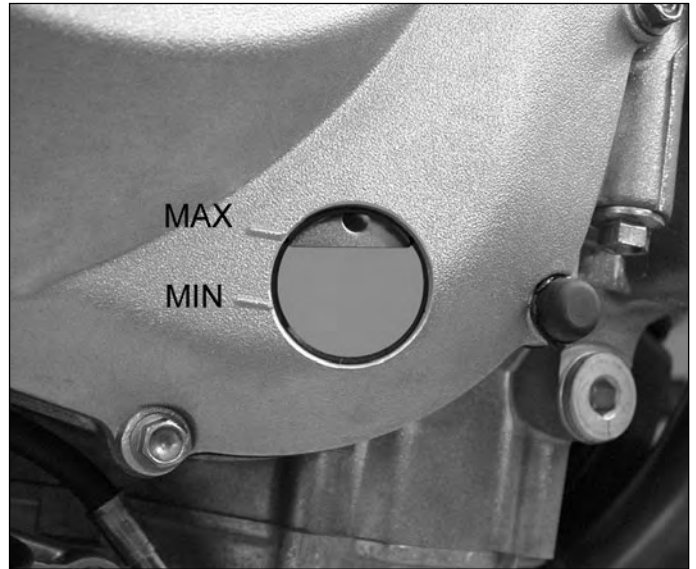

After having reset the correct level, close the filling cap (1) again.

Start the engine for some minutes.

After having shut off the engine, wait for at least 10 minutes and check the oil level. Ensure that the ground is flat and keep the motorcycle standing as much as possible.

The level must be near the "MAX" reference on the timing case as much as possible. Do not exceed this limit.

Check any oil leakages.

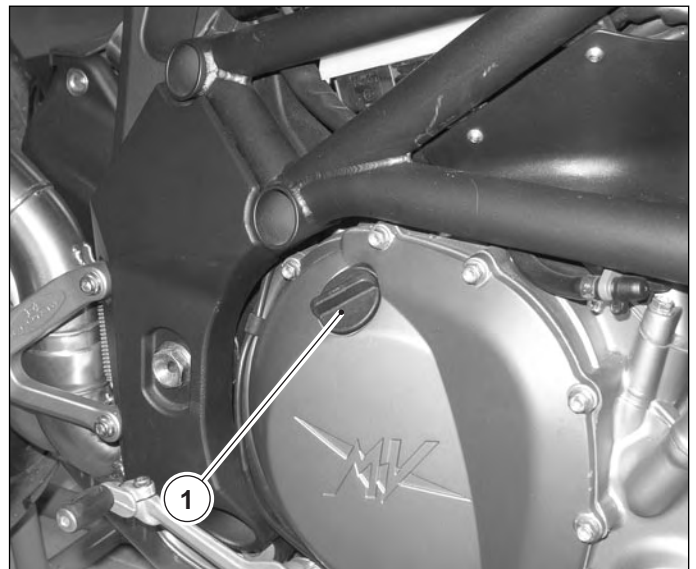

Avoid making the engine turn with the oil level lower than the minimum level; this can impair the operation of the different parts of the engine.

If the oil level, after the reset, is upper than the "MAX" reference, correct it by emptying the system.



Special tools

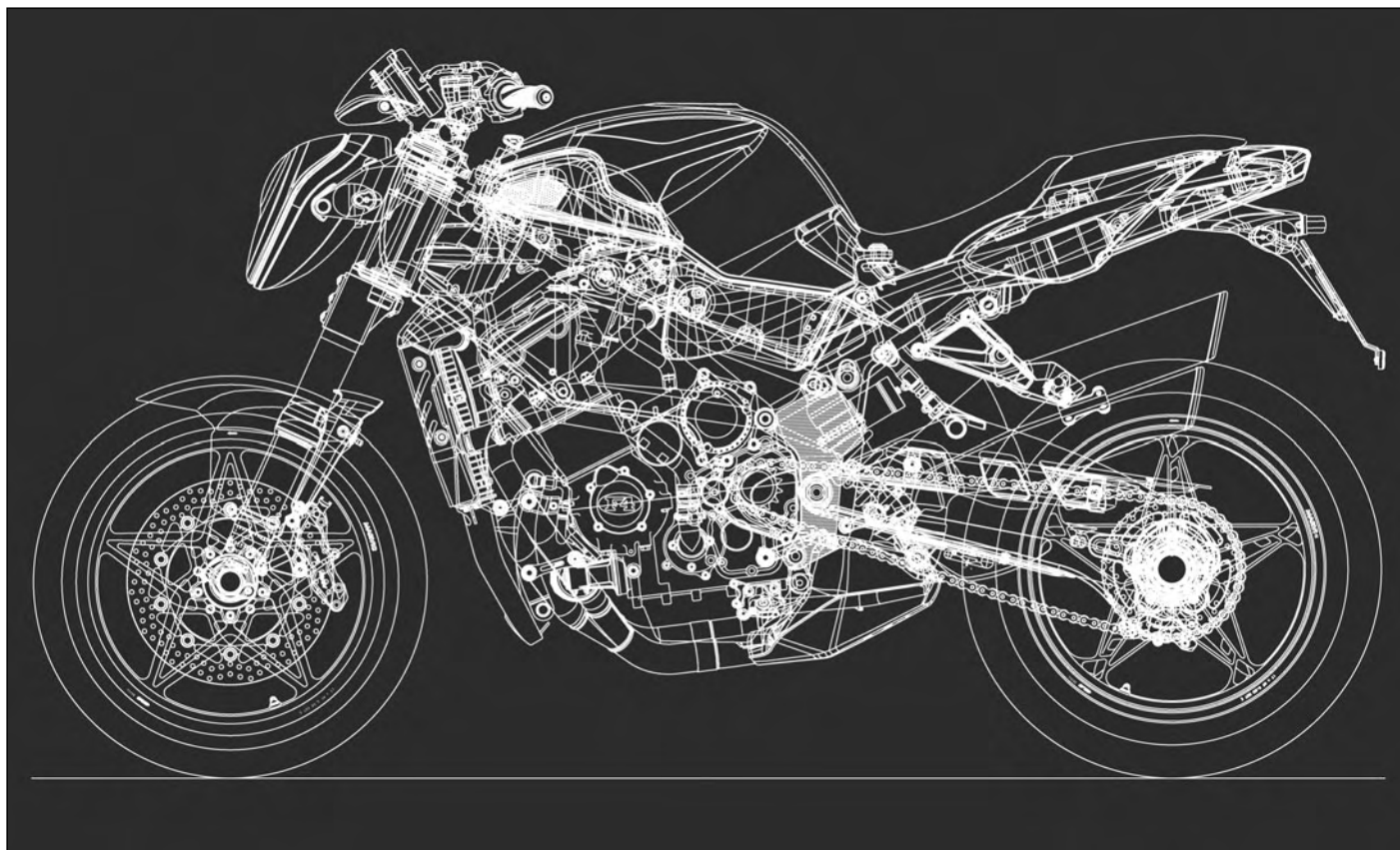

M

SECTION M

Revision 0



Special tools

Maintenance tools

The special tools shown in the following chapter are indispensable for a correct carrying out of the described maintenance operations.

To order the special tools, refer to the spare parts catalogue.



1

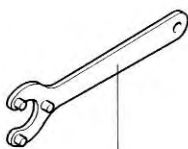

2

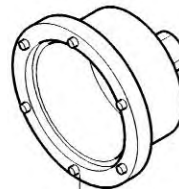

3

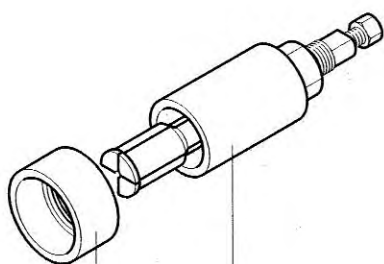

4

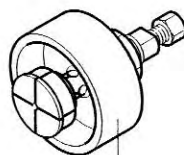

6



7

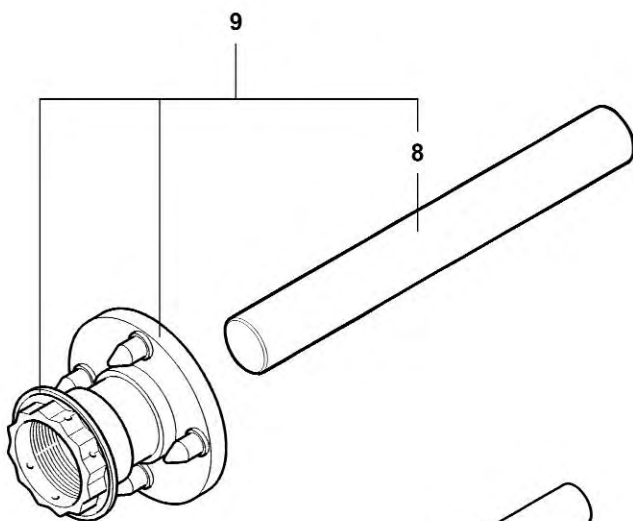

8

9

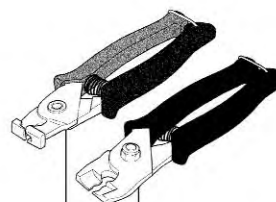

10

11

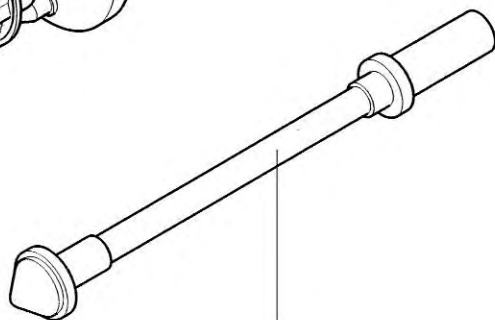

12

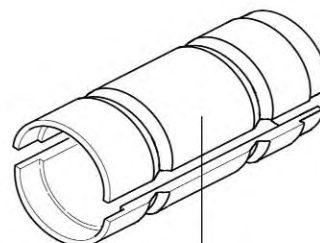

13



Special tools

N.	Code	Q.ty	Note	BRUTALE ORO	BRUTALE S	Descrizione	Description	► I FRAME I ►	► I ENGINE I ►
1	800092872	2		•	•	Chiave perno ruota anteriore	Front wheel spindle spanner		
2	800091645	1		•	•	Chiave ghiera cuscinetti di sterzo	Steering bearing pin wrench		
3	800092857	1		•	•	Chiave ghiera eccentrico sterzo	Steering cam ring nut wrench		
4	800092860	1		•	•	Estrattore cuscinetti forcellone	Fork bearings puller		
5	800092861	1		•	•	Boccola estrattore cuscinetti forcellone	Fork bearing puller bushing		
6	800092862	1		•	•	Estrattore cuscinetti ruota anteriore	Front wheel bearings puller		
7	800092863	1		•	•	Chiave per CPC	CPC spanner		
8	8000A1953	1		•	•	Perno per albero di centraggio	Pin for centering shaft		
9	800092865	1		•	•	Attr. bilanciamento ruota posteriore	Rear wheel balancing tool		
10	800095850	1		•	•	Pinza montaggio/ smontaggio fascette clic R	Pliers for clic R clamps assembly/ disassembly		
11	800098321	1		•	•	Pinza inclinata monta fascette clic R	Clic R clamp fitting pliers		
12	800092866	1		•	•	Attrezzo montaggio pacco forcellone	Fork pack assembly tool		
13	8000A1039	1		•	•	Attrezzo para-polvere e paraolio	Dust cover and oil splash guard tool		



Special tools

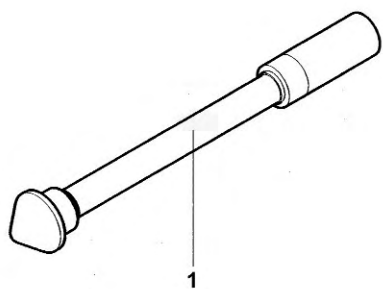

1

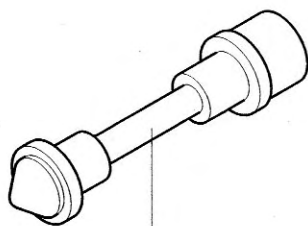

2

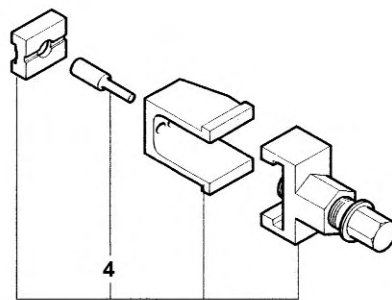

4

3

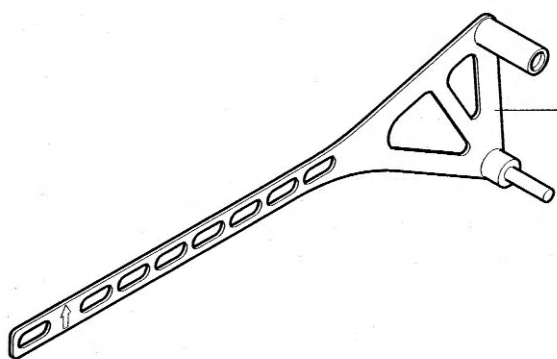

5

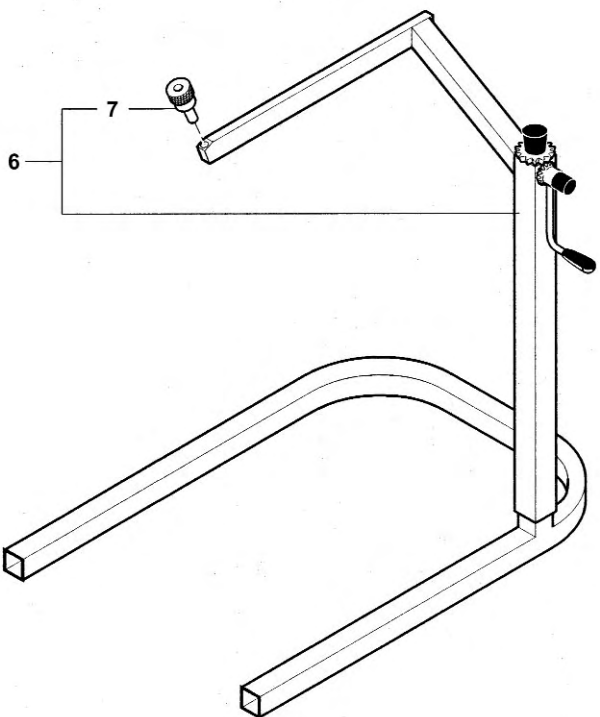

6

7

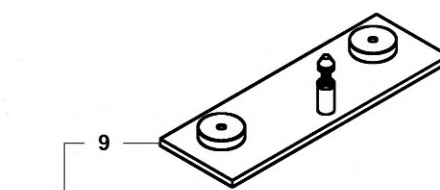

9

8

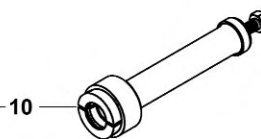

10

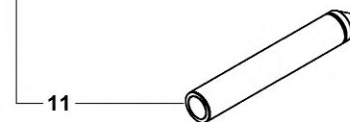

11

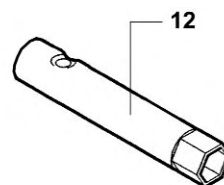

12

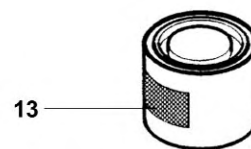

13

M



Special tools

N.	Code	Q.ty	Note	BRUTALE ORO	BRUTALE S	Descrizione	Description	► FRAME ►	► ENGINE ►
1	800092867	1		•	•	Attrezzo montaggio pacco bilanciere	Equaliser pack tool		
2	800092868	1		•	•	Attrezzo cuscinetti ruota anteriore	Front wheel bearings tool		
3	800095389	1		•	•	Attrezzo catena (passo 520:532)	Chain tool (pitch 520:532)		
4	800095390	1		•	•	Perno taglio e ribaditura (passo 520:532)	Cutting and riveting pin (pitch 520:532)		
5	800093347	1		•	•	Asta settaggio sospens. posteriore	Rear suspension setting rod		
6	800095807	1		•	•	Cavalletto anteriore	Front stand		
7	800095808	1		•	•	Perno cavalletto anteriore	Front stand pin		
8	800097887	1		•	•	Attrezzo cuscinetto perno di sterzo	Steering pin bearing tool		
9	800097888	1		•	•	Piastra di riscontro base di sterzo	Steering base plate		
10	800097889	1		•	•	Estrattore cuscinetto perno di sterzo	Steering pin bearing extractor		
11	800097890	1		•	•	Attrezzo montaggio cuscinetto perno di sterzo	Steering pin bearing assembly tool		
12	8000A1878	1		•	•	Chiave per silent-block per airbox	Airbox vibration-damper spanner		
13	800095396	1		•		Vernice "ORO MAGNESIO"	"GOLD MAGNESIUM" paint		



Special tools

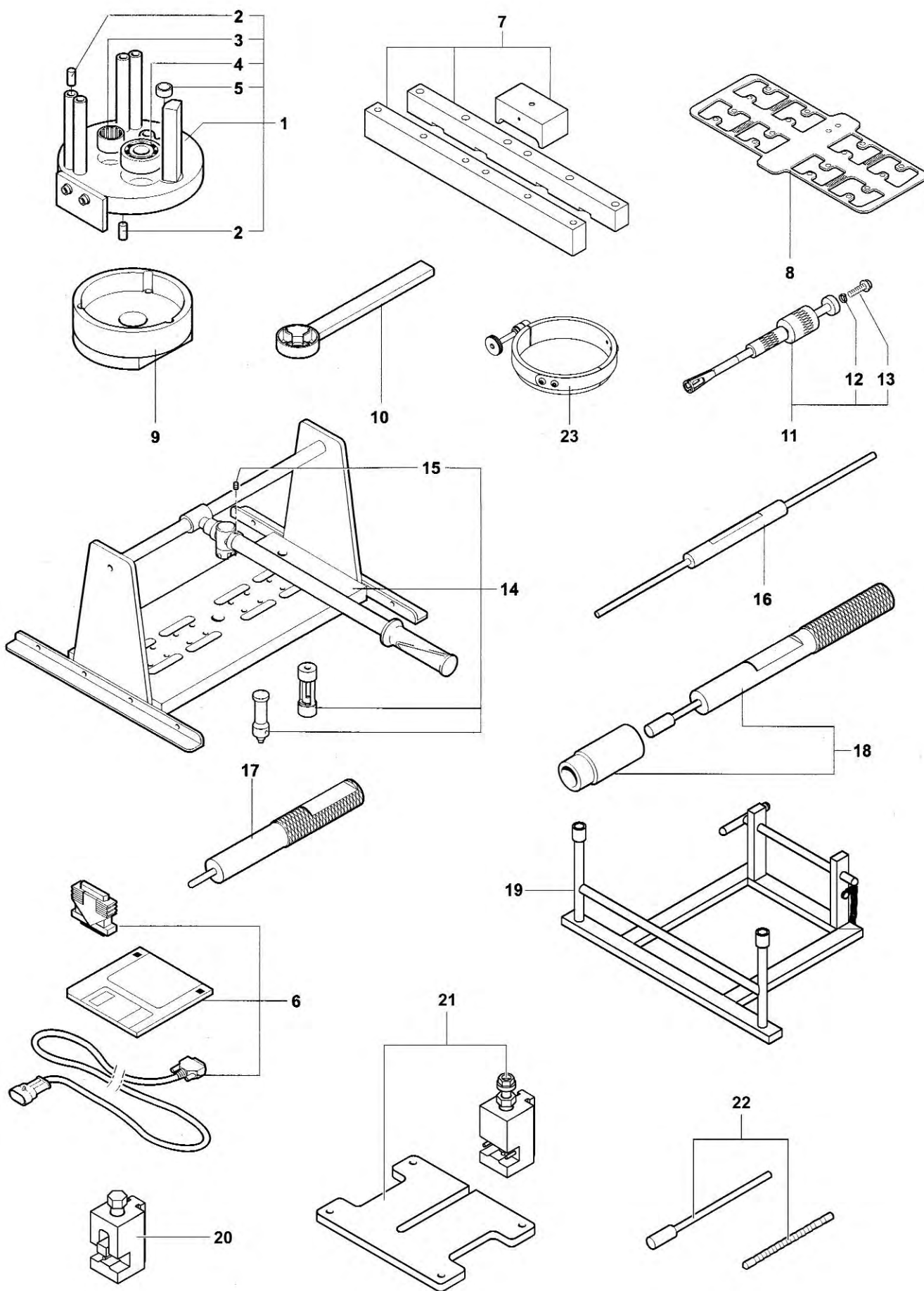

M



Special tools

N.	Code	Q.ty	Note	BRUTALE ORO	BRUTALE S	Descrizione	Description	► FRAME ►	► ENGINE ►
1	800094792	1		•	•	Attrezzo montaggio cambio	Gear change mounting tool		
2	800086119	8		•	•	Bussola di riferimento	Locating bush		
3	800081424	1		•	•	Cuscinetto	Bearing		
4	800086121	1		•	•	Cuscinetto	Bearing		
5	800087300	1		•	•	Cuscinetto	Bearing		
6	800093877	1		•	•	Software diagnostica	Diagnostics software		
7	8000A3406	1		•	•	Attrezzo misura sporgenza pistoni	Piston projection measuring tool		
8	800094797	1		•	•	Lastra sagomata copri testa	Head cover shaped plate		
9	800094795	1		•	•	Attrezzo bloccaggio rinvio albero alternatore	Alternator shaft transmission locking tool		
10	800094794	1		•	•	Attrezzo bloccaggio supporto parastrappi	Male flexible coupling support locking tool		
11	800094798	1		•	•	Attrezzo smontaggio gommini valvola	Valve rubber caps removal tool		
12	62N115538	1		•	•	Rosetta elastica	Spring washer		
13	8C0069056	3		•	•	Vite TEF M8x30	Screw M8x30		
14	800094796	1		•	•	Attrezzo montaggio/ smontaggio valvole	Valve assembly/ disassembly tool		
15	800051521	2		•	•	Vite M4x6	Screw M4x6		
16	800095429	1		•	•	Tampone controllo	Gauge pad		
17	800095581	1		•	•	Punzone montaggio tenute valvola	Valve seals mounting punch		
18	8000A2385	1		•	•	Tampone montaggio guida	Guide mounting pad		
19	800097867	1		•	•	Supporto motore	Engine support		
20	8000A2280	1		•	•	Attrezzo chiusura catena distribuz.	Timing chain mounting tool		
21	8000A2281	1		•	•	Attrezzo apertura catena distribuz.	Timing chain cutting tool		
22	8000A2625	1		•	•	Broccia per guida valvole	Broach for valve guide		
23	8000A1432	1		•	•	Attrezzo stringifasce per montaggio pistoni	Piston ring assembly tool		



Special tools

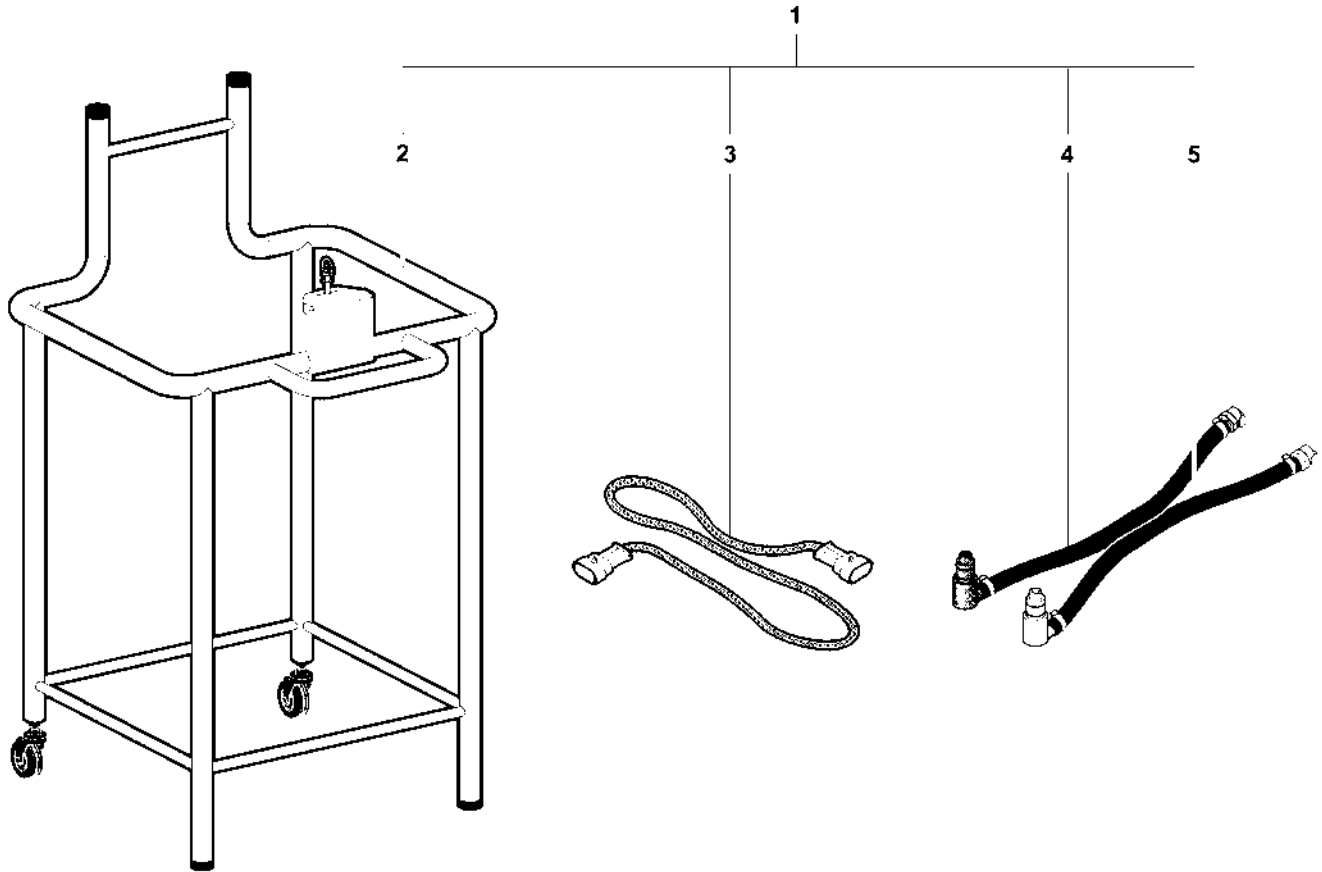

7

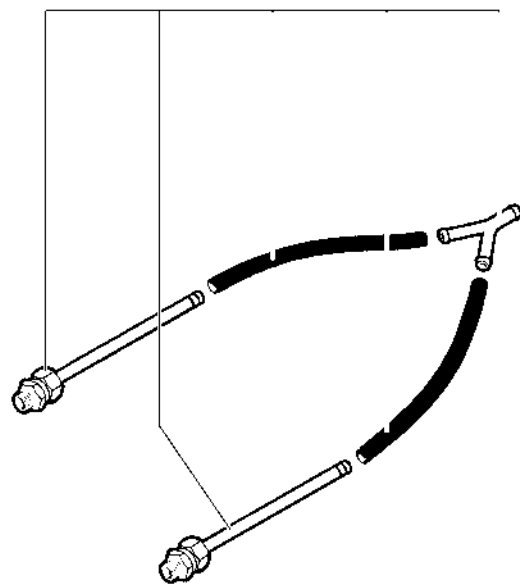
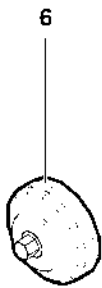

M



Special tools

N.	Code	Q.ty	Note	BRUTALE ORO	BRUTALE S	Descrizione	Description	► FRAME ►	► ENGINE ►
1	8000A1874	1		•	•	Attrezzatura per sostegno serbatoio benzina	Fuel tank support assembly		
2	8000A0965	1		•	•	Supporto per serbatoio benzina	Fuel tank support		
3	8000A1876	1		•	•	Cavo elettrico	Wire cable		
4	80A0A1875	1		•	•	Tubo mandata benzina completo	Fuel delivery pipe assembly		
5	8000A1875	1		•	•	Tubo ritorno benzina completo	Fuel return pipe assembly		
6	8000A4317	1		•	•	Attrezzo per filtro olio	Oil filter removal tool		
7	8000A4686	1		•	•	Attrezzatura per controllo CO	CO control tool assembly		



Special tools

M



Torque pressures

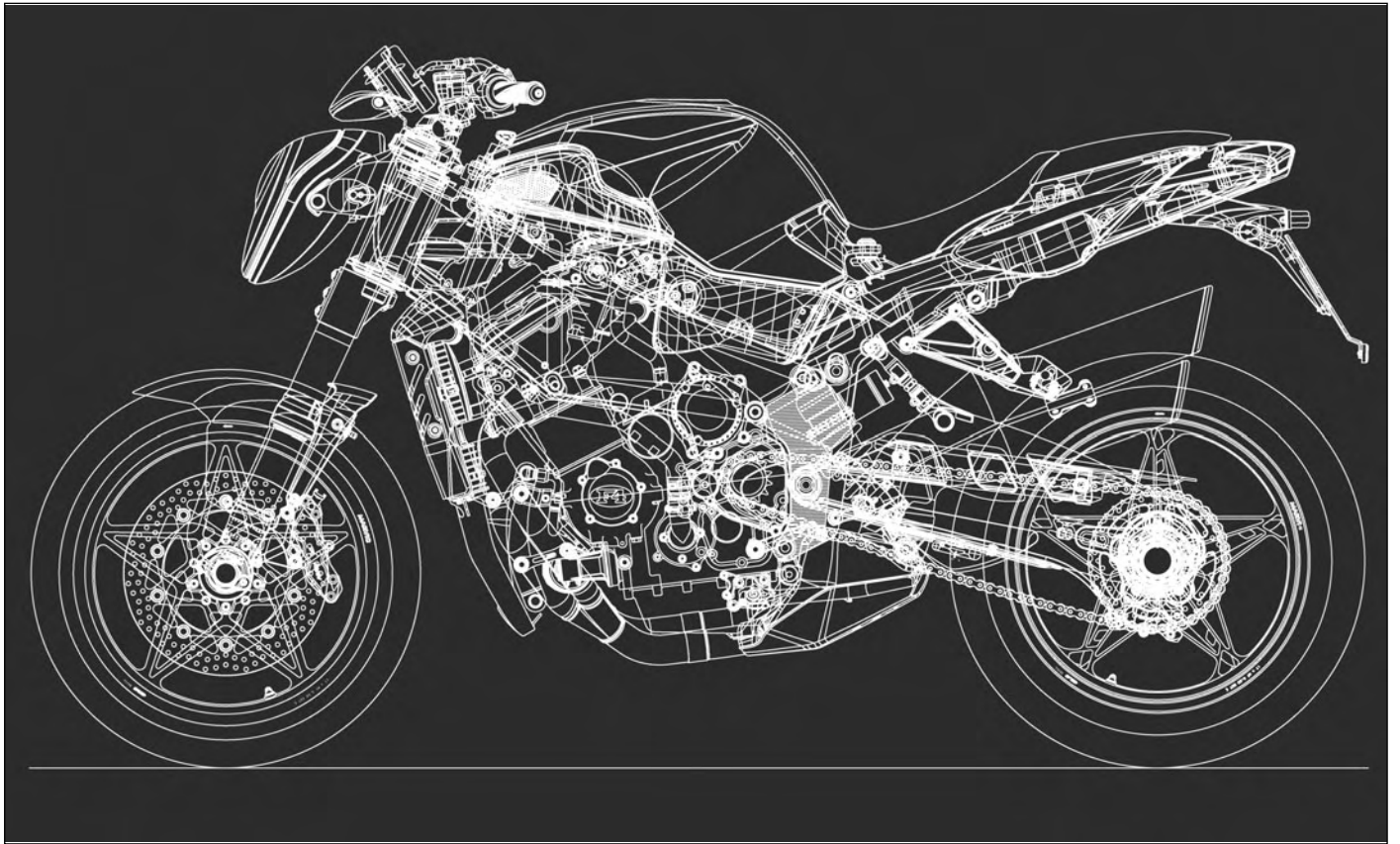

SECTION N

Revision 0

N



SUMMARY

TORQUE PRESSURES – CYCLE PARTS, EXCLUDING ENGINE - BRUTALE S

FRAMEPAGE 3

HANDLEBARS AND CONTROLSPAGE 3

FRONT SUSPENSIONPAGE 3

REAR SUSPENSIONPAGE 3

FAIRING AND MUDGUARDSPAGE 3

ELECTRICAL SYSTEMPAGE 4

FUEL FEED.....PAGE 4

WHEELS AND BRAKESPAGE 4

EXHAUST SYSTEM.....PAGE 4

INSTRUMENTATIONPAGE 4

COOLINGPAGE 4

LUBRICATIONPAGE 4

NUTS AND SCREWS NOT INDICATED IN THE TABLE:PAGE 4





Torque pressures

MV Agusta Brutale 750 S motorcycle frame torque pressures

Screws and nuts not indicated in the table:

Size and type	Description	Resistance class	Torque pressure
M5 x 0,8	Generic screws and nuts	8,8	5 + 7 Nm
M6 x 1	Generic screws and nuts	8,8	8 + 10 Nm
M8 x 1,25	Generic screws and nuts	8,8	22 + 24 Nm

List of colours and symbols:

- Torque pressure
- Key Characteristic
- Without lubrication
- With lubrication
- With thread-locking fluid

50 + 55m
With grease on first threadings only

2 Nm

3 + 4 Nm

22 + 24 Nm
With grease on first threadings only

16 + 18 Nm
With grease on first threadings only

6 + 7 Nm
With grease on first threadings only

8 + 9 Nm
With grease on first threadings only

2 Nm

16 + 18 Nm
Without grease

8 Nm
Without grease

38 + 42 Nm
With grease on first threadings only

20 + 22 Nm
With grease on first threadings only

18 + 20 Nm
Lubricates with engine oil

14 + 16 Nm
With copper (CU) grease on the first threadings only

16 + 18 Nm
Without grease

8 + 10 Nm

23 + 25 Nm

23 + 25 Nm
Loctite 243

24 + 28 Nm

70 + 75 Nm
With grease on first threadings only

55 + 60 Nm
With grease on first threadings only

6 + 8 Nm
With copper (CU) grease on the first threadings only

220 + 240 Nm
With grease on first threadings nut only
Do not apply grease on the conical part of the nut

23 + 25 Nm
Loctite 243

15 + 20 Nm
Without grease

7 + 8 Nm

75 Nm
Loctite 270

8 + 10 Nm
Loctite 243

95 + 100 Nm
With grease on threadings and on the contact part

En apoyo + 10°
With grease on first threadings only

18 + 20 Nm
With grease on first threadings only

5 + 7 Nm
Loctite 243

24 Nm
Lubricate with engine oil

In contact + 45°

6 + 6.5 Nm max

3 Nm
Loctite 577

5 Nm

18 + 20 Nm
Loctite 270

30 + 35 Nm
Loctite 243

In contact + 90°



Torque pressures

MV Agusta Brutale 750 S motorcycle frame torque pressures

List of colours and symbols:

- Torque pressure
- Key Characteristic
- Without lubrication
- With lubrication
- With thread-locking fluid

For screws and nuts not indicated in the diagram:

Size and type	Description	Resistance class	Torque pressure
M5 x 0,8	Generic screws and nuts	8,8	5 - 7 Nm
M6 x 1	Generic screws and nuts	8,8	8 - 10 Nm
M8 x 1,25	Generic screws and nuts	8,8	22 - 24 Nm

Screw by hand



Diagnostics

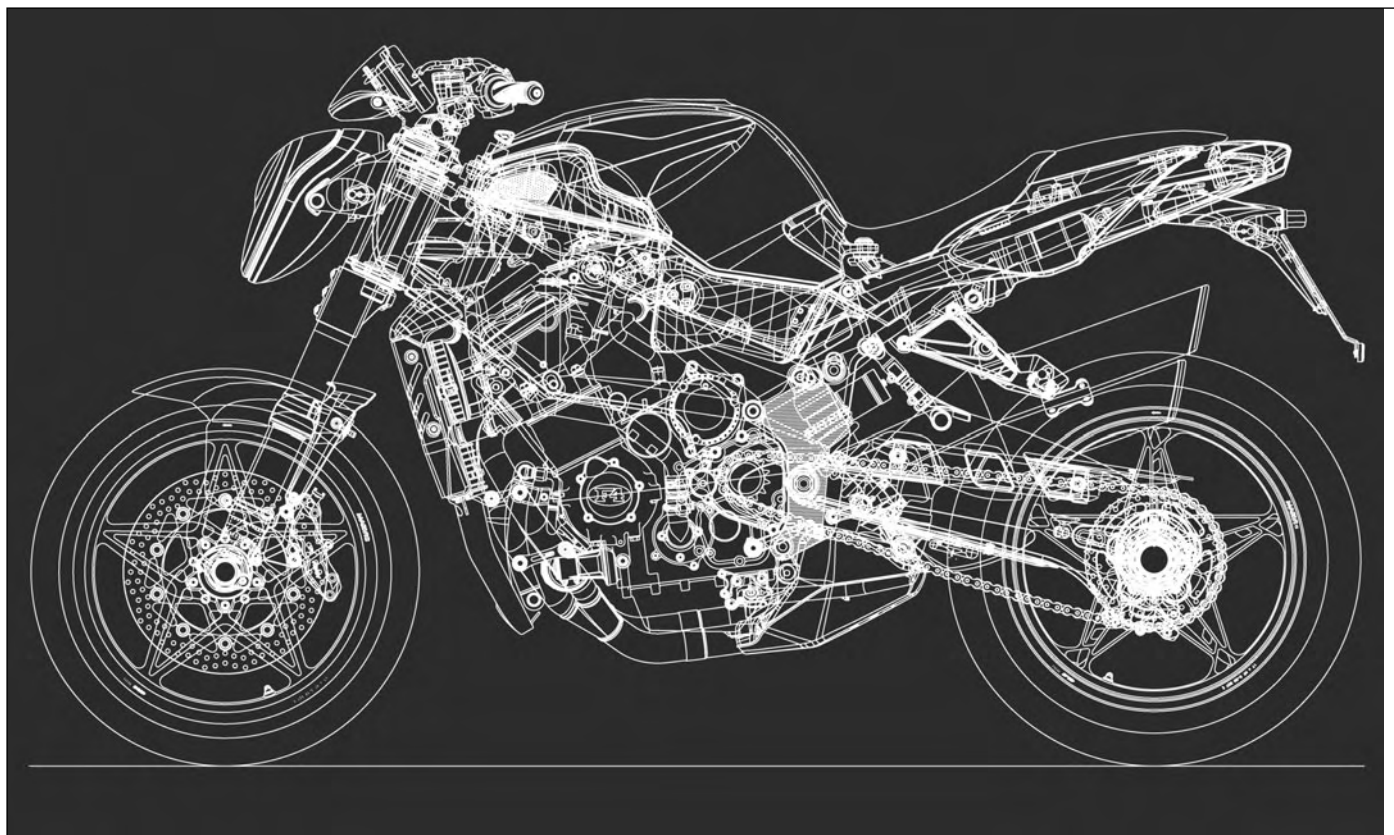

SECTION **O**

Revision 0

O



Diagnosics

DIAGNOSTICS

ELECTRICAL PARTS

CHARGING SYSTEM

Battery warning light on

Defective alternator	Substitute
Defective alternator connection	Check
Defective battery	Substitute
Recharging fuse (40A) burnt out	Substitute
Defective recharging fuse connection	Deoxidise/replace
Oxidised battery connections	Deoxidise/replace

SERVICES ELECTRICAL SYSTEM 12V

No function is operative

Defective ignition switch	Substitute
Defective ignition switch connection	Deoxidise/replace
Defective general relay	Substitute
Defective general relay connection	Deoxidise/replace

STARTER SYSTEM

Starter motor does not function

E5 fuse burnt out	Substitute
Defective E5 fuse connection	Deoxidise/replace
Defective neutral gear sensor	Substitute
Defective clutch pump switch	Substitute
Defective starter motor	Substitute
Defective starter button	Substitute
Defective electrical connection – right handlebar control unit	Deoxidise/replace
Defective ignition switch	Substitute
Defective power cable connection	Deoxidise/replace

COOLING SYSTEM

Electric fan does not function

A1 fuse burnt out	Substitute
Defective A1 fuse connection	Deoxidise/replace
Defective fan relay	Substitute
Defective thermo-switch	Substitute
Defective thermo-switch connection	Deoxidise/replace
Defective fan	Deoxidise/replace

LIGHTING/INDICATOR SYSTEM

Front/rear sidelights do not function

C3 fuse burnt out	Substitute
Defective C3 fuse connection	Deoxidise/replace
Defective ignition switch	Substitute
Defective ignition switch connection	Deoxidise/replace
Burnt out bulbs	Substitute
Defective bulb connections	Deoxidise/replace
Defective light switch	Substitute
Defective light switch connection	Deoxidise/replace

Main beam/dipped beam lights do not function

B2 fuse burnt out	Substitute
Defective B2 fuse connection	Deoxidise/replace
Burnt out bulbs	Substitute
Defective bulb connections	Deoxidise/replace
Defective light switch	Substitute
Defective light switch connection	Deoxidise/replace
Defective main beam light relay	Substitute
Defective main beam light relay connection	Deoxidise/replace

Rear stop light does not function

D4 fuse burnt out	Substitute
Defective D4 fuse connection	Deoxidise/replace
Burnt out bulb	Substitute
Defective bulb connections	Deoxidise/replace
Defective front brake lever switch	Substitute
Defective front brake lever switch connection	Deoxidise/replace
Defective rear brake lever switch	Substitute
Defective rear brake lever switch connection	Deoxidise/replace

Rear stop light remains on

Front brake lever switch blocked	Substitute/repair
Rear brake lever switch blocked	Substitute/repair



Diagnostics

Horn does not function	D4 fuse burnt out	Substitute
	Defective D4 fuse connection	Deoxidise/replace
	Defective klaxon	Substitute
Direction indicators do not function	D4 fuse burnt out	Substitute
	Defective D4 fuse connection	Deoxidise/replace
	Defective intermittency	Substitute
	Defective intermittency connection	Deoxidise/replace
	Bulbs burnt out	Substitute
	Defective bulb connection	Deoxidise/replace
	Defective direction indicator switch	Substitute
	Defective indicator switch connection	Deoxidise/replace
Direction indicator remains on	Bulb of the other indicator, same side, is burnt out	Substitute
	The connection of the other indicator is defective	Deoxidise/replace
INSTRUMENT PANEL SYSTEM		
Instrument panel does not function	G7 fuse burnt out	Substitute
	Defective G7 fuse connection	Deoxidise/replace
Instrument panel does not illuminate	G7 fuse burnt out	Substitute
	Defective G7 fuse connection	Deoxidise/replace
	C3 fuse burnt out	Substitute
	Defective C3 fuse connection	Deoxidise/replace
	Defective instrument panel	Substitute
	Internal bulb burnt out	Substitute
	Defective bulb connection	Deoxidise/replace
	Defective injection CPU IAW 1.6M	Substitute
	Defective instrument panel	Substitute
	Defective instrument panel connection	Deoxidise/replace
	Defective CPU connection	Deoxidise/replace
Speedometer does not work	Defective speed sensor	Substitute
	Defective speed sensor connection	Deoxidise/replace
	C3 fuse burnt out	Substitute
	Defective C3 fuse connection	Deoxidise/replace
	Defective instrument panel	Substitute
	Defective instrument panel connection	Deoxidise/replace
Water temperature indicator does not function	Defective temperature sensor	Substitute
	Defective temperature indicator connection	Deoxidise/replace
	Defective instrument panel	Substitute
	Defective instrument panel connection	Deoxidise/replace
The oil warning light does not function	Defective oil pressure sensor	Substitute
	Defective oil pressure sensor connection	Deoxidise/replace
	Defective instrument panel	Substitute
	Defective instrument panel connection	Deoxidise/replace
Neutral gear warning light does not function	Defective neutral gear sensor	Substitute
	Defective neutral gear sensor connection	Deoxidise/replace
Battery warning light does not function	Defective alternator connection	Deoxidise/replace
	Defective instrument panel	Substitute
	Defective instrument panel connection	Deoxidise/replace
Side stand warning light does not function	Defective side stand switch	Substitute
	Defective side stand switch connection	Deoxidise/replace
	Defective instrument panel	Substitute
	Defective instrument panel connection	Deoxidise/replace
Reserve fuel warning light does not function	Defective fuel level sensor	Substitute
	Defective fuel level sensor connection	Deoxidise/replace
	Defective instrument panel	Substitute
	Defective instrument panel connection	Deoxidise/replace
	C3 fuse burnt out	Substitute
	Defective C3 fuse connection	Deoxidise/replace
Direction indicator warning light does not function	Defective intermittency	Substitute
	Defective intermittency connection	Deoxidise/replace
	Defective instrument panel	Substitute
	Defective instrument panel connection	Deoxidise/replace
Sidelight warning light does not function	Defective instrument panel	Substitute
	Defective instrument panel connection	Deoxidise/replace
Main beam warning light does not function	Defective instrument panel	Substitute
	Defective instrument panel connection	Deoxidise/replace



Diagnostics

INJECTION IGNITION IAW 1.6M

Pressure sensor/air temperature signal error

Defective sensor	Substitute
Defective sensor connection	Deoxidise/replace
Defective potentiometer	Substitute
Defective potentiometer connection	Deoxidise/replace
Defective engine temperature sensor	Substitute
Defective engine temperature sensor connection	Deoxidise/replace

Butterfly valve potentiometer signal error

Engine temperature sensor signal error

FUEL INJECTION SYSTEM

Injector does not inject fuel

C6 fuse burnt out	Substitute
Defective C6 fuse connection	Deoxidise/replace
E5 fuse burnt out	Substitute
Defective E5 fuse connection	Deoxidise/replace
H8 fuse burnt out	Substitute
Defective H8 fuse connection	Deoxidise/replace
Defective power relay	Substitute
Defective power relay connection	Deoxidise/replace
Defective latch relay	Substitute
Defective latch relay connection	Deoxidise/replace
Defective injector	Substitute
Defective injector connection	Deoxidise/replace
Defective injection CPU IAW 1.6M	Substitute
Defective side stand switch	Substitute
Defective safety CPU	Substitute
Defective engine pick-up	Substitute
Pick-up light/timing wheel not correct	Reset
Defective fuel pump	Substitute

IGNITION SYSTEM

Spark plug does not function

F6 fuse burnt out	Substitute
Defective F6 fuse connection	Deoxidise/replace
E5 fuse burnt out	Substitute
Defective E5 fuse connection	Deoxidise/replace
G7 fuse burnt out	Substitute
Defective E5 fuse connection	Deoxidise/replace
Defective power relay	Substitute
Defective power relay connection	Deoxidise/replace
Defective latch relay	Substitute
Defective latch relay connection	Deoxidise/replace
Defective coil	Substitute
Defective spark plug leads	Substitute
Defective injection CPU IAW 1.6M	Substitute
Defective safety switch	Substitute
Defective spark plug	Substitute
Defective engine earth connection	Reset
Defective side stand switch	Substitute
Defective safety CPU	Substitute
Defective engine pick-up	Substitute
Pick-up light/timing wheel not correct	Reset

FRAME

STEERING

Steering is stiff

Damaged steering bearings	Substitute
Steering bearings over-tightened	Adjust
Bent steering pin	Substitute
Steering shock absorbers brake too much	Adjust
Damaged shock absorber joint	Substitute
Low tyre pressure.	Adjust
Bent forks	Substitute
Bent frame	Substitute
Bent rear fork	Substitute
Damaged shock absorber steering joint	Substitute
Damaged steering bearings	Substitute
Bent wheel spindle	Substitute
Damaged rear fork bearings	Substitute

The motorcycle does not proceed in a straight line



Diagnosics

FRONT WHEEL

Front wheel oscillates/vibrates	Bent wheel rim	Substitute
	Wheel not balanced	Balance the wheel
	Defective tyre	Substitute
	Non-recommended tyre	Substitute
	Damaged wheel bearings	Substitute
	Wheel fixing screws not tightened	Tighten
Front wheel does not turn easily	Wheel spindle fixing ring not tightened	Tighten
	Damaged bearings	Substitute
	Bent wheel spindle	Substitute
	Brake pads excessively brush against the discs /see brakes)	Check
	Deformed brake discs	Substitute
	Wheel spindle ring excessively tightened	Tighten to the correct torque pressure

FRONT SUSPENSION

Front suspension too spongy	Deteriorated fork oil	Substitute
	Insufficient spring loading	Adjust
	Insufficient hydraulic braking under compression	Adjust
	Low fork oil level	Top-up
	Low tyre pressure	Adjust
	Damaged forks	Repair
Front suspension too rigid	Excessive spring pre-loading	Adjust
	Excessive hydraulic braking under compression	Adjust
	Fork oil level too high	Adjust
	High tyre pressure	Adjust

REAR WHEEL

Rear wheel oscillates/vibrates	Bent wheel rim	Substitute
	Wheel not balanced	Balance the wheel
	Defective tyre	Substitute
	Non-recommended tyre	Substitute
	Damaged wheel bearings	Tighten
	Fixing nut not tightened	Tighten
Rear wheel does not turn easily	Suspension screws not tightened	Tighten
	Damaged suspension bearings	Substitute
	Damaged bearings	Substitute
	Wheel hub circlip out of its seat	Check
	Brake pads excessively brush against the disc	Check
	Bent brake disc	Substitute
Damaged transmission chain	Substitute	

REAR SUSPENSION

Rear suspension too spongy	Insufficient spring pre-loading	Adjust
	Insufficient hydraulic braking under compression	Adjust
	Insufficient hydraulic braking in extension	Adjust
	Low tyre pressure	Adjust
Rear suspension too rigid	Damaged shock absorber	Substitute
	Excessive spring pre-loading	Adjust
	Excessive hydraulic braking under compression	Adjust
	Excessive hydraulic braking in extension	Adjust
	High tyre pressure	Adjust
	Damaged fork bearings	Substitute
	Damaged compensator suspension bearings	Substitute
	Damaged shock absorber joint	Substitute
Damaged connecting rod suspension joints	Repair	
Bent fork pin	Substitute	

BRAKES

Brake lever and pedal movement too spongy	Air bubbles in the braking system	Bleed
	Leakages in the braking system	Repair
	Damaged pincer seals	Substitute
	Damaged pump seals	Substitute
	Pincer pistons do not operate smoothly	Check
	Low brake fluid level	Top-up
Brake lever and pedal movement too hard	Deformed brake discs	Substitute
	Bent brake lever or pedal	Substitute



Diagnostics

Insufficient braking power

Discs dirty	Clean
Air bubbles in the braking system	Bleed
Leakages in the braking system	Repair
Damaged pincer seals	Substitute
Damaged pump seals	Substitute
Pincer pistons do not operate smoothly	Check
Low brake fluid level	Top-up
Deformed brake discs	Substitute

Brake pads brush against the discs

Damaged pad springs	Substitute
Deformed brake discs	Substitute
Pincer pistons do not operate smoothly	Check
Brake fluid level too high	Adjust
Brake pads worn past the limit	Substitute

EXHAUST SYSTEM

Excessive noise from the silencers

Damaged exhaust tube	Substitute
Slack tube fixings	Tighten

Low engine performance

Damaged exhaust tube	Substitute
Slack tube fixings	Tighten

COOLING SYSTEM

Engine temperature too high

Low engine coolant level	Top-up
Defective cooling fan	Substitute
Defective coolant expansion chamber cap	Substitute
Defective fan thermal switch	Substitute
Defective temperature sensor	Substitute
Thermostat is blocked in the closed position	Substitute
Radiator finning bent or blocked	Repair/clean
Encrusted radiator	Clean
Damaged water pump	Substitute
Defective injection/ignition system	Check
Non-recommended fuel	Substitute
Defective engine cooling system	Check
Non-recommended thermal grade of the spark plug	Substitute
Accumulation of carbon residues on the cylinder head/pistons	Clean
Thermostat blocked in the open position	Substitute

Engine temperature too low

Thermostat blocked in the open position	Substitute
---	------------



Analytical index

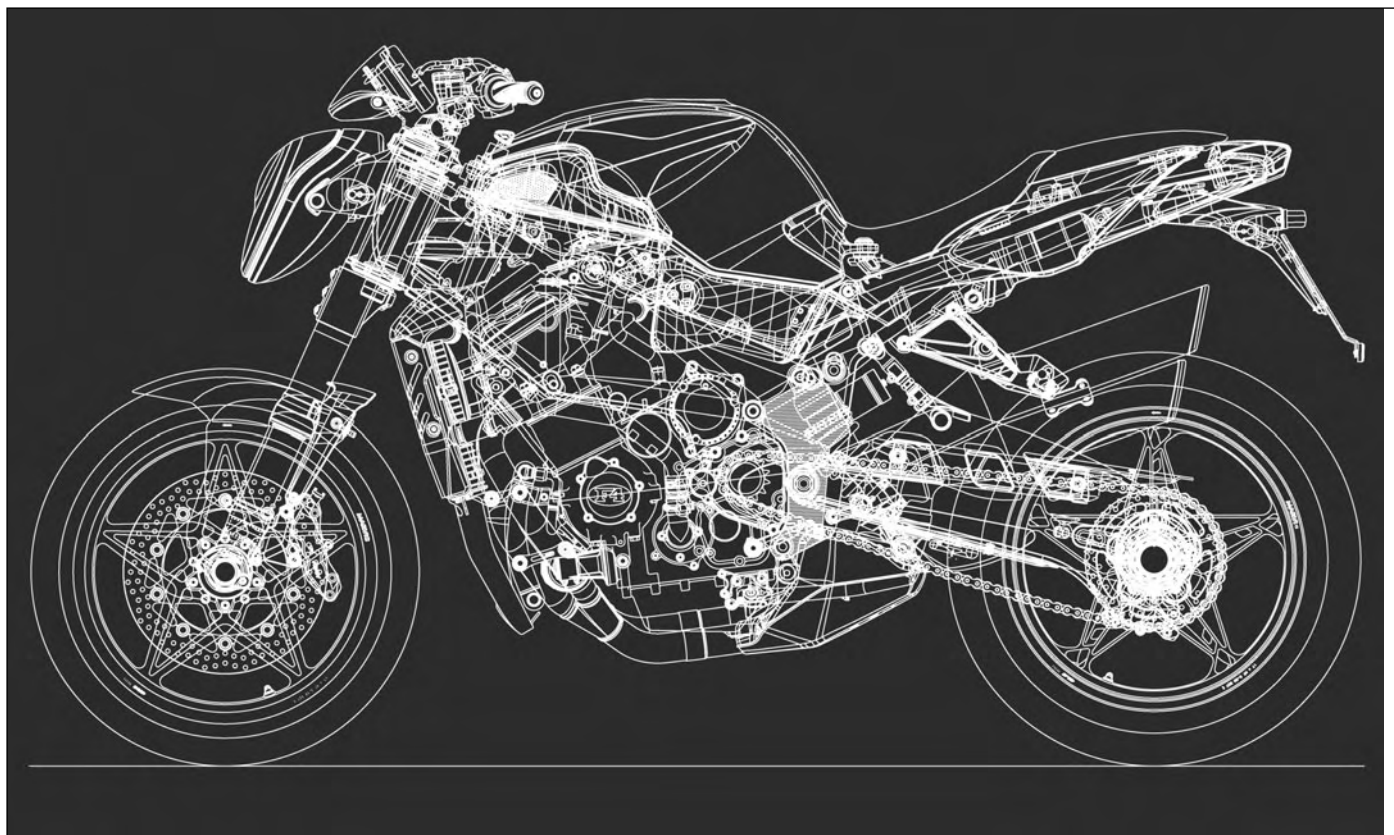

SECTION P
Revision 0

P



Analytical index

ANALYTICAL INDEX – BRUTALE WORKSHOP MANUAL

Chapter A - General Description

Glossary and symbols	A-4
How to consult this manual	A-3
Index	A-8
Operative technical specifications	A-9
Purpose of the manual	A-3
Right hand and left hand standard	A-5
Safety	A-6
Warning	A-8

Chapter B - Maintenance

Accelerator control	B-65
Air filter	B-57
Battery	B-77
Brake pads	B-65
Brake/clutch/gearchange commands check	B-63
Brakes and clutch	B-60
Components in carbon fibre (f4 brutale oro)	B-6
Electric cooling fan	B-21
Electrical system	B-77
Engine coolant	B-19
Engine oil and oil filter	B-11
Front fork	B-76
Front headlamp	B-92
Front wheel bearings	B-72
Fuel filters	B-34
Fuel pump assembly	B-44
Fuel tubes assembly	B-47
Fuel union tubes	B-47
Instruments and warning lights	B-80
Lights	B-85
Locks	B-67
Magnesium components (F4 brutale oro)	B-7
Maintenance and tuning operations	B-11
Oscillating arm bearings	B-74
Periodical maintenance schedule	B-9
Rear shock absorber	B-74

Rear wheel hub	B-74
Screws and nuts	B-76
Slide stand	B-75
Spark plugs	B-33
Steering	B-69
Technical data	B-3
Technical information	B-3
Throttle body adjustment and tuning	B-50
Transmission chain	B-69
Tube band fasteners	B-76
Tyres	B-72
Valve mechanism adjustment	B-22
Wheels	B-73

Chapter C - Bodywork

Air filter compartment removal	C-16
Air filter compartment	C-15
Disassembling front headlamp	C-4
Disassembling fuel tank side panels	C-9
Disassembling handlebar	C-6
Disassembling headlight support	C-7
Disassembling instrumentation panel	C-5
Disassembling under tale unit	C-25
Fairing assembly	C-3
Fuel tank removal	C-10
Fuel tank	C-8
Tail unit removal	C-21
Tail unit	C-20
Under-tail assembly	C-24

Chapter D - Injection system

Actuators	D-15
Components	D-9
Diagnostics system	D-16
Engine pick-up	D-14
Fuel pump control system	D-7
Injection arrest control	D-4
Injection system - electrical diagram	D-17
Injection system technical characteristics	D-3



Analytical index

Injection time (injection volume)	D-3
Injection time compensation	D-4
Injection-ignition system	D-3
Motor control - position of the parts	D-6
Sensors	D-11
Timing wheel gap	D-14

Starter motor check	E-33
Starter motor removal	E-32
Starter relay activation	E-42
Starter system	E-23
Switches	E-46

Chapter E - Electrical system

Battery assembly	E-7
Battery efficiency check	E- 20
Battery	E-7
Charging system	E-12
Connectors	E-3
Cooling fan system	E-44
Couplings	E-3
Cpu	E-22
Electrical diagram	E-5
Fuel level warning light check switch	E-41
Function diagram	E-22
Fuses	E-3
Fuses	E-32
Gearchange position switch	E-36
Ignition/side stand safety system parts check	E-35
Initial battery charge	E-7
Instrument panel water sensor	E-42
Instrumentation	E-40
Key ignition switch	E-42
Klaxon	E-45
Left direction indicator	E-43
Oil pressure sensor	E-41
Parts list	E-6
Right direction indicator	E-43
Rpm indicator	E-43
Semiconductor parts	E-4
Slide stand switch	E-36
Spark plugs	E-37
Speed sensor	E-43
Starter motor assembly	E-33

Chapter F - Suspension and wheels

Front fork overhaul	F-11
Front fork	F-10
Front wheel removal	F-4
Front wheel	F-3
Mono-arm fork removal and overhaul	F-36
Motorcycle set-up adjustment	F-58
Rear suspension and fork	F-29
Rear wheel hub	F-44
Rear wheel removal	F-45
Steering assembly	F-23
Steering assembly overhaul	F-24
Wheel balance check	F-62

Chapter G - Frame

Assembly frame to the motorcycle	G-18
Engine removal	G-25
Frame control reference measurements	G-16
Frame disassembly	G-12
Frame removal preliminary operations	G-3
Rear sub-frame removal	G-22
Throttle body removal	G-7





Analytical index

Chapter H - Brakes

Clutch lever removal	H-13
Front brake calipers substitution	H-10
Front brake disc removal	H-15
Front brake discs	H-14
Front brake lever removal	H-12
Front brake pads substitution	H-4
Front brake pump removal	H-11
Front brake system	H-3
Front mudguard removal	H-4
Rear brake caliper substitution	H-24
Rear brake disc removal	H-27
Rear brake disc	H-26
Rear brake pads substitution	H-19
Rear brake system	H-18
Substitution and bleeding of the front brake fluid	H- 6
Substitution and bleeding of the rear brake fluid	H- 22

Chapter L - Cooling system

Assembling water radiator	L-22
Checking cooling fan starter	L-13
Complete cooling system assembly and lubrication system	L-3
Coolant temperature sensor	L-15
Cooling system leakage check	L-4
Disassembling electric fan	L-12
Disassembling water radiator	L-8
Engine coolant extraction	L-5
Expansion tank cap check	L-4
Expansion tank removal	L-5
Reassembling expansion tank	L-20
Reassembling oil radiator	L-31
Reassembling thermostat valve	L-18
Removing oil radiator	L-27
Removing thermostat valve	L-16

Chapter M - Special tools

Maintenance tools	M-2
-------------------	-----

Chapter N - Torque pressures

Torque pressures – cycle parts, excluding engine - BRUTALE ORO	
Cooling	N-7
Electrical system	N-6
Exhaust system	N-7
Fairing and mudguards	N-6
Frame	N-5
Front suspension	N-5
Fuel feed	N-6
Handlebars and controls	N-5
Instrumentation	N-7
Lubrication	N-7
Nuts and screws not indicated in the table:	N-7
Rear suspension	N-6
Wheels and brakes	N-6

Torque pressures – cycle parts, excluding engine - BRUTALE S

Cooling	N-4
Electrical system	N-4
Exhaust system	N-4
Fairing and mudguards	N-3
Frame	N-3
Front suspension	N-3
Fuel feed	N-4
Handlebars and controls	N-3
Instrumentation	N-4
Lubrication	N-4
Nuts and screws not indicated in the table:	N-4
Rear suspension	N-3
Wheels and brakes	N-4

Chapter P - Analytical index

Analytical index - BRUTALE workshop manual	P-2
--	-----