



Motorcycle Art



MV AGUSTA F4 BRUTALE 910 S

Manuale dell'utente - **U**ser's manual

910
-BRUTALE

MV AGUSTA

**910
BRUTALE**



Manuale dell'utente
Versione Italiana

Gentile cliente,

La ringraziamo per la fiducia accordataci e ci congratuliamo con Lei per la Sua nuova F4 Brutale 910 S. MV Agusta, grazie alla passione e all'impegno dei suoi tecnici, si ripropone agli appassionati con un prodotto caratterizzato da una inedita veste estetica accostata ad una raffinata ciclistica: elementi che hanno contraddistinto tutte le creazioni del marchio MV Agusta nell'arco della sua gloriosa storia.

Il risultato è una moto esclusiva che, per le sue caratteristiche estetiche e funzionali e le innumerevoli innovazioni tecniche, si pone al di sopra dei prodotti di più alto profilo che il mercato motociclistico possa oggi offrire.

Le soluzioni adottate conferiscono, infatti, ad F4 Brutale 910 S quell'inconfondibile carattere che la lega agli altri modelli della famiglia MV Agusta, consolidando una filosofia progettuale che privilegia la costante ricerca, l'innovazione tecnologica e l'amore per il dettaglio dando la possibilità, a chi vive la propria passione motociclistica in piena libertà, di possedere un oggetto unico al mondo che si pone con prepotenza come riferimento di livello mondiale.

Se desiderasse ulteriori informazioni, non esiti a contattare il Servizio Assistenza Clienti MV Agusta.

Buon divertimento!

*Claudio Castiglioni
Presidente
MV Agusta*



INDICE GENERALE

<i>cap.</i>	<i>Descrizione argomenti</i>	<i>pag.</i>	<i>cap.</i>	<i>Descrizione argomenti</i>	<i>pag.</i>
1	INFORMAZIONI GENERALI	5	4	USO	31
1.1.	Scopo del manuale	5	4.1.	Uso della motocicletta	31
1.2.	Simbologia	6	4.2.	Rodaggio	32
1.3.	Contenuto del CD-Rom	7	4.3.	Avviamento motore	34
1.4.	Dati di identificazione	8	4.4.	Selezione e modifica funzioni display	36
2	INFORMAZIONI SULLA SICUREZZA	11	4.4.1.	Selezione funzioni display	37
2.1.	Uso consentito del veicolo	11	4.4.2.	Regolazione delle unità di misura	38
2.2.	Manutenzione	11	4.4.3.	Azzeramento delle funzioni contachilometri parziali	41
2.3.	Accessori e modifiche	12	4.4.4.	Regolazione della funzione orologio	44
2.4.	Carico veicolo	12	4.5.	Rifornimento carburante	46
3	COMANDI E STRUMENTI	14	4.6.	Accesso al vano portaoggetti	48
3.1.	Posizione comandi e strumenti	14	4.7.	Sosta della motocicletta	50
3.2.	Cavalletto laterale	16	5	REGOLAZIONI	52
3.3.	Comandi al manubrio lato sinistro	17	5.1.	Elenco regolazioni	52
3.4.	Comandi al manubrio lato destro	19	5.2.	Tabella delle regolazioni	55
3.5.	Interruttore accensione e bloccasterzo	22	5.3.	Regolazione leva freno anteriore	56
3.6.	Comando cambio	26	5.4.	Regolazione leva frizione	56
3.7.	Strumentazione e spie	27	5.5.	Regolazione specchietti retrovisori	57
3.7.1.	Spie luminose di indicazione	28	5.6.	Regolazione sospensione anteriore	58
3.7.2.	Display multifunzione	29	5.6.1.	Precarico molla	59
3.8.	Tabella lubrificanti e liquidi	30			



INDICE GENERALE

<i>cap.</i>	<i>Descrizione argomenti</i>	<i>pag.</i>
5.6.2.	Dispositivo idraulico di frenatura in estensione (sospensione anteriore)	59
5.6.3.	Dispositivo idraulico di frenatura in compressione (sospensione anteriore)	60
5.7.	Regolazione sospensione posteriore	61
5.7.1.	Dispositivo idraulico di frenatura in estensione (sospensione posteriore)	62
5.7.2.	Dispositivo idraulico di frenatura in compressione per alte velocità (sospensione posteriore)	63
5.7.3.	Dispositivo idraulico di frenatura in compressione per basse velocità (sospensione posteriore)	63
5.8.	Regolazione proiettore anteriore	64



1.1. Scopo del manuale

Il presente Manuale fornisce le informazioni necessarie per un uso corretto e sicuro della moto.

Assieme al Manuale viene fornito un Quick Manual tascabile nel quale sono riportate le informazioni minime essenziali per l'uso del veicolo.

Il Manuale viene fornito anche in formato elettronico (.pdf) sul presente CD-Rom e può essere stampato o visualizzato su un qualsiasi PC, sia dotato di sistema Windows che Mac.

Vi raccomandiamo di leggere attentamente il Manuale prima di utilizzare la moto e di sincerarvi che chiunque utilizzi la moto abbia prima fatto lo stesso.

Vi raccomandiamo, infine, di portare sempre con Voi il Quick Manual completandolo con i dati identificativi vostri e della motocicletta.



Copyright
MV AGUSTA Motor Spa
Tutti i diritti riservati



1.2. Simbologia

Le parti di testo di particolare importanza, relative alla sicurezza della persona e all'integrità della motocicletta, sono evidenziate con i seguenti simboli:



Pericolo - Attenzione: la mancata o incompleta osservanza di queste prescrizioni può comportare pericolo grave per la propria incolumità e per quella di altre persone.



Cautela - Precauzione: la mancata o incompleta osservanza di queste prescrizioni può comportare un rischio di danni alla motocicletta.

Per indicare le persone autorizzate allo svolgimento delle operazioni di regolazione e/o manutenzione, esse sono contraddistinte dai seguenti simboli:



Informazioni sulle operazioni consentite al motociclista.



Informazioni sulle operazioni che devono essere svolte solo dal personale autorizzato.

Per evidenziare ulteriori informazioni vengono utilizzati i seguenti simboli:



Il simbolo  indica la necessità di utilizzare un attrezzo od un'attrezzatura specifica per il corretto svolgimento dell'operazione descritta.



Il simbolo “ § ” indica il rimando al capitolo identificato dal numero che lo segue.



1.3. Contenuto del CD-Rom

Nel presente CD-Rom troverete, oltre a questo Manuale, il Manuale di Manutenzione, il Quick Manual (di cui viene fornita anche la versione stampata), la Guida delle Concessionarie ed il Libretto di Garanzia.

Al momento della consegna della moto, il Vs. Concessionario vi ha consegnato il Certificato di Garanzia e Pre-Consegna.

Vi preghiamo di conservarlo unitamente ai documenti della moto ed ai futuri tagliandi di manutenzione che vi verranno via via consegnati in occasione degli interventi previsti.

IMPORTANTE

La copia del Certificato di Garanzia e Pre-Consegna destinata alla MV Agusta deve essere compilata dal Concessionario e resa alla fabbrica entro 10 gg. dalla data di immatricolazione.

Le copie dei tagliandi di manutenzione raccomandata devono essere sempre compilati dal Concessionario e resi alla MV Agusta entro 10 gg. dalla data di esecuzione degli interventi.



1

2) numero di matricola motore

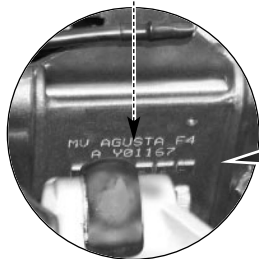

3) dati di omologazione



1) numero di matricola telaio

1.4. Dati di identificazione

- 1) numero di matricola telaio
- 2) numero di matricola motore
- 3) dati di omologazione

► Identificazione motocicletta

La motocicletta è identificata dal numero di matricola del telaio. Per ordinare le parti di ricambio, oltre a questo numero, può essere necessario indicare il numero di matricola motore, il codice colore e il numero di identificazione chiave.

Si consiglia di annotare i dati principali negli spazi sotto riportati.

TELAIO N.: _____

MOTORE N.: _____



► Identificazione chiave della motocicletta

Viene fornita, in duplice copia, una chiave da utilizzare sia per l'avviamento che per l'azionamento di tutte le serrature. Custodire in luogo sicuro la copia di scorta.

La conoscenza del numero di identificazione chiave è essenziale nel caso in cui si renda necessario richiedere un duplicato della chiave a ricambio. Si consiglia di annotare tale numero nel seguente spazio:

CHIAVE N.:

► Identificazione combinazione colori motocicletta

Il codice colore è indispensabile per ordinare le parti di ricambio della carrozzeria. Esso si trova nella parte inferiore sinistra del serbatoio benzina.

Per accedere alla targhetta codice colore, è necessario rimuovere il fianchetto serbatoio sinistro.

Tirare la parte posteriore del fianchetto serbatoio sinistro verso l'esterno come mostrato in figura.



1

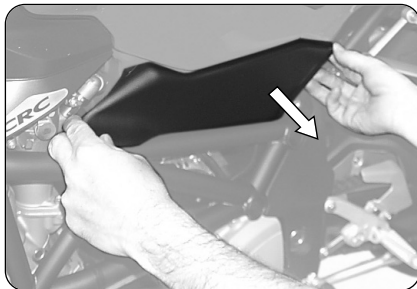



1

Procedere alla rimozione del fianchetto serbatoio sinistro sfilandolo verso la parte posteriore della moto.

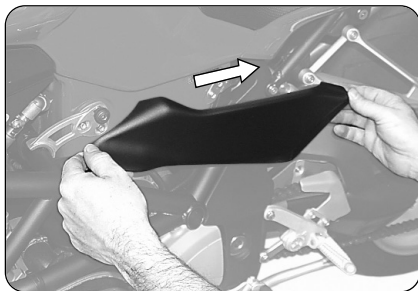

Dopo avere rimosso il fianchetto serbatoio, è possibile accedere alla targhetta codice colore posta sul serbatoio. Su questa targhetta è possibile individuare il codice colore della motocicletta, il quale determina la colorazione delle parti della carrozzeria.

Si consiglia di annotare il codice colore della motocicletta nel seguente spazio:

CODICE COLORE :

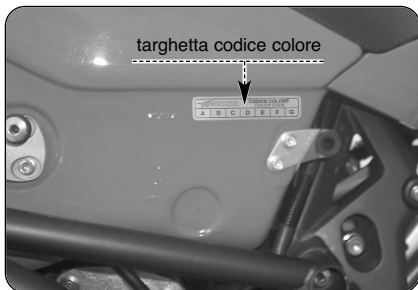



2.1. USO CONSENTITO DEL VEICOLO

La Vs. motocicletta e' stata progettata per un utilizzo esclusivamente stradale ed autostradale.



ATTENZIONE

Saltuariamente e' possibile utilizzare la moto in pista in occasioni non competitive.

In tale caso, tuttavia, a causa delle maggiori sollecitazioni a cui in tale specifico utilizzo la moto e' sottoposta, si raccomanda di far verificare da un Centro Assistenza MV Agusta le condizioni della moto prima e dopo l'uso.

Ogni altro utilizzo e' proibito ed espressamente escluso.

Potete trovare ulteriori informazioni circa l'uso della moto nella sezione 4 del presente Manuale.

2.2. MANUTENZIONE

Per garantire la massima efficienza ed affidabilità del veicolo è essenziale eseguire gli interventi manutentivi previsti nel Manuale di Manutenzione.

MV Agusta raccomanda che tutti gli interventi di manutenzione siano effettuati solo da personale specializzato appartenente ad un Centro Assistenza MV Agusta.

Laddove, viceversa, decidiate di far eseguire gli interventi di manutenzione da officine terze, dovette farVi confermare che le stesse abbiano la capacita' e gli strumenti specifici necessari all'esecuzione di tali interventi.



ATTENZIONE

La garanzia MV Agusta potrebbe non operare laddove officine terze abbiano effettuato interventi sulla moto in modo difforme da quanto previsto dalle Circolari Tecniche e nei relativi Manuali di Officina MV Agusta.

**2.3. ACCESSORI E MODIFICHE****ATTENZIONE**

MV Agusta vieta di apportare qualsiasi modifica alle proprie motociclette.

Questo è necessario al fine di salvaguardare la sicurezza dei suoi Clienti.

È tuttavia possibile personalizzare la Vs. motocicletta attingendo dal ricco catalogo Accessori MV Agusta.

**ATTENZIONE**

L'installazione di alcuni di questi accessori può invalidare l'omologazione della moto e, pertanto, comportare la sua non ulteriore utilizzabilità su strada pubblica.

In caso di dubbio Vi consigliamo di consultarVi con il vostro Concessionario MV Agusta di fiducia per decidere quali accessori siano più adatti alle Vs. esigenze.

2.4. CARICO VEICOLO

Il veicolo è progettato per l'impiego da parte del pilota e di un eventuale passeggero.

Per un utilizzo in piena sicurezza e nel rispetto delle norme del codice stradale è obbligatorio non superare mai la massa massima tecnicamente ammissibile del veicolo, il cui valore è di seguito riportato:

BRUTALE 910 S

Peso massimo totale **370 kg**

Peso massimo trasportabile **180 kg**

Il peso massimo totale rappresenta la somma dei seguenti pesi, secondo la direttiva europea CEE 92/61:

- peso del motociclo;
- peso del pilota;
- peso del passeggero;
- peso del carico e degli accessori.

**ATTENZIONE**

Dato che il carico ha un impatto enorme sulla manovrabilità, la frenata, le prestazioni e le caratteristiche di sicurezza del vostro mezzo, tenere sempre presenti le seguenti precauzioni.

- **NON SOVRACCARICARE MAI IL MOTOCICLO!** L'uso di un motociclo sovraccaricato può provocare danneggiamenti dei pneumatici, perdite del controllo o infortuni gravi. Verificare che il peso totale del pilota, del passeggero, del carico e degli accessori non superi il carico massimo specificato per il motociclo.



3.1. Posizione comandi e strumenti

3

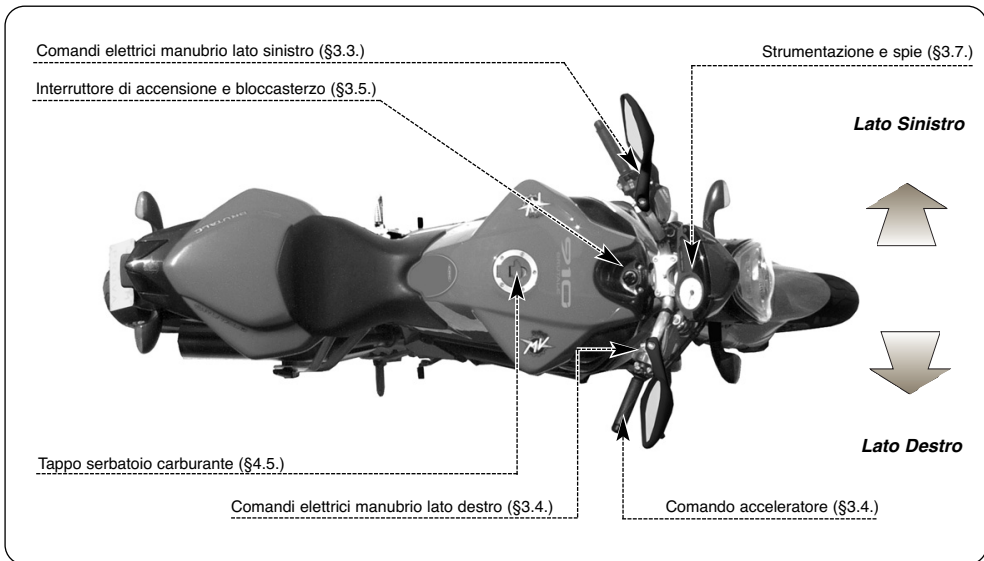

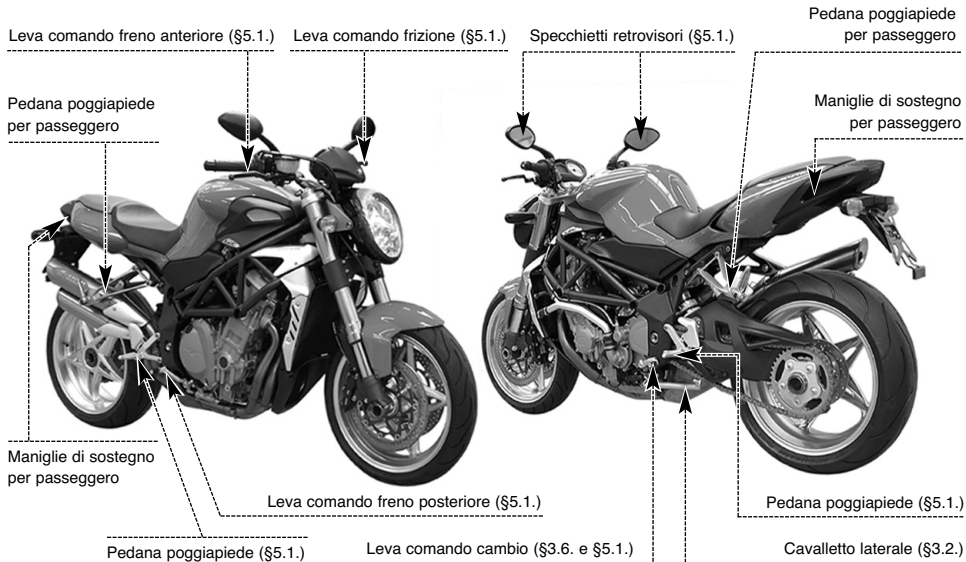



3.2. Cavalletto laterale

Il cavalletto laterale è dotato di un interruttore di sicurezza che impedisce la partenza con il cavalletto abbassato.

Nel caso in cui a motore avviato e nella condizione di cavalletto abbassato si azioni il cambio per porsi in movimento, l'interruttore interrompe la corrente al motore provocandone l'arresto.

Nel caso in cui la moto si trovi invece in condizione di stazionamento (cavalletto abbassato) e con un rapporto del cambio inserito, l'interruttore impedisce l'avviamento del motore evitando ogni rischio di caduta accidentale del veicolo.

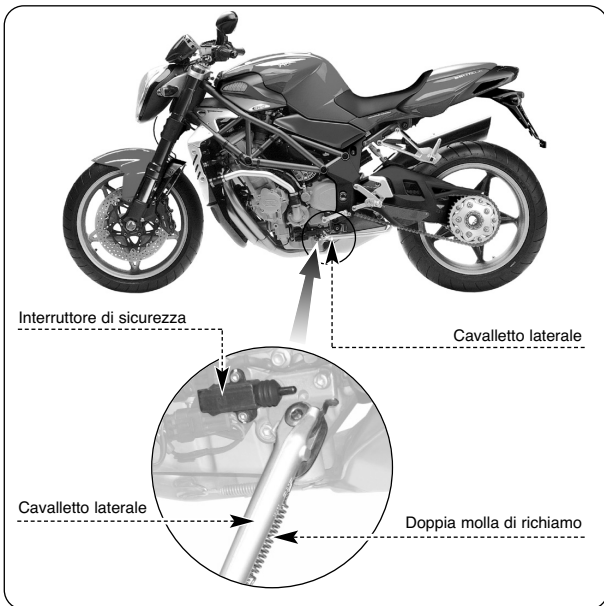



3.3. Comandi al manubrio lato sinistro

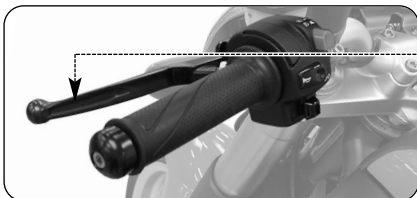

Leva frizione

Accostare o allontanare dalla manopola per comandare la frizione.

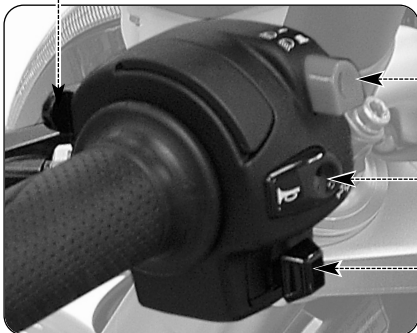

Pulsante lampeggio fari

Premere il pulsante a ripetizione.

Pulsante abbagliante/anabbagliante

Pulsante in fuori  : anabbagliante 

Pulsante in dentro  : abbagliante 

Pulsante avvisatore acustico

Premere per attivare l'avvisatore acustico.

Leva indicatori di direzione

Spostando la leva a destra o a sinistra si attivano gli indicatori di direzione destri o sinistri. La leva torna al centro; premere per disattivare gli indicatori.



Pulsante Lampeggio Faro

Questa funzione serve a richiamare l'attenzione degli altri utenti della strada in caso di possibili situazioni di pericolo; con l'abbagliante acceso tale funzione non è attiva.

Pulsante Abbagliante/Anabbagliante

Normalmente viene attivata la funzione anabbagliante; quando le condizioni di traffico e di percorso lo consentono, può essere attivata la funzione abbagliante agendo sul pulsante.

Leva Indicatori di Direzione

Questa funzione permette di segnalare agli altri utenti della strada l'intenzione di cambiare direzione o corsia di marcia.



ATTENZIONE

Il mancato uso o la mancata disattivazione degli indicatori di direzione al momento opportuno può essere causa di incidenti; gli altri utenti della strada potrebbero infatti trarre conclusioni sbagliate riguardo all'effettivo tragitto del veicolo. Azionare sempre gli indicatori di direzione prima di svoltare o cambiare corsia.

Accertarsi poi di disattivare gli indicatori non appena effettuata la suddetta manovra.

Pulsante Avvisatore Acustico

Questa funzione serve a richiamare l'attenzione degli altri utenti della strada in caso di possibili situazioni di pericolo.

Leva Frizione

Questa leva, attraverso un dispositivo a controllo idraulico, consente l'innesto ed il disinnesto della frizione.



3.4. Comandi al manubrio lato destro

Leva freno anteriore

Avvicinare alla manopola per azionare il freno anteriore.

Comando acceleratore

Ruotare per regolare l'alimentazione del motore.

Leva avviamento a freddo del motore (Choke)

Ruotare in senso orario per l'avviamento a freddo del motore. Dopo alcuni secondi riportare la leva nella sua posizione iniziale.

Interruttore stop motore

Se azionato arresta il motore e ne impedisce l'avviamento.

Pulsante avviamento motore

Premuto avvia il motore. Va rilasciato appena avviato. Con motore avviato, ripremendo, si selezionano le funzioni del display.

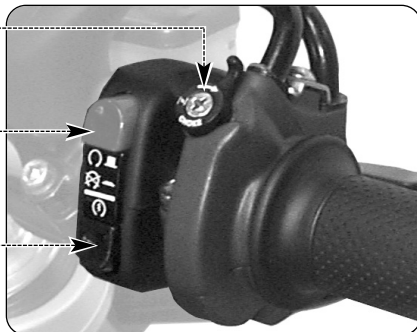
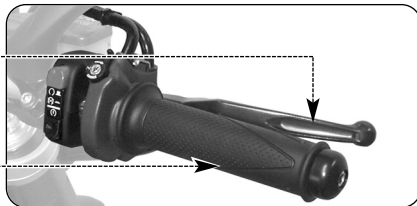



Interruttore Stop Motore

Questa funzione permette di arrestare il motore in caso di emergenza; in questo modo viene disattivato il circuito di accensione impedendo il riavvio del motore. Per poter effettuare l'avviamento riportare il pulsante in posizione di riposo.

NOTA

In condizioni normali non utilizzare questo dispositivo per l'arresto del motore.

Pulsante Avviamento Motore

Questo dispositivo consente l'avviamento del motore; inoltre a motore avviato esso permette di selezionare le funzioni del display presente nella strumentazione di bordo.



CAUTELA

Per evitare danni all'impianto elettrico non tenere premuto il pulsante per un tempo superiore ai 5 secondi consecutivi.

Se il motore non si avvia dopo alcuni tentativi, consultare il capitolo "GUASTI" nel presente manuale.

Leva Avviamento a freddo del Motore (Choke)

Il dispositivo facilita l'avviamento a freddo agendo sull'alimentazione.

NOTA

Questa funzione deve essere mantenuta attiva per un tempo limitato ed in ogni caso dipendente dalla temperatura del motore e dell'ambiente esterno. Quando il regime minimo di rotazione è sufficiente a mantenere avviato il motore, è opportuno disattivare il comando.

**Comando Acceleratore**

Questo dispositivo consente di regolare l'alimentazione del motore variandone così il regime di rotazione. Per azionare il dispositivo occorre ruotare la manopola dalla posizione di riposo, corrispondente alla condizione di regime minimo del motore.

Nella condizione di avviamento a freddo (Choke attivo), la ripetuta rotazione della manopola nel senso di chiusura del gas permette di riportare la leva di choke in posizione di riposo.

Leva Freno Anteriore

Questo comando permette di azionare attraverso un circuito idraulico l'impianto frenante della ruota anteriore.



3.5. Interruttore accensione e bloccasterzo



ATTENZIONE: Non applicare portachiavi o altri oggetti alla chiave di accensione per non creare ostacoli alla rotazione dello sterzo.



ATTENZIONE: Non tentare di cambiare alcuna funzione dell'interruttore durante la marcia; si potrebbe incorrere nella perdita di controllo del mezzo.

3

Interruttore accensione e bloccasterzo

Posizione "ON"

Posizione "OFF"

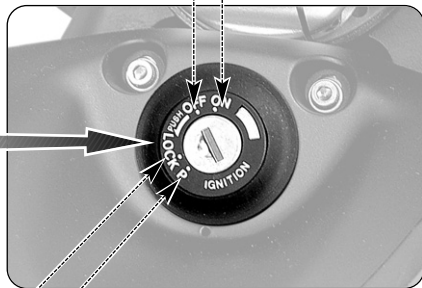
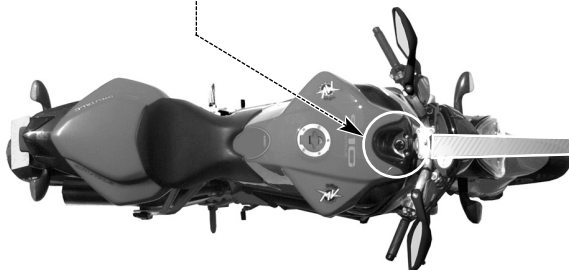

Posizione "LOCK"

Posizione "P"



L'interruttore di accensione attiva e disattiva il circuito elettrico ed il bloccasterzo; le quattro posizioni di comando sono di seguito descritte.

Posizione "OFF"

Tutti i circuiti elettrici sono disattivati. La chiave può essere estratta.



Posizione "ON"

Tutti i circuiti elettrici sono attivati, la strumentazione e le spie eseguono l'autodiagnosi; il motore può essere avviato. La chiave non può essere estratta.



3



Cautela-Precauzione: Non lasciare la chiave sulla posizione "ON" a motore spento per lungo tempo, allo scopo di evitare il danneggiamento dei componenti elettrici della motocicletta.

**Posizione "LOCK"**

Ruotare il manubrio a sinistra. Premere leggermente la chiave e contemporaneamente ruotarla in posizione "LOCK".

Tutti i circuiti elettrici sono disattivati e lo sterzo è bloccato. La chiave può essere estratta.

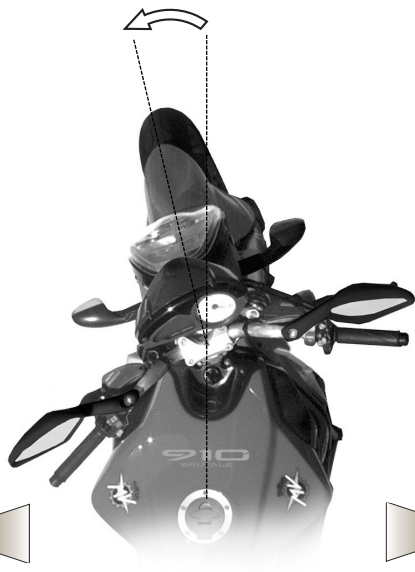
3**Lato Sinistro****Lato Destro**



Posizione “P”

Ruotare la chiave dalla posizione “LOCK” alla posizione “P”.

Tutti i circuiti elettrici sono disattivati tranne le luci di parcheggio (luci di posizione).

Lo sterzo è bloccato e la chiave può essere estratta.



CAUTELA

Non lasciare la chiave sulla posizione “P” per lungo tempo, allo scopo di evitare di scaricare la batteria della motocicletta.





3.6. Comando cambio

La posizione **N** "Neutral" corrisponde alla posizione di folle segnalata dalla relativa spia cruscotto.

Spostando la leva del cambio verso il basso si innesta la prima marcia.

Analogamente, spostando la leva verso l'alto si innesta la seconda marcia; continuando più volte a spostare la leva verso l'alto si innestano, in modo sequenziale, tutte le altre marce fino alla sesta.

3



Leva comando cambio

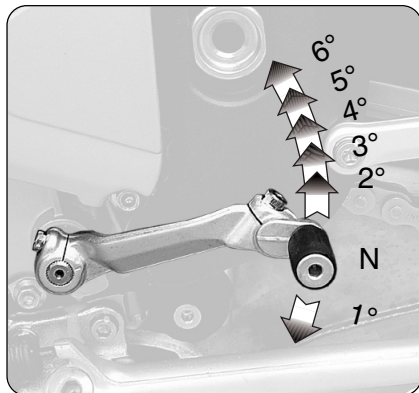



3.7. Strumentazione e spie

Gli strumenti e le spie si attivano ruotando la chiave di accensione in posizione "ON". Dopo un check-up iniziale (~ 7 secondi) le informazioni corrispondono alle condizioni generali della motocicletta in quel momento.

Spie luminose di indicazione (§3.7.1.)

Pulsante "SET" (§3.7.2.)

Display multifunzione (§3.7.2.)

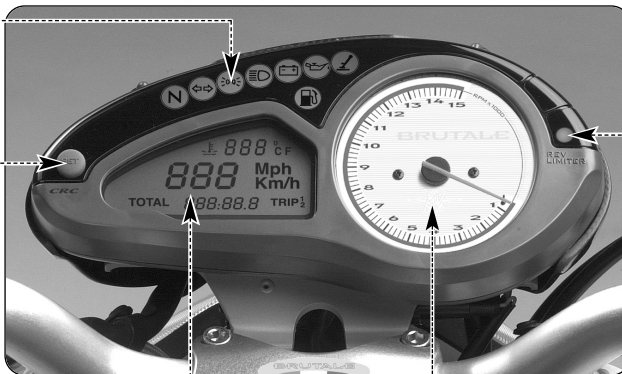

Spia luminosa di indicazione (§3.7.1.)

Contagiri

3



3.7.1. Spie luminose di indicazione

Spia luce abbagliante (blu)

Si accende quando è attivata la luce abbagliante.

Spia luce anabbagliante (verde)

Si accende quando è attivata la luce anabbagliante.

Spia cambio in folle (verde)

Si accende quando il cambio è nella posizione folle "Neutral".

Spia indicatori di direzione (verde)

Si accende quando sono attivati gli indicatori di direzione.

Spia riserva carburante (arancio)

Si accende quando nel serbatoio sono contenuti circa 4 litri di carburante.

Spia carica batteria (rosso)

Si accende quando l'alternatore non fornisce la corrente elettrica sufficiente a caricare la batteria.

Se l'accensione avviene durante la marcia rivolgersi ad un centro assistenza autorizzato.

Spia apertura cavalletto laterale (rosso)

Si accende quando il cavalletto è abbassato.

Spia limitatore giri (rosso)

Si accende quando il motore supera i 11300 rpm; il limitatore interviene a 12000 rpm.

Spia pressione olio motore (rosso)

Si accende quando l'olio è ad una pressione insufficiente.



Pericolo - Attenzione: Se si accende durante la marcia, fermarsi immediatamente, controllare il livello dell'olio e se necessario farne effettuare il rabbocco presso un centro assistenza autorizzato MV Agusta (vedi §3.8). Se la spia si accende nonostante il livello sia corretto, non proseguire la marcia e contattare un centro assistenza autorizzato MV Agusta.

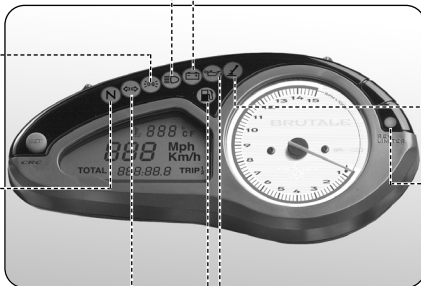



3.7.2. Display multifunzione

Tachimetro

Indica la velocità. Il valore può apparire in chilometri orari (Km/h) oppure in miglia orarie (Mph). Il valore a fondo scala è di 299 Km/h (186 Mph).

Pulsante "SET"

Se premuto, consente di selezionare le cifre del display per effettuare le regolazioni. Se premuto nuovamente consente di confermare le cifre impostate.

Contachilometri totale "TOTAL"

Indica la percorrenza totale; da 0 a 99999.9 (Km o mi)

Contachilometri parziale 1 "TRIP 1"

Indica la percorrenza parziale; da 0 a 9999.9 (Km o mi)

Contachilometri parziale 2 "TRIP 2"

Indica la percorrenza parziale; da 0 a 9999.9 (Km o mi)

Orologio

Indica l'ora (0÷24).

Termometro

Indica la temperatura del liquido di raffreddamento. Il valore può apparire in gradi centigradi (° C) oppure in gradi fahrenheit (° F).

Il campo di indicazione è compreso tra 40° e 140° C (104° e 284° F):

- sotto i 40° C (104° F) l'indicazione non appare ma appaiono tre linee lampeggianti; è il segnale di temperatura molto bassa;
- tra 40° e 49° C (104° e 120° F) l'indicazione lampeggia; è il segnale di temperatura bassa;
- tra i 50° e 111° C (122° e 232° F) l'indicazione è fissa;
- tra 112° e 140° C (234° e 284° F) l'indicazione lampeggia; è il segnale di temperatura alta.

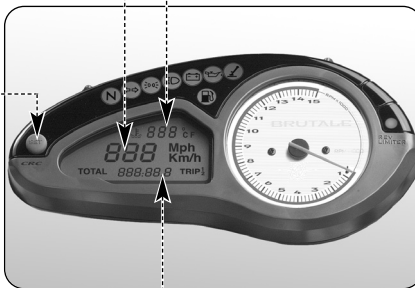

Pericolo - Attenzione: se la temperatura supera i 120° C (248° F) arrestare la motocicletta e controllare il livello del liquido di raffreddamento. Nel caso in cui fosse necessario rabboccarlo, rivolgersi presso un centro assistenza autorizzato MV Agusta (vedi § 3.8). Se la spia si accende nonostante il livello sia corretto, non proseguire la marcia e contattare un centro assistenza autorizzato MV Agusta.



3.8. Tabella lubrificanti e liquidi

Descrizione	Prodotto consigliato	Specifiche
Olio lubrificazione motore	AGIP RACING 4T 10W/60 (*)	SAE 10W/60 - API SJ
Liquido di raffreddamento	AGIP ECO - PERMANENT	Glicole - Etilenico diluito con 50% di acqua distillata
Fluido comando frizione e freni	AGIP BRAKE FLUID DOT4	DOT4
Olio lubrificazione catena	MOTUL CHAIN LUBE ROAD	-

* : Per la reperibilità del prodotto consigliato, MV Agusta consiglia di rivolgersi direttamente ai propri concessionari autorizzati. L'olio motore AGIP Racing 4T 10W/60 è stato realizzato appositamente per il motore del motociclo F4. Qualora il lubrificante descritto non fosse reperibile, MV Agusta consiglia l'utilizzo di olii completamente sintetici con caratteristiche conformi o superiori alle seguenti normative:

- Conforme API SJ
- Conforme ACEA A3
- Conforme JASO MA
- Gradazione SAE 20 W-50 o 10 W-60

NOTA

Le specifiche sopra indicate devono essere riportate, da sole od insieme ad altre, sul contenitore dell'olio lubrificante.





4.1. Uso della motocicletta

In questa sezione vengono esposti gli argomenti principali per il corretto uso della motocicletta.



ATTENZIONE

Il motociclo F4 BRUTALE 910 S presenta elevate caratteristiche di potenza e prestazioni; per il suo uso è pertanto richiesto un'adeguato livello di conoscenza del mezzo. Al momento del primo utilizzo di questo veicolo è necessario adottare un atteggiamento prudente. Uno stile di guida aggressivo o avventato può esporre al rischio di incidenti, compromettendo la Vostra incolumità e quella di altre persone.



ATTENZIONE

LE LIMITAZIONI RELATIVE ALL'USO CONSENTITO DEL VEICOLO SONO RIPORTATE NELLA SEZIONE "INFORMAZIONI PER LA SICUREZZA".



4.2. Rodaggio



Cautela - Precauzione: l'inosservanza delle indicazioni di seguito riportate può pregiudicare la durata e le prestazioni della motocicletta.

È uso comune considerare il rodaggio come una fase applicata al solo motore. In realtà esso va considerato anche per altre parti importanti della moto, in particolare i pneumatici, i freni, la catena di trasmissione, ecc. Nei primissimi chilometri adottare una guida tranquilla.

□ Da 0 a 500 Km (da 0 a 300 mi) (A)

Durante questa percorrenza variare frequentemente il regime di rotazione del motore. Se possibile, privilegiare percorsi leggermente collinosi, con molte curve ed evitare lunghi tratti rettilinei.

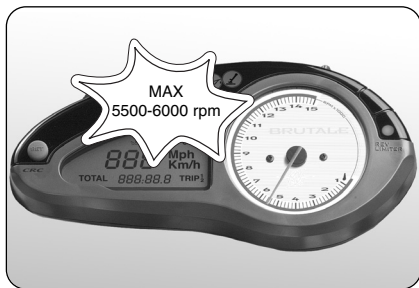

ATTENZIONE

I pneumatici nuovi devono essere sottoposti ad un adeguato rodaggio per raggiungere la completa efficienza. Evitare le accelerazioni, le curve e le frenate brusche per i primi 100 km. Se non si osserva un periodo di rodaggio iniziale dei pneumatici, si rischia di slittare o di perdere il controllo del veicolo con conseguente pericolo di incidenti.



□ **Da 500 a 1000 Km (da 300 a 600 mi)**

Durante questa percorrenza evitare di mantenere a lungo il motore sotto sforzo.

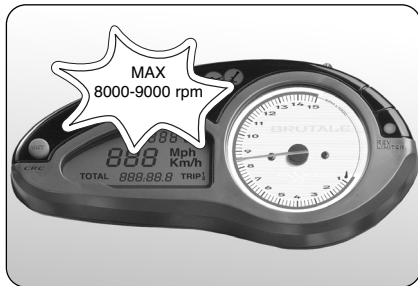

□ **Da 1000 a 2500 Km (da 600 a 1600 mi)**

Durante questa percorrenza è possibile pretendere maggiori prestazioni dal motore, senza tuttavia superare il regime di rotazione indicato.

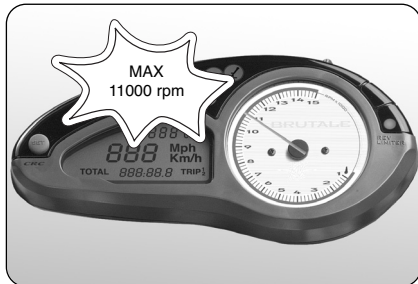



4.3. Avviamento motore



ATTENZIONE

Far funzionare il motore in un ambiente chiuso può essere pericoloso. I gas di scarico contengono monossido di carbonio, un gas incolore ed inodore che può provocare decessi o infortuni gravi. Fare funzionare il motore solo all'esterno, all'aria aperta.

4

► Ruotando l'interruttore d'accensione in posizione "ON", la strumentazione e le spie eseguono l'autodiagnosi; durante questa fase, accertarsi dell'accensione di tutte le spie presenti sul cruscotto. Affinché il sistema di interruzione del circuito di accensione dia il consenso all'avviamento, deve essere stata soddisfatta una delle seguenti condizioni:

- Il cambio è in posizione di folle.
- Il cambio è innestato su una marcia con la leva della frizione tirata ed il cavalletto laterale alzato.

☐ Avviamento a freddo

► Ruotare la leva "CHOKE", senza ruotare la manopola dell'acceleratore e premere il pulsante.





► Appena il motore si è avviato, rilasciare il pulsante e dopo un breve riscaldamento riportare la leva “CHOKE” nella sua posizione iniziale.

❑ **Avviamento a caldo**

- Premere il pulsante senza ruotare la manopola dell'acceleratore.
- Appena il motore si è avviato rilasciare il pulsante.



Cautela - Precauzione:

- Per evitare danni all'impianto elettrico non azionare l'avviamento per più di 5 secondi consecutivi.

- Non far funzionare a lungo il motore a motocicletta ferma. Il conseguente surriscaldamento può danneggiare i componenti interni del motore.

È preferibile portare il motore alla temperatura di esercizio ponendosi in marcia ad andatura ridotta.

- Per allungare al massimo la vita del motore, non accelerare a fondo quando il motore è freddo.





4.4. Selezione e modifica delle funzioni display

La strumentazione prevede la possibilità di intervenire su alcuni dei parametri principali di misurazione.

Le operazioni possibili sono :

- Selezione delle funzioni:

Contachilometri	Totale	"TOTAL"
Contachilometri	Parziale 1	"TRIP 1"
Contachilometri	Parziale 2	"TRIP 2"
Orologio		

- Regolazione delle unità di misura relative a:

Velocità
Distanza percorsa
Temperatura

- Azzeramento delle funzioni contachilometri parziali:

Contachilometri	Parziale 1	"TRIP 1"
Contachilometri	Parziale 2	"TRIP 2"

- Regolazione della funzione orologio.





4.4.1. Selezione funzioni display

La selezione riguarda le funzioni:

- Contachilometri Totale "TOTAL"
- Contachilometri Parziale 1 "TRIP 1"
- Contachilometri Parziale 2 "TRIP 2"
- Orologio

► La visualizzazione delle funzioni "TOTAL", "TRIP 1" e "TRIP 2", avviene premendo il pulsante di avviamento motore. Agendo su tale pulsante appaiono sul display le funzioni in modo ciclico. Selezionare la funzione desiderata.

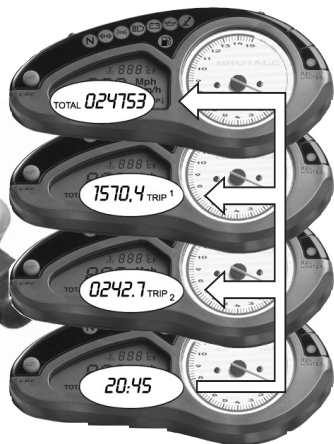

4



ATTENZIONE

Le operazioni di modifica o regolazione delle funzioni display devono essere eseguite con motore acceso, cambio in folle, motocicletta ferma e piedi a terra. È vietato cambiare le impostazioni del display durante la marcia.



4.4.2. Regolazione delle unità di misura

È possibile eseguire la modifica delle unità di misura.



ATTENZIONE

Le operazioni di modifica o regolazione delle funzioni display devono essere eseguite con motore acceso, cambio in folle, motocicletta ferma e piedi a terra. È vietato cambiare le impostazioni del display durante la marcia.



□ Tachimetro (Km/h - Mph)

- ▶ Premere ripetutamente il pulsante di avviamento motore fino alla visualizzazione della funzione contachilometri totale "TOTAL".
- ▶ Premere il pulsante "SET"; l'unità di misura del tachimetro inizia a lampeggiare.





► Premere il pulsante di avviamento motore per passare da Km/h a Mph o viceversa. Variando l'unità di misura del tachimetro, varia automaticamente anche quella del contachilometri (totale e parziale).

Si ricorda che $1 \text{ mi} = 1,609 \text{ Km}$

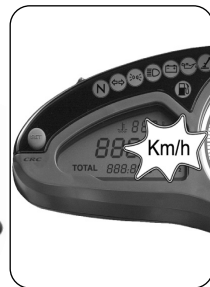

4

► Premere il pulsante "SET"; l'unità di misura del tachimetro viene confermata e l'unità di misura del termometro inizia a lampeggiare. Si può procedere alla regolazione successiva.





□ Termometro (° C - ° F)

► Premere il pulsante di avviamento motore per passare da ° C a ° F o viceversa.

Si ricorda che $T (°F) = 1,8 \cdot t (°C) + 32$



4

► Premere il pulsante “SET” per confermare l'unità di misura.





4.4.3. Azzeramento delle funzioni contachilometri parziali

I valori delle funzioni “TRIP 1” e “TRIP 2” possono essere azzerati nel modo seguente.



ATTENZIONE

Le operazioni di modifica o regolazione delle funzioni display devono essere eseguite con motore acceso, cambio in folle, motocicletta ferma e piedi a terra. È vietato cambiare le impostazioni del display durante la marcia.

► Premendo il pulsante di avviamento motore attivare la funzione “TRIP 1”.

► Premere il pulsante di avviamento motore per un tempo superiore ai quattro secondi; il valore “TRIP 1” inizia a lampeggiare.





► Premendo ora il pulsante di avviamento motore per un tempo inferiore a quattro secondi il valore si azzerava. Se invece si preme il pulsante di avviamento motore per un tempo superiore ai quattro secondi la procedura di azzeramento viene interrotta.



4

► Premendo il pulsante di avviamento motore attivare la funzione "TRIP 2".





► Premere il pulsante di avviamento motore per un tempo superiore ai quattro secondi; il valore "TRIP 2" inizia a lampeggiare.



► Premendo ora il pulsante di avviamento motore per un tempo inferiore a quattro secondi il valore si azzerava. Se invece si preme il pulsante di avviamento motore per un tempo superiore ai quattro secondi la procedura di azzeramento viene interrotta.





4.4.4. Regolazione della funzione orologio

E' possibile eseguire la regolazione della funzione orologio.



ATTENZIONE

Le operazioni di modifica o regolazione delle funzioni display devono essere eseguite con motore acceso, cambio in folle, motocicletta ferma e piedi a terra. È vietato cambiare le impostazioni del display durante la marcia.



► Premere ripetutamente il pulsante di avviamento motore fino alla visualizzazione della funzione orologio.

► Premere il pulsante “SET”; la prima cifra dell'ora inizierà a lampeggiare.





► Premere il pulsante di avviamento motore per la regolazione della cifra; rilasciare appena si raggiunge la cifra desiderata.

NOTA

Per ottenere lo scorrimento veloce della cifra selezionata tenere premuto il pulsante di avviamento motore per oltre due secondi.

► Premere il pulsante “SET” per la conferma e per procedere alla regolazione della cifra successiva.

► Ripetere la procedura per regolare la seconda cifra dell'ora, la prima e la seconda cifra dei minuti.

► Premere il pulsante “SET” per confermare la regolazione dell'ora e per interrompere la selezione (il lampeggio).

NOTA

La strumentazione dispone di una memoria integrale che conserva tutti i parametri anche a motore spento. Ad eccezione dell'orologio, che viene azzerato, tutti gli altri parametri rimangono in memoria anche in caso di scollegamento della batteria.

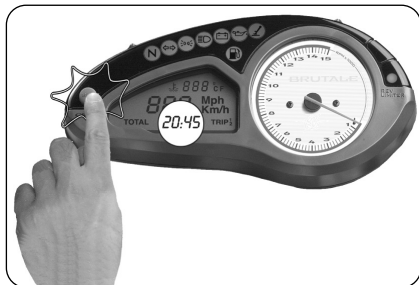



4.5. Rifornimento carburante



Pericolo - Attenzione: la benzina e i suoi vapori sono estremamente infiammabili e nocivi. Evitare il contatto e l'inalazione. Durante il rifornimento spegnere il motore, non fumare, tenere lontane fiamme, scintille e fonti di calore. Effettuate il rifornimento all'aperto o in locale ben ventilato.



Cautela - Precauzione: utilizzare esclusivamente benzina super senza piombo con un numero di ottano (R.O.N.) di 95 o più. Tale necessità è ricordata da un punto verde sul lato inferiore del tappo serbatoio.

- ▶ Sollevare il coperchio parapolvere.
- ▶ Inserire la chiave e ruotarla in senso orario.

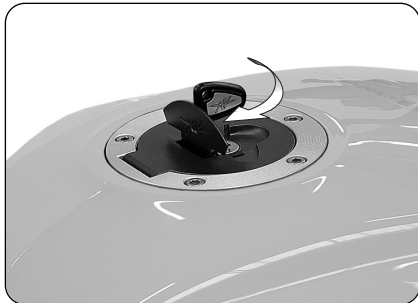
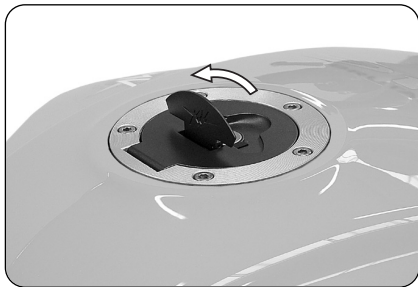



► Sollevare il tappo ed eseguire il rifornimento di carburante.



ATTENZIONE: Un riempimento eccessivo del serbatoio può far traboccare il carburante a causa dell'espansione dovuta al calore del motore o all'esposizione della motocicletta alla luce solare. Eventuali fuoriuscite di carburante possono provocare incendi. Il livello del carburante nel serbatoio non deve mai superare la base del bocchettone di riempimento.

► Dopo il rifornimento premere il tappo verso il basso ruotando contemporaneamente la chiave in senso orario per facilitare la chiusura. Quindi rilasciare la chiave ed estrarla.



Cautela-Precauzione: Asciugare subito con un panno pulito l'eventuale carburante versato, in quanto può deteriorare le superfici verniciate o di plastica.



ATTENZIONE: Verificare che il tappo del serbatoio del carburante sia chiuso correttamente prima di utilizzare il motociclo.

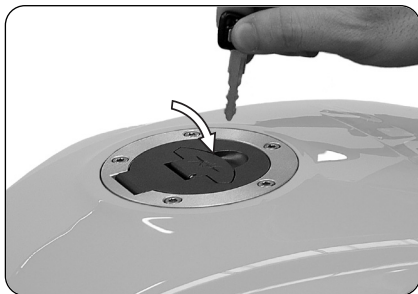
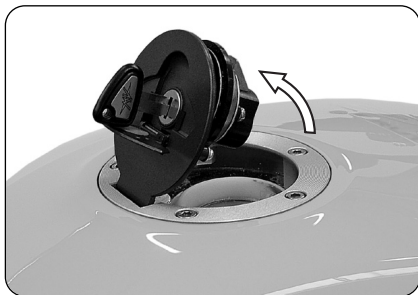



4.6. Accesso al vano portaoggetti

► Inserire la chiave nella serratura.

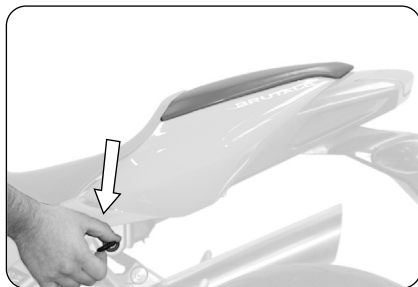

► Ruotare la chiave in senso orario e contemporaneamente premere leggermente sul sellino del passeggero. Sollevare il sellino.





► Estrarre il sellino passeggero.

Per il rimontaggio del particolare osservare le seguenti indicazioni :

- Ruotare la chiave nella serratura
- Premere il sellino passeggero
- Rilasciare la chiave
- Premere nuovamente il sellino assicurandosi di averlo saldamente agganciato alla struttura.



4

**ATTENZIONE**

Dopo aver rimosso o sollevato il sellino passeggero, e comunque prima di ogni utilizzo della moto, assicurarsi che il componente sia stato posizionato correttamente e che risulti ben ancorato alla struttura portante del veicolo.



4.7. Sosta della motocicletta

☐ Sosta con cavalletto laterale



ATTENZIONE

Parcheggiare la motocicletta in condizioni di sicurezza e su terreno stabile. Per la sosta in pendenza parcheggiare con la ruota anteriore a monte e con la prima marcia inserita; ricordarsi di riportare il cambio in folle prima di riavviare la moto. Non lasciare il veicolo incustodito con la chiave di accensione inserita nel quadro.

- ▶ Abbassare il cavalletto col piede fino alla battuta ed inclinare lentamente la motocicletta per porre il piedino di appoggio in contatto col suolo.

Quando il veicolo è in sosta sul cavalletto laterale, è pericoloso sedere a bordo gravando perciò col proprio peso sull'unico appoggio di stazionamento. Prima di mettersi in marcia verificare il funzionamento dell'interruttore di sicurezza accertandosi che la spia di apertura cavalletto laterale sul cruscotto si spenga; in ogni caso verificare che il cavalletto sia rientrato. Se si nota una disfunzione, fare controllare l'impianto da un concessionario MV Agusta prima di utilizzare il mezzo.

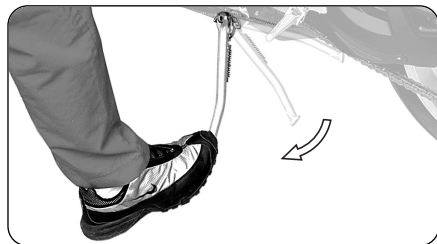



□ Sosta con cavalletto posteriore

Inserire il perno del cavalletto nel foro dell'asse ruota posteriore dal lato sinistro della motocicletta; appoggiare il cavalletto al suolo e facendo forza su di esso sollevare il veicolo fino al raggiungimento della condizione di stabilità.



ATTENZIONE

Questa operazione deve essere eseguita da due persone.

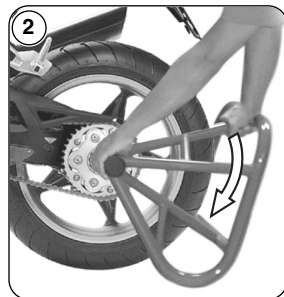
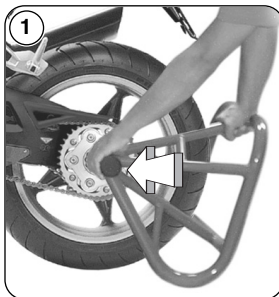



5.1. Elenco regolazioni

La motocicletta possiede un'ampia possibilità di regolazioni che possono migliorare l'ergonomia, l'assetto e la sicurezza.

Tuttavia, poiché una errata regolazione di componenti particolarmente importanti può creare una situazione di pericolo, alcune di queste regolazioni sono riservate soltanto ai Centri Assistenza MV Agusta.



ATTENZIONE

Tutte le regolazioni devono essere effettuate a veicolo fermo.



(F) Regolazione specchietto retrovisore (§5.5.)

(A) Regolazione leva freno anteriore (§5.3.)

(C) Regolazione pedana
destra (§5.2.)

(H) Regolazione sospensione
posteriore (§5.7.)

(E) Regolazione leva freno
posteriore (§5.2.)

(G) Regolazione sospensione
anteriore (§5.6)

(M) Orientamento
faro (§5.8.)

(G) Regolazione sospensione
anteriore (§5.6)

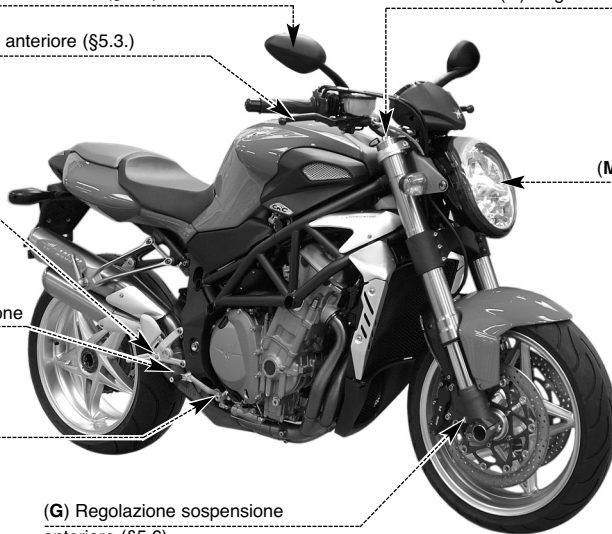



(F) Regolazione specchietto retrovisore (§5.5.)

(H) Regolazione sospensione posteriore (§5.7.)

(B) Regolazione leva
frizione (§5.4.)

(D) Regolazione leva
cambio (§5.2.)

(C) Regolazione pedana sinistra (§5.2.)

(L) Regolazione
catena (§5.2.)





5.2. Tabella delle regolazioni

	A - Regolazione leva freno anteriore: per ottimizzare la presa in funzione delle esigenze del motociclista (§5.3).
	B - Regolazione leva frizione: per ottimizzare la presa in funzione delle esigenze del motociclista (§5.4).
	C - Regolazioni pedane poggipiedi (destra e sinistra): per ottimizzare la posizione dei piedi in funzione delle esigenze del motociclista.
	D - Regolazione leva cambio: per ottimizzare il movimento del comando in funzione delle esigenze del motociclista.
	E - Regolazione leva freno posteriore: per ottimizzare il movimento del comando in funzione delle esigenze del motociclista.
	F - Regolazione specchietti retrovisori: per ottimizzare l'orientamento (§5.5). ATTENZIONE: Non intervenire sulla vite di fissaggio dello specchietto retrovisore al manubrio. In caso di necessità, rivolgersi ad un concessionario MV Agusta.
	G - Regolazione sospensione anteriore: per adattare la risposta alle preferenze del motociclista si possono regolare: <ul style="list-style-type: none">- precarico molla (§5.6.1.)- dispositivo idraulico di frenatura in estensione (§5.6.2.)- dispositivo idraulico di frenatura in compressione (§5.6.3.)
	H - Regolazione sospensione posteriore: per adattare la risposta alle preferenze del motociclista si possono regolare: <ul style="list-style-type: none">- precarico molla- altezza assetto
	<ul style="list-style-type: none">- dispositivo idraulico di frenatura in estensione (§5.7.1.)- dispositivo idraulico di frenatura in compressione per alte velocità (§5.7.2.)- dispositivo idraulico di frenatura in compressione per basse velocità (§5.7.3.)
	L - Regolazione catena: per l'efficienza e la sicurezza della trasmissione.
	M - Orientamento faro: per regolare la profondità del fascio luminoso in funzione dell'assetto (§5.8).



5.3. Regolazione leva freno anteriore

Tirare la leva per neutralizzare la spinta della molla e, contemporaneamente, regolarne la posizione ruotando la ghiera in senso orario o antiorario. In senso orario: la leva si allontana dalla manopola. In senso antiorario: la leva si avvicina alla manopola.

5.4. Regolazione leva frizione

Tirare la leva per neutralizzare la spinta della molla e, contemporaneamente, regolarne la posizione ruotando la ghiera in senso orario o antiorario. In senso orario: la leva si allontana dalla manopola. In senso antiorario: la leva si avvicina alla manopola.

5

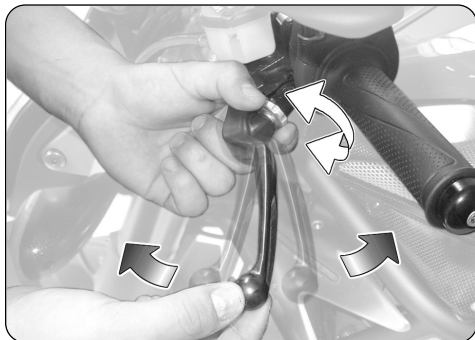
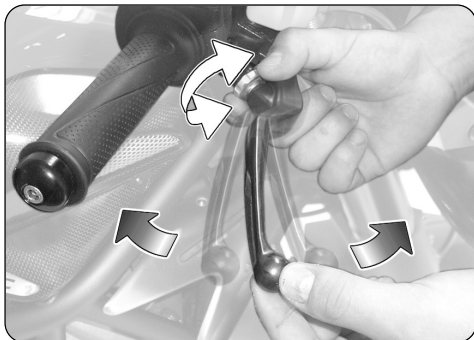



5.5. Regolazione specchietti retrovisori

Premere delicatamente nei punti evidenziati per regolare la posizione nelle quattro direzioni.

Eseguire la regolazione su entrambi gli specchietti retrovisori. Per rendere ottimale la messa a punto si consiglia di eseguire la regolazione salendo sul veicolo.

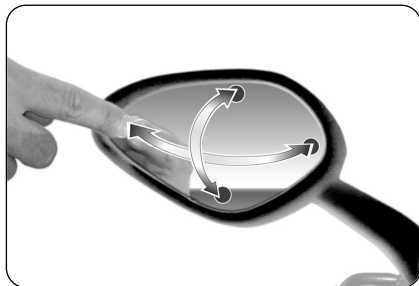

5



5.6. Regolazione sospensione anteriore



ATTENZIONE: È essenziale che i registratori di entrambi gli steli della forcella siano regolati nella stessa posizione.

NOTA: La regolazione delle sospensioni deve essere preferibilmente effettuata con il serbatoio carburante pieno.

Dispositivo idraulico di frenatura in estensione

Precarico molla

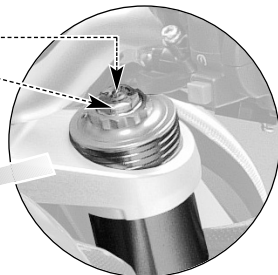

Dispositivo idraulico di frenatura in compressione

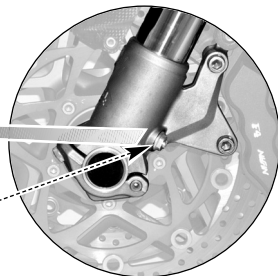



5.6.1. Precarico molla

La regolazione deve essere effettuata partendo dalla posizione standard. Per trovare tale posizione, occorre ruotare in senso antiorario fino a fondo corsa, quindi in senso orario fino alla posizione standard (vedi tabella allegata). Ruotare in senso orario per aumentare il precarico molla, oppure ruotare in senso antiorario per diminuirlo.



5.6.2. Dispositivo idraulico di frenatura in estensione (sospensione anteriore)

La regolazione deve essere effettuata partendo dalla posizione standard. Per trovare tale posizione, occorre ruotare in senso orario fino a fondo corsa, quindi in senso antiorario fino alla posizione standard (vedi tabella allegata). Ruotare in senso orario per aumentare l'azione frenante, oppure ruotare in senso antiorario per diminuirla.





5.6.3. Dispositivo idraulico di frenatura in compressione (sospensione anteriore)

La regolazione deve essere effettuata partendo dalla posizione standard. Per trovare tale posizione, occorre ruotare in senso orario fino a fondo corsa, quindi in senso antiorario fino alla posizione standard (vedi tabella allegata). Ruotare in senso orario per aumentare l'azione frenante, oppure ruotare in senso antiorario per diminuirla.

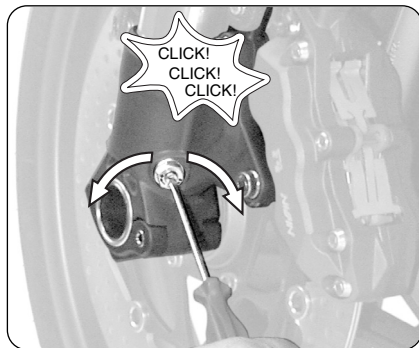



5.7. Regolazione sospensione posteriore



ATTENZIONE: l'alta temperatura dei tubi di scarico può provocare scottature. Spegner il motore ed attendere che i tubi di scarico si siano raffreddati prima di effettuare la regolazione.

NOTA: La regolazione delle sospensioni deve essere preferibilmente effettuata con il serbatoio carburante pieno.



Dispositivo idraulico di frenatura in compressione
(per alte e basse velocità)

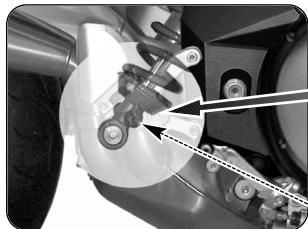

Dispositivo idraulico di frenatura in estensione



5



5.7.1. Dispositivo idraulico di frenatura in estensione (sospensione posteriore)

La regolazione deve essere effettuata agendo sulla vite presente nella parte inferiore dell'ammortizzatore e partendo dalla posizione standard.

Per trovare tale posizione, occorre ruotare in senso orario fino a fondo corsa, quindi in senso antiorario fino alla posizione standard (vedi tabella allegata).

Ruotare in senso orario per aumentare l'azione frenante, oppure ruotare in senso antiorario per diminuirla.

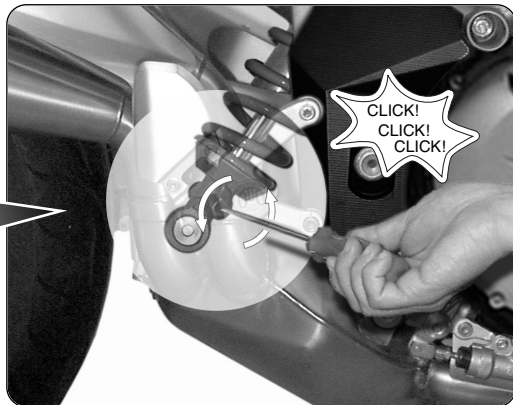
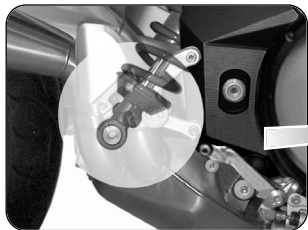



5.7.2. Dispositivo idraulico di frenatura in compressione per alte velocità (sospensione posteriore)

La regolazione deve essere effettuata agendo sulla ghiera presente nella parte superiore dell'ammortizzatore e partendo dalla posizione standard. Per trovare tale posizione, occorre ruotare in senso antiorario fino a fondo corsa, quindi in senso orario fino alla posizione standard (vedi tabella allegata). Ruotare in senso orario per aumentare l'azione frenante, oppure ruotare in senso antiorario per diminuirla.



5.7.3. Dispositivo idraulico di frenatura in compressione per basse velocità (sospensione posteriore)

La regolazione deve essere effettuata agendo sulla vite presente nella parte superiore dell'ammortizzatore e partendo dalla posizione standard. Per trovare tale posizione, occorre ruotare in senso orario fino a fondo corsa, quindi in senso antiorario fino alla posizione standard (vedi tabella allegata). Ruotare in senso orario per aumentare l'azione frenante, oppure ruotare in senso antiorario per diminuirla.





5.8. Regolazione proiettore anteriore

Porre il veicolo a 10 metri di distanza da una parete verticale.

Assicurarsi che il terreno sia piano e che l'asse ottico del proiettore sia perpendicolare alla parete.

Il veicolo deve trovarsi in posizione verticale. Misurare l'altezza del centro del proiettore da terra e riportare sulla parete una crocetta alla medesima altezza.

Accendendo la luce anabbagliante, il limite superiore di demarcazione tra la zona oscura e la zona illuminata deve risultare ad un'altezza non superiore a $9/10$ dell'altezza da terra del centro del proiettore.

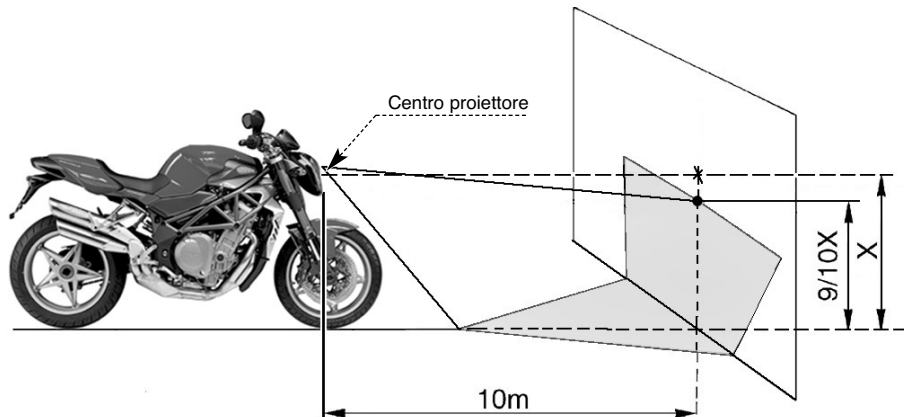



La regolazione del faro anteriore può essere effettuata agendo sulla vite raffigurata a lato. In senso orario: il faro si inclina verso il basso. In senso antiorario: il faro si inclina verso l'alto. L'inclinazione può essere variata di $\pm 4^\circ$ rispetto alla posizione standard.

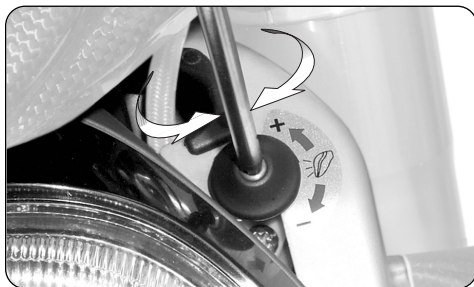
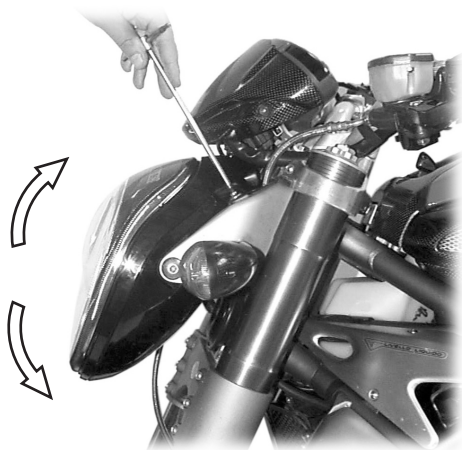

5



Nota informativa

MV Agusta S.p.A. è impegnata in una politica di continuo miglioramento dei propri prodotti; per questa ragione potrebbe essere possibile riscontrare leggere differenze tra quanto riportato nel presente documento ed il veicolo da Voi acquistato. I modelli MV Agusta vengono esportati in numerosi Paesi, nei quali valgono norme differenti in relazione al Codice della Strada ed alle procedure di omologazione. Contando sulla Vostra comprensione, MV Agusta S.p.A. ritiene quindi necessario riservarsi il diritto di apportare modifiche ai propri prodotti ed alla propria documentazione tecnica in qualsiasi momento e senza fornirne preavviso.

Vi consigliamo di visitare periodicamente il sito Internet www.mvagusta.it per ottenere informazioni ed aggiornamenti sui prodotti MV Agusta e sulla relativa documentazione.



Rispettiamo e difendiamo l'ambiente

Tutto ciò che facciamo ha ripercussioni sull'intero pianeta e sulle sue risorse.

MV Agusta, a tutela degli interessi della comunità, sensibilizza i Clienti e gli operatori dell'assistenza tecnica ad adottare modalità d'uso del mezzo e di smaltimento di sue parti, nel pieno rispetto delle normative vigenti in termini di inquinamento ambientale, smaltimento e riciclaggio dei rifiuti.

5

© 2006

È vietata la riproduzione anche parziale di questo documento senza il consenso scritto della MV Agusta S.p.A.

Part. n° 8000A9724

Edizione n° 1 - Ottobre 2006

MV AGUSTA

**910
BRUTALE**



User's manual
English Version

Dear Customer,

We wish to thank you for your preference and congratulate you on purchasing your new F4 Brutale 910 S. MV Agusta, thanks to the passionate effort of its technicians, offers to its customers a motorcycle with a new aesthetic design combined with a refined framework: these are the elements which have distinguished every vehicle created by MV Agusta throughout its glorious history.

The result of this effort is an exclusive motorcycle with functional and aesthetic characteristics that place it above the finest motorcycles currently available on the market, making it an exclusive and sought-after item.

In fact, the technologies and solutions applied give to the F4 Brutale 910 S unique characteristics common to all the MV Agusta models, strenghtening a design phylosophy that involves continuous research, technological innovation and love for detail. This way, MV Agusta gives to all the bikers who freely live their passion the chance to possess a unique object, which surely represents a strong reference worldwide.

For further information, please feel free to contact the MV Agusta Customer Care Service.

Have a good time!

*Claudio Castiglioni
MV Agusta
Chairman*



CONTENTS

<i>chap.</i>	<i>Subject covered</i>	<i>page</i>
1	GENERAL INFORMATION	5
1.1.	Purpose of the manual	5
1.2.	Symbols	6
1.3.	Contents of the CD-Rom	7
1.4.	Identification data	8
2	SAFETY INFORMATION	11
2.1.	Allowed use of the vehicle	11
2.2.	Maintenance	11
2.3.	Accessories and modifications	12
2.4.	Vehicle load	12
3	CONTROLS AND INSTRUMENTS	14
3.1.	Location of controls and instruments	14
3.2.	Sidestand	16
3.3.	Handlebar controls, left side	17
3.4.	Handlebar controls, right side	19
3.5.	Ignition switch and steering lock	22
3.6.	Gear lever	26
3.7.	Instruments and warning lights	27
3.7.1.	Warning lights	28
3.7.2.	Multifunction display	29
3.8.	Table of lubricants and fluids	30

<i>chap.</i>	<i>Subject covered</i>	<i>page</i>
4	OPERATION	31
4.1.	Using the motorcycle	31
4.2.	Running-in	32
4.3.	Starting the engine	34
4.4.	Selecting and setting the display functions	36
4.4.1.	Selecting the display functions	37
4.4.2.	Setting the measurement units	38
4.4.3.	Resetting the trip mileage counters	41
4.4.4.	Setting the clock	44
4.5.	Refuelling	46
4.6.	Glove compartment	48
4.7.	Parking the motorcycle	50
5	ADJUSTMENTS	52
5.1.	List of adjustments	52
5.2.	Table of adjustments	55
5.3.	Adjusting the front brake lever	56
5.4.	Adjusting the clutch lever	56
5.5.	Adjusting the rearview mirrors	57
5.6.	Adjusting the front suspension	58
5.6.1.	Spring preload	59



CONTENTS

<i>chap.</i>	<i>Subject covered</i>	<i>page</i>
5.6.2.	Rebound damper (front suspension)	59
5.6.3.	Compression damper (front suspension)	60
5.7.	Adjusting the rear suspension	61
5.7.1.	Rebound damper (rear suspension)	62
5.7.2.	High speed compression damper (rear suspension)	63
5.7.3.	Low speed compression damper (rear suspension)	63
5.8.	Headlight adjustment	64



1.1. Purpose of the manual

This User's Manual contains the necessary information for a correct and safe use of the motorcycle.

Together with this manual, a pocket Quick Manual is also supplied, in which the minimum essential informations for the use of the vehicle are reported.

The User's Manual is also supplied in electronic format (.pdf) on this CD-Rom and it can be printed or viewed on any PC, equipped either with Windows or Mac operative system.

We recommend to carefully read the User's Manual before using your motorcycle, and to make sure that anyone who uses the motorcycle had previously made the same.

Finally, we recommend to always take with you the Quick Manual, after having filled it in with your personal ID data and the specifications of your motorcycle.

1 GB



Copyright
MV AGUSTA Motor Spa
All rights reserved



1.2. Symbols

Sections of text that are particularly important in terms of personal safety or possible damage to the motorcycle are marked with the following symbols:



Danger - Failure to observe these prescriptions, even in part, may pose a serious hazard to the driver's and other people's safety.



Caution - Failure to observe these prescriptions, even in part, may result in damage to the motorcycle.

The following symbols give an indication of who is supposed to perform the different adjustments and/or maintenance operations:



Information on operations that can be carried out by the user.



Information on operations that must be carried out only by authorized personnel.

The following symbols are used to provide further information:



The “” symbol points out the requirement to use a tool or a special equipment in order to correctly perform the described operation.



The “§” symbol refers the reader to the chapter identified by the number that follows.



1.3. Contents of the CD-Rom

Inside this CD-Rom you will find, besides the User's Manual, the Maintenance Manual, the Quick Manual (which is also supplied in a paper copy), the World Dealer Guide and the Warranty Booklet.

When delivering the bike, your Dealer has also supplied the Warranty and Pre-Delivery Certificate.

We recommend to keep it together with the motorcycle documents and with the service coupons that are given at the moment of servicing the bike.

IMPORTANT

The copy of the Warranty and Pre-Delivery Certificate to be sent to MV Agusta must be filled in by the dealer and returned to the factory within 10 days from the date of registration.

The dealer must always fill in the service coupon and return it to MV Agusta within 10 days from the date of the servicing.

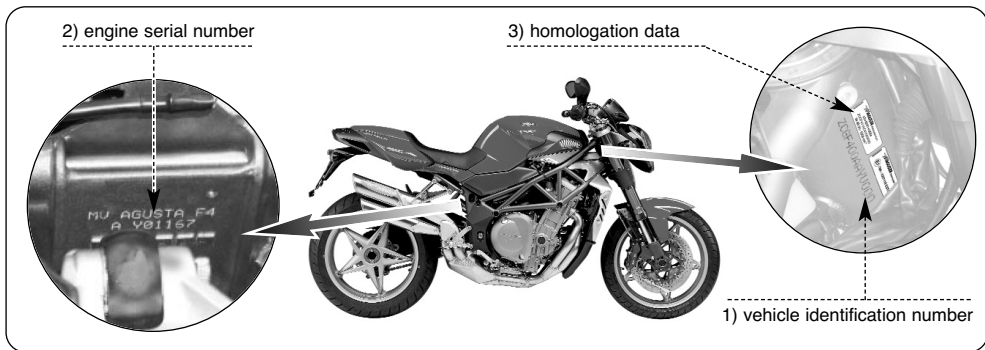

1.4. Identification data

- 1) vehicle identification number
- 2) engine serial number
- 3) homologation data

► Motorcycle identification

The motorcycle is identified by the vehicle identification number. When placing orders for spare parts, in addition to this number, you may be required to provide the engine serial number, the colour code and the key identification.

We recommend writing down the main numbers in the spaces provided below.

FRAME No.: _____

ENGINE No.: _____



► Motorcycle key identification

A key is supplied in duplicate for both the ignition and all the locks. Keep the duplicate in a safe place.

It is essential to provide the key identification number if you place an order for a spare motorcycle key. We recommend writing down this number in the space provided below:

KEY No.:

► Identification of motorcycle colour combination

The colour code must be mentioned when ordering body spares. It can be read on the lower left side of the fuel tank.

In order to get to the colour code label, it is necessary to remove the fuel tank left-hand side fairing. Pull out the rear part of the fuel tank left-hand side fairing as shown in the figure.

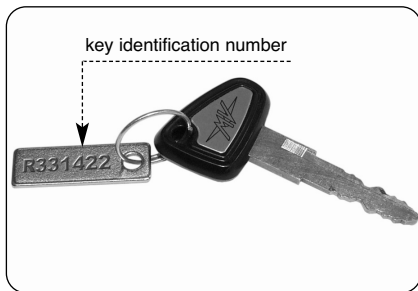

1 GB

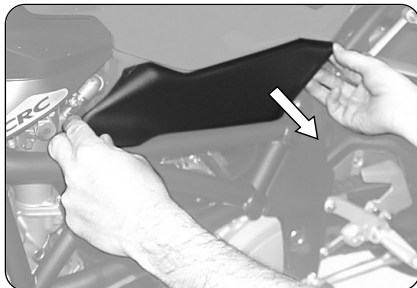



GB 1

Remove the fuel tank left-hand side fairing by pulling it towards the rear part of the motorcycle.

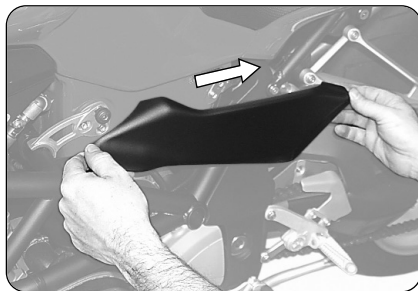

After removing the fuel tank left-hand side fairing, it is possible to get to the colour code label. On this label you can read the motorcycle colour combination, which determines the painting of the bodywork parts.

We recommend writing down the colour code in the space provided below:

COLOUR CODE :

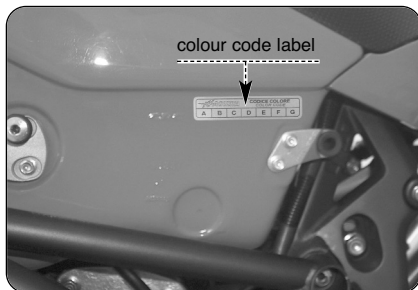



2.1. ALLOWED USE OF THE VEHICLE

Your motorcycle has been strictly designed for use on road or highway route.



WARNING

Occasionally, it is possible to use your motorcycle on race track during non-competitive events.

In this case, however, in consequence of the higher stresses affecting the bike during this specific use, we recommend to have its conditions checked by an authorized MV Agusta Service Center before and after using it.

Any other use of the vehicle is prohibited and explicitly excluded.

You can find further information about the use of the vehicle in the section no. 4 of this Manual.

2.2. MAINTENANCE

In order to guarantee the maximum efficiency and reliability of the vehicle, it is necessary to perform the programmed maintenance operations reported in the Maintenance Manual.

MV Agusta recommends that all maintenance operations are performed only by skilled personnel from an authorized MV Agusta Service Center. Anyway, if you decide to have the maintenance operations performed by non-authorized workshops, you must ensure that they have the skills and the specific tools necessary to perform the above operations.



WARNING

The MV Agusta Warranty could not be valid if non-authorized workshops had performed operations on the bike in a different way from what is described on the Technical Circular Letters and on the related MV Agusta Workshop Manuals.



2.3. ACCESSORIES AND MODIFICATIONS



WARNING

MV Agusta prohibits to make any modification to its motorcycles.

This is necessary to preserve the safety of its Customers.

Anyway, it is possible to customize your motorcycle by consulting the extensive MV Agusta Accessory Catalogue.



WARNING

The installation of some of the above accessories could invalidate the bike homologation, and consequently make the bike not furtherly usable on public roads.

If you have doubts, we suggest to refer to your MV Agusta Dealer in order to choose the accessories which can better suit your needs.

2.4. VEHICLE LOAD

Your motorcycle is designed for use by the rider and it can also seat a passenger.

To use the vehicle in complete safety and in accordance with the Highway Code provisions, it is compulsory that the following maximum load conditions are never exceeded:

BRUTALE 910 S

Maximum total weight	370 kg
Maximum load weight	180 kg

The maximum total weight comes out from the sum of the following weights, according to the European standard CEE 92/61:

- weight of the motorcycle;
- weight of the driver;
- weight of the passenger;
- weight of the load and all the accessories.

**WARNING**

Since the load can strongly affect handling, braking, performance and safety characteristics of your motorcycle, you should always keep in mind the following warnings.

- **NEVER OVERLOAD YOUR MOTORCYCLE!** Driving an overloaded motorcycle can cause damage to the tyres, loss of control of the vehicle and serious injury. Verify that the total weight (including the weight of the motorcycle, the driver, the passenger, the load and all the accessories) does not exceed the maximum value specified for your vehicle.



3.1. Location of controls and instruments

GB
3

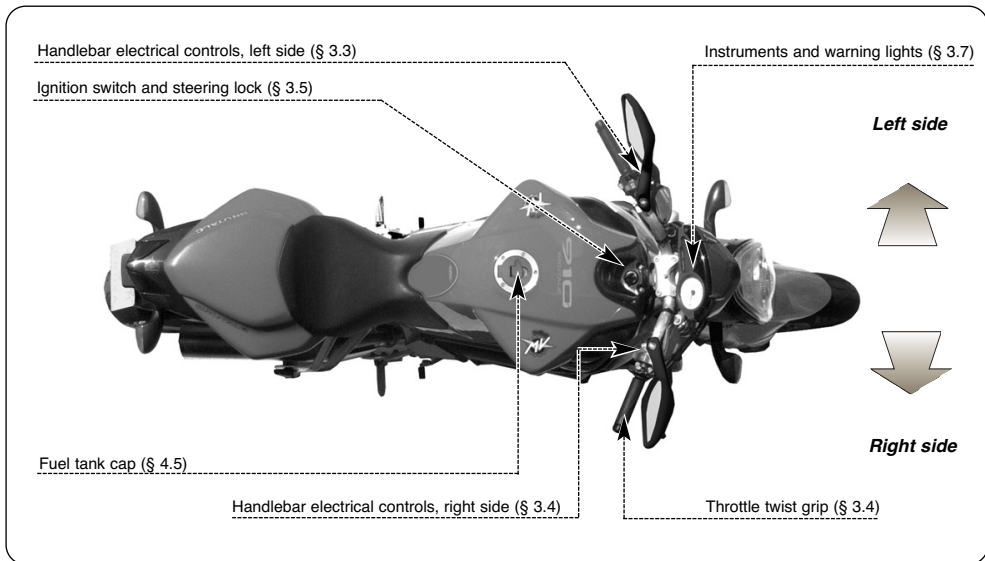

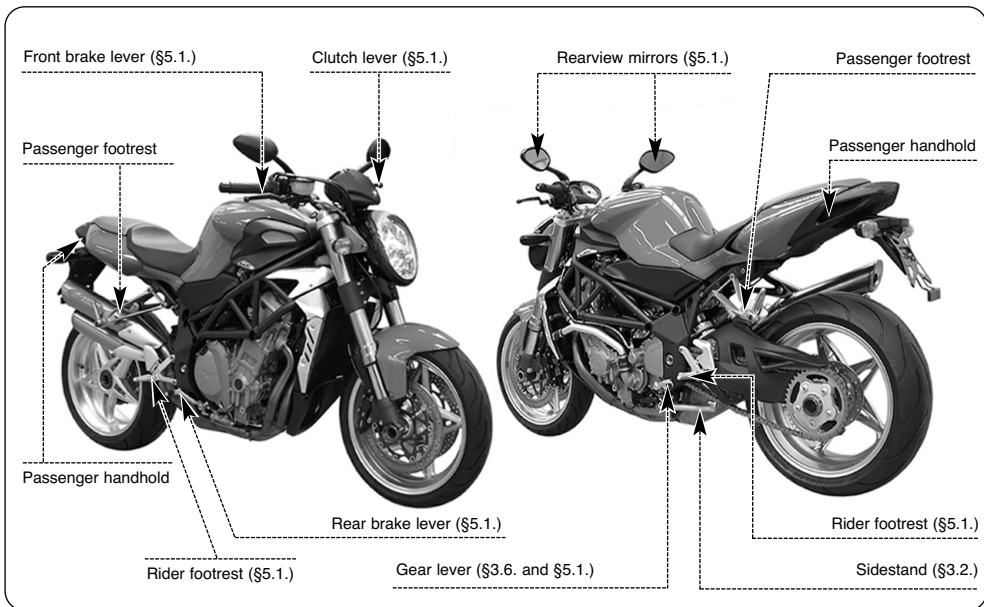

3 GB



3.2. Sidestand

The sidestand is equipped with a safety switch that prevents the motorcycle from moving off while the stand is down.

If the rider attempts to engage the gears while the engine is running and the stand is down, the switch automatically turns off the engine by cutting the current supply.

If the motorcycle is parked (sidestand down) and the gears are engaged, the switch prevents the engine from being started, thereby avoiding the risk of accidentally toppling the vehicle.

GB
3





3.3. Handlebar controls, left side

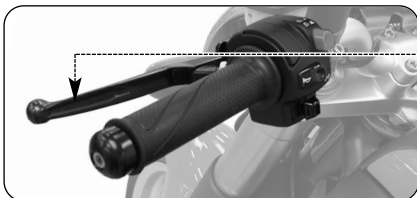

Clutch lever

Move towards/away from the handgrip to release/engage the clutch.

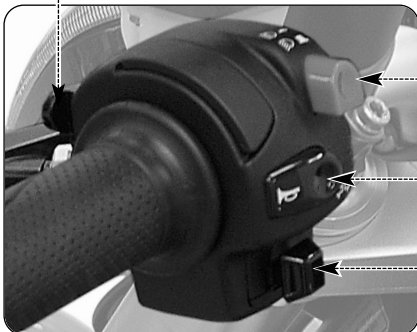

High beam flasher button

Press the button repeatedly.

Low/high beam button

Button not pressed in  : low beam

Button pressed in  : high beam

Horn button

Press to operate the warning horn.

Turn indicator switch

Shifting the lever to the left or right switches on the left or right turn indicators. The switch then returns to the central position. Press to turn off the indicators.

**High beam flasher button**

It is used to attract the attention of other road users in case of danger. When the high beam is on, the function is inactive.

Low/high beam button

Under normal conditions, the low beam is on. The high beam can be switched on by pressing the button when allowed by the traffic and road conditions.

Turn indicator switch

It is used to show the rider's intention to change direction or lane.

**WARNING**

Failure to switch the turn indicators on or off at the right time may cause an accident in that the other road users may draw incorrect conclusions about the direction of motion of the vehicle. Always switch on the indicators before turning or changing lanes. Then be sure to switch off the indicators after completing the operation.

Horn button

It is used to attract the attention of other road users in case of danger.

Clutch lever

It engages/disengages the clutch through a hydraulically controlled device.



3.4. Handlebar controls, right side

Front brake lever

Pull to the lever to apply the front brake.

Throttle twist grip

Rotate counterclockwise to increase engine speed.

Cold start (choke) lever

Rotate clockwise when cold starting. After the engine has run for a few seconds, return the lever to its original position.

Engine stop switch

Stops the engine and prevents it from being restarted.

Engine start button

Starts the engine. To be released as soon as the engine starts. When the engine is running, pressing the button selects the display functions.

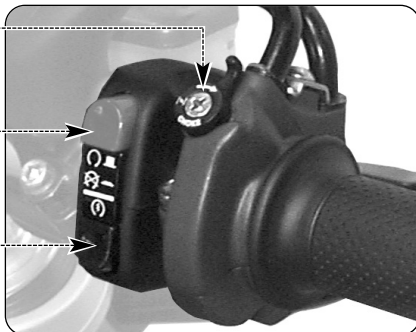
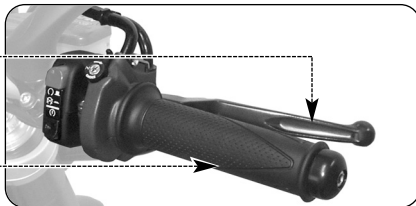

**Engine stop switch**

It is used to switch off the engine in an emergency. The ignition circuit is disabled, preventing the engine from being restarted. To be able to restart the engine, return the switch to its original position.

NOTE

Under normal conditions, do not use this switch to shut off the engine.

CB 3**Engine start button**

It is used to start the engine and, when the engine is running, to select the different functions of the display installed on the instrument panel.

**CAUTION**

To avoid damaging the electrical equipment, be sure not to hold down the button for longer than 5 consecutive seconds.

If, after some attempts, the engine does not start, refer to the chapter “TROUBLESHOOTING” later in this manual.

Cold start (choke) lever

It facilitates cold starting by slightly enriching the fuel-air mixture during start-up.

NOTE

This function must remain active only for a short time depending on the engine and environmental temperature. As soon as the idle speed keeps the engine running, it is advisable to disable the control.

**Throttle twist grip**

It controls the fuel-air mixture supplied to the engine, which regulates engine speed. To increase engine speed, rotate the hand grip from its idle position counterclockwise.

When cold starting (choke on), rotating the throttle twist grip clockwise fully and repeatedly causes the choke lever to return to its original position.

Front brake lever

It controls a hydraulic circuit that operates the front wheel braking system.



3.5. Ignition switch and steering lock



WARNING

Do not attach a ring or any other object to the ignition key as they may hinder the steering action.



WARNING

Never attempt to change the switch functions while riding, as you may lose control of the vehicle.

GB 3

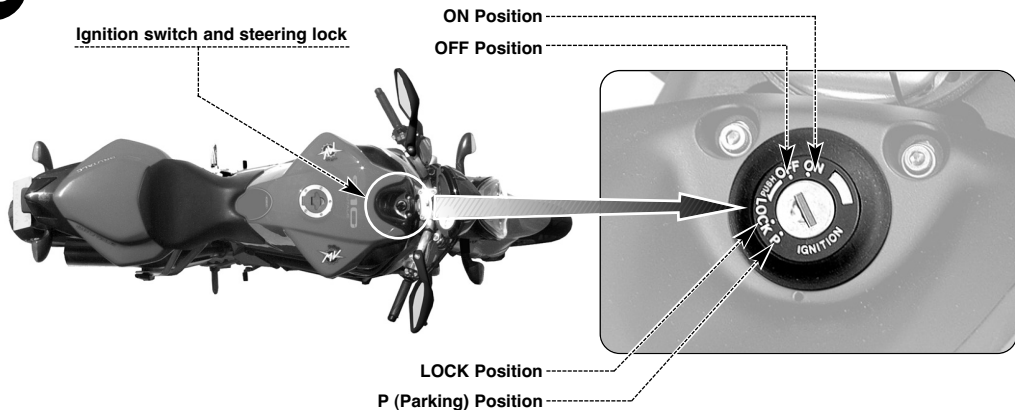



The ignition switch enables and disables the electrical circuit and the steering lock. The four positions of the switch are described below.

OFF position

All electrical circuits are deactivated. The key can be removed.



ON position

All electrical circuits are activated. The instruments and warning lights perform the self-diagnostic cycle. The engine can be started. The key cannot be removed.

**3 GB**

CAUTION: Do not leave the key on the ON position for a long time when the engine is not running, in order to avoid damage to the electrical parts of the motorcycle.



LOCK position

Turn the handlebar to the left. Press the key in gently while rotating it to the LOCK position. All electrical circuits are deactivated and the steering is locked. The key can be removed.

GB
3

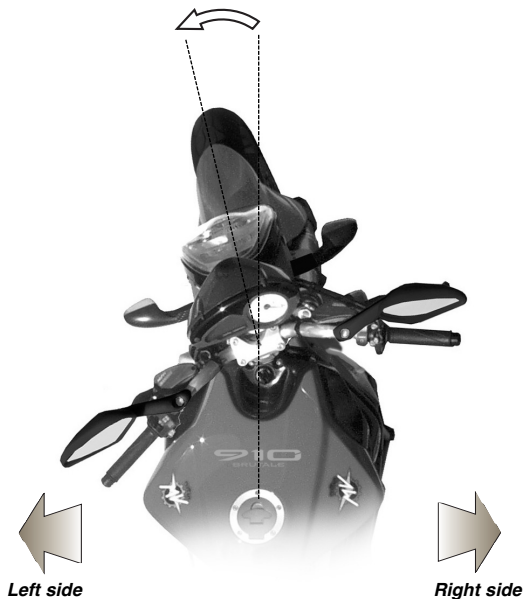



P (PARKING) position

Turn the key from the LOCK position to the P position. All electrical circuits are deactivated except the parking lights. The steering is locked. The key can be removed.



CAUTION

Do not leave the key on the P position for a long time, in order to avoid discharging the battery of your motorcycle.





3.6. Gear lever

The **N** (neutral) position is indicated by the warning light on the instrument panel.

To change into first gear, push the lever down.

To change into second gear, lift the lever up. Lifting the lever up repeatedly engages all the other gears in succession up to the sixth speed.

GB
3



Gear lever

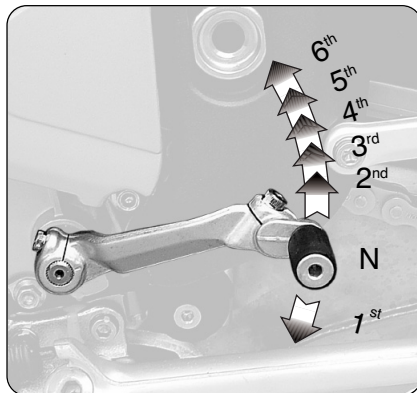



3.7. Instruments and warning lights

The instruments and warning lights are activated by turning the ignition switch to the ON position. After a preliminary check (approx. 7 seconds) the displayed information reflects the current general condition of the motorcycle.

Warning lights

(§3.7.1.)

SET button (§3.7.2.)

Multifunction display (§3.7.2.)

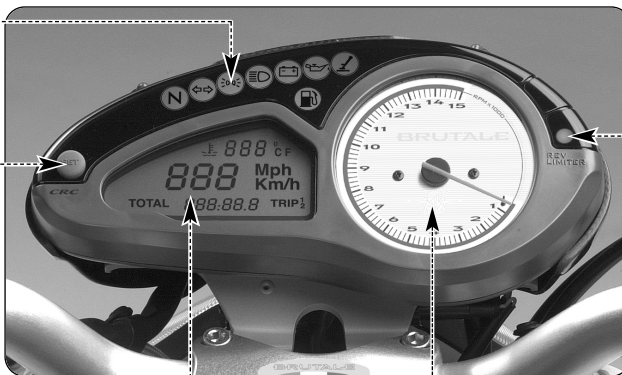

Warning light
(§3.7.1.)

Tachometer



3.7.1. Warning lights

High beam warning light (blue)

Lights up when the high beam is activated.

Low beam warning light (green)

Comes on when the low beam is activated.

Neutral indicator (green)

Lights up when the gears are in neutral.

Turn indicator light (green)

Lights up when the turn indicators are activated.

Reserve fuel indicator (amber)

Comes on when approximately 4 litres of fuel are left.

Battery charge indicator (red)

Lights up when the alternator does not supply enough current to charge the battery.

If the indicator comes on while riding, contact an authorized service centre.

Sidestand down warning light (red)

Lights up when the sidestand is down.

Rev limiter warning light (red)

Lights up when the engine speed exceeds 11,300 rpm. The rev limiter limits the rpm to 12,000.

Engine oil pressure warning light (red)

Lights up when the oil pressure is insufficient.



WARNING: If the warning light comes on while riding, stop the motorcycle immediately. Check the oil level and if necessary have it restored by a MV Agusta authorized service centre (see §3.8.). If the warning light comes on even if the oil level is correct, do not resume riding and contact a MV Agusta authorized service centre.

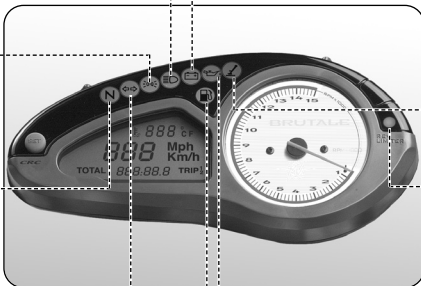



3.7.2. Multifunction display

Speedometer

Measures the speed of the vehicle. The speed can be displayed in kilometres per hour (km/h) or miles per hour (mph). The full-scale value is 299 km/h (186 mph).

SET button

Pressing the button allows the setting of the different display functions. Pressing the button again confirms the entered values.

TOTAL mileage counter

Displays the total distance covered: from 0 to 99,999.9 (km or mi)

TRIP 1 mileage counter

Displays a first trip mileage count: from 0 to 9,999.9 (km or mi)

TRIP 2 mileage counter

Displays a second trip mileage count: from 0 to 9,999.9 (km or mi)

Clock

Displays the time (0÷24)

Thermometer

Displays the coolant temperature in degrees centigrade (°C) or Fahrenheit (°F).

The display range is 40° to 140° C (104° to 284° F):

- Below 40° C (104° F) no temperature is displayed but three blinking lines denote a very low temperature.

- Between 40° and 49° C (104° and 120° F) the temperature reading blinks to indicate a low temperature.

- Between 50° and 111° C (122° and 232° F) the temperature reading is fixed.

- Between 112° and 140° C (234° and 284° F) the temperature reading blinks to indicate a high temperature.

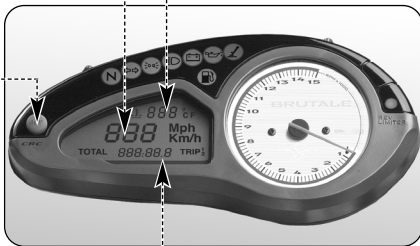

WARNING: If the temperature exceeds 120° C (248° F), stop the motorcycle immediately and check the coolant level. If the coolant level is low, have it topped up by a MV Agusta authorized service centre (see § 3.8.). If the high temperature indication is given even when the coolant level is correct, do not resume riding and contact a MV Agusta authorized service centre.

**3.8. Table of lubricants and fluids**

<i>Description</i>	<i>Recommended product</i>	<i>Specifications</i>
Engine lubrication oil	AGIP RACING 4T 10W/60 (*)	SAE 10W/60 - API SJ
Coolant	AGIP ECO - PERMANENT	Ethylene glycol diluted with 50 percent distilled water
Brake and clutch fluid	AGIP BRAKE FLUID DOT4	DOT4
Drive chain lubrication oil	MOTUL CHAIN LUBE ROAD	-

* : MV Agusta suggests to refer directly to its authorized dealers in order to purchase the recommended product. The AGIP Racing 4T 10W/60 engine oil has been expressly produced for the F4 motorcycle engine. If the above described lubricant is not available, MV Agusta suggests to use a fully synthetic engine oil having characteristics equal or better than the ones prescribed in the following standards:

- Consistent with: API SJ
- Consistent with: ACEA A3
- Consistent with: JASO MA
- SAE Rating: SAE 20 W-50 or 10 W-60

NOTE

The above standard denominations must be written, alone or together, on the engine oil container label.





4.1. Using the motorcycle

This section provides the basic information needed to correctly operate the motorcycle.

**WARNING**

The F4 BRUTALE 910 S motorcycle shows high power and performance characteristics; therefore, its use requires an adequate level of knowledge of the vehicle. When you use this motorcycle for the first time, it is essential to adopt a cautious attitude. An aggressive or reckless riding attitude can lead to accidents, compromising the driver's and other people's safety.

**WARNING**

THE RESTRICTIONS RELATED TO THE ALLOWED USE OF THE VEHICLE ARE DESCRIBED IN THE SECTION "SAFETY INFORMATIONS".



4.2 Running-in



CAUTION

Failure to observe the indications provided below can reduce performance and shorten the life of the motorcycle.

Running-in is generally considered to apply only to the engine. In fact, it should be regarded as an essential phase for other important parts such as the tyres, the brakes and the drive chain. During the very first miles, adopt a relaxed riding style.

□ 0 to 500 km (0 to 300 mi) (A)

Frequently change the engine speed. If possible, prefer hilly routes with gentle slopes and many bends. Avoid long straight stretches.

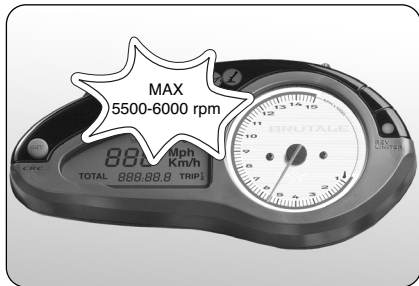

WARNING

New tyres must undergo a proper running-in period to reach their complete efficiency. Avoid abrupt acceleration, turning and braking during the first 100 km. Failure to observe these prescriptions can lead to the sliding of the wheels and the loss of control of the vehicle with subsequent risk of accidents.



□ 500 to 1000 km (300 to 600 mi)

Avoid lugging or overspeeding the engine, and vary your speed frequently.

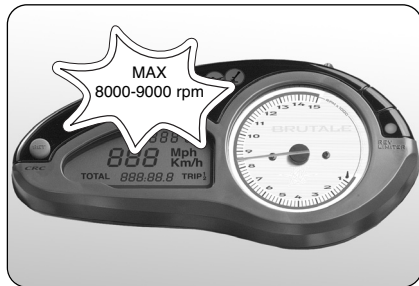

4 CB

□ 1000 to 2500 km (600 to 1600 mi)

Higher engine performance can be demanded, but it is advisable not to exceed the engine speed shown in the figure.

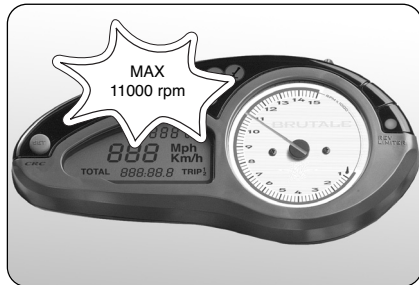



4.3. Starting the engine



WARNING

Starting the engine in a closed place can be dangerous. Exhaust emissions contain carbon monoxide, a colourless and odourless gas that can lead to serious harm or even death when inhaled.

Only start the engine outdoor, in the open air.

► As you turn the ignition switch to the ON position, the instruments and the warning lights will go through the self-diagnostic cycle; during this phase, make sure that all the warning lights on the dashboard come on. One of the following conditions must be verified, in order that the ignition switch system allows engine starting:

- The gears are in neutral.
- The gears are engaged, the clutch lever is pulled and the side stand is up.

❑ Cold starting

► Rotate the CHOKE lever without turning the throttle twist grip and then press the start button.





▶ As soon as the engine starts, release the button and, after warming up the engine for a short time, return the CHOKE lever to its original position.

☐ Hot starting

- ▶ Press the start button without turning the throttle twist grip.
- ▶ As soon as the engine starts, release the button.



CAUTION

- Do not press the start button for longer than 5 consecutive seconds, in order to avoid damage to the electrical equipment.
- Avoid warming up the engine while the vehicle is stationary. The subsequent engine overheating can cause damage to the internal parts of the engine. It is advisable to bring the engine to the working temperature by riding at reduced speed.
- To ensure the maximum life of the engine, never speed up at full throttle when the engine is cold.





4.4. Selecting and setting the display functions

The display functions allow to change some of the main measuring parameters.

The possible operations are listed as follows:

- Selecting the functions:

TOTAL	Mileage	Counter
TRIP 1	Mileage	Counter
TRIP 2	Mileage	Counter
Clock		

- Setting the following measurement units:

Speed
Mileage
Temperature

- Resetting the trip mileage counters:

TRIP 1	Mileage	Counter
TRIP 2	Mileage	Counter

- Setting the clock.





4.4.1. Selecting the display functions

You can select the following functions:

- TOTAL Mileage Counter
- TRIP 1 Mileage Counter
- TRIP 2 Mileage Counter
- Clock

► The TOTAL, TRIP 1 and TRIP 2 functions can be displayed by pressing the engine start button. Pressing the button repeatedly cycles through the different functions. Select the desired function.

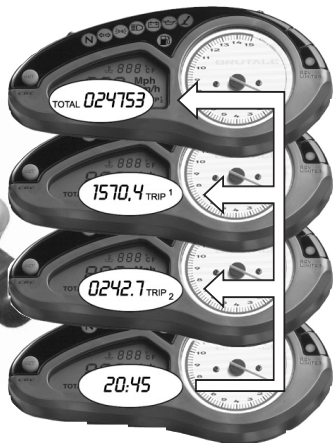

4 GB



WARNING

The operation must be performed while the engine is running, the gears are in neutral, the motorcycle is stationary, and with the feet on the ground. Do not set the display functions while riding as it may cause loss of control of the vehicle.



4.4.2. Setting the measurement units

It is possible to set the measurement units of the displayed quantities.



WARNING

The operation must be performed while the engine is running, the gears are in neutral, the motorcycle is stationary, and with the feet on the ground. Do not set the display functions while riding as it may cause loss of control of the vehicle.



□ Speedometer (Km/h - Mph)

- ▶ Repeatedly press the engine start button until the TOTAL mileage counter is displayed.
- ▶ Press the SET button; the speedometer unit starts blinking.





OPERATION

4

► Press the engine start button to toggle between Km/h and Mph. Changing the speedometer unit also changes the units for the total and trip mileage counters.

Remember that: 1 mi = 1,609 Km

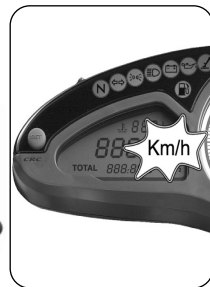

4 CB

► Press the SET button to confirm the speedometer unit. The thermometer unit will start blinking, indicating that the display is ready for the next setting.





□ Thermometer (° C - ° F)

- ▶ Press the engine start button to toggle between ° C and ° F.

Remember that: $T (^{\circ}\text{F}) = 1.8 \cdot t (^{\circ}\text{C}) + 32$

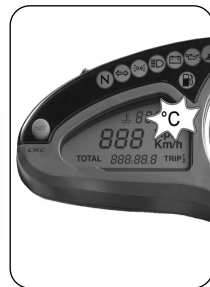

- ▶ Press SET to confirm the temperature unit.





4.4.3. Resetting the trip mileage counters

The TRIP 1 and TRIP 2 counters can be reset as follows:



WARNING

The operation must be performed while the engine is running, the gears are in neutral, the motorcycle is stationary, and with the feet on the ground. Do not set the display functions while riding as it may cause loss of control of the vehicle.

- ▶ Select the TRIP 1 function by pressing the engine start button.
- ▶ Press the button for longer than four seconds. The TRIP 1 mileage will start blinking.

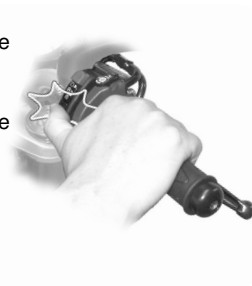



► Pressing the button for less than four seconds sets the mileage to zero. If, on the other hand, the button is pressed for longer than four seconds the entire resetting procedure is cancelled.



GB
4

► Select the TRIP 2 function by pressing the engine start button.





- ▶ Press the engine start button for longer than four seconds; the TRIP 2 mileage will start blinking.



- ▶ Pressing the button for less than four seconds sets the mileage to zero. If, on the other hand, the button is pressed for longer than four seconds the entire resetting procedure is cancelled.

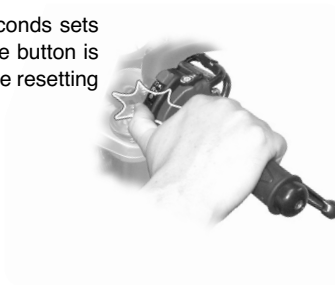



4.4.4. Setting the clock

It is possible to set the clock function.



WARNING

The operation must be performed while the engine is running, the gears are in neutral, the motorcycle is stationary, and with the feet on the ground. Do not set the display functions while riding as it may cause loss of control of the vehicle.



- ▶ Repeatedly press the engine start button until the time is displayed.
- ▶ Press the SET button – the first hour digit will start blinking.





- ▶ Hold down the engine start button and release it as soon as the desired figure is displayed.

NOTE

To quickly cycle through the selected digit, hold the start button depressed for longer than two seconds.

- ▶ Press SET to confirm the first hour digit and to be able to set the following digit.
- ▶ Repeat the procedure to set the second hour digit and the first and second minute digits.
- ▶ Press SET to confirm the time and exit the set (blinking) mode.

NOTE

The instrument panel has an integrated memory which retains all the parameters even when the engine is not running. Except for the clock, which is reset, all the parameters are retained even when the battery is disconnected.



4 GB

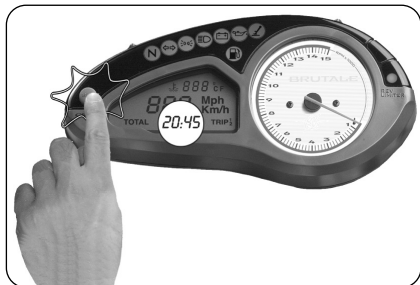



4.5. Refuelling



WARNING

Petrol and its fumes are highly toxic and flammable. Avoid contact and inhalation. When refuelling, switch off the engine, avoid smoking, and keep away from flames, sparks and heat sources. Perform refuelling in the open air or in a well ventilated area.



CAUTION

Only use unleaded fuel with a R.O.N. octane rating of 95 or higher. The green dot on the lower side of the tank cap serves as a reminder of this.

- ▶ Lift the dust cover.
- ▶ Insert the key into the lock and rotate it clockwise.

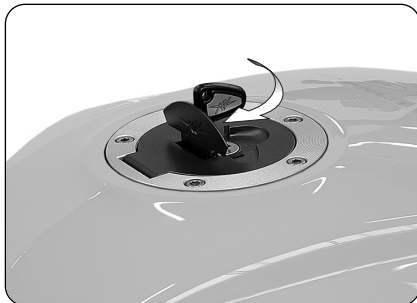
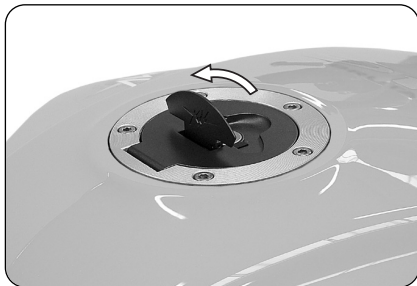



- ▶ Lift the tank cap and operate the refuelling.

**WARNING**

Overfilling the tank may cause the fuel to overflow as a result of the expansion due to the heat from the engine or to exposure to sunlight. Fuel spills can catch fire. The level of the fuel in the tank must never be higher than the base of the filler.

- ▶ After refuelling, press down the tank cap while rotating the key clockwise to facilitate the locking. Then release the key and remove it.

**CAUTION**

Immediately wipe the overflowed fuel with a clean cloth, to avoid damage to the painted or plastic surfaces.

**WARNING**

Verify that the tank filler cap is correctly closed before using the motorcycle.

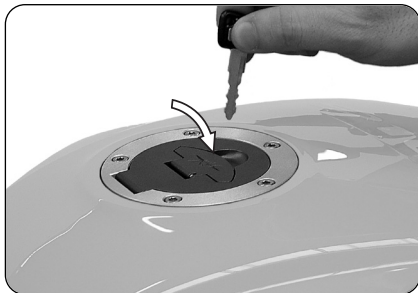
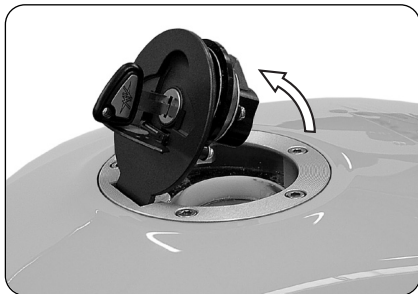
4
CB

**4.6. Glove compartment**

► Insert the key into the lock.

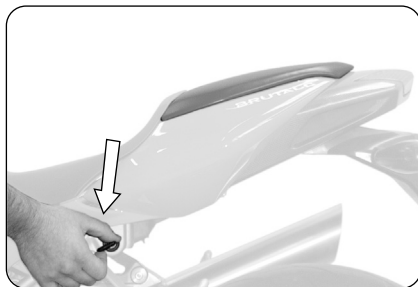

► Press down the pillion while turning the key clockwise. Lift the pillion.





- Remove the pillion.

In order to reassemble the above mentioned part, you must perform the following operations:

- Rotate the key into the lock
- Press down the pillion
- Release the key
- Press down the pillion once more, so to make sure of its firm coupling to the frame.



4 CB

**WARNING**

Every time you lift or remove the pillion and every time the vehicle is used, make sure that the above mentioned part is correctly placed and that it is firmly secured to the motorcycle framework.



4.7. Parking the motorcycle

□ Using the sidestand



CAUTION

Park the motorcycle safely on solid ground. On slopes, engage the first gear and park the vehicle so that the front wheel faces uphill. Remember to put the gear lever in the neutral position before restarting the engine. Never leave the vehicle unattended while the engine key is in the dashboard.

- ▶ Using your foot, lower the sidestand as far as it will go, and then slowly tip the motorcycle toward you to bring the stand supporting foot into contact with the ground's surface.

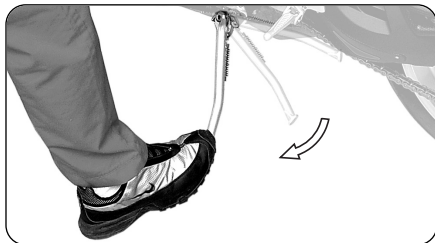

Do not sit on the vehicle when it is parked on the sidestand, as your full weight would rest on the vehicle's only support. Before riding off, ensure that the sidestand warning light on the instrument panel goes out. In any case, make sure that the stand has been retracted. If you notice a malfunction of the side stand switch, have it controlled by your MV Agusta dealer before using the motorcycle.



□ Using the rear stand

Insert the stand pin into the rear wheel axle hole on the left side of the motorcycle. Rest the stand on the ground and, pressing down on the stand, lift the vehicle until it reaches a stable condition.



CAUTION

This operation is best carried out with two people, one to steady the motorcycle and one to manipulate the rear stand.

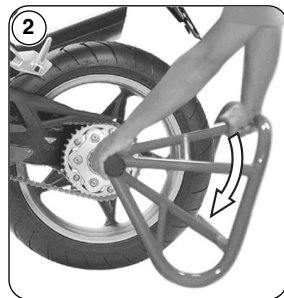
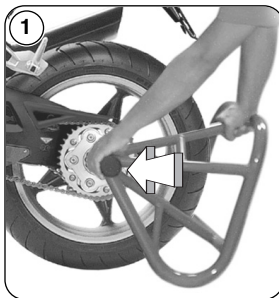



5.1. List of adjustments

There are many adjustments that can significantly improve the ergonomics, geometry and safety of the motorcycle.

However, since an incorrect adjustment of particularly important components can lead to dangerous situations, some of the above adjustments must be performed only by authorized MV Agusta Service Centers.



WARNING

All adjustments must be performed when the vehicle is stationary.



ADJUSTMENTS

5

(F) Rearview mirror adjustment (§5.5.)

(A) Front brake lever adjustment (§5.3.)

(C) Right-hand footrest adjustment (§5.2.)

(H) Rear suspension adjustment (§5.7.)

(E) Rear brake lever adjustment (§5.2.)

(G) Front suspension adjustment (§5.6.)

(M) Headlight adjustment (§5.8.)

(G) Front suspension adjustment (§5.6.)

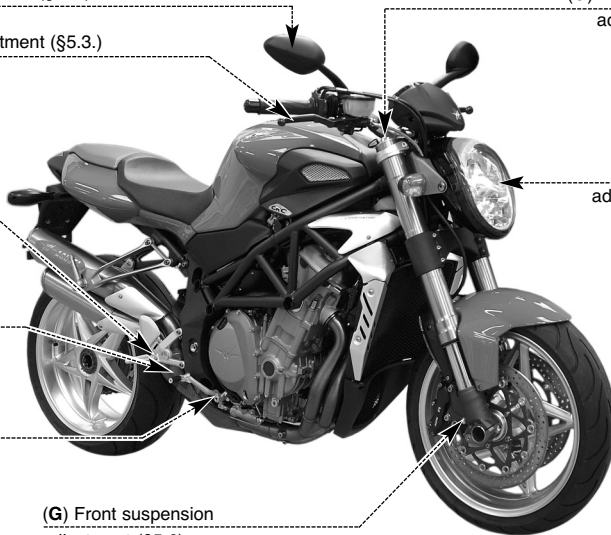

5 GB



(F) Rearview mirror adjustment (§5.5.)

(H) Rear suspension adjustment (§5.7.)

(B) Clutch lever adjustment (§5.4.)

(D) Gear lever adjustment (§5.2.)

(C) Left-hand footrest adjustment (§5.2.)

(L) Drive chain adjustment (§5.2.)





5.2. List of adjustments



A - Front brake lever adjustment: Optimizes the grip to suit the rider's needs (§5.3).



B - Clutch lever adjustment: Optimizes the grip to suit the rider's needs (§5.4).



C - LH and RH footrest adjustment: Optimizes the position of the feet to suit the rider's needs.



D - Gear lever adjustment: Optimizes the position of the lever to suit the rider's needs.



E - Rear brake lever adjustment: Optimizes the position of the lever to suit the rider's needs.



F - Rearview mirror adjustment: Optimizes the orientation of the rearview mirrors (§5.5).



WARNING: Do not operate the screw fixing the rearview mirror to the handlebar. If this screw needs to be tightened, contact your MV Agusta dealer.



G - Front suspension adjustment: The following can be adjusted to adapt the response of the suspension to the rider's preference:

- spring preload (§5.6.1.)
- rebound damper (§5.6.2.)
- compression damper (§5.6.3.)



H - Rear suspension adjustment: The following can be adjusted to adapt the response of the suspension to the rider's preference:

- spring preload
- geometry height



- rebound damper (§5.7.1.)
- high speed compression damper (§5.7.2.)
- low speed compression damper (§5.7.3.)



L - Drive chain adjustment: To ensure safe and effective transmission of power.



M - Headlight adjustment: To adjust the range of the light beam to the geometry of the motorcycle (§5.8).



5.3. Adjusting the front brake lever

While pulling the lever to counter the action of the spring, turn the ring clockwise or counterclockwise to move the lever away or towards the handgrip respectively.

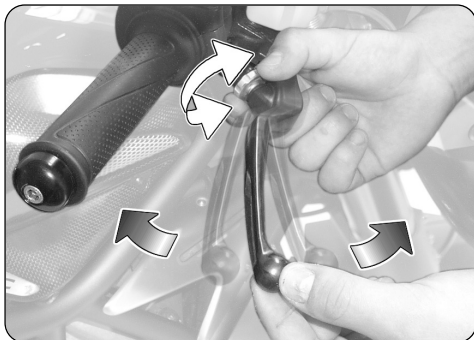

5.4. Adjusting the clutch lever

While pulling the lever to counter the action of the spring, turn the ring clockwise or counterclockwise to move the lever away or towards the handgrip respectively.





5.5. Adjusting the rearview mirrors

Press the mirror at the points shown in the figure to adjust its position in the four directions.

Perform the adjustment on both the rearview mirrors. It is recommended to sit on the vehicle in order to optimize the rearview mirrors adjustment.

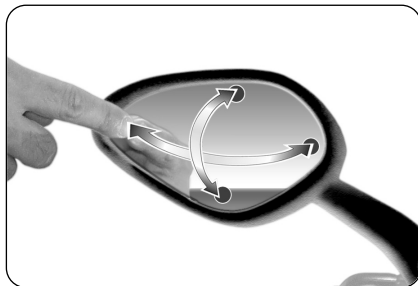

5 GB



5.6. Adjusting the front suspension



WARNING: It is essential that the adjusters of both fork rods are adjusted to the same position.

NOTE: The adjustment of the suspensions must be preferably performed with the fuel tank full.

Rebound damper

Spring preload

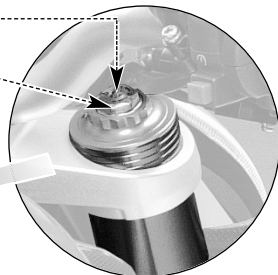

Compression damper

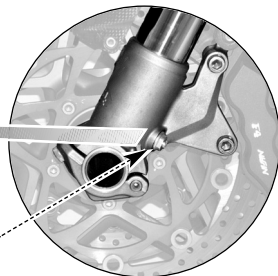



5.6.1. Spring preload

The adjustment is obtained from the standard position, which is found by fully turning the adjusting nut counterclockwise and then clockwise (see enclosed table). Rotate clockwise to increase the spring preload or counterclockwise to decrease it.



5.6.2. Rebound damper (front suspension)

The adjustment is obtained from the standard position, which is found by fully turning the screw clockwise and then counterclockwise (see enclosed table). Rotate clockwise to increase the damping action or counterclockwise to decrease it.





5.6.3. Compression damper (front suspension)

The adjustment is obtained from the standard position, which is found by fully turning the screw clockwise and then counterclockwise (see enclosed table). Rotate clockwise to increase the damping action or counterclockwise to decrease it.

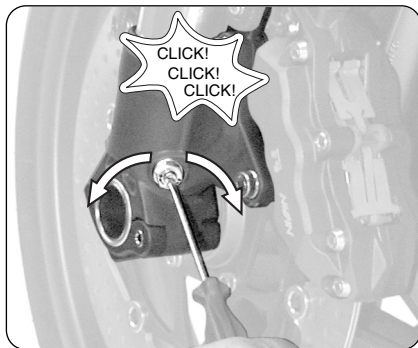



5.7. Adjusting the rear suspension



WARNING: The high temperature of the exhaust pipes can cause burns. Before adjusting the rear suspension, shut off the engine and wait until the exhaust pipes have thoroughly cooled.

NOTE

The adjustment of the suspensions must be preferably performed with the fuel tank full.

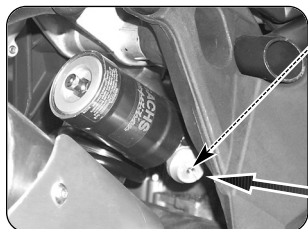

High and Low speed
compression damper

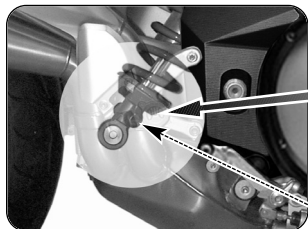

Rebound damper



5 GB



5.7.1. Rebound damper (rear suspension)

The adjustment can be performed by operating on the screw placed on the lower side of the shock absorber, and it is obtained from the standard position.

This position is found by fully rotating the ring clockwise and then counterclockwise (see enclosed table). Rotate clockwise to increase the damping action or counterclockwise to decrease it.

GB
5

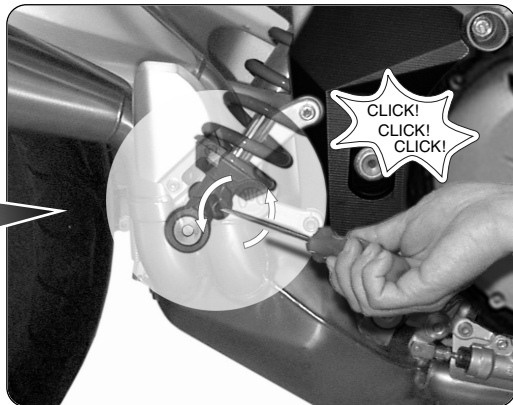
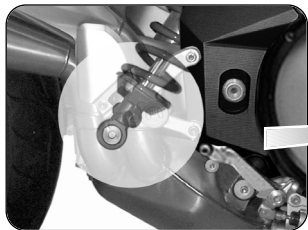



5.7.2. High speed compression damper (rear suspension)

The adjustment can be performed by operating on the ring nut placed on the upper side of the shock absorber, and it is obtained from the standard position. This position is found by fully rotating the ring nut counterclockwise and then clockwise (see enclosed table). Rotate clockwise to increase the damping action or counterclockwise to decrease it.



5.7.3. Low speed compression damper (rear suspension)

The adjustment can be performed by operating on the screw placed on the upper side of the shock absorber, and it is obtained from the standard position. This position is found by fully rotating the screw clockwise and then counterclockwise (see enclosed table). Rotate clockwise to increase the damping action or counterclockwise to decrease it.





5.8. Headlight adjustment

Place the vehicle at a distance of 10 m from a vertical wall.

Make sure that the motorcycle is placed on an even horizontal surface, and that the headlight's optical axis is perpendicular to the wall.

The vehicle must be held in an upright position. Measure the "X" distance between the headlight center and the ground surface, then trace a small cross on the wall at the same height.

When you turn the headlight on, the upper boundary line between the dark area and the lighted area must be at an height equal or lower than the 9/10 of the headlight center height (X).

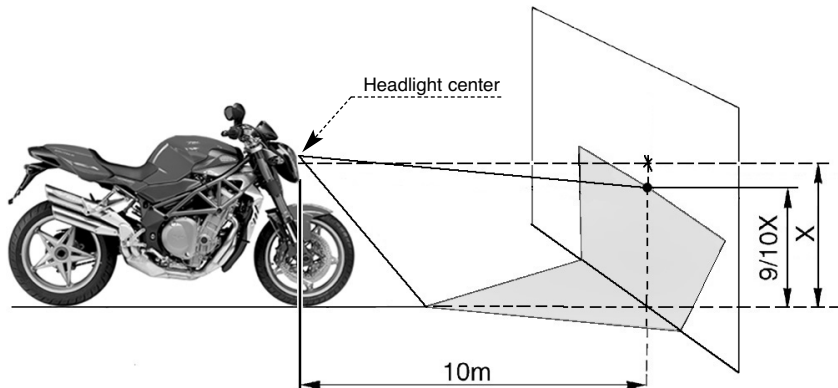



The headlight adjustment can be performed by rotating the screw shown in the picture. Rotate clockwise to incline the headlight downwards, counterclockwise to incline it upwards. The possible adjustment range is equal to $\pm 4^\circ$ from the standard position.

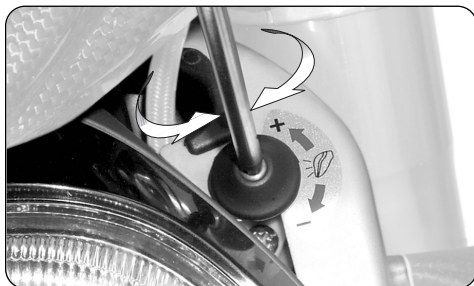
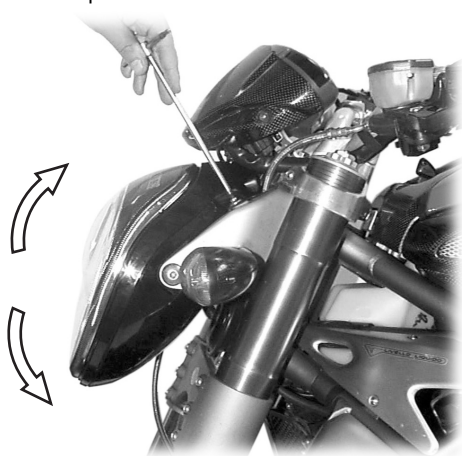

5 GB



Information

MV Agusta S.p.A. is committed to a policy of constant improvement; therefore, you may find slight differences between the information provided in this document and the vehicle you purchased. MV Agusta motorcycles are exported in several countries, in which different rules and regulations (concerning both the Highway Code and the homologation procedures) are in force. Relying on your understanding, MV Agusta S.p.A. deems it necessary to reserve the right to change its products and the related documentation at any time and without notice.

We suggest to often visit the Internet site **www.mvagusta.it** in order to obtain informations and updates about the MV Agusta products and the related documentation.



Respect and defend natural environment

Everything we do affects the whole planet as well as its resources.

MV Agusta, in order to protect the interests of the community, awakens the Customers and the Technical Assistance operators to use the vehicle and dispose of its replaced parts respecting the laws in force concerning environmental pollution and waste disposal and recycling.

MV AGUSTA

**910
BRUTALE**



Manuel d'utilisation
Version Française

Cher client,

Nous vous remercions de la confiance que vous nous accordez et vous félicitons pour votre nouvelle F4 Brutale 910 S.

Grâce à la passion et aux efforts de ses techniciens, MV Agusta présente aujourd'hui aux amateurs un produit à l'esthétique inédite associée à une partie cycle raffinée. Ces éléments, qui ont caractérisé toutes les créations de la maison MV Agusta tout au long de sa glorieuse histoire.

Le résultat est une moto exclusive qui se place, de par ses caractéristiques esthétiques et fonctionnelles et ses innombrables innovations techniques, au plus haut niveau que le marché motocycliste puisse offrir à l'heure actuelle.

Les solutions qui ont été mises en place confère à la F4 Brutale 910 S ce caractère unique qui la rapproche des autres modèles de la famille MV Agusta tout en consolidant une philosophie de conception qui privilégie un effort constant de recherche, l'innovation technologique et l'amour pour le détail et en donnant la possibilité à tous ceux qui vivent leur passion pour la moto en pleine liberté de posséder un objet unique au monde qui s'impose avec fermeté sur la place mondiale.

Si vous désirez plus d'information, n'hésitez pas à contacter notre Service Après-Vente MV Agusta.

Bon divertissement

*Claudio Castiglioni
Président
MV Agusta*



TABLE DES MATIÈRES

<i>Chap.</i>	<i>Sujets abordés</i>	<i>page</i>	<i>Chap.</i>	<i>Sujets abordés</i>	<i>page</i>
1	GÉNÉRALITÉS	5	4	UTILISATION	31
1.1.	Utilité de ce livret	5	4.1.	Utilisation de la moto	31
1.2.	Symboles	6	4.2.	Rodage	32
1.3.	Contenu du CD-Rom	7	4.3.	Démarrage	34
1.4.	Données d'identification	8	4.4.	Sélection et modification des fonctions d'affichage	36
2	INFORMATIONS SUR LA SÉCURITÉ	11	4.4.1.	Sélection des fonctions d'affichage	37
2.1.	Utilisation admise du véhicule	11	4.4.2.	Réglage de l'unité de mesure	38
2.2.	Entretien	11	4.4.3.	Mise à zéro des compteurs kilométriques partiels	41
2.3.	Accessoires et modifications	12	4.4.4.	Réglage de la fonction horloge	44
2.4.	Chargement du véhicule	12	4.5.	Approvisionnement en carburant	46
3	COMMANDES ET APPAREILS	14	4.6.	Accès à la boîte à gants	48
3.1.	Position des commandes et appareils	14	4.7.	Stationnement de la moto	50
3.2.	Béquille latérale	16	5	RÉGLAGES	52
3.3.	Commandes au guidon côté gauche	17	5.1.	Liste des réglages	52
3.4.	Commandes au guidon côté droit	19	5.2.	Tableau des réglages	55
3.5.	Contacteur principal et verrouillage de direction	22	5.3.	Réglage du levier de frein avant	56
3.6.	Sélecteur de vitesses	26	5.4.	Réglage du levier d'embrayage	56
3.7.	Appareils et voyants	27	5.5.	Réglage des rétroviseurs	57
3.7.1.	Voyants lumineux	28	5.6.	Réglage de la suspension avant	58
3.7.2.	Affichage multifonctions	29	5.6.1.	Précharge du ressort	59
3.8.	Tableau des lubrifiants et liquides	30			



TABLE DES MATIÈRES

<i>Chap.</i>	<i>Sujets abordés</i>	<i>page</i>
5.6.2.	Dispositif hydraulique de freinage en détente (suspension avant)	59
5.6.3.	Dispositif hydraulique de freinage en compression (suspension avant)	60
5.7.	Réglage de la suspension arrière	61
5.7.1.	Dispositif hydraulique de freinage en détente (suspension arrière)	62
5.7.2.	Dispositif hydraulique de freinage en compression pour vitesse élevée (suspension arrière)	63
5.7.3.	Dispositif hydraulique de freinage en compression pour vitesse basse (suspension arrière)	63
5.8.	Réglage du projecteur avant	64



1.1. Utilité de ce livret

Le présent Manuel fournit les informations nécessaires pour une utilisation correcte et sûre de la moto.

Est également fourni un Manuel Rapide de poche contenant les informations essentielles pour l'utilisation du véhicule.

Le Manuel est fourni aussi sous format électronique (.pdf) sur le présent CD-ROM et peut être imprimé ou affiché sur tout PC avec système Windows ou Mac.

Nous vous recommandons de lire attentivement le Manuel avant d'utiliser la moto et de vous assurer que toutes les personnes utilisant la moto ont lu attentivement le Manuel.

Nous vous conseillons de toujours avoir sur vous le Manuel Rapide avec vos données d'identification et celles de la moto.



Copyright
MV AGUSTA Motor Spa
Tous droits réservés



1.2. Symboles

Les parties du texte particulièrement importantes qui concernent la sécurité de la personne et l'intégrité de la moto, sont mises en évidences par les pictogrammes suivants:



Danger - Attention: le non respect partiel ou total de ces prescriptions peut être source de danger pour soi-même et pour autrui.



Prudence - Précautions: le non respect partiel ou total de ces prescriptions peut être cause de dommages pour la moto.

Pour indiquer les personnes autorisées à exécuter les opérations de réglage et/ou d'entretien, celles-ci sont mises en évidences par les pictogrammes suivants:



Informations sur les opérations permises au motard.



Informations sur les opérations qui doivent être effectuées uniquement par le personnel autorisé.

Pour mettre en évidence les informations supplémentaires, les symboles suivants sont utilisés:



Le symbole  indique la nécessité d'utiliser un outil ou un appareil spécial pour l'exécution correcte de l'opération décrite.



Le symbole "§" renvoie au chapitre correspondant au numéro qui l'accompagne.



1.3. Contenu du CD-Rom

Le présent CD-ROM contient en sus du présent Manuel le Manuel d'Entretien, le Manuel Rapide (est également fournie une version imprimée), le Guide des Concessionnaires et le Livret de Garantie.

Au moment de vous remettre la moto, votre Concessionnaire vous a remis le Certificat de Garantie et de Préparation à la route.

Nous vous invitons à conserver le Certificat avec les documents de la moto et les coupons qui vous seront remis à toutes les opérations de révision prévues par la garantie.

IMPORTANT

La copie du Certificat de Garantie et de Préparation à la route destinée à MV Agusta doit être remplie par le Concessionnaire et retournée à l'usine dans un délai de 10 jours après la date d'immatriculation.

Les copies des coupons de révision doivent toujours être remplies par le concessionnaire et retournées à MV Agusta dans un délai de 10 jours après la date d'exécution des interventions.



1.4. Données d'identification

- 1) numéro de série du cadre
- 2) numéro de série du moteur
- 3) données d'homologation

► Identification de la moto

La moto est identifiable grâce au numéro de série du cadre. Pour les commandes de pièces détachées, il peut être nécessaire d'indiquer également le numéro de série du moteur, le code couleur et le numéro d'identification des clés.

Il est conseillé de noter les données principales dans les espaces ci-dessous:

CADRE N.: _____

MOTEUR N.: _____



► Identification des clés de la moto

Une clé est fournie en double exemplaire, elle sert pour le contacteur de démarrage et pour toutes les autres serrures. Garder le double en lieu sûr.

Il est indispensable de connaître le numéro d'identification de la clé pour en demander un double.

Il est conseillé de noter le numéro d'identification dans l'espace suivant:

CLÉ N.:

► Identification de la combinaison de couleur de la moto

Le code couleur est indispensable pour la commande de pièces détachées de la carrosserie. On peut lire ce code sur la plaque qui se trouve sur la partie gauche inférieure du réservoir d'essence.

Pour accéder à la plaque du code couleur, il faut enlever le flanc réservoir gauche.

Retirez la partie arrière du flanc réservoir gauche comme représenté sur la figure.



1 FR

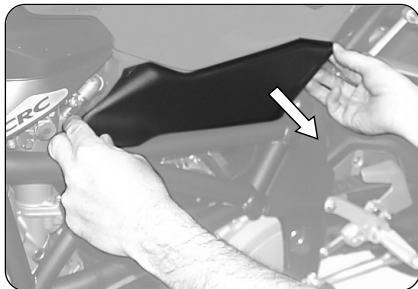



FR 1

Enlevez le flanc réservoir gauche en le tirant vers la partie arrière de la moto.

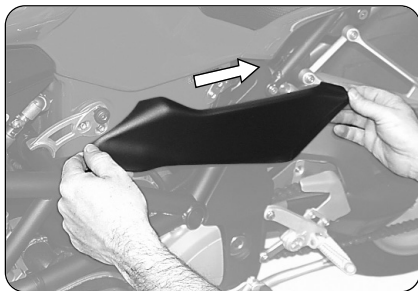

Après avoir enlevé le flanc réservoir gauche, on peut lire la plaque du code couleur. Cette plaque porte la mention du code couleur de la moto qui détermine la couleur des parties de la carrosserie.

Il est conseillé de noter le numéro d'identification du code couleur de la moto dans l'espace suivant:

CODE COULEUR:

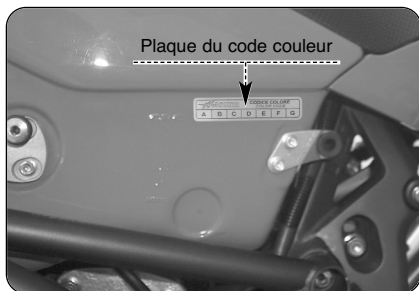



2.1. UTILISATION ADMISE DU VÉHICULE

La moto a été conçue pour une utilisation sur route et autoroute.



ATTENTION

Il est possible d'utiliser occasionnellement la moto sur piste mais pas dans le cadre de compétitions.

En raison des contraintes supplémentaires auxquelles est alors soumise la moto, nous vous recommandons de faire contrôler par un Centre d'Assistance MV Agusta les conditions de la moto avant et après l'emploi.

Toute autre utilisation est interdite et expressément exclue.

Vous trouverez d'autres informations sur l'utilisation de la moto dans la section 4 du présent Manuel.

2.2. ENTRETIEN

Pour garantir l'efficacité et la fiabilité maximum du véhicule, il est indispensable d'effectuer les opérations d'entretien indiquées dans le Manuel d'Entretien.

MV Agusta insiste sur le fait que toutes les opérations d'entretien doivent être effectuées uniquement par un personnel qualifié appartenant à un Centre d'Assistance MV Agusta.

Si toutefois vous décidez de faire exécuter les interventions d'entretien par des ateliers non agréés, nous vous conseillons de vous assurer qu'ils disposent des instruments spécifiques nécessaires à de telles opérations.



ATTENTION

La garantie MV Agusta pourrait ne pas être valable si les ateliers non agréés ont effectué des interventions sur la moto de manière incorrecte et non prévue par les Circulaires Techniques et les Manuels d'Atelier MV Agusta.



2.3. ACCESSOIRES ET MODIFICATIONS



ATTENTION

Pour garantir la sécurité de ses Clients, MV Agusta interdit toute modification aux motos.

Toutefois, vous pouvez personnaliser votre moto en utilisant les Accessoires MV Agusta.



ATTENTION

L'installation de quelques-uns de ces accessoires peut annuler l'homologation de la moto et entraîner la non-utilisation sur route publique.

Dans le doute, nous vous invitons à contacter votre Concessionnaire de confiance pour identifier les accessoires les plus appropriés à vos exigences.

2.4. CHARGEMENT DU VÉHICULE

Le véhicule a été conçu pour être utilisé par un pilote et le cas échéant un passager. Pour l'utiliser en toute sécurité et dans le respect des dispositions du code de la route, il est obligatoire de ne jamais dépasser le poids lourd total maximum admis dont le valeur est indiquée ci-dessous.

BRUTALE 910 S

Poids total maximum	370 kg
Poids de charge maximum	180 kg

Le poids total maximum est la somme des poids suivants, conformément à la directive CEE 92/61:

- poids de la moto;
- poids du pilote;
- poids du passager;
- poids de la charge et des accessoires.

**ATTENTION**

Etant donné que le chargement a un impact énorme sur la maniabilité le freinage, les performances et les caractéristiques de sécurité de votre moyen de transport, prenez toujours les précautions suivantes.

- **NE SURCHARGEZ JAMAIS LE MOTOCYCLE !** L'utilisation d'une moto surchargée peut provoquer des dégâts aux pneumatiques, des pertes de contrôle ou des accidents graves. Vérifiez que le poids total du pilote, du passager, du chargement et des accessoires ne dépasse pas la charge maximum indiquée pour la moto.



3.1. Position des commandes et appareils

FR 3

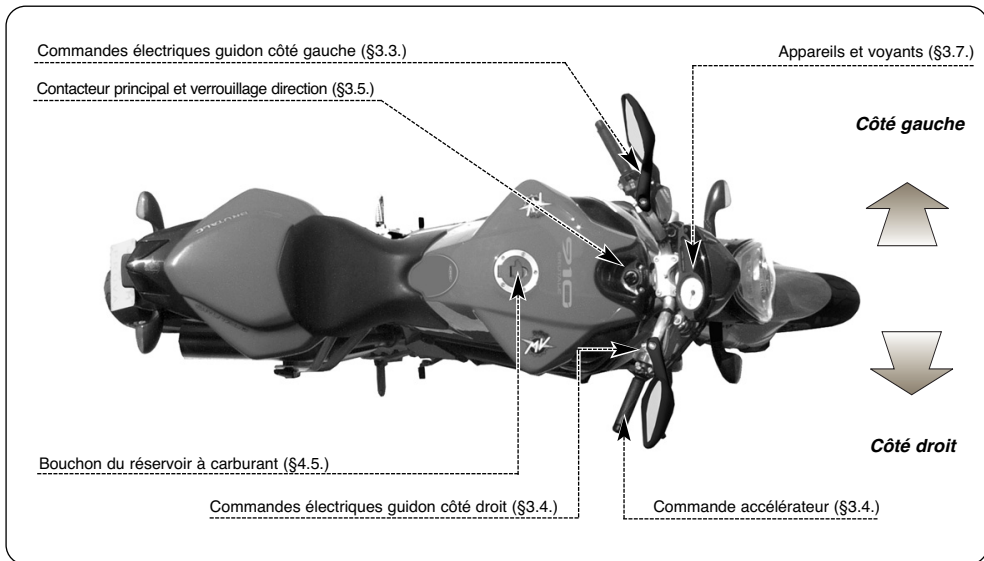

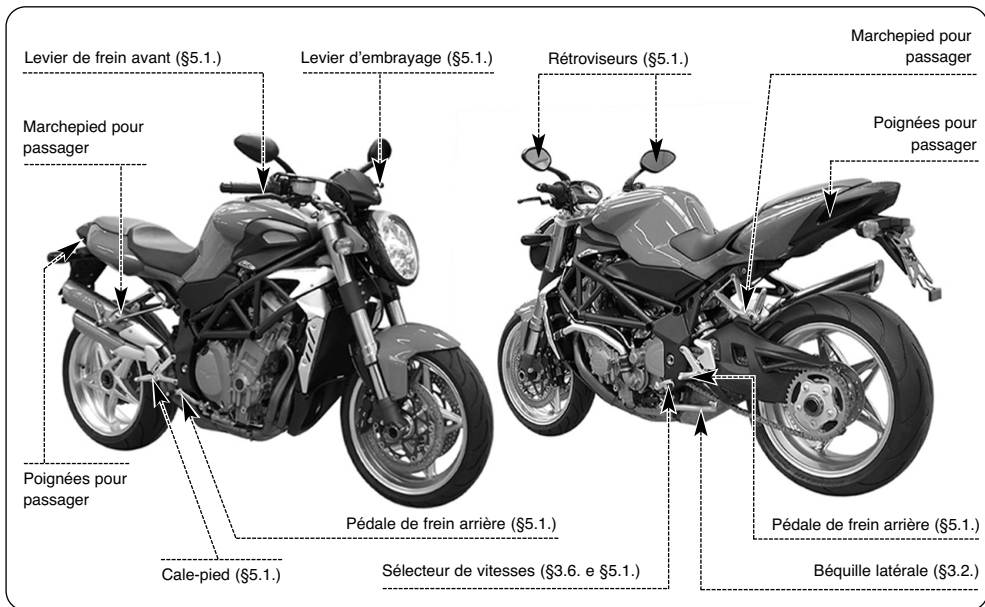



3.2. Béquille latérale

La béquille latérale est équipée d'un contacteur qui empêche à la moto de démarrer avec la béquille baissée.

Si le sélecteur de vitesses est actionné pour mettre la moto en mouvement lorsque le moteur tourne avec la béquille abaissée, le contacteur coupe le courant au moteur et provoque son arrêt.

Dans le cas où la moto se trouve en condition de stationnement (béquille baissée) avec un rapport engagé, le contacteur empêche le démarrage du moteur pour éviter tout risque de chute accidentelle.

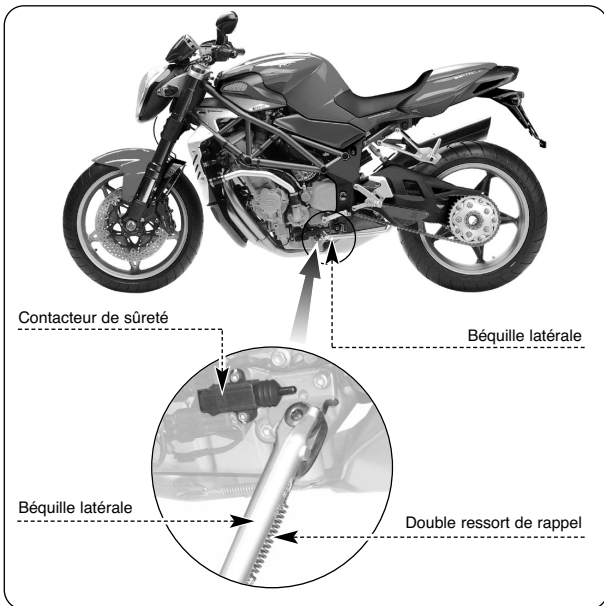



3.3. Commandes au guidon côté gauche

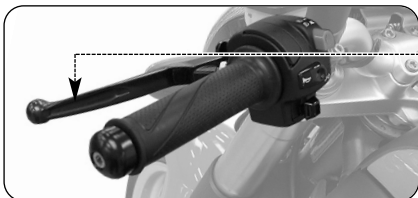

Lever d'embrayage

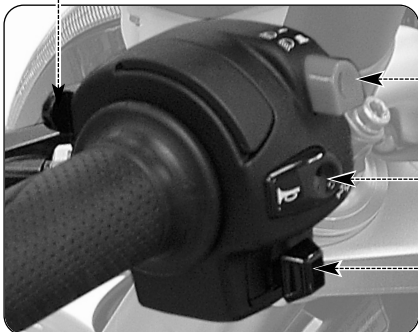

Tirer ou relâcher la poignée pour débrayer ou embrayer.





Bouton de clignotement des phares

Appuyer sur le bouton à répétition.

Inverseur code/phare

Bouton sorti  : feu de croisement 

Bouton enfoncé  : feu de route 

Bouton de l'avertisseur sonore

Appuyer pour utiliser l'avertisseur.

Poussoir de clignotants

En le déplaçant vers la droite ou la gauche on allume les clignotants correspondants. Le poussoir revient au centre, appuyer dessus pour éteindre les clignotants.



Bouton d'appel de phare

Cette fonction sert pour rappeler l'attention des autres usagers de la route en présence d'une situation dangereuse. Avec le feu de route éclairé, cette fonction est désactivée.

Bouton Inverseur code/phare

C'est normalement la fonction code qui s'allume. Lorsque les de trafic et de route le permettent, il est possible d'allumer le feu de route en agissant sur l'inverseur.

Levier des clignotants

Cette fonction permet de signaler aux autres usagers de la route, l'intention de changer de direction ou de voie de circulation.



ATTENTION

Si les clignotants ne sont pas utilisés ou coupés au moment opportun, il peut y avoir un risque d'accidents. En effet, les autres conducteurs pourraient tirer des conclusions erronées concernant la trajectoire du véhicule. Actionnez toujours les clignotants avant de tourner ou de changer de voie. Veillez à les couper dès que la manoeuvre est terminée.

Bouton de klaxon

Cette fonction sert pour attirer l'attention des autres usagers en cas de situations éventuelles de danger.

Levier d'embrayage

Ce levier, à travers un dispositif à contrôle hydraulique, permet de débrayer et d'embrayer.



3.4. Commandes au guidon côté droit

Levier de frein avant

Tirer vers la poignée pour actionner le frein avant.

Commande d'accélérateur

Tourner pour régler l'alimentation du moteur.

Levier de démarrage à froid du moteur (Choke)

Tourner dans le sens des aiguilles d'un montre pour les démarrages à froid. Au bout de quelques secondes, le ramener dans sa position initiale.

Coupe-circuit

Coupe le moteur et empêche le démarrage.

Bouton du démarreur

Actionne le démarreur. Dès que le moteur part, il faut le relâcher. Une fois le moteur en marche, il sert pour sélectionner les fonctions d'affichage.

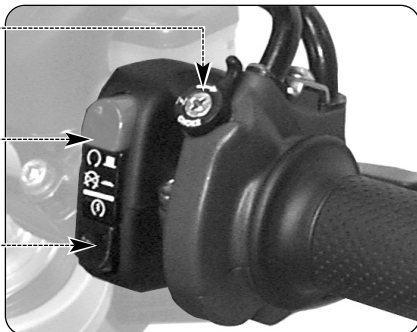
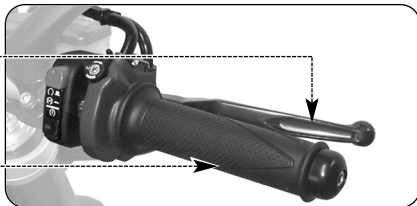



Coupe-circuit moteur

Cette fonction permet d'éteindre le moteur en cas d'urgence. De cette manière, le circuit d'allumage est coupé empêchant le redémarrage du moteur. Pour pouvoir démarrer, ramener le bouton en position de repos.

NOTE

En conditions normales, n'utilisez pas ce dispositif pour couper le moteur.

Bouton de démarrage moteur

Ce dispositif permet le démarrage du moteur. De plus, une fois le moteur démarré, il permet de sélectionner les fonctions de l'affichage du tableau de bord.



RAPPEL

Pour éviter des dommages à l'installation électrique, ne tenez pas le bouton enfoncé plus de 5 secondes consécutives.

Si le moteur ne démarre après plusieurs tentatives, consultez le chapitre "PANNES" du livret.

Levier de démarrage à froid du moteur (Choke)

Le dispositif facilite le démarrage à froid en agissant sur l'alimentation.

NOTE

Cette fonction ne doit être maintenue actionnée que pour un temps limité et dans tous les cas dépendant de la température du moteur ainsi que de l'environnement. Lorsque le régime de ralenti est suffisant pour faire tourner le moteur sans qu'il s'éteigne, ramener la commande de démarrage à froid en position de repos.



Commande d'accélérateur

Ce dispositif permet d'agir sur l'alimentation du moteur pour varier son régime de rotation. Pour actionner le dispositif, il faut faire pivoter la poignée à partir de la position de repos qui correspond au régime de ralenti moteur.

En condition de démarrage à froid (Choke actionné), la répétée rotation de la poignée dans le sens de fermeture des gaz permet de ramener le levier de Choke en position de repos.

Levier frein avant

Cette commande provoque l'actionnement par l'intermédiaire d'un circuit hydraulique du système de freinage de la roue avant.



3.5. Contacteur principal et verrouillage de direction



ATTENTION: Ne pas appliquer de porte-clés ou autre à la clé de contact pour ne pas risquer de gêner la rotation de la direction.



ATTENTION: Ne jamais chercher à changer certaines fonctions du contacteur en cours de route sous peine de perdre le contrôle du véhicule.

FR 3

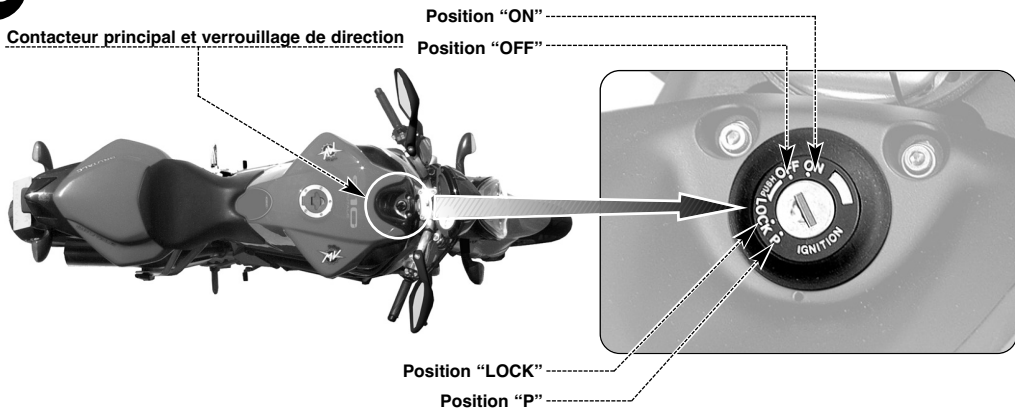



Le contacteur à clé branche et coupe le circuit électrique et le verrouillage de la direction; les quatre positions de commande sont décrites à la suite.

Position "OFF"

Tous les circuits électriques sont coupés. La clé peut être retirée.



Position "ON"

Tous les circuits électriques sont branchés, les appareils et les voyants effectuent l'auto-diagnostic; le moteur peut démarrer. La clé peut être retirée.



Rappel-Précautions: Ne pas laisser la clé sur la position "ON" à moteur éteint pendant trop longtemps sous peine d'endommager les composants électriques de la moto.



Position "LOCK"

Braquer le guidon à droite ou à gauche. Pousser légèrement sur la clé et la tourner simultanément en position "LOCK".

Tous les circuits sont coupés et la direction est verrouillée. La clé peut être retirée.

FR 3

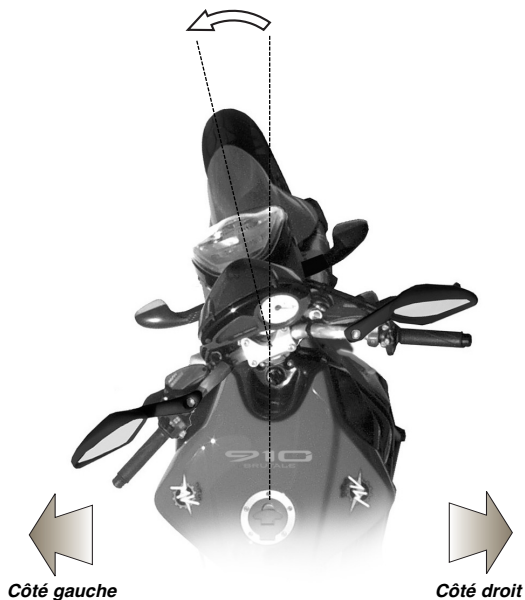



Position "P"

Tourner la clé de la position "LOCK" à la position "P".

Tous les circuits électriques sont coupés à l'exception des feux de stationnement (feux de positions) et la direction est verrouillée.

La clé peut être retirée.



RAPPEL

Ne pas laisser la clé sur la position "P" pendant trop longtemps pour éviter de décharger la batterie de la moto.



3.6. Sélecteur de vitesses

La position N "Neutral" correspond au point mort signalé par le voyant correspondant sur le tableau de bord.

En déplaçant le sélecteur vers le bas, on engage la première vitesse.

De la même manière, en déplaçant le sélecteur vers le haut, on passe la seconde vitesse et ainsi de suite à mesure que l'on déplace le sélecteur vers le haut, on passe dans l'ordre toutes les vitesses suivantes jusqu'à la sixième.

FR 3



Sélecteur de vitesses

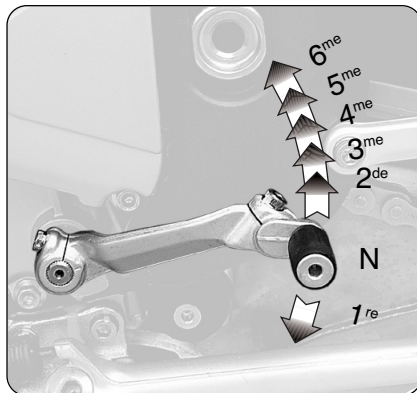



3.7. Appareils et voyants

Les appareils et les voyants sont activés lorsque la clé de contact est mise sur "ON". Après un check-up initial (~7 secondes), les informations correspondent aux conditions générales de la moto à ce moment là.

Voyants lumineux
indicateurs (§3.7.1.)

Bouton "SET" (§3.7.2.)

Ecran multifonctions (§3.7.2.)

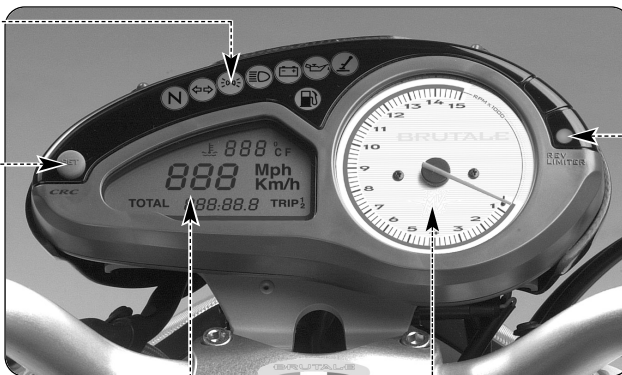

Voyant lumineux
(§3.7.1.)

Compte-tours



3.7.1. Voyants lumineux

Voyant feu de route (bleu)

Il s'éclaire lorsque le feu de route est allumé.

Voyant de charge batterie (rouge)

Il s'éclaire lorsque l'alternateur ne fournit pas le courant électrique suffisant pour charger la batterie.

Voyant feu de croisement (vert)

Il s'éclaire lorsque le feu de croisement est allumé.

S'il s'allume pendant la marche, s'adresser à un centre de réparation agréé.

Voyant d'ouverture de la béquille latérale (rouge)

Il s'allume lorsque la béquille est baissée.

Voyant de point mort (vert)

Il s'allume lorsque les vitesses sont au point mort "Neutral".

Voyant limiteur de tours (rouge)

Il s'allume lorsque le régime moteur dépasse 11300 tr/mn; le limiteur de tours intervient à 12000 tr/mn.

Voyant des feux clignotants (vert)

Il s'éclaire pendant le fonctionnement des clignotants.

Voyant de pression d'huile moteur (rouge)

Il s'allume lorsque la pression d'huile est insuffisante.



Danger - Attention: S'il s'allume en marche, il faut s'arrêter immédiatement, contrôler le niveau d'huile et, si nécessaire le faire rajouter par un centre de réparation agréé MV Agusta (voir §3.8.). Si le voyant s'allume même lorsque le niveau est correct, ne pas continuer à rouler et contacter un centre de réparation agréé.

Voyant de réserve carburant (orange)

Il s'éclaire lorsqu'il reste environ 4 litres de carburant dans le réservoir.

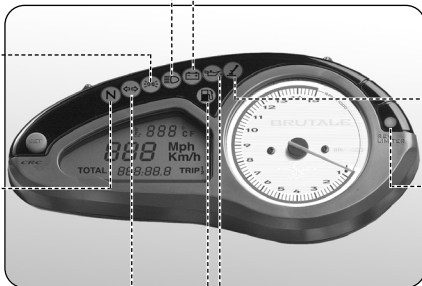



3.7.2. Affichage multifonctions

Compteur de vitesse

Il indique la vitesse qui peut être indiquée en kilomètres/heure (km/h) ou en miles/heure (Mph). La valeur maximum sur l'échelle est de 299 km/h (186 Mph).

Bouton "SET"

En appuyant dessus, il permet de sélectionner les chiffres de l'écran pour effectuer les réglages. En appuyant une seconde fois, il permet de confirmer les chiffres saisis.

Totaliseur kilométrique "TOTAL"

Il indique le nombre total de kilomètres parcourus; de 0 à 99999.9 (km ou mi)

Compteur kilométrique partiel 1 "TRIP 1"

Indique les kilomètres d'un parcours; de 0 à 9999.9 (km ou mi)

Compteur kilométrique partiel 2 "TRIP 2"

Indique les kilomètres d'un parcours ; de 0 à 9999.9 (km ou mi)

Montre de bord Indique l'heure (0-24)

Thermomètre

Indique la température du liquide de refroidissement. La valeur peut apparaître en degrés centigrades (°C) ou encore en degrés fahrenheit (°F).

L'échelle est comprise entre 40° et 140°C (104° et 284°F):

- en dessous de 40°C (104°F) l'indication n'apparaît pas mais trois tirets clignotants s'affichent, c'est le signal d'une température très basse;
- entre 40° et 49°C (104° et 120° F), l'affichage clignote, c'est le signal d'une température basse;
- entre 50° et 111°C (122° et 232° F), l'affichage est fixe;
- entre 112° et 140°C (234° et 284° F), l'affichage clignote, c'est le signal d'une température haute.

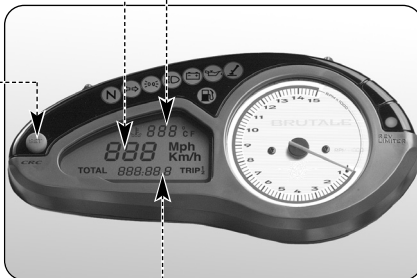

Danger - Attention: si la température dépasse les 120°C (248°F), couper le moteur et contrôler le niveau de liquide de refroidissement. Dans le cas où il serait nécessaire de le rectifier, contacter un centre de réparation agréé MV Agusta (voir §3.8.). Si le voyant s'allume bien que le niveau soit correct, ne pas continuer à rouler et contacter un centre de réparation agréé MV Agusta.



3.8. Tableau des lubrifiants et liquides

Description	Produit préconisé	Caractéristiques
Huile moteur	AGIP RACING 4T 10W/60 (*)	SAE 10W/60 - API SJ
Liquide de refroidissement	AGIP ECO - PERMANENT	Glycol-éthylène dilué à 50% avec eau distillée
Liquide d'embrayage et freins	AGIP BRAKE FLUID DOT4	DOT4
Huile de graissage de la chaîne	MOTUL CHAIN LUBE ROAD	—

* : Pour la disponibilité du produit conseillé, MV Agusta conseille de s'adresser directement aux propres concessionnaires autorisés. L'huile moteur AGIP Racing 4T 10W/60 a été réalisée spécialement pour le moteur de la motocyclette F4. Au cas où le lubrifiant décrit ne serait pas possible à trouver, MV Agusta conseille d'utiliser des huiles complètement synthétiques avec des caractéristiques conformes ou supérieures aux normes suivantes:

- Conforme API SJ
- Conforme ACEA A3
- Conforme JASO MA
- Gradation SAE 20 W-50 ou 10 W-60

NOTE

Les caractéristiques indiquées ci-dessus doivent être indiquées seules ou avec d'autres sur l'emballage de l'huile.





4.1. Utilisation de la moto

Cette partie du livret expose les principaux points qui permettent une utilisation correcte de la moto.



ATTENTION

La moto BRUTALE 910 S montre caractéristiques élevées de puissance et de performances; pour l'utilisation, il est donc requise un niveau adéquat de connaissance du véhicule. Lors de la première utilisation de la moto, il est nécessaire de garder une attitude prudente. Une agressive ou impulsive attitude de conduite peut augmenter les risques d'accidents et représenter un danger pour Votre sécurité et celle d'autrui.

4^È

ATTENTION

LES LIMITATIONS CONCERNANT L'UTILISATION ADMISE DU VEHICULE SONT REPORTÉES DANS LA SECTION "INFORMATIONS POUR LA SÉCURITÉ".



4.2. Rodage



Prudence - Précautions: le non respect des indications suivantes peut porter préjudice à la durée et aux performances de la moto.

Le rodage est communément considéré comme une phase appliquée uniquement au moteur. En réalité, il est nécessaire également pour d'autres parties importantes de la moto, en particulier les pneumatiques, les freins, la chaîne de transmission etc. Durant les premiers kilomètres adopter une conduite tranquille.

□ De 0 à 500 km (de 0 à 300 mi) (A)

Pendant cette période, varier fréquemment le régime de rotation du moteur. Si possible, préférer les parcours en colline légère avec beaucoup de virages et éviter les longues lignes droites.

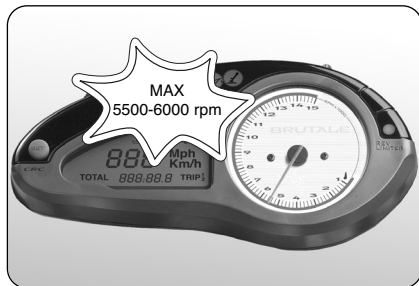

ATTENTION

Les pneumatiques neufs doivent être soumis à un rodage adéquat pour atteindre une efficacité complète. Éviter les accélérations, les virages et les freinages brusques pendant les premiers 100 km. Si la période de rodage initial des pneus n'est pas respectée, il y a risque de dérapage ou de perte de contrôle du véhicule entraînant un grave danger d'accident.



□ De 500 à 1000 km (de 300 à 600 mi)

Pendant cette période, éviter les efforts prolongés du moteur.

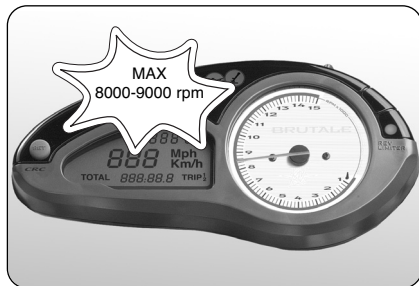

□ De 1000 à 2500 km (de 600 à 1600 mi)

Pendant cette période, il est possible de pousser un peu plus le moteur sans toutefois dépasser le régime indiqué.

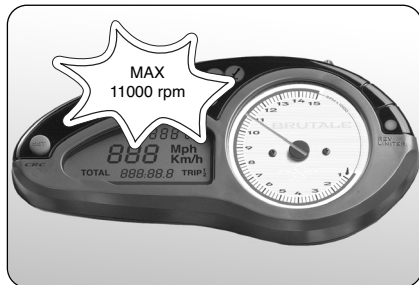



4.3. Démarrage



ATTENTION

Faire fonctionner le moteur dans un espace clos peut être dangereux. Les gaz d'échappement contiennent du monoxyde de carbone, un gaz incolore et inodore qui peut provoquer la mort ou des accidents graves. Faire fonctionner le moteur uniquement à l'extérieur, à l'air libre.

4

► Tourner le contacteur principal en position "ON", les voyants et indicateurs effectuent l'autodiagnostic. Pendant cette phase, veiller à ce que tous les voyants du tableau de bord s'allument. Pour que le système de sûreté du circuit d'allumage donne l'autorisation au démarrage, l'une de ces conditions doit être remplie:

- Le sélecteur est en position de point mort.
- Le sélecteur se trouve sur une vitesse avec le débrayage tiré et la béquille latérale levée.

☐ Démarrage à froid

► Tourner le levier "CHOKE" sans tourner la poignée d'accélérateur et appuyer sur le bouton.





► Dès que le moteur démarre, relâcher le bouton et après un bref chauffage, ramener le levier sur sa position initiale.

❑ Démarrage à chaud

► Appuyer sur le bouton sans tourner la poignée de l'accélérateur.

► Dès que le moteur tourne, relâcher le bouton.



Rappel – Précautions:

- Pour éviter les dommages au circuit électrique, ne pas actionner le démarreur plus de 5 secondes consécutives.

- Ne pas faire tourner trop longtemps le moteur lorsque la moto est à l'arrêt. La surchauffe peut endommager les composants intérieurs du moteur. Il est préférable de chauffer le moteur en se mettant en route à une allure réduite.

- Pour préserver au maximum la durée de vie du moteur, ne pas accélérer à fond lorsque le moteur est froid.



4





4.4. Sélection et modification des fonctions d'affichage

L'instrumentation prévoit la possibilité d'intervenir sur quelques-uns des paramètres principaux de mesure.

Les opérations possibles sont:

- Sélection des fonctions:

Totaliseur kilométrique	Total	"TOTAL"
Compteur kilométrique	Partiel 1	"TRIP 1"
Compteur kilométrique	Partiel 2	"TRIP 2"
Horloge		
- Réglage des unités de mesures relatives à :
 - Vitesse
 - Distance parcourue
 - Température
- Mise à zéro des fonctions compteurs kilométriques partiels:

Compteur kilométrique	Partiel 1	"TRIP 1"
Compteur kilométrique	Partiel 2	"TRIP 2"
- Réglage de la fonction horloge.





4.4.1. Sélection des fonctions d'affichage

La sélection concerne les fonctions:

- totaliseur kilométrique "TOTAL"
- compteur kilométrique partiel 1 "TRIP 1"
- compteur kilométrique partiel 2 "TRIP 2"
- montre.

► Pour l'affichage des fonctions "TOTAL", "TRIP 1" et "TRIP 2", appuyer sur le bouton du démarreur. En agissant sur ces boutons, les fonctions s'affichent en mode cyclique. Sélectionner la fonction désirée.

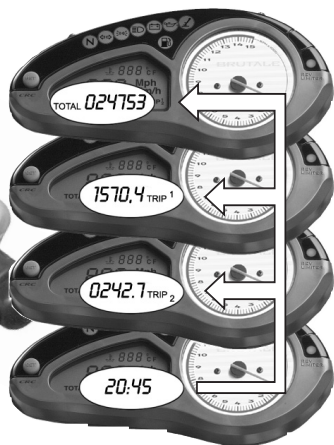

4



ATTENTION

Les opérations de modification ou de réglage des fonctions d'affichage doivent être effectuées avec le moteur allumé, le sélecteur de vitesses au point mort, la moto à l'arrêt et les pieds au sol. Il est interdit de changer les réglages de l'affichage en cours de route.



4.4.2. Réglage de l'unité de mesure

Il est possible de modifier l'unité de mesure.



ATTENTION

Les opérations de modification ou de réglage des fonctions d'affichage doivent être effectuées avec le moteur allumé, le sélecteur de vitesses au point mort, la moto à l'arrêt et les pieds au sol. Il est interdit de changer les réglages de l'affichage en cours de route.



□ Le compteur de vitesses (km/h - Mph)

▶ Appuyer de manière répétée sur le bouton du démarreur jusqu'à l'affichage de la fonction totaliseur kilométrique "TOTAL".

▶ Appuyer sur le bouton "SET"; l'unité de mesure du compteur de vitesse commence à clignoter.





► Appuyer sur le bouton du démarreur pour passer de km/h à Mph ou inversement. En modifiant l'unité de mesure du compteur de vitesse, celle des compteurs-kilométriques (totaliseur ou partiels) est automatiquement modifiée.

Rappel: 1 mi = 1,609 km

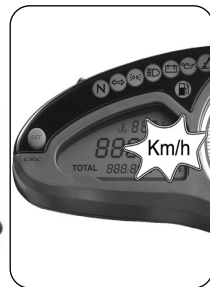

4^{FE}

► Appuyer sur le bouton "SET"; l'unité de mesure du compteur de vitesses est validée et l'unité de mesure du thermomètre commence à clignoter. Il est possible de passer au réglage suivant.





□ Thermomètre (° C - ° F)

► Appuyer sur le bouton du démarreur pour passer de °C à °F ou inversement.

Rappel: $T (°F) = 1,8 \cdot t(°C) + 32$



► Appuyer sur le bouton “SET” pour valider l’unité de mesure.





4.4.3. Mise à zéro des fonctions de compteurs kilométriques partiels

Les valeurs des fonctions “TRIP1” et “TRIP2” peuvent se remettre à zéro de la manière suivante.



ATTENTION

Les opérations de modification ou de réglage des fonctions d'affichage doivent être effectuées avec le moteur allumé, le sélecteur de vitesses au point mort, la moto à l'arrêt et les pieds au sol. Il est interdit de changer les réglages de l'affichage en cours de route.

► Appuyer sur le bouton du démarreur pour actionner la fonction “TRIP 1”.

► Appuyer sur le bouton du démarreur pendant un laps de temps supérieur à 4 secondes, la valeur “TRIP 1” se met à clignoter.





► En appuyant maintenant sur le bouton du démarreur, pendant un laps de temps inférieur à 4 secondes, la valeur se remet à zéro. Si le bouton reste appuyé plus de 4 secondes, la procédure de remise à zéro est interrompue.



4

► En appuyant sur le bouton du démarreur du moteur, activer la fonction "TRIP 2".





- ▶ Appuyer sur le bouton du démarreur pendant un laps de temps supérieur à 4 secondes; la valeur "TRIP 2" commence à clignoter.



4 **FF**

- ▶ En appuyant maintenant sur le bouton du démarreur, pendant un laps de temps inférieur à 4 secondes, la valeur se remet à zéro. Si le bouton reste appuyé plus de 4 secondes, la procédure de remise à zéro est interrompue.





4.4.4. Réglage de la fonction horloge

Il est possible de régler la fonction horloge.



ATTENTION

Les opérations de modification ou de réglage des fonctions d'affichage doivent être effectuées avec le moteur allumé, le sélecteur de vitesses au point mort, la moto à l'arrêt et les pieds au sol. Il est interdit de changer les réglages de l'affichage en cours de route.



► Appuyer de manière répétée sur le bouton du démarreur du moteur jusqu'à l'affichage de la fonction horloge.

► Appuyer sur le bouton "SET", le premier chiffre de l'heure commence à clignoter.





► Appuyer sur le bouton du démarreur pour le réglage du nombre. Relâcher dès que le nombre correct est atteint.

NOTE

Pour obtenir le défilement rapide des nombres sélectionnés, tenir le bouton du démarreur enfoncé pendant plus de deux secondes.

► Appuyer sur le bouton “SET” pour confirmer ou pour procéder au réglage du chiffre suivant.

► Répéter le procédé pour régler le second chiffre des heures, le premier et le second chiffre des minutes.

► Appuyer sur le bouton “SET” pour valider le réglage de l’heure et interrompre la sélection (le clignotement).

NOTE

L’instrumentation dispose d’une mémoire intégrale qui conserve tous les paramètres même à moteur coupé. A l’exception de l’horloge, qui est remise à zéro, tous les autres paramètres restent en mémoire même en cas de débranchement de la batterie.

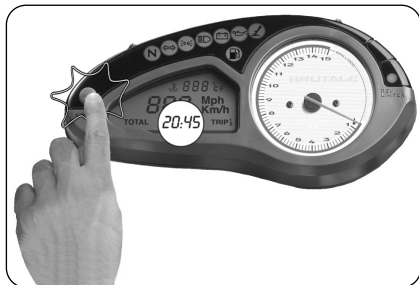



4.5. Approvisionnement en carburant



Danger - Attention: l'essence et ses vapeurs sont extrêmement inflammables et nocifs. Eviter le contact et l'inhalation. Pendant l'approvisionnement, couper le moteur, ne pas fumer, tenir à distance les flammes, étincelles et sources de chaleur. Effectuer l'approvisionnement à l'air libre ou dans un local suffisamment aéré.



Rappel - Précaution: utiliser exclusivement de l'essence super sans plomb avec un indice d'octane (R.O.N.) de 95 ou plus. Cette nécessité est rappelé par une pastille verte sur le côté inférieur du bouchon du réservoir.

- ▶ Soulever le cache poussière.
- ▶ Introduire la clé, tourner dans le sens des aiguilles d'une montre.

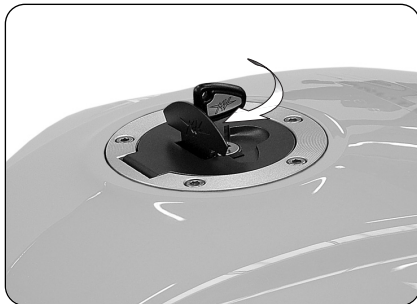
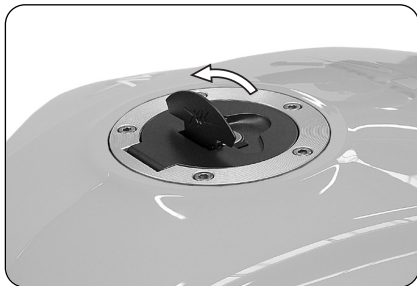



► Soulever le couvercle et effectuer le ravitaillement en carburant.



ATTENTION: Un remplissage excessif du réservoir peut faire déborder le carburant à cause de l'expansion due à la chaleur du moteur ou à l'exposition de la moto à la lumière du soleil. Les écoulements éventuels de carburant peuvent provoquer des incendies. Le niveau de carburant dans le réservoir ne doit jamais dépasser la base de l'embout de remplissage.

► Une fois l'approvisionnement effectué, pousser le bouchon vers le bas en tournant simultanément la clé dans le sens des aiguilles d'une montre pour faciliter la fermeture, puis relâcher la clé et l'extraire.



Rappel - Précaution: sécher immédiatement avec un chiffon propre le carburant éventuellement renversé, car il peut détériorer les peintures ou les plastiques.



ATTENTION: Vérifier que le bouchon du réservoir à carburant est fermé correctement avant d'utiliser le véhicule.

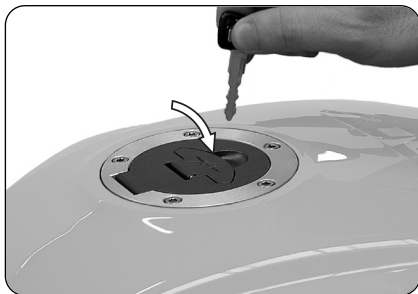
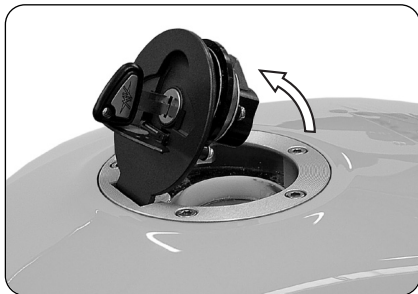



4.6. Accès à la boîte à gants

► Introduire la clé dans la serrure.

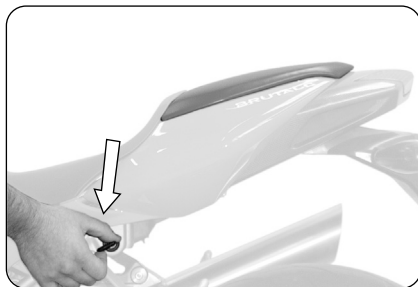

► Tourner la clé dans le sens des aiguilles d'une montre et simultanément appuyer légèrement sur la selle du passager. Soulever la selle.





► Extraire la selle du passager.

Pour remonter l'élément, procéder de la façon suivante:

- Tourner la clé dans la serrure.
- Presser la selle du passager.
- Relâcher la clé.
- Presser à nouveau la selle en s'assurant qu'elle est fermement accrochée à la structure.



4



ATTENTION

Après avoir enlevé ou soulevé la selle du passager et en tout cas avant d'utiliser la moto, s'assurer que l'élément a été placé correctement et qu'il est fermement assujéti à la structure portante du véhicule.



4.7. Stationnement de la moto

□ Stationnement avec béquille latérale



ATTENTION: Garer la moto en conditions de sécurité et sur un terrain stable. Pour le stationnement en côte, garer la moto avec la roue avant en amont et la première vitesse engagée. Ne pas oublier de remettre le sélecteur de vitesses au point mort avant de redémarrer la moto. Ne pas laisser le véhicule sans surveillance avec la clé sur le contact. Lorsque le véhicule stationne sur la béquille latérale, il est dangereux de s'asseoir dessus

► Abaisser la béquille avec le pied jusqu'à la butée et incliner lentement la moto pour mettre le pied d'appui au contact du sol.

et de peser avec tout le poids du corps sur l'unique appui de stationnement. Avant de se mettre en route, vérifier le fonctionnement de l'interrupteur de sûreté en s'assurant que le voyant d'ouverture de la béquille latérale sur le tableau de bord s'éteint. Dans tous les cas, vérifier que la béquille est bien rentrée. En cas de fonctionnement défectueux, faire contrôler le dispositif par un concessionnaire MV Agusta avant d'utiliser la moto.

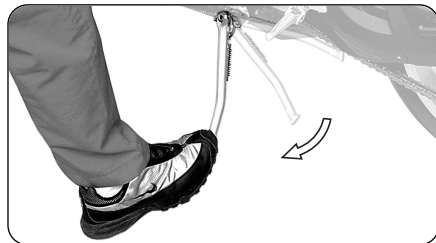



□ Stationnement avec la béquille arrière

Introduire l'axe de béquille dans l'orifice de l'axe de roue arrière du côté gauche de la moto. Appuyer la béquille au sol et en forçant dessus, soulever le véhicule jusqu'à ce qu'il se stabilise.



ATTENTION

Cette opération doit être effectuée par deux personnes.

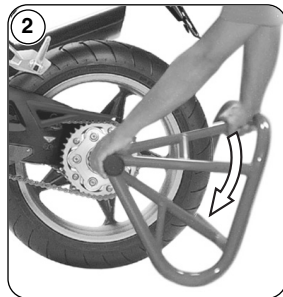
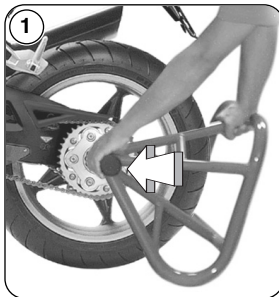



5.1. Liste des réglages

La moto dispose d'une grande diversité de réglages qui peuvent améliorer l'ergonomie, l'assiette et la sécurité.

Toutefois, étant donné qu'un réglage incorrect de pièces particulièrement importantes peut engendrer une situation de danger, quelques-uns des réglages sont réservés aux Centres d'Assistance MV Agusta.



ATTENTION

Tous les réglages s'effectuent à l'arrêt.



(F) Réglage du rétroviseur (§5.5.)

(A) Réglage du levier de frein avant (§5.3.)

(C) Réglage du cale-pied droit (§5.2)

(H) Réglage de la suspension arrière (§5.7.)

(E) Réglage de la pédale de frein arrière (§5.2.)

(G) Réglage de la suspension avant (§5.6)

(M) Orientation du phare (§5.8.)

(G) Réglage de la suspension avant (§5.6)

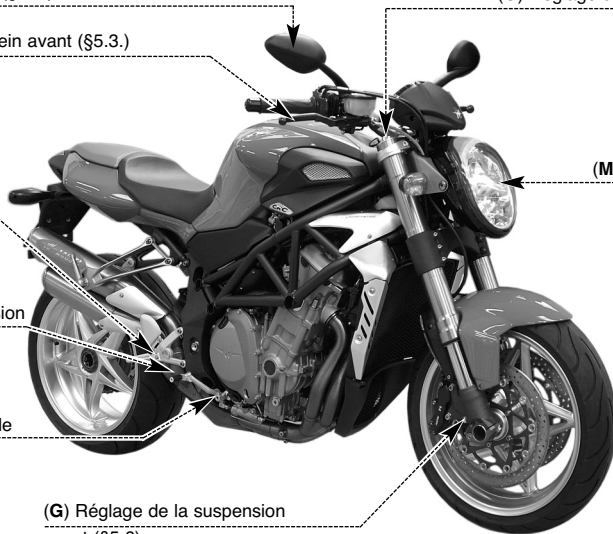



(F) Réglage du rétroviseur (§5.5.)

(H) Réglage de la suspension arrière (§5.7.)

(B) Réglage du levier
d'embrayage (§5.4.)

(D) Réglage du sélecteur
de vitesses (§5.2.)

(C) Réglage du cale-pied gauche (§5.2.)

(L) Réglage de
la chaîne (§5.2.)

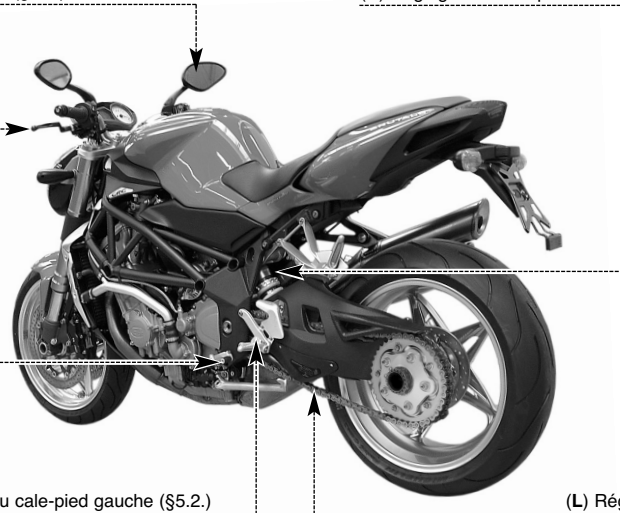



5.2. Tableau des réglages

	A - Réglage du levier de frein avant: pour améliorer la prise en fonction des nécessités du pilote (§5.3.).	G - Réglage de la suspension avant: pour adapter la réponse aux préférences du motard, on peut régler: <ul style="list-style-type: none">- la précharge du ressort (§5.6.1.)- le dispositif hydraulique de freinage en détente (§5.6.2.)- le dispositif hydraulique de freinage en compression (§5.6.3.)	
	B - Réglage du levier d'embrayage: pour améliorer la prise en fonction des nécessités du pilote (§5.4.).	H - Réglage de la suspension arrière: pour adapter la réponse aux préférences du motard, on peut régler: <ul style="list-style-type: none">- la précharge du ressort- la hauteur d'assiette	
	C - Réglage du cale-pied (droit et gauche): pour améliorer la position des pieds en fonction des nécessités du pilote		<ul style="list-style-type: none">- le dispositif hydraulique de freinage en détente (§5.7.1.)
	D - Réglage du sélecteur de vitesses: pour améliorer le mouvement de commande en fonction des nécessités du pilote.		<ul style="list-style-type: none">- le dispositif hydraulique de freinage en compression pour vitesse élevée (§5.7.2.)- le dispositif hydraulique de freinage en compression pour vitesse basse (§5.7.3.)
	E - Réglage de la pédale de frein arrière: pour améliorer le mouvement de commande en fonction des nécessités du pilote.		L - Tension de la chaîne: pour l'efficacité et la fiabilité de la transmission.
	F - Réglage de l'amortisseur de direction: pour adapter la dureté de la direction aux préférences du pilote (§5.5). ATTENTION: Ne pas toucher la vis de fixation du rétroviseur au guidon. En cas de besoin, s'adresser à un concessionnaire MV AGUSTA.		M - Orientation du phare: pour optimiser la profondeur du faisceau lumineux en fonction de l'assiette (§5.8).



5.3. Réglage du levier de frein avant

Tirer le levier pour neutraliser la poussée du ressort et simultanément, régler la position en vissant ou en dévissant l'écrou. En vissant: le levier s'éloigne de la poignée. En dévissant: le levier se rapproche de la poignée.

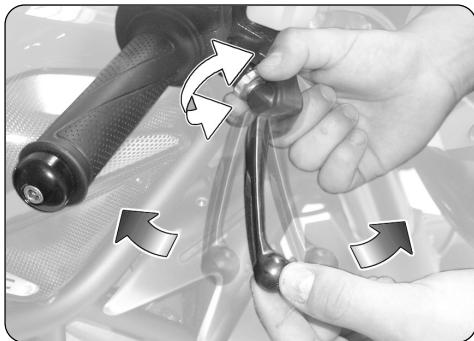

5.4. Réglage du levier d'embrayage

Tirer le levier pour neutraliser la poussée du ressort et simultanément, régler la position en vissant ou en dévissant l'écrou. En vissant: le levier s'éloigne de la poignée. En dévissant: le levier se rapproche de la poignée.





5.5. Réglage des rétroviseurs

Pousser sur les points indiqués pour orienter le rétroviseur dans les quatre directions.

Régler les deux rétroviseurs. Pour une mise au point optimale, monter sur le véhicule pour réaliser le réglage.

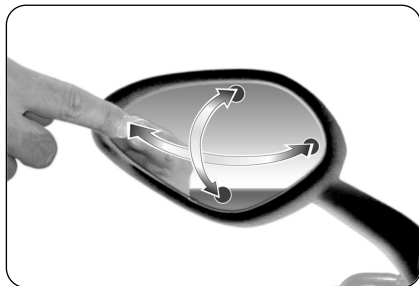



5.6. Réglage de la suspension avant



ATTENTION: Il est impératif que les bagues des deux tubes de fourche soient réglées sur la même position.

NOTE: L'ajustement des suspensions doit être de préférence effectué avec le réservoir de carburant plein.

Dispositif hydraulique de freinage en détente

Précharge du ressort

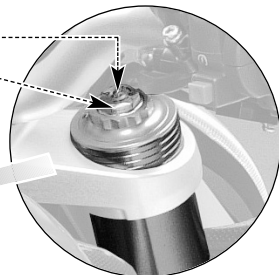

Dispositif hydraulique de freinage en compression

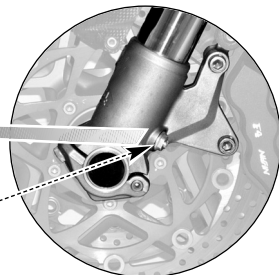



5.6.1. Précharge du ressort

Le réglage s'effectue en partant de la position standard. Pour trouver cette position, il faut dévisser à fond, puis visser jusqu'à la position standard (voir tableau annexe).

Visser pour augmenter la précharge du ressort ou dévisser pour la diminuer.



5.6.2. Dispositif hydraulique de freinage en détente (suspension avant)

Le réglage s'effectue en partant de la position standard. Pour trouver cette position, il faut visser à fond, puis dévisser jusqu'à la position standard (voir tableau annexe).

Visser pour augmenter l'action du freinage ou dévisser pour la diminuer.

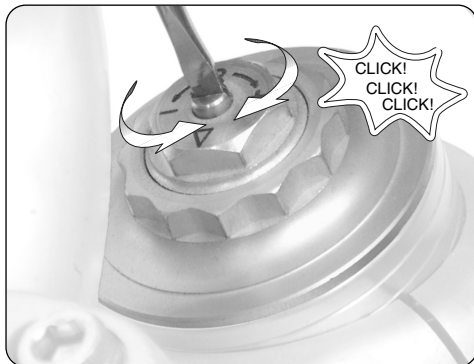



5.6.3. Dispositif hydraulique de freinage en compression (suspension avant)

Le réglage s'effectue en partant de la position standard. Pour trouver cette position, il faut visser à fond, puis dévisser jusqu'à la position standard (voir tableau annexe).

Visser pour augmenter l'action du freinage ou dévisser pour la diminuer.

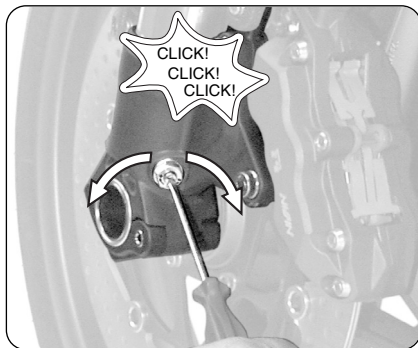



5.7. Réglage de la suspension arrière



ATTENTION: la haute température des tuyaux d'échappement peut provoquer des brûlures. Couper le moteur et attendre que les tuyaux d'échappement aient refroidi avant d'effectuer le réglage.

NOTE: L'ajustement des suspensions doit être de préférence effectué avec le réservoir de carburant plein.

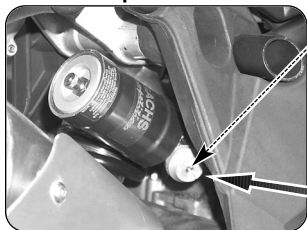

Dispositif hydraulique de freinage en compression
(pour vitesse élevée et vitesse basse)

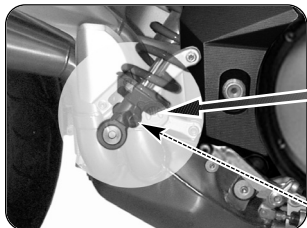

Dispositif hydraulique de freinage en détente



5 FR



5.7.1. Dispositif hydraulique de freinage en détente (suspension arrière)

Pour effectuer cette mise au point, agir sur la vis qui se trouve dans la partie inférieure de l'amortisseur en partant de la position standard.

Pour trouver cette position, il faut visser à fond, puis dévisser jusqu'à la position standard (voir tableau).
Visser pour augmenter l'action du freinage ou dévisser pour la diminuer.

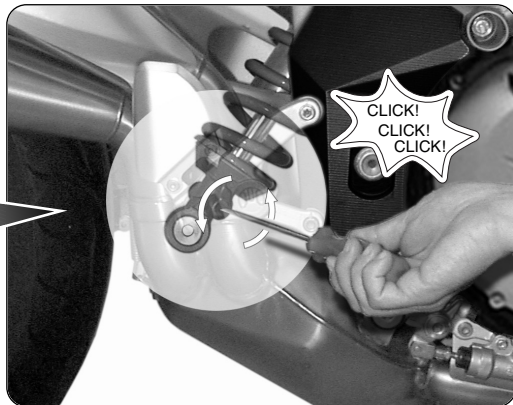



5.7.2. Dispositif hydraulique de freinage en compression pour vitesse élevée (suspension arrière)

Pour effectuer cette mise au point, agir sur la bague qui se trouve dans la partie supérieure de l'amortisseur en partant de la position standard. Pour trouver cette position, il faut dévisser à fond, puis visser jusqu'à la position standard (voir tableau annexe). Visser pour augmenter l'action du freinage ou dévisser pour la diminuer.



5.7.3. Dispositif hydraulique de freinage en compression pour vitesse basse (suspension arrière)

Pour effectuer cette mise au point, agir sur la vis qui se trouve dans la partie supérieure de l'amortisseur en partant de la position standard. Pour trouver cette position, il faut visser à fond, puis dévisser jusqu'à la position standard (voir tableau annexe). Visser pour augmenter l'action du freinage ou dévisser pour la diminuer.





5.8. Réglage du projecteur avant

Placer le véhicule à 10 mètres d'une paroi verticale.

Veiller à ce que le terrain soit plat et l'axe du véhicule perpendiculaire à la paroi.

Le véhicule doit se trouver en position verticale. Mesurer la hauteur du centre du projecteur au sol et faire une croix sur la paroi à la même hauteur.

Allumer le code, la limite supérieure de démarcation entre la zone sombre et la zone éclairée ne doit pas dépasser $9/10$ de la hauteur au sol du centre du projecteur.

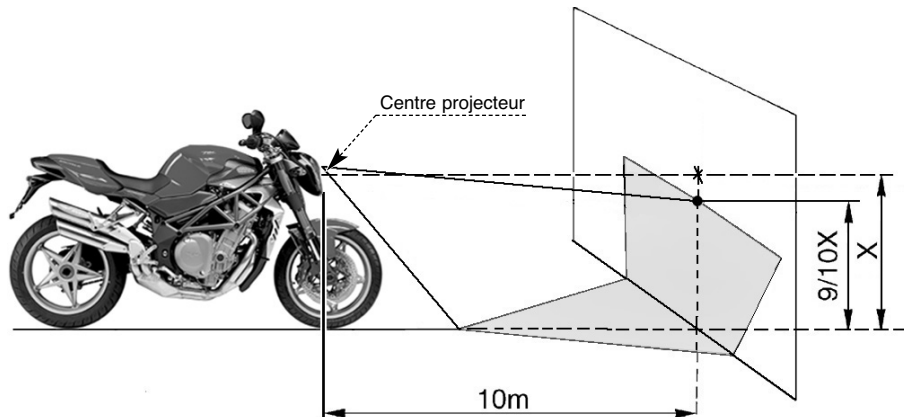



Pour la mise au point du phare antérieur, agir sur la vis représentée ci-contre. Dans le sens des aiguilles d'une montre: le phare s'incline vers le bas. Dans le sens contraire de celui des aiguilles d'une montre: le phare s'incline vers le haut. L'inclinaison peut varier de $\pm 4^\circ$ par rapport à la position standard.

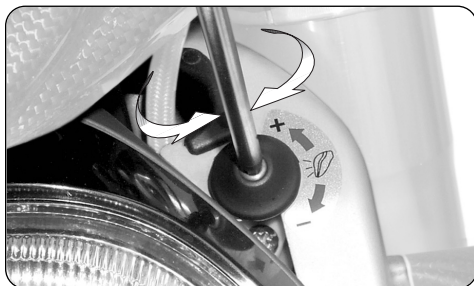
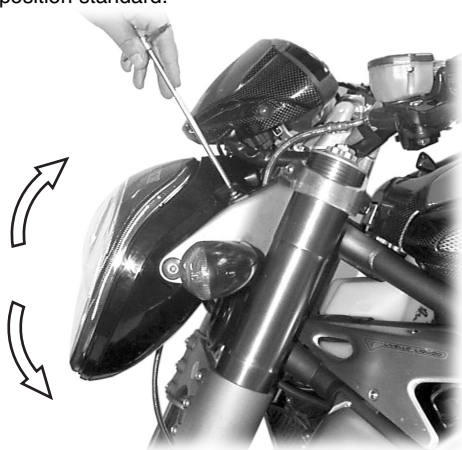



Note d'information

MV Agusta S.p.A. poursuit une politique de continuelle amélioration de ses produits. Pour cette raison, de légères différences pourraient éventuellement se présenter entre les informations de ce livret et le véhicule que vous avez acheté. Les modèles MV Agusta s'exportent dans de nombreux pays où des normes différentes sont en vigueur en ce qui concerne le Code de la Route et les procédures d'homologation. En espérant pouvoir compter sur votre compréhension, il est indispensable à MV Agusta S.p.A. de se réserver le droit d'apporter des modifications à ses produits et à la documentation technique à tout moment sans fournir de préavis.

Nous suggérons de visiter souvent le site Internet **www.mvagusta.it** afin d'obtenir des informations et des mises à jour sur les produits MV Agusta et la documentation relative.



Respectons et défendons l'environnement

Toutes nos actions ont des répercussions sur la planète entière et sur ses ressources. MV Agusta, au profit des intérêts de tous, sensibilise les Clients et les opérateurs du service après-vente pour leur faire adopter des modalités d'utilisation du véhicule et de traitement de ses parties dans le respect des normes en vigueur en terme de pollution, traitement et recyclage des déchets.

© 2006

Toute reproduction même partielle de ce document est formellement interdite sans autorisation écrite de MV Agusta S.p.A.

Dét. n° 8000A9724

Edition n° 1 - Octobre 2006

MV AGUSTA

**910
BRUTALE**



Bedienungsanleitung
Deutsche Version

Sehr geehrter Kunde,

wir danken Ihnen für das Vertrauen, dass Sie uns ausgesprochen haben und gratulieren Ihnen zur Wahl Ihres neuen F4 Brutale 910 S.

Dank dem beharrlichen Einsatz und Engagement seiner Techniker ist heute MV Agusta in der Lage seinen zahlreichen Fans ein innovatives und von einer Sonderverkleidung und raffinierter Radtechnologie charakterisiertes Produkt anzubieten: Elemente die alle mit dem MV Agusta Warenzeichen verzeichneten Erzeugnisse in der langen Zeitspanne seiner ruhmreichen Unternehmensgeschichte gekennzeichnet haben.

Das Ergebnis ist ein exklusives Motorrad, das dank seinen ästhetischen und funktionellen Eigenschaften sowie den zahlreichen technischen Innovationen weit über den heutigen auf diesem Markt vertriebenen Qualitätsprodukten liegt.

Die angewandten Lösungen verleihen dem neuen F4 Brutale 910 S einen unverwechselbaren Charakter, der dieses Motorrad zu den anderen Modellen der Familie MV Agusta anknüpft und die Projektphilosophie dieses Unternehmens, das der ständigen Forschung, und der technologischen Innovation besonders Wert schenkt und das winzigste Detail schätzen kann, konsolidiert. Jedem Motorradfahrer wird somit die Möglichkeit geschenkt, seine Leidenschaft in voller Freiheit zu genießen und zur gleichen Zeit ein Motorrad zu besitzen, das einzig auf der Welt ist und sich weltweit mit starkem Übergriff durchsetzt.

Falls Sie weitere Informationen wünschen, wenden Sie sich bitte an den Kundendienst der MV Agusta.

Viel Spaß!

*Claudio Castiglioni
Präsident
MV Agusta*



ALLGEMEINES INHALTSVERZEICHNIS

<i>Kap.</i>	<i>Inhalt</i>	<i>Seite</i>
1	ALLGEMEINE INFORMATIONEN	5
1.1.	Zweck der Bedienungsanleitung	5
1.2.	Zeichenerklärung	6
1.3.	Inhalt der CD-Rom	7
1.4.	Rahmen- und Motornummer	8
2	SICHERHEITSINFORMATIONEN	11
2.1.	Sachgemässer gebrauch des Fahrzeuges	11
2.2.	Wartung	11
2.3.	Zubehör und Änderungen	12
2.4.	Fahrzeugbeladung	12
3	BEDIENUNGSELEMENTE UND INSTRUMENTE	14
3.1.	Anbringung der Bedienungselemente und Instrumente	14
3.2.	Seitlicher Ständer	16
3.3.	Bedienungselemente links am Lenker	17
3.4.	Bedienungselemente rechts am Lenker	19
3.5.	Zündschloß und Lenkerschloß	22
3.6.	Schaltung	26
3.7.	Instrumente und Kontrollampen	27
3.7.1.	Kontrollampen	28
3.7.2.	Multifunktions-Display	29
3.8.	Schmiermitteltabelle	30

<i>Kap.</i>	<i>Inhalt</i>	<i>Seite</i>
4	EINSATZ	31
4.1.	Einsatz des Motorrads	31
4.2.	Einfahren	32
4.3.	Starten des Motors	34
4.4.	Auswahl und Modifizieren der Display-Funktionen	36
4.4.1.	Auswahl der Display-Funktionen	37
4.4.2.	Einstellen des Maßeinheiten	38
4.4.3.	Nullstellen der Tageskilometerzähler	41
4.4.4.	Einstellen der Uhrzeit	44
4.5.	Tanken	46
4.6.	Zugang zum Staufach	48
4.7.	Parken des Motorrads	50
5	EINSTELLUNGSARBEITEN	52
5.1.	Liste der Einstellungsarbeiten	52
5.2.	Tabelle der Einstellungsarbeiten	55
5.3.	Einstellung Bremshebel Vorderradbremse	56
5.4.	Einstellung Kupplungshebel	56
5.5.	Einstellung Rückspiegel	57
5.6.	Einstellung vordere Federung	58
5.6.1.	Federvorspannung	59



ALLGEMEINES INHALTSVERZEICHNIS

<i>Kap.</i>	<i>Inhalt</i>	<i>Seite</i>
5.6.2.	Hydraulische Ausdehnungsbremse (Vorderradfederung)	59
5.6.3.	Hydraulische Kompressionsbremse (Vorderradfederung)	60
5.7.	Einstellung hintere Federung	61
5.7.1.	Hydraulische Ausdehnungsbremse (Hinterradfederung)	62
5.7.2.	Hydraulische Kompressionsbremse für hohe Gänge (Hinterradfederung)	63
5.7.3.	Hydraulische Kompressionsbremse für niedrige Gänge (Hinterradfederung)	63
5.8.	Scheinwerfereinstellung	64



1.1. Zweck der Bedienungsanleitung

Dieses Handbuch enthält alle für einen korrekten und sicheren Gebrauch Ihres Motorrads erforderlichen Informationen.

Zusammen mit dem Handbuch erhalten Sie auch ein Quick Manual im Taschenformat mit den wichtigsten gebrauchswichtigen Informationen.

Das Handbuch wird in elektronischem Format (.pdf) auf dieser CD-Rom geliefert und kann auf jedem PC mit Windows oder Mac eingesehen oder ausgedruckt werden.

Wir bitten Sie, dieses Handbuch vor der ersten Benutzung des Motorrads aufmerksam durchzulesen und sich immer zu vergewissern, dass auch andere Personen, die das Motorrad benutzen, dies tun.

Vergessen Sie bitte nicht, in das Quick Manual Ihre Daten und die Daten Ihres Motorrads einzutragen und es immer mitzuführen.



Copyright
MV AGUSTA Motor Spa
Alle Rechte vorbehalten



1.2. Zeichenerklärung

Besonders wichtige Textstellen die sich auf die Sicherheit der Personen oder des Fahrzeugs beziehen, sind mit folgenden Symbolen gekennzeichnet:



Gefahr - Achtung: Die mangelnde oder unvollständige Beachtung dieser Vorschriften stellt eine schwere Unfallgefahr für den Arbeiter oder Dritte dar.



Vorsicht - Vorsichtsmaßnahme: Die Nichteinhaltung der Anweisungen kann schwere und dauerhafte Schäden am Fahrzeug verursachen.

Folgende Symbole werden benutzt, um anzuzeigen, wer die angegebenen Wartungs- und Einstellarbeiten ausführen darf:



Informationen zu Arbeiten, die vom Motorradfahrer ausgeführt werden dürfen.



Informationen zu arbeiten, die ausschließlich von ausgebildetem Fachpersonal ausgeführt werden dürfen.

Um weitere Informationen hervorzuheben, werden folgende Symbole verwendet:



Das Symbol  zeigt an, dass für die richtige Durchführung der angegebenen Arbeit ein Spezialwerkzeug oder Sonderausrüstung benötigt werden.



Das Zeichen “§” gefolgt von einer Ziffer verweist auf das entsprechende Kapitel.



1.3. Inhalt der CD-Rom

Auf dieser CD-Rom finden Sie außer diesem Handbuch auch das Wartungshandbuch, das Quick Manual (das Sie auch als Büchlein erhalten haben), die Händlerliste und das Garantieheft.

Bei der Übergabe des Motorrades hat Ihnen Ihr Händler auch das Garantiebescheinigung ausgehändigt.

Bewahren Sie es bitte sorgfältig zusammen mit den Fahrzeugpapieren und den zukünftigen Bescheinigungen auf, die Sie bei jeder Inspektion ausgehändigt bekommen werden.

WICHTIG

Eine Kopie der Garantiebescheinigung muß vom Vertragshändler ausgefüllt und innerhalb von 10 Tagen nach Zulassung an die MV Agusta geschickt werden.

Die Wartungscoupons müssen nach Abschluss der jeweiligen Wartungsarbeiten ebenfalls innerhalb von 10 Tagen vom Vertragshändler ausgefüllt und an die MV Agusta geschickt werden.



1.4. Données d'identification

- 1) numéro de série du cadre
- 2) numéro de série du moteur
- 3) données d'homologation

► Identification de la moto

La moto est identifiable grâce au numéro de série du cadre. Pour les commandes de pièces détachées, il peut être nécessaire d'indiquer également le numéro de série du moteur, le code couleur et le numéro d'identification des clés.

Il est conseillé de noter les données principales dans les espaces ci-dessous:

CADRE N.: _____

MOTEUR N.: _____



► Schlüsselnummer

Sie erhalten einen Schlüssel und einen Ersatzschlüssel. Die Schlüssel dienen als Zündschlüssel und zum Öffnen aller Schlösser. Den Ersatzschlüssel an einem sicheren Ort aufbewahren.

Bei Nachfrage eines Duplikates ist die Kenntnis der Identifikationsnummer des Schlüssels grundlegend. Tragen Sie Ihre Schlüsselnummer hier ein:

SCHLÜSSELNUMMER:

► Farbkennziffer

Die Farbkennziffer wird bei Bestellung von Karosserieteilen benötigt. Sie befindet sich auf dem linken unteren Seite des Benzintanks.

Um das Farbkennzifferschild zu lesen, ist es notwendig das linker seitlicher Tankteil zu lösen. Ziehen Sie die Rückseite der linken seitlichen Tankteil aus, wie in der Abbildung gezeigt.

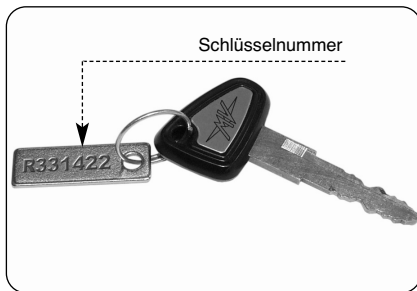

1 DE

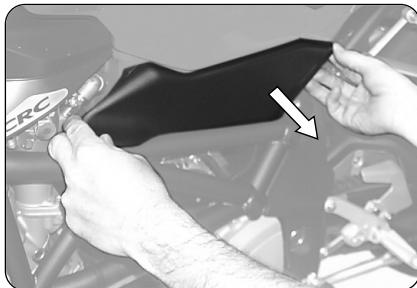



DE 1

Entfernen Sie die linke seitliche Tankteile, indem Sie sie zur Rückseite des Motorrads ziehen.

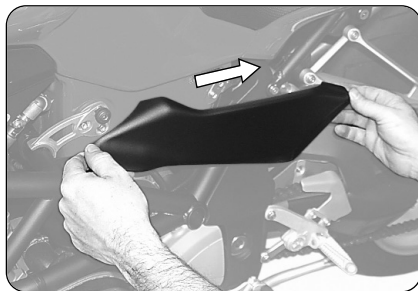

Nach Tankteilbeseitigung, ist es möglich, das Farbkennzifferschild zu sehen. Auf dem Schild ist die jeweilige Farbekennziffer des Motorrads zur Lackierung der Karosserieteile angegeben.

Es wird geraten, die Farbkennziffer des Motorrads im nachfolgenden Leerraum einzutragen:

FARBKENNZIFFER:

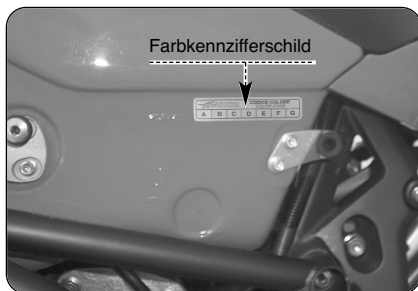



2.1. SACHGEMÄSSER GEBRAUCH DES FAHRZEUGES

Ihr Motorrad wurde ausschließlich für die Benutzung auf Straßen und Autobahnen geplant.



ACHTUNG

Ausnahme können Sie Ihr Motorrad auch auf einer Rennstrecke benutzen – allerdings nicht, um Rennen zu fahren.

Dabei ist das Motorrad jedoch sehr hohen Beanspruchungen ausgesetzt und daher sollte es vorher und nachher in einer MV Agusta-Vertragswerkstatt überprüft werden.

Jeder andere Einsatz ist ausdrücklich ausgeschlossen und strengstens untersagt.

Weitere Informationen zur Benutzung des Motorrads finden Sie im Abschnitt 4 dieses Handbuchs.

2.2. WARTUNG

Damit Ihr Motorrad stets einwandfrei und zuverlässig funktioniert, müssen Sie die im Wartungshandbuch vorgesehenen Inspektionstermine unbedingt einhalten.

Sie sollten diese ausschließlich von Fachleuten in einer MV Agusta-Vertragswerkstatt durchführen lassen.

Sollten Sie sich hingegen für eine freie Werkstatt entscheiden, müssen Sie sich von dieser bestätigen lassen, dass sie über alle für die Durchführung der erforderlichen Kontrollen und Einstellungen notwendigen Ausrüstungen, Möglichkeiten und Kenntnisse verfügt.



ACHTUNG

Die Garantie von MV Agusta könnte im Fall von in freien Werkstätten ausgeführten Eingriffen an Ihrem Motorrad, die nicht den technischen Rundschreiben und den MV Agusta-Werkstatthandbüchern entsprechen, verfallen.



2.3. ZUBEHÖR UND ÄNDERUNGEN



ACHTUNG

Der Hersteller untersagt jegliche eigenmächtige Änderung an seinen Fahrzeugen.

Nur so kann die Sicherheit der Benutzer gewährleistet werden.

Allerdings besteht die Möglichkeit, Ihr Motorrad anhand des umfangreichen MV Agusta-Zubehörkatalogs zu personalisieren.



ACHTUNG

Durch die Installation einiger dieser Zubehörteile kann die Zulassung des Motorrades jedoch ungültig werden, was bedeutet, dass Sie damit nicht mehr auf öffentlichen Straßen fahren dürfen.

Wenden Sie sich daher im Zweifelsfall an Ihren Vertragshändler MV Agusta, bevor Sie entscheiden, welches Zubehör für Ihre Erfordernisse geeignet ist.

2.4. FAHRZEUGBELADUNG

Das Motorrad wurde zum Einsatz des Fahrers und höchstens eines Beifahrers entworfen.

Für einen sicheren Einsatz und unter Berücksichtigung der Straßenverkehrsvorschriften müssen die technische Gewichtswert, die hier unten angegeben ist, nie überschritten werden:

BRUTALE 910 S

Maximales Gesamtgewicht **370 kg**

Maximallastgewicht **180 kg**

Das maximale Gesamtgewicht ist die Summe der folgenden Gewichte, gemäß der Richtlinien CEE 92/61:

- Motorradgewicht;
- Fahrergewicht;
- Beifahrergewicht;
- Ladegewicht und das der Zubehörteile.

**ACHTUNG**

Da das Gewicht einen enormen Einfluss auf die Lenkbarkeit, die Bremsleistung, die Fahrzeugeigenschaften und die Fahrzeugsicherheit hat, müssen die folgenden Vorschriften stets eingehalten werden.

- **DAS MOTORRAD NIE ÜBERLADEN!**
Ein überladenes Motorrad kann die Reifen beschädigen, zu einem Kontrollverlust und schweren Unfällen führen. Überprüfen, dass das Gesamtgewicht mit Fahrer, Beifahrer, Gepäck und Zubehör das zulässige Fahrzeug-Gesamtgewicht nicht überschreitet.



3.1. Anbringung der Bedienelemente und Instrumente

DE
3

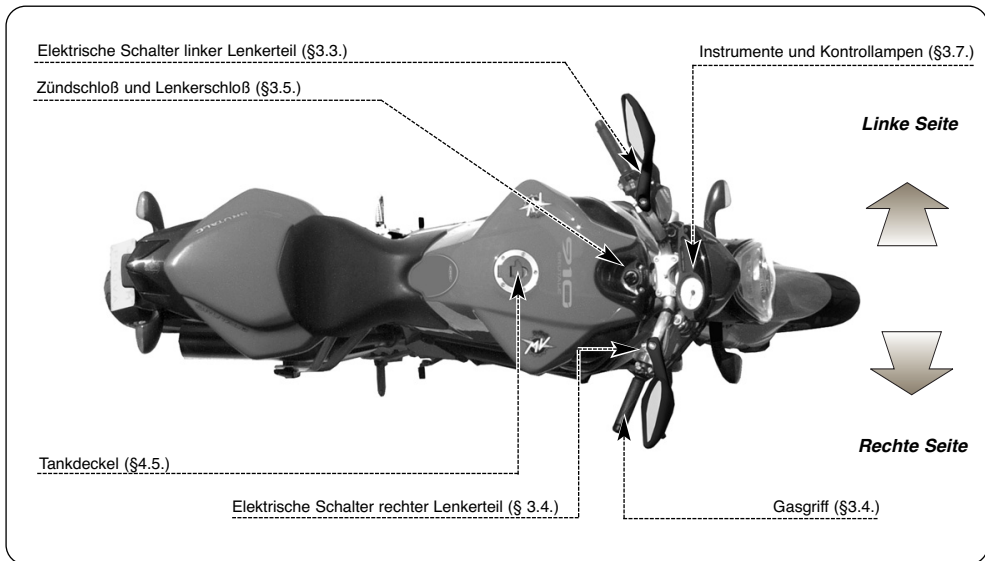



BEDIENUNGSELEMENTE UND INSTRUMENTE 3

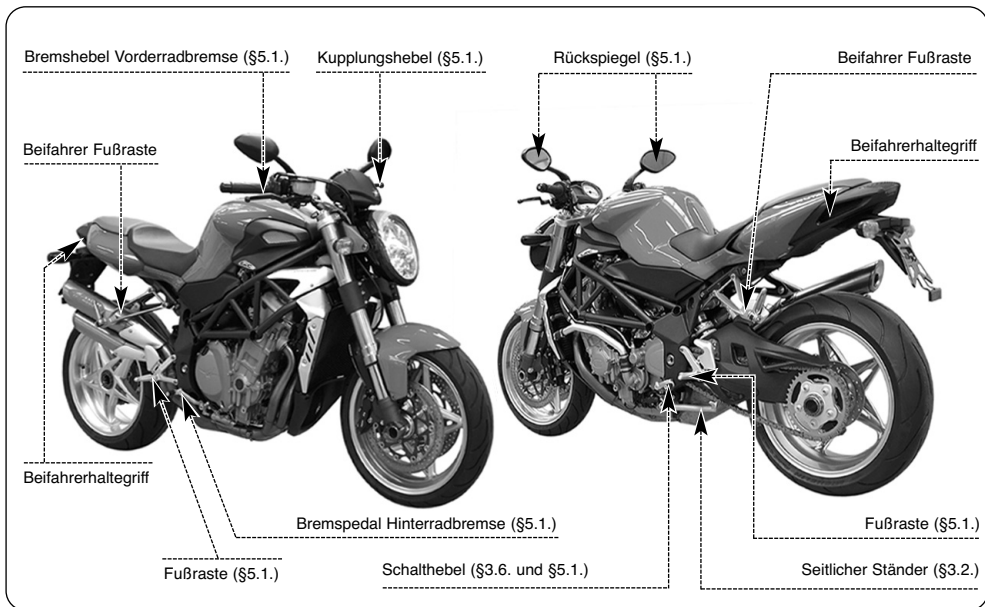

3 DE



3.2. Seitlicher Ständer

Der Seitenständer ist mit einem Sicherheitsschalter (Startfreigabe) ausgerüstet, der ein Losfahren bei runtergeklapptem Seitenständer verhindert.

Ist der Motor bei runtergeklapptem Seitenständer angelassen worden und wird der Kupplungshebel gezogen, um zu Losfahren einen Gang einzulegen, wird die Stromversorgung zum Motor unterbrochen und der Motor stellt sich ab.

Ist der Seitenständer runtergeklappt und gleichzeitig ein Gang eingelegt, verhindert der Schutzschalter, dass der Motor gestartet werden kann. Auf diese Weise wird ein Umfallen des Motorrads vermieden.





3.3. Linke Lenkerschalter

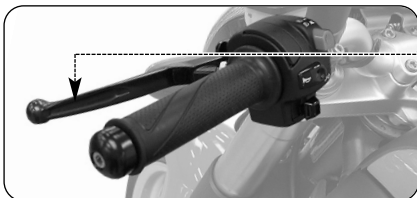

Kupplungshebel

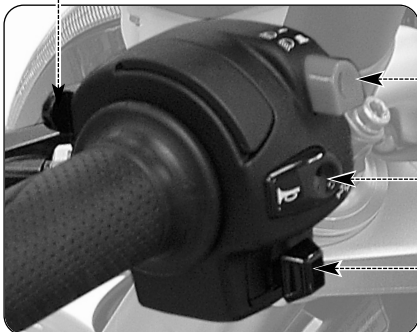

Zur Betätigung der Kupplung den Kupplungshebel ziehen und wieder loslassen.



Druckschalter Lichthupe

Den Schalter mehrmals drücken.

Druckschalter Fernlicht/Fahrlicht

Druckschalter hoch:  Fahrlicht
Druckschalter tief:  Fernlicht

Hupenschalter

Zur Betätigung der Hupe den Schalter drücken.

Blinkerschalter

Bei Verstellen des Hebels nach rechts oder links werden jeweils die rechten oder linken Blinker eingeschaltet. Der Hebel stellt sich auf Mittelstellung zurück. Zum Ausschalten der Blinker auf den Hebel drücken.



Lichthupenschalter

Die Betätigung der Lichthupe durch den Lichthupenschalter dient dazu andere Verkehrsteilnehmer auf sich aufmerksam zu machen oder Gefahren zu signalisieren. Bei eingeschaltetem Fernlicht funktioniert die Lichthupe nicht.

Druckschalter Fernlicht/ Abblendlicht

Schaltet sich normalerweise das Abblendlicht ein. Wenn es der Verkehr und die Straßenführung zulassen, kann mit diesem Druckschalter auf Fernlicht umgeschaltet werden.

Blinkerschalter

Mit diesem Schalter kann anderen Verkehrsteilnehmern ein Fahrtrichtungs- oder Spurwechsel angezeigt werden.



ACHTUNG

Das Nichtbetätigen oder die falsche Betätigung/ das Nichtausschalten des Blinkerschalters kann Unfälle verursachen. Die anderen Verkehrsteilnehmer können dadurch falsche Rückschlüsse auf die tatsächliche Fahrtrichtung ziehen. Vorm Abbiegen oder Spurwechsel stets die Blinker betätigen.

Hupenschalter

Die Betätigung der Hupe durch den Hupenschalter dient dazu andere Verkehrsteilnehmer auf sich aufmerksam zu machen oder Gefahren zu signalisieren.

Kupplungshebel

Mit diesem Hebel wird die Kupplung über eine hydraulische Vorrichtung ein- und ausgekuppelt.



3.4. Rechte Lenkerschalter

Bremshebel Vorderradbremse

Zum Bremsen mit der Vorderradbremse den Bremshebel ziehen.

Gasgriff

Zum Gasgeben den Griff drehen.

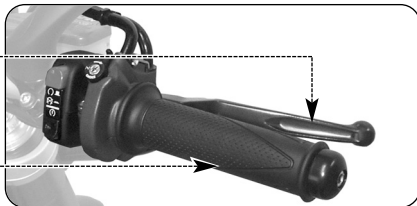

Chokehebel (Kaltstart)

Bei Kaltstart des Motors in Uhrzeigersinn drehen. Nach einigen Sekunden den Hebel in Ausgangsstellung zurückstellen.

Schalter zum Abstellen des Motors

Bei Betätigung wird der Motor abgestellt und kann nicht gestartet werden.

Druckschalter zum Anlassen des Motors

Bei Betätigung wird der Motor gestartet. Sobald der Motor läuft muß der Schalter losgelassen werden. Wird der Schalter bei laufendem Motor erneut betätigt, können die Display-Funktionen ausgewählt werden.

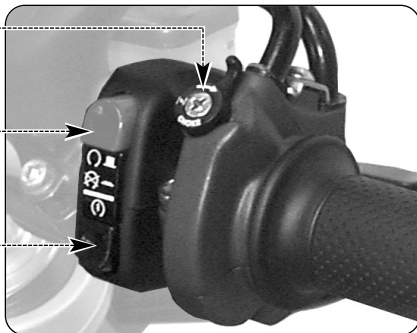



Schalter zum Abstellen des Motors

Mit diesem Schalter kann der Motor in Notfällen abgestellt werden. Wird dieser Schalter betätigt, wird der Zündkreislauf unterbrochen, der Motor kann nicht gestartet werden. Soll der Motor neu gestartet werden, muss vorher dieser Schalter in Ausgangsstellung zurückgestellt werden.

ANMERKUNG

Unter normalen Bedingungen wird dieser Schalter nie zum Abstellen des Motors verwendet.

Druckschalter zum Anlassen des Motors

Mit diesem Schalter wird der Motor gestartet. Bei laufendem Motor können über diesen Schalter die einzelnen Display-Funktionen ausgewählt werden.



VORSICHT

Um Schäden an der elektrischen Anlage zu vermeiden, sollte dieser Schalter bei Startversuchen nie länger als 5 Sekunden gedrückt werden.

Sprint der Motor nach einigen Startversuchen nicht an, siehe Kapitel "STÖRUNGEN" in der vorliegenden Bedienungsanleitung.

Chokehebel (Kaltstart)

Mit dieser Vorrichtung wird der Kaltstart des Motors vereinfacht.

ANMERKUNG

Der Chokehebel sollte nur kurze Zeit und bei der entsprechenden Motor- und Außentemperatur gezogen werden. Reicht die Motordrehzahl aus, um den Motor im Leerlauf laufen zu lassen, sollte der Chokehebel zurückgestellt werden.



Gasgriff

Mit dem Gasgriff wird die Benzinversorgung des Motors geregelt. Zum Gasgeben den Gasgriff aus Ruhestellung (Leerlaufstellung) drehen.

Wird nach einem Kaltstart des Motors (eingeschalteter Choke) der Gasgriff wiederholt in Ruhestellung zurückgedreht, wird der Chokehebel in Ausgangsstellung zurückgestellt.

Bremshebel der Vorderradbremse

Diese Steuerung ermöglicht die Einschaltung des Vorderrad-Bremssystems durch einen hydraulischen Kreislauf.



3.5. Zündschloß und Lenkerschloß



ACHTUNG: Keine Schlüsselanhänger oder anderes am Zündschlüssel anbringen, damit die Lenkerdrehung nicht eingeschränkt wird.



ACHTUNG: Den Zündschlüssel niemals während der Fahrt drehen, Sie könnten sonst die Kontrolle über das Fahrzeug verlieren.

DE
3

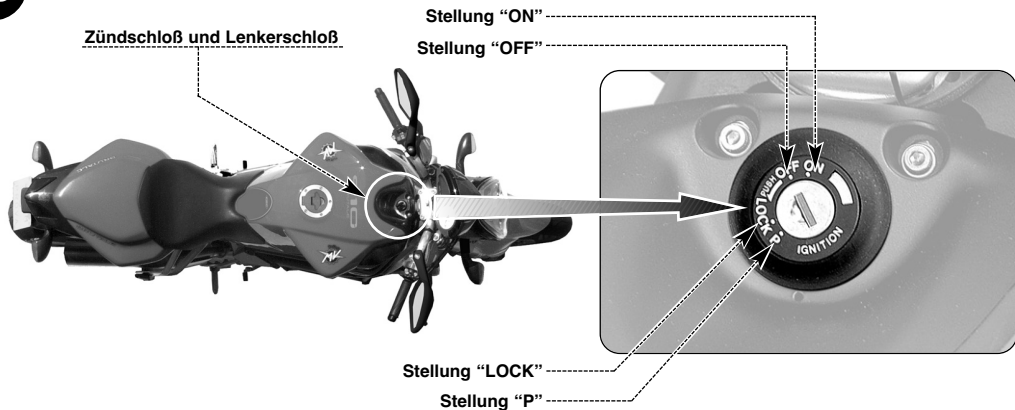



Über das Zündschloß werden der elektrische Kreislauf und das Lenkerschloß ein- bzw. ausgeschaltet. Es gibt folgende vier Stellungen für den Zündschlüssel.

Stellung "OFF"

Alle elektrischen Stromkreise sind ausgeschaltet, der Zündschlüssel kann abgezogen werden.



Stellung "ON"

Alle elektrischen Stromkreise sind eingeschaltet, die Instrumente und Kontrolllampen führen eine Autodiagnose durch, der Motor kann gestartet werden. Der Zündschlüssel kann nicht abgezogen werden.



3 DE



Vorsicht - Vorsichtsmaßnahme: Die Nichteinhaltung der Anweisungen kann schwere und dauerhafte Schäden am Fahrzeug verursachen.



Stellung "LOCK"

Den Lenker nach rechts oder links drehen. Den Schlüssel leicht drücken und auf Stellung "LOCK" drehen. Alle elektrischen Stromkreise sind ausgeschaltet, das Lenkerschloß ist eingearbeitet, der Zündschlüssel kann abgezogen werden.

DE
3

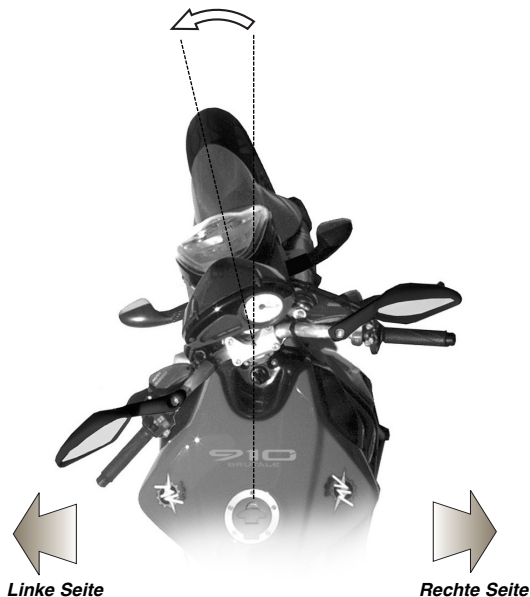



Stellung "P"

Den Schlüssel von Stellung "LOCK" auf Stellung "P" drehen. Alle elektrischen Stromkreise sind mit Ausnahme des Parklichts (Standlichts) ausgeschaltet, das Lenkerschloß ist eingerastet. Der Zündschlüssel kann abgezogen werden.



VORSICHT

Um ein Entladen der Motorradbatterie zu vermeiden, den Schlüssel nicht längere Zeit in Stellung "P" lassen.





3.6. Schaltung

Die Stellung **N** "Neutral" ist die Leerlaufstellung, die auch durch Aufleuchten der entsprechenden Kontrolllampe am Armaturenbrett angezeigt wird.

Durch Drücken nach unten wird der erste Gang eingelegt.

Durch Drücken nach oben wird der zweite Gang, durch weiteres Drücken der dritte Gang usw. bis zum sechsten Gang eingelegt.

DE
3



Schalthebel

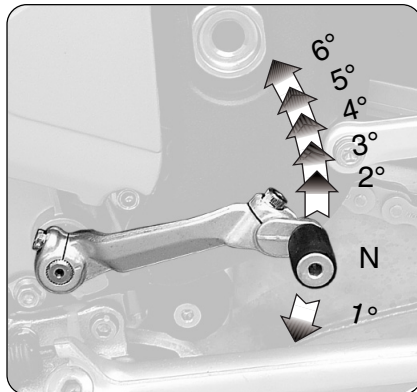



3.7. Instrumente und Kontrolllampen

Die Instrumente und Kontrolllampen werden durch Drehen des Zündschlüssels auf "ON" eingeschaltet. Nach einer ersten Überprüfung (ungefähr 7 Sekunden) zeigen die Instrumente den allgemeinen Zustand des Motorrads in diesem Moment an.

Kontrolllampen
(§3.7.1.)

Druckschalter "SET"
(§3.7.2.)

Multifunktions-Display (§3.7.2.)

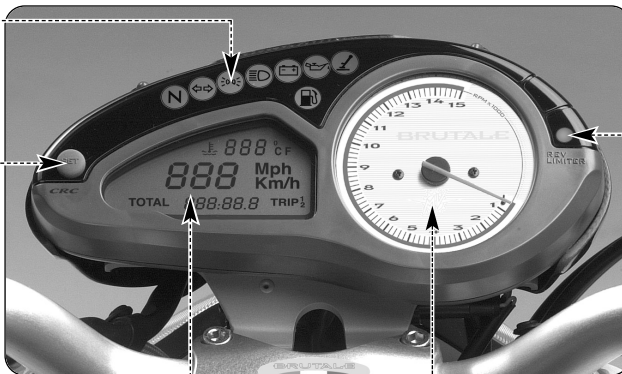

Kontrolllampe
(§3.7.1.)

Drehzahlmesser



3.7.1. Kontrollampen

Fernlichtkontrolle (blau)

Leuchtet auf, wenn das Fernlicht eingeschaltet ist.

Batterieladkontrolle (rot)

Leuchtet auf, wenn die Lichtmaschine nicht ausreichend Strom zum Laden der Batterie liefert.

Leuchtet die Batterieladkontrolle während der Fahrt auf, wenden Sie sich bitte an einen Kundendienst.

Kontrollampe Fahrlicht (grün)

Leuchtet auf, wenn Fahrlicht eingeschaltet sind.

Kontrolle ausgeklappter Seitenständer (rot)

Leuchtet auf, wenn der Seitenständer ausgeklappt ist.

Kontrollampe Leerlauf (grün)

Leuchtet auf, wenn sich der Schalthebel in Leerlaufstellung "Neutral" befindet.

Kontrollampe Drehzahlbegrenzung (rot)

Leuchtet auf, wenn die Motordrehzahl über 11300 U/min liegt. Die Drehzahlbegrenzung schaltet sich ab 12000 U/min ein.

Blinkerkontrolle (grün)

Leuchtet auf, wenn die Blinker eingeschaltet sind.

Kontrollampe Motoröldruck (rot)

Leuchtet bei unzureichendem Motoröldruck auf.



Gefahr - Achtung: Wenn diese Kontrollampe während der Fahrt aufleuchtet, sofort anhalten, den Motorölstand überprüfen und läß durch eine MV Agusta-Kundendienst Motoröl nachfüllen (siehe §3.8.). Leuchtet die Kontrollampe trotz ausreichendem Motorölstand weiterhin auf, nicht weiterfahren und einen MV Agusta-Kundendienst rufen.

Benzinreserve (orange)

Leuchtet auf, wenn die 4-Liter Reserve im Tank erreicht ist.

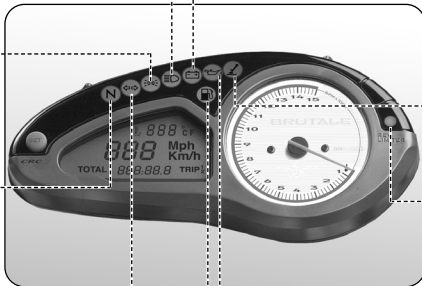



3.7.2. Multifunktions-Display

Tachometer

Zeigt die Geschwindigkeit an. Die Geschwindigkeit kann in Kilometer pro Stunde (km/h) oder Meilen pro Stunde (Mph) angezeigt werden. Die Tachometerskala reicht bis 299 km/h (186 Mph).

Druckschalter "SET"

Durch Drücken können die Ziffern am Display eingestellt werden. Durch erneutes Drücken wird die Eingabe bestätigt.

Kilometerzähler "TOTAL"

Zeigt die gesamten gefahrenen Kilometer an; von 0 bis 99999,9 (km oder mile)

Tageskilometerzähler "TRIP 1"

Zeigt die gefahrenen Kilometer einer Teilstrecke an; von 0 bis 9999,9 (km oder mile)

Tageskilometerzähler "TRIP 2"

Zeigt die gefahrenen Kilometer einer Teilstrecke an; von 0 bis 9999,9 (km oder mile)

Uhr zeigt die Uhrzeit an (0 - 24)

Thermometer

Zeigt die Temperatur der Kühlflüssigkeit an. Die Temperatur kann in °C oder in °F angezeigt werden.

Der Anzeigebereich liegt zwischen 40° und 140°C (104° und 284°F):

- Temperaturen unter 40°C (104°F) werden nicht angezeigt, es erscheinen drei blinkende Linien, die niedrige Temperatur anzeigen.

- Zwischen 50° und 111°C (122° und 232°F) ist die Anzeige konstant.

- Zwischen 112° und 140°C (234° und 284°F) blinkt die Anzeige, das ist die Warnung vor hoher Temperatur.

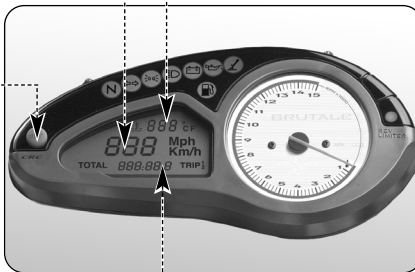

Gefahr - Achtung: Bei Temperaturen von mehr als 120°C (248°F) das Motorrad anhalten, den Motor abstellen und den Kühlflüssigkeitsstand überprüfen. Muss Kühlflüssigkeit nachgefüllt werden, den MV Agusta-Kundendienst benachrichtigen (siehe §3.8.). Leuchtet die Anzeige trotz richtigem Kühlflüssigkeitsstand auf, nicht weiterfahren und einen MV Agusta-Kundendienst rufen.



3.8. Schmiermitteltabelle

Beschreibung	Empfohlenes Produkt	Technische Angaben
Motoröl	AGIP RACING 4T 10W/60 (*)	SAE 10W/60 - API SJ
Kühlflüssigkeit	AGIP ECO - PERMANENT	Glykolethylen mit 50% destilliertem Wasser verdünnt
Brems- und Kupplungsflüssigkeit	AGIP BRAKE FLUID DOT4	DOT4
Kettenöl	MOTUL CHAIN LUBE ROAD	-

* : Damit Sie die empfohlenen Produkte finden und kaufen können, empfiehlt Ihnen MV Agusta sich direkt an die autorisierten Vertragshändler zu wenden. Das Motoröl AGIP Racing 4T 10W/60 wurde speziell für den Motor des Motorrads F4 entwickelt. Steht das empfohlene Schmiermittel nicht zu Verfügung, rät MV Agusta zum Gebrauch vollständig synthetischer Öle, die die gleichen oder bessere Eigenschaften als folgende Normen haben:

- Konform API SJ
- Konform ACEA A3
- Konform JASO MA
- Grad SAE 20 W-50 oder 10 W-60

ANMERKUNG

Die o. a. Spezifizierungen müssen entweder allein oder zusammen mit anderen auf dem Behälter des Motoröl aufgedruckt sein.





4.1. Einsatz des Motorrads

In diesem Abschnitt werden die wichtigsten Themen für einen richtigen Einsatz des Motorrads behandelt.



ACHTUNG

Das F4 BRUTALE 910 S Motorrad zeigt hohe Leistungsmerkmale. Für sein Gebrauch wird ein ausreichendes Niveau des Wissens des Fahrzeugs angefordert. Wenn Sie dieses Motorrad zum ersten Mal benutzen, ist es notwendig, eine vorsichtige Haltung anzunehmen. Eine konkurrenzfähige Ridinghaltung kann die Gefahr der Unfälle erhöhen, welche die Sicherheit des Treibers und der Leute gefährden.



ACHTUNG

DIE BESCHRÄNKUNGEN FÜR DIE ERLAUBTE NUTZUNG DES FAHRZEUGES FINDEN SIE IM ABSCHNITT "SICHERHEITSINFORMATIONEN".



4.2. Einfahren



Vorsicht - Vorsichtsmaßnahme: Die Nichteinhaltung der Anweisungen kann schwere und dauerhafte Schäden am Fahrzeug verursachen.

Normalerweise denkt man beim Einfahren nur an den Motor. Tatsächlich muß die Einfahrzeit auch für andere wichtige Motorradteile berücksichtigt werden. Dies gilt besonders für die Reifen, die Bremsen, die Antriebskette usw. Die ersten Kilometer müssen besonders langsam und ruhig gefahren werden.

□ Von 0 bis 500 km (von 0 bis 300 mile) (A)

In dieser ersten Einfahrphase sollte die Motordrehzahl häufig geändert werden. Möglichst auf leicht hügeligen und kurvenreichen Strecken fahren und lange grade Strecken vermeiden.

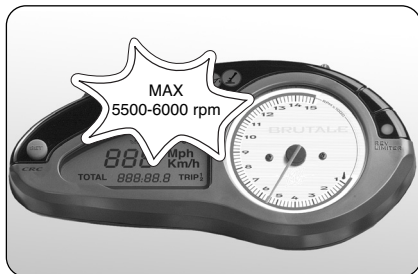

ACHTUNG: Neue Reifen müssen auf geeignete Weise eingefahren werden, so dass sie ihre komplette Effizienz erhalten. Während der ersten 100 km sollte ein Anfahren bei Vollgas, schnelle Kurvenfahrten und Vollbremsungen vermieden werden. Wird der Einfahrzeitraum nicht beachtet, besteht Schleuderoder Unfallgefahr, weil die Kontrolle über das Fahrzeug verloren gehen kann.



□ Von 500 bis 1000 km (von 300 bis 600 mile)

In dieser Phase Vollgas vermeiden und nie über lange Strecken mit konstanter Geschwindigkeit fahren.

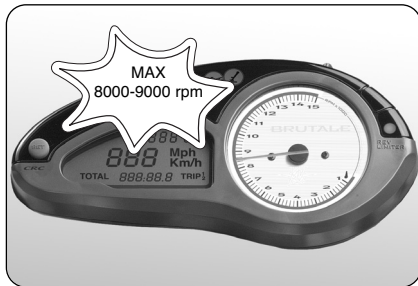

□ Von 1000 bis 2500 km (von 600 bis 1600 mile)

Das Motorrad kann jetzt stärker beansprucht werden. Trotzdem sollte die angegebene Motordrehzahl nicht überschritten werden.

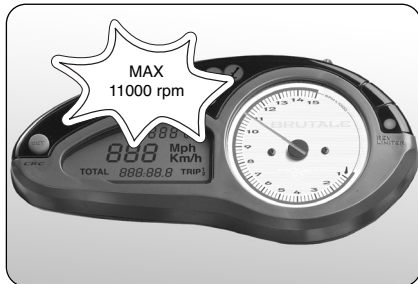



4.3. Starten des Motors



ACHTUNG

Niemals den Motor in geschlossenen Räumen laufen lassen. Vergiftungsgefahr! Die Abgase enthalten Kohlenmonoxyd, ein farb- und geruchloses Gas, dessen Einatmen zu schweren Vergiftungen oder zum Tod führen kann. Den Motor nur im Freien laufen lassen.

► Wird der Zündschlüssel auf "ON" gedreht, führen die Instrumente und Kontrolllampen eine Autodiagnose durch. Überprüfen Sie während dieser Phase, dass alle Kontrolllampen am Armaturenbrett aufleuchten. Damit der Zündkreislauf-Unterbrechungssystem den Start freigibt, muss einer der folgenden Voraussetzungen erfüllt sein:

- Der Schalthebel muss auf Leerlaufstellung stehen.
- Ein Gang ist eingelegt, gleichzeitig ist der Kupplungshebel gezogen, der Seitenständer ist hochgeklappt.

Kaltstart

► Den "CHOKE" Hebel drehen, ohne dabei den Gasgriff zu drehen, und den Anlasserschalter drücken.





► Sobald der Motor angesprungen ist, den Anlasserschalter loslassen. Nach kurzem Warmlaufen des Motors den Chokehebel in Ausgangsstellung zurückstellen.

☐ Warmstart

► Den Anlasserschalter drücken, ohne dabei den Gasgriff zu drehen.

► Sobald der Motor gestartet ist, den Anlasserschalter loslassen.



Vorsicht – Vorsichtsmassnahme

- Um Schäden an der Elektroanlage zu vermeiden, den Anlasserschalter nie länger als 5 Sekunden gedrückt halten.
- Den Motor nicht lange im Stand laufen lassen. Der Motor kann sich dabei überhitzen und Motorbauteile beschädigen. Der Motor sollte durch langsames Fahren auf Betriebstemperatur gebracht werden.
- Bei kaltem Motor kein Vollgas geben, der Motor hält dann wesentlich länger.





4.4. Auswahl und Modifizieren der Display-Funktionen

Am Instrument können einige wichtige Messparameter geändert und die Chronometerfunktion eingestellt werden.

Folgendes kann eingestellt bzw. ausgewählt werden:

- Auswahl folgender Funktionen:

Kilometerzähler Gesamtkilometer "TOTAL"
Kilometerzähler Tageskilometer 1 "TRIP 1"
Kilometerzähler Tageskilometer 2 "TRIP 2"
Uhrzeit

- Maßeinheiten können eingestellt werden für:

Geschwindigkeit
Fahrstrecke
Temperatur

- Nullstellen der Tageskilometeranzeige:

Kilometerzähler Tageskilometer 1 "TRIP 1"
Kilometerzähler Tageskilometer 2 "TRIP 2"

- Einstellen der Uhrzeit





4.4.1. Auswahl der Display-Funktionen

Die Auswahl betrifft die Funktionen des:

- Kilometerzählers "TOTAL"
- Tageskilometerzähler 1 "TRIP 1"
- Tageskilometerzähler 2 "TRIP 2"
- Uhr

► Durch Drücken des Anlasserschalters werden nacheinander die Funktionen "TOTAL", "TRIP1" und "TRIP2" angezeigt. Die gewünschte Anzeige auswählen.



4 DE



ACHTUNG

Änderungen oder Einstellung der Display-Funktionen müssen bei laufendem Motor, eingelegtem Leerlauf, angehaltenem Motorrad und beiden Füßen auf der Erde vorgenommen werden. Einstellungen am Display während der Fahrt zu ändern ist verboten.



4.4.2. Einstellen des Maßeinheiten

Es besteht die Möglichkeit die Maßeinheiten zu ändern.



ACHTUNG: Änderungen oder Einstellung der Display-Funktionen müssen bei laufendem Motor, eingelegtem Leerlauf, angehaltenem Motorrad und beiden Füßen auf der Erde vorgenommen werden.

Einstellungen am Display während der Fahrt zu ändern ist verboten.



□ Tachometer (km/h - Mph)

▶ Den Anlasserschalter mehrfach drücken, bis der Gesamt-Kilometerzähler "TOTAL" angezeigt wird.

▶ Den Druckschalter "SET" drücken, die Maßeinheit des Tachometers beginnt zu blinken.





► Den Anlasserschalter drücken, um von km/h auf Mph oder umgekehrt umzuschalten. Wird die Maßeinheit am Tachometer verändert, ändert sich automatisch auch die Maßeinheit am Kilometerzähler (Gesamtkilometer und Tageskilometer).

Beachten: 1 mi = 1,609 km

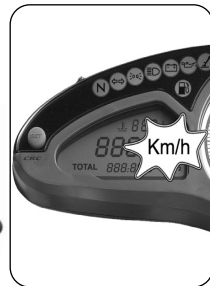

4 DE

► Den Druckschalter "SET" zur Bestätigung der Änderung der Maßeinheit am Tachometer drücken. Anschließend beginnt die Maßeinheit der Temperaturanzeige zu blinken. Jetzt kann die nächste Änderung vorgenommen werden.





□ Thermometer (°C - °F)

► Den Anlasserschalter drücken, um von °C auf °F oder umgekehrt umzuschalten.

Beachten: $T (°F) = 1,8 \cdot t (°C) + 32$

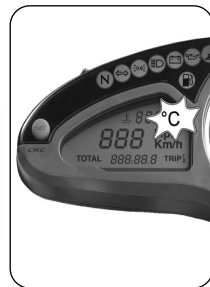

► Den Druckschalter "SET" zur Bestätigung der Änderung der Maßeinheit am Thermometer drücken.





4.4.3. Nullstellen der Tageskilometerzähler

Die Anzeigen des Tageskilometerzählers "TRIP1" und des Tageskilometerzählers "TRIP2" können folgendermaßen auf Null zurückgestellt werden.



ACHTUNG

Änderungen oder Einstellung der Display-Funktionen müssen bei laufendem Motor, eingelegetem Leerlauf, angehaltenem Motorrad und beiden Füßen auf der Erde vorgenommen werden. Einstellungen am Display während der Fahrt zu ändern ist verboten.

► Durch Drücken des Anlasserschalters die Funktion "TRIP1" einschalten.

► Wird der Anlasserschalter länger als 4 Sekunden gedrückt gehalten; der Wert "TRIP 1" fängt an zu blinken.

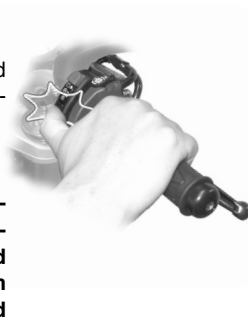



► Wird der Anlasserschalter kürzer als 4 Sekunden gedrückt, wird der angezeigte Wert am Display auf Null zurückgestellt. Wird der Anlasserschalter hingegen länger als 4 Sekunden gedrückt gehalten, wird das Nullstellen abgebrochen.



► Durch Drücken des Anlasserschalters die Funktion "TRIP2" einschalten.





► Wird der Anlasserschalter länger als 4 Sekunden gedrückt gehalten; der Wert "TRIP 2" fängt an zu blinken.



► Wird der Anlasserschalter kürzer als 4 Sekunden gedrückt, wird der angezeigte Wert am Display auf Null zurückgestellt. Wird der Anlasserschalter hingegen länger als 4 Sekunden gedrückt gehalten, wird das Nullstellen abgebrochen.





4.4.4. Einstellen der Uhrzeit

Die Uhrzeit kann wie folgt eingestellt werden.



ACHTUNG: Änderungen oder Einstellung der Display-Funktionen müssen bei laufendem Motor, eingelegtem Leerlauf, angehaltenem Motorrad und beiden Füßen auf der Erde vorgenommen werden.

Einstellungen am Display während der Fahrt zu ändern ist verboten.



► Den Anlasserschalter mehrfach drücken, bis die Uhrzeit angezeigt wird.

► Den Druckschalter "SET" drücken, die erste Ziffer der Stundenanzeige beginnt zu blinken.





- ▶ Den Druckschalter drücken und loslassen, sobald die gewünschte Ziffer erreicht ist.

ANMERKUNG

Zum Schnelldurchlauf der Ziffern den Anlasserschalter länger als 2 Sekunden gedrückt halten.

- ▶ Zur Bestätigung der Eingabe den Schalter "SET" drücken. und mit der Einstellung der zweiten Ziffer weitermachen.

- ▶ Die gleiche Vorgehensweise wie oben gilt für die zweite Ziffer sowie die erste und zweite Ziffer der Minutenanzeige.

- ▶ Zur Bestätigung der Uhrzeiteinstellung oder zum Abbrechen (Blinken) den Schalter "SET" drücken.

ANMERKUNG

Die Instrumentenausstattung hat einen integrierten Speicher, der alle Parameter auch bei ausgeschaltetem Motor speichert. Beim Abklemmen der Batterie wird dieser Speicher nicht gelöscht, in diesem Fall wird nur die Uhrzeit auf Null zurückgestellt.

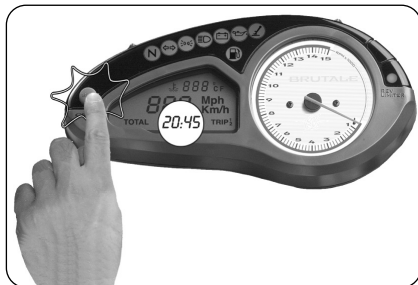



4.5. Tanken



Gefahr - Achtung: Benzin und Benzindämpfe sind leicht entzündbar und giftig. Kontakt mit Benzin und Einatmen vermeiden. Beim Tanken den Motor abschalten und nicht rauchen, offene Flammen und Hitzequellen fernhalten. Im Freien oder in gut belüfteten Räumen tanken.



Vorsicht - Vorsichtsmassnahme: Ausschließlich bleifreies Superbenzin mit einer Oktanzahl (R.O.N.) von 95 oder mehr tanken. Auf die Notwendigkeit bleifreies Benzin zu tanken, werden Sie durch den grünen Punkt, der auf der Unterseite des Tankdeckels angebracht ist.

- ▶ Den Staubschutzdeckel anheben.
- ▶ Den Schlüssel einstecken und in Uhrzeigersinn drehen.

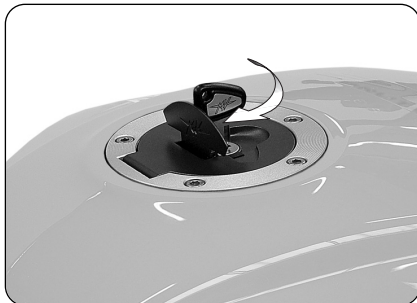
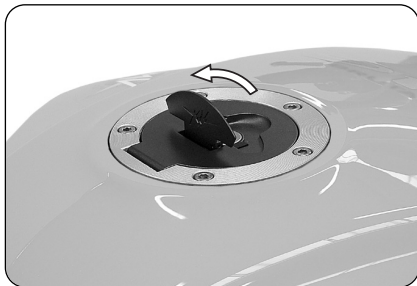



► Den Einfüllstopfen abnehmen und mit Benzin tanken.

**ACHTUNG**

Wird der Tank bis zum Rand gefüllt, kann Benzin austreten, das sich durch Sonneneinwirkung oder die Motorwärme ausdehnen kann. Bei austretendem Benzin besteht Brandgefahr. Der Benzinstand darf nie über dem Ende des Einfüllstutzens stehen.

► Nach dem Tanken den Tankdeckel nach unten drücken und gleichzeitig den Schlüssel in Uhrzeigersinn drehen. Den Schlüssel loslassen und abziehen.



Vorsicht - Vorsichtsmassnahme: Eventuelle ausgetropftes Benzin sofort mit einem sauberen Lappen abwischen, andernfalls können Lack oder Plastikteile beschädigt werden.

**ACHTUNG**

Vorm Losfahren prüfen, ob der Tankdeckel richtig verschlossen ist.

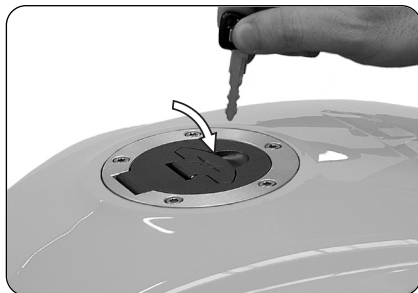
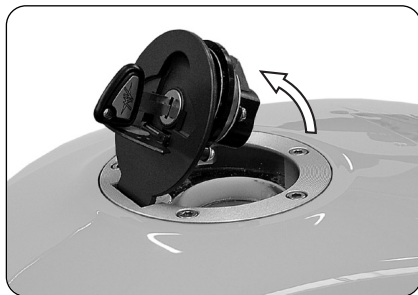



4.6. Zugang zum Staufach

► Den Schlüssel ins Schloss einstecken.

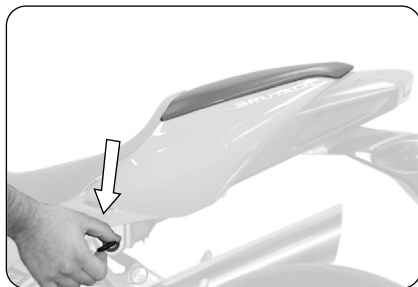

► Den Schlüssel in Uhrzeigersinn drehen und gleichzeitig leicht auf den Beifahrersitz drücken. Den Sitz aufheben.





► Den Beifahrersitz herausnehmen.

Zum Wiederausammensetzung des Beifahrersitzes sind folgende Punkte zu berücksichtigen:

- Den Schlüssel im Schloss drehen
- Den Beifahrersitz nach unten drücken
- Den Schlüssel loslassen
- Den Beifahrersitz wiederum nach unten drücken und nachprüfen ob er an der Struktur fest befestigt ist.



ACHTUNG

Nach Demontage oder Abhebung des Beifahrersitzes und vor jedem Motorrad Einsatz muss man sich vergewissern, dass dieser Bauteil korrekt angebracht und an der Tragstruktur des Fahrzeuges gut befestigt ist.



4.7. Parken des Motorrads

□ Parken auf dem Seitenständer



ACHTUNG: Das Motorrad stets sicher auf festem Untergrund abstellen. Beim Parken auf abschüssigem Gelände das Vorderrad bergauf stellen und den ersten Gang einlegen. Vorm Starten muss wieder der Leerlauf eingelegt werden. Niemals den Zündschlüssel stecken lassen, wenn das Fahrzeug unbeaufsichtigt ist. Wird das Motorrad zum Parken auf den Seitenständer gestellt, ist es gefährlich

- ▶ Den Seitenständer mit dem Fuß bis zum Anschlag ausklappen und das Motorrad langsam neigen, bis der Ständerfuß auf dem Untergrund fest aufliegt.

sich auf das Fahrzeug zu setzen, da das gesamte Gewicht nur auf dem Seitenständer aufliegt. Vorm Losfahren die Funktion des Sicherheitsschalters prüfen. Die Kontrolllampe am Armaturenbrett für den abgeklappten Seitenständer muss sich ausschalten. Auf jeden Fall prüfen, dass der Seitenständer richtig hochgeklappt ist. Wird eine Störung bemerkt, muss die Anlage vor Fahrtantritt bei einem MV Agusta Vertragshändler überprüft werden.

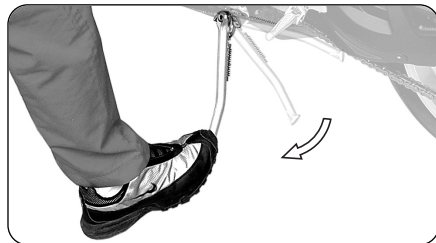



□ Parken auf dem hinteren Ständer

Den Zapfen des Ständer von der linken Fahrzeugseite aus in die Öffnung an der Radachse stecken. Den Ständer auf den Boden stellen, festhalten und das Fahrzeug soweit anheben, bis es sicher steht.



ACHTUNG

Dieser Vorgang muss von zwei Personen zusammen ausgeführt werden.

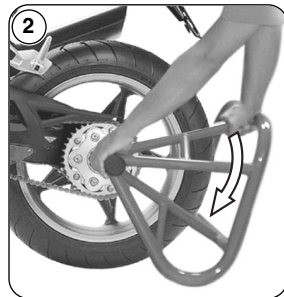
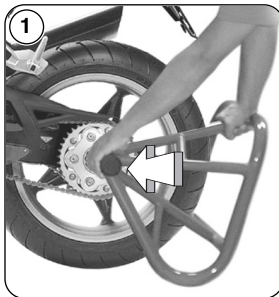



5.1. Liste der Einstellungsarbeiten

Das Motorrad bietet eine breite Auswahl von Einstellungsmöglichkeiten, die Ergonomie, die Sitzposition und die Sicherheit verbessern können.

Da eine falsche Einstellung von wichtigen Komponenten eine Gefahrenquelle darstellen kann, dürfen einige dieser Einstellungen nur von einer MV Agusta-Vertragswerkstatt vorgenommen werden.



ACHTUNG

Alle Einstellungsarbeiten müssen bei stehendem Fahrzeug vorgenommen werden.



(F) Einstellung Rückspiegel (§5.5.)

(A) Einstellung Bremshebel Vorderradbremse (§5.3.)

(C) Einstellung rechte Fußraste (§5.2.)

(H) Einstellung hintere Federung (§5.7.)

(E) Einstellung Bremspedal Hinterradbremse (§5.2.)

(G) Einstellung vordere Federung (§5.6.)

(M) Einstellung Scheinwerfer (§5.8.)

(G) Einstellung vordere Federung (§5.6.)

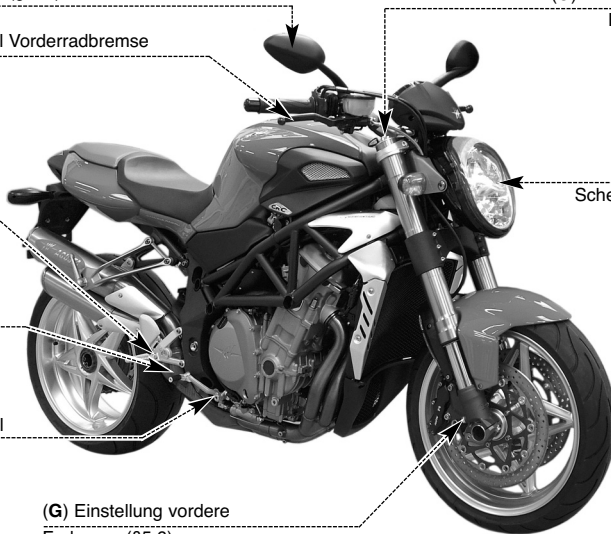



(F) Einstellung Rückspiegel (§5.5.)

(H) Einstellung hintere Federung (§5.7.)

(B) Einstellung
Kupplungshebel (§5.4.)

(D) Einstellung
Schaltpedal (§5.2.)

(C) Einstellung linke Fußraste (§5.2.)

(L) Einstellung
Kette (§5.2.)





5.2. Tabelle der Einstellungsarbeiten

	A - Einstellung Bremshebel Vorderradbremse: Bessere Einstellung des Bremshebels auf die persönlichen Anforderungen des Fahrers (§5.3).		G - Einstellung vordere Federung: um die Federung an den persönlichen Fahrstil anzupassen, gibt es folgende Einstellmöglichkeiten: <ul style="list-style-type: none">- Federvorspannung (§5.6.1.)- Hydraulische Ausdehnungsbremse (§5.6.2.)- Hydraulische Kompressionsbremse (§5.6.3.)
	B - Einstellung Kupplungshebel: Bessere Einstellung des Kupplungshebels auf die persönlichen Anforderungen des Fahrers (§5.4).		H - Einstellung hintere Federung: um die Federung an den persönlichen Fahrstil anzupassen, gibt es folgende Einstellmöglichkeiten: <ul style="list-style-type: none">- Federvorspannung- Höhe Sitzposition
	C - Einstellung der Fußrasten (rechts und links): Bessere Einstellung der Fußrasten auf die persönlichen Anforderungen des Fahrers.		<ul style="list-style-type: none">- Hydraulische Ausdehnungsbremse (§5.7.1.)- Hydraulische Kompressionsbremse - Hohe Gänge (§5.7.2.)- Hydraulische Kompressionsbremse - Niedrige Gänge (§5.7.3.)
	D - Einstellung Schaltpedal: Bessere Einstellung des Schaltpedals auf die persönlichen Anforderungen des Fahrers.		L - Einstellung Kette: Für Funktion und Sicherheit des Antriebs.
	E - Einstellung Bremspedal Hinterradbremse: Bessere Einstellung des Bremspedals auf die persönlichen Anforderungen des Fahrers.		M - Einstellung Scheinwerfer: Um den Lichtstrahl des Scheinwerfers entsprechend der Sitzposition einzustellen (§5.8).
	F - Einstellung Rückspiegel: Zur besseren Einstellung (§5.5). ACHTUNG: Die Befestigungsschraube des Lenkerrückspiegels nie ausschrauben. Falls notwendig wenden Sie sich bitte nur einem MV Agusta-Händler.		



5.3. Einstellung Bremshebel Vorderradbremse

Den Hebel ziehen, um den Federdruck auszugleichen. Gleichzeitig die Hebelposition durch Drehen der Nutmutter einstellen. Drehen in Uhrzeigersinn: der Hebel entfernt sich vom Handgriff. Drehen gegen den Uhrzeigersinn: der Hebel nähert sich an den Handgriff an.

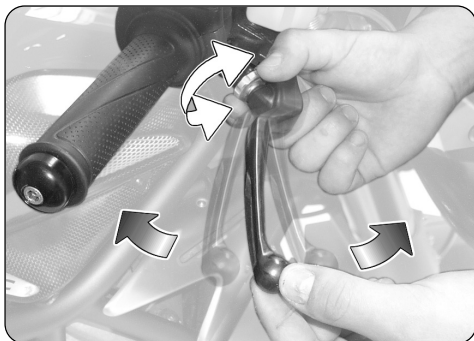

5.4. Einstellung Kupplungshebel

Den Hebel ziehen, um den Federdruck auszugleichen. Gleichzeitig die Hebelposition durch Drehen der Nutmutter einstellen. Drehen in Uhrzeigersinn: der Hebel entfernt sich vom Handgriff. Drehen gegen den Uhrzeigersinn: der Hebel nähert sich an den Handgriff an.





5.5. Einstellung Rückspiegel

Zur Einstellung des Rückspiegels an den vier in der Abbildung gezeigten Stellen drücken.

Die Einstellung beider Rückspiegel durchführen. Zur Durchführung einer korrekten Rückspiegeleinstellung ist es ratsam auf das Motorrad zu steigen.

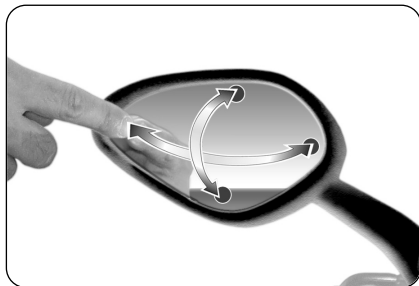



5.6. Einstellung vordere Federung



ACHTUNG: Die Einstellvorrichtungen müssen an beiden Gabelbeinen gleich eingestellt werden.

ANMERKUNG: Die Einstellung der Federungen muß vorzugsweise mit dem Benzintank volle durchgeführt werden.

Hydraulische
Ausdehnungsbremse
Federvorspannung

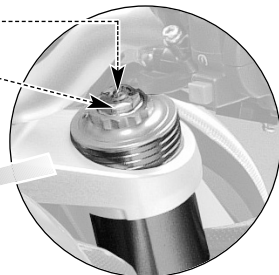

Hydraulische
Kompressionsbremse

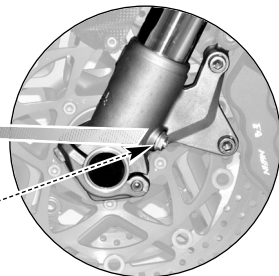



5.6.1. Federvorspannung

Für die Einstellungsarbeiten muß von der Standardeinstellung ausgegangen werden. Um die Standardeinstellung zu erreichen, gegen den Uhrzeigersinn bis zum Anschlag drehen, anschließend in Uhrzeigersinn bis Standardposition (siehe Tabelle) drehen. In Uhrzeigersinn drehen um die Federvorspannung zu erhöhen, gegen den Uhrzeigersinn drehen, um die Federvorspannung abzuschwächen.



5.6.2. Hydraulische Ausdehnungsbremse (Vorderradfederung)

Für die Einstellungsarbeiten muß von der Standardeinstellung ausgegangen werden. Um die Standardeinstellung zu erreichen, in Uhrzeigersinn bis zum Anschlag drehen, anschließend gegen den Uhrzeigersinn bis Standardposition (siehe Tabelle) drehen. In Uhrzeigersinn drehen um die Bremsleistung zu erhöhen, gegen den Uhrzeigersinn drehen, um die Bremsleistung abzuschwächen.





5.6.3. Hydraulische Kompressionsbremse (Vorderadfederung)

Für die Einstellungsarbeiten muß von der Standardeinstellung ausgegangen werden. Um die Standardeinstellung zu erreichen, in Uhrzeigersinn bis zum Anschlag drehen, anschließend gegen den Uhrzeigersinn bis Standardposition (siehe Tabelle) drehen. In Uhrzeigersinn drehen um die Bremsleistung zu erhöhen, gegen den Uhrzeigersinn drehen, um die Bremsleistung abzuschwächen.

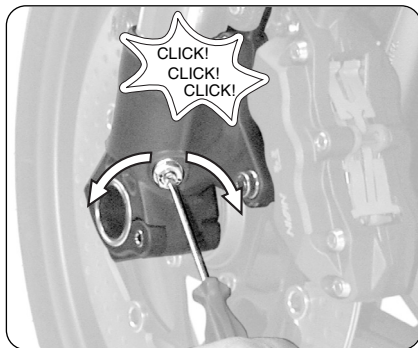



5.7. Einstellung hintere Federung



Gefahr - Achtung: Die Auspuffrohre sind heiß - Verbrennungsgefahr. Den Motor ausschalten und vor der Einstellung abwarten, bis die Auspuffrohre abgekühlt sind.

ANMERKUNG: Die Einstellung der Federungen muß vorzugsweise mit dem Benzintank volle durchgeführt werden.



Hydraulische Kompressionsbremse
(für hohe Gänge und niedrige Gänge)

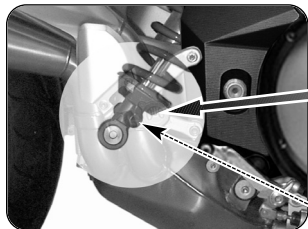

Hydraulische Ausdehnungsbremse



5.7.1. Hydraulische Ausdehnungsbremse (Hinterradfederung)

Die Einstellung wird bei Betätigung der Schraube, die sich im Unterteil des Stoßdämpfers befindet, ausgehend von der Standardposition, durchgeführt.

Um die Standardeinstellung zu erreichen, in Uhrzeigersinn bis zum Anschlag drehen, anschließend gegen den Uhrzeigersinn bis Standardposition (siehe Tabelle) drehen.

In Uhrzeigersinn drehen um die Bremsleistung zu erhöhen, gegen den Uhrzeigersinn drehen, um die Bremsleistung abzuschwächen.

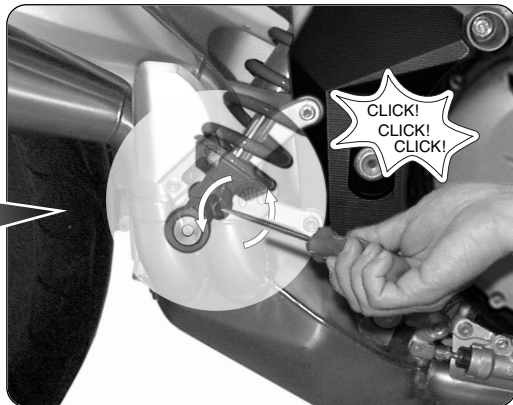
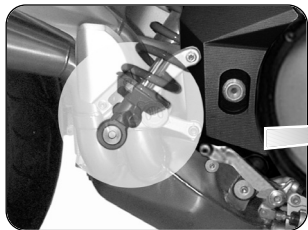



5.7.2. Hydraulische Kompressionsbremse für hohe Gänge (Hinterradfederung)

Die Einstellung wird bei Betätigung der Mutter, die sich im Oberteil des Stoßdämpfers befindet, ausgehend von der Standardposition, durchgeführt. Um die Standardeinstellung zu erreichen, gegen den Uhrzeigersinn bis zum Anschlag drehen, anschließend in Uhrzeigersinn bis Standardposition (siehe Tabelle) drehen. In Uhrzeigersinn drehen um die Bremsleistung zu erhöhen, gegen den Uhrzeigersinn drehen, um die Bremsleistung abzuschwächen.



5.7.3. Hydraulische Kompressionsbremse für niedrige Gänge (Hinterradfederung)

Die Einstellung wird bei Betätigung der Schraube, die sich im Oberteil des Stoßdämpfers befindet, ausgehend von der Standardposition, durchgeführt. Um die Standardeinstellung zu erreichen, in Uhrzeigersinn bis zum Anschlag drehen, anschließend gegen den Uhrzeigersinn bis Standardposition (siehe Tabelle) drehen. In Uhrzeigersinn drehen um die Bremsleistung zu erhöhen, gegen den Uhrzeigersinn drehen, um die Bremsleistung abzuschwächen.





5.8. Scheinwerfereinstellung

Das Fahrzeug auf ebenem Untergrund in einem Abstand von 10 m vor eine Wand stellen. Das Fahrzeug muss aufrecht senkrecht zur Wand stehen. Den Abstand zwischen Scheinwerfermitte und Boden messen. Den Wert an der Wand mit einem Kreuz anzeichnen. Den Scheinwerfer einschalten und Fahrlicht einstellen. Den Lichtstrahl so einstellen, dass sich die Hell-Dunkel-Linie $9/10X$ unterhalb der an der Wand angebrachten Linie befindet.

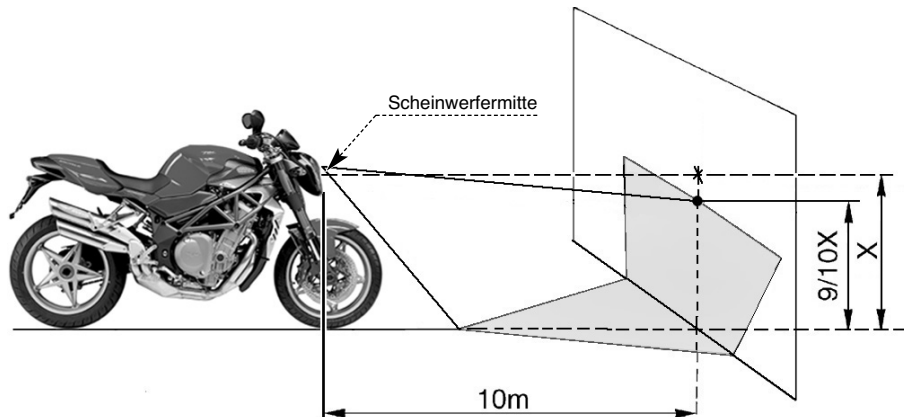



Die Einstellung des vorderen Scheinwerfers kann bei Betätigung der abgebildeten Schraube erfolgen. In Uhrzeigersinn: der Scheinwerfer wird nach unten geneigt. Gegen den Uhrzeigersinn: der Scheinwerfer wird nach oben geneigt. Die Neigung, hinsichtlich der Standardposition, kann von $\pm 4^\circ$ geändert werden.

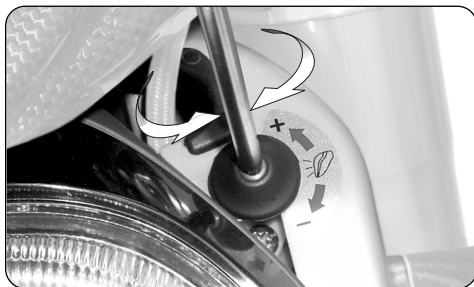
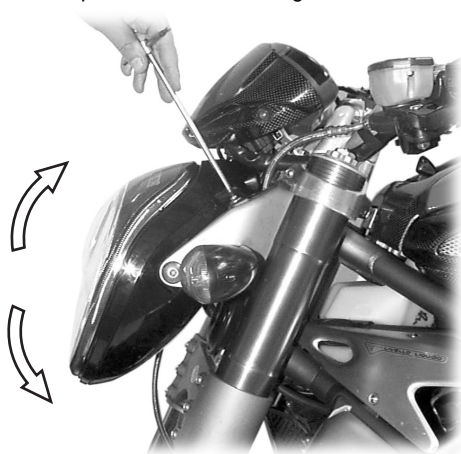



Informationshinweis

MV Agusta S.p.A. verfolgt eine Politik ständiger Verbesserung ihrer Produkte. Aus diesem Grund kann es vorkommen, dass kleine Abweichungen zwischen dem vorliegenden Dokument und dem von Ihnen erworbenen Fahrzeug bestehen. Die Modelle MV Agusta werden in zahlreiche Länder exportiert, in denen unterschiedliche Straßenverkehrsordnungen und Zulassungsverfahren bestehen. In der Hoffnung auf Ihr Verständnis behält sich MV Agusta S.p.A. deshalb das Recht vor, jederzeit und ohne Vorankündigung, Änderungen an ihren Produkten und den technischen Dokumentationen vorzunehmen.

Wir schlagen vor, um den Internetplatz www.mvagusta.it häufig zu besichtigen, um Informationen und Updates über die MV Agusta-Produkte und die in Verbindung stehenden Unterlagen zu erhalten.



Die Umwelt schützen und respektieren

Alles was wir tun hat Auswirkungen auf den gesamten Planeten und seine Ressourcen. Zum Schutz der Gemeinschaft weist MV Agusta die Kunden und die Angestellten im Kundendienst darauf hin, wie das Motorrad umweltschonend genutzt und Motorradbauteile und Flüssigkeiten entsprechend der geltenden Umweltschutzgesetze entsorgt bzw. dem Recycling zugeführt werden können.

© 2006

Die vollständige oder teilweise Vervielfältigung dieses Dokuments ist ohne vorherige schriftliche Genehmigung der MV Agusta S.p.A. verboten.

Teilnr. 8000A9724

Ausgabe Nr. 1 - Oktober 2006

MV AGUSTA

**910
BRUTALE**



Manual de uso
Versión en Español

Estimado cliente,

Le agradecemos la confianza que nos ha otorgado y le felicitamos por su nueva F4 Brutale 910 S. MV Agusta, gracias a la pasión y a la escrupulosidad de sus técnicos se propone nuevamente a sus aficionados con un producto caracterizado por una inédita cualidad estética junto a una refinada parte ciclística: elementos que han contramarcado todas las creaciones de la marca MV Agusta a lo largo de su gloriosa historia.

El resultado es una moto exclusiva que por sus características estéticas y funcionales y las innumerables innovaciones técnicas, se coloca por encima de productos de mas alto perfil que el mercado de la moto pueda ofrecer hoy.

Las soluciones adoptadas otorgan, en efecto, a F4 Brutale 910 S ese inconfundible carácter que la atan a los otros modelos de la familia MV Agusta, reforzando una filosofía de proyecto que privilegia la constante búsqueda, innovación tecnológica y el amor por el detalle, dando la posibilidad a quien vive la propia pasión de motociclista en plena libertad, de poseer un objeto único en el mundo que se coloca con prepotencia como referencia en el ámbito mundial.

Si desea más información, no dude en ponerse en contacto con el Servicio de Asistencia Clientes de MV Agusta.

¡Buena diversión!

*Claudio Castiglioni
Presidente
MV Agusta*



ÍNDICE GENERAL

<i>Cap.</i>	<i>Descripción temas</i>	<i>pág.</i>	<i>Cap.</i>	<i>Descripción temas</i>	<i>pág.</i>
1	INFORMACIÓN GENERAL	5	4	USO	31
1.1.	Finalidad del manual	5	4.1.	Uso de la motocicleta	31
1.2.	Símbolos	6	4.2.	Rodaje	32
1.3.	Contenido del CD-Rom	7	4.3.	Arranque del motor	34
1.4.	Datos de identificación	8	4.4.	Selección y modificación funciones display	36
2	INFORMACIÓN SOBRE LA SEGURIDAD	11	4.4.1.	Selección de las funciones de la pantalla	37
2.1.	Uso consentido del vehículo	11	4.4.2.	Regulaciones de la unidad de medida	38
2.2.	Mantenimiento	11	4.4.3.	Anulación de las funciones	
2.3.	Accesorios y modificaciones	12		cuentakilómetros parciales	41
2.4.	Carga vehículo	12	4.4.4.	Ajuste de la función reloj	44
3	MANDOS Y INSTRUMENTOS	14	4.5.	Abastecimiento combustible	46
3.1.	Posición mandos y instrumentos	14	4.6.	Acceso al hueco portaobjetos	48
3.2.	Caballote lateral	16	4.7.	Inactividad de la motocicleta	50
3.3.	Mandos en el lado izquierdo del manillar	17	5	REGULACIONES	52
3.4.	Mandos en el lado derecho del manillar	19	5.1.	Lista regulaciones	52
3.5.	Interruptor encendido y bloqueo del manillar	22	5.2.	Tabla de las regulaciones	55
3.6.	Mando cambio	26	5.3.	Regulación de la palanca del freno delantero	56
3.7.	Instrumentos y testigos	27	5.4.	Regulación de la palanca de embrague	56
3.7.1.	Testigos	28	5.5.	Regulación de los espejos retrovisores	57
3.7.2.	Pantalla multifunción	29	5.6.	Regulación de la suspensión delantera	58
3.8.	Tabla de lubricantes y líquidos	30	5.6.1.	Precarga muelle	59



ÍNDICE GENERAL

<i>Cap.</i>	<i>Descripción temas</i>	<i>pág.</i>
5.6.2.	Dispositivo hidráulico de frenado en extensión (suspensión delantera)	59
5.6.3.	Dispositivo hidráulico de frenado en compresión (suspensión delantera)	60
5.7.	Regulación de la suspensión trasera	61
5.7.1.	Dispositivo hidráulico de frenado en extensión (suspensión trasera)	62
5.7.2.	Dispositivo hidráulico de frenado en compresión para alta velocidad (suspensión trasera)	63
5.7.3.	Dispositivo hidráulico de frenado en compresión para baja velocidad (suspensión trasera)	63
5.8.	Ajuste proyector delantero	64



1.1. Finalidad del manual

El presente manual proporciona toda la información necesaria para un uso correcto y seguro de la moto.

Junto al manual se entrega también un “Quick Manual” de bolsillo, con una síntesis esencial de la información necesaria para el uso del vehículo.

El manual se entrega también en formato electrónico (.pdf) en este CD-Rom, y puede ser impreso o visualizado en cualquier ordenador, ya sea en sistema Windows que Macintosh.

Le recomendamos leer atentamente el manual antes de utilizar la moto y cerciorarse de cualquier otra persona que la use haya hecho lo mismo.

Por último, le aconsejamos llevar siempre con Usted el “Quick Manual” y de rellenarlo con los datos identificativos suyos y de la motocicleta.



Copyright
MV AGUSTA Motor Spa
Todos los derechos reservados



1.2. Símbolos

Las partes del texto de particular importancia, correspondientes a la seguridad de la persona y a la integridad de la motocicleta, están evidenciadas con los siguientes símbolos:



Peligro - Atención: la falta o el incompleto cumplimiento de estas prescripciones puede comportar un grave peligro para su incolumidad o para la de otras personas.



Prudencia - Precaución: la falta o el incompleto cumplimiento de estas prescripciones puede comportar un riesgo de daños a la motocicleta.

Para indicar las personas autorizadas al desarrollo de las operaciones de ajustes y/o mantenimiento, las mismas se encuentran marcadas con los símbolos siguientes:



Información de las operaciones permitidas al motociclista.



Información de las operaciones que deben ser llevadas a cabo sólo por personal autorizado.

Para poner en evidencia ulteriores informaciones se utilizan los siguientes símbolos:



El símbolo  indica que es necesario utilizar una herramienta o utillaje específico para realizar correctamente la operación descrita.



El símbolo “§” indica que nos remitimos al capítulo indicado por el número que lo sigue.



1.3. Contenido del CD-Rom

En el presente CD-Rom Usted podrá encontrar, además de este manual, el Manual de Mantenimiento, el “Quick Manual” (del que también se entrega una versión impresa), la Guía de las Concesionarias y el Folleto de la Garantía.

Al momento de la entrega de la motocicleta, su Concesionario le habrá entregado también el Certificado de Garantía y Pre-Entrega.

Le rogamos conservarlo junto con los documentos de la moto y los futuros cupones de mantenimiento que recibirá cada vez que realice las intervenciones programadas.

IMPORTANTE

La copia del Certificado de Garantía y Pre-entrega destinada a MV Agusta debe ser rellenada por el Concesionario y devuelta a la fábrica dentro de 10 días a partir de la fecha de matriculación.

Las copias de los cupones de manutención recomendada deben ser rellenadas siempre por los Concesionarios y devueltos a MV Agusta dentro de los 10 días siguientes a la fecha de la realización de las intervenciones.



ES 1



1.4. Datos de identificación

- 1) número de matrícula chasis
- 2) número de matrícula motor
- 3) datos de homologación

► Identificación motocicleta

La motocicleta está identificada por el número de matrícula del chasis. Para pedir piezas de recambio, además de este número, puede ser necesario indicar el número de matrícula del motor, el código del color y el número de identificación de la llave.

Se recomienda anotar los datos principales en los siguientes espacios:

CHASIS N.: _____

MOTOR N.: _____



► Identificación de la llave de la motocicleta

Se suministran dos llaves, una llave se utiliza sea para el arranque para accionar las cerraduras. Guarde en un lugar seguro la llave de reserva.

Tener conocimiento del número de identificación de la llave es indispensable en el caso sea necesario pedir un duplicado de la llave como recambio. Se recomienda anotar el número de identificación de la llave en el espacio siguiente:

LLAVE N.:

► Identificación combinación colores motocicleta

El código del color es indispensable para pedir las piezas de recambio de la carrocería. El mismo puede ser leído en la placa colocada en el lado inferior izquierdo del depósito gasolina.

Para acceder a la placa del código color, es necesario quitar el lateral depósito izquierdo.

Saque la parte posterior del lateral depósito izquierdo según lo demostrado en la figura.

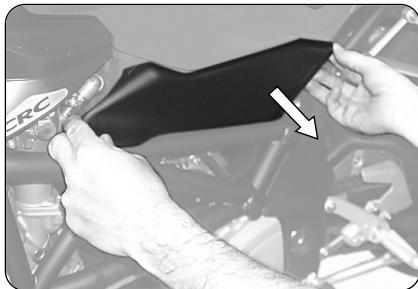

1

ES



ES 1

Quite el lateral deposito izquierdo tirando de él hacia la parte posterior de la motocicleta.

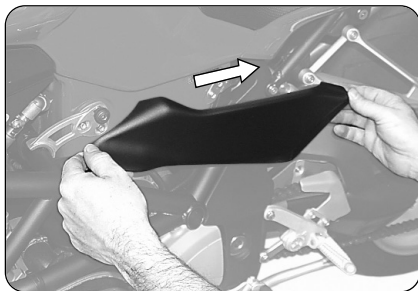

Después de haber quitado el lateral deposito izquierdo, se pueda ver la placa con el código color. En ésta placa es posible conocer el código del color de la motocicleta, el cual determina el color de las partes de la carrocería.

Se aconseja anotar el código color de la motocicleta en el espacio siguiente:

CÓDIGO COLOR :

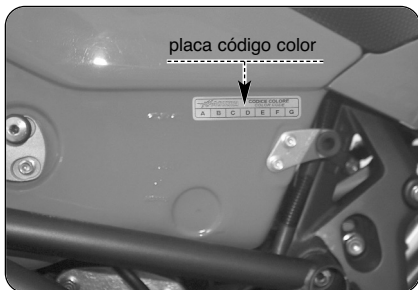



2.1. USO CONSENTIDO DEL VEHÍCULO

Su motocicleta ha sido proyectada para transitar exclusivamente por carreteras y autopistas.



ATENCIÓN

Saltuariamente es posible utilizar la motocicleta en pistas, pero en ocasiones que no prevean la competición.

Sin embargo, a causa del mayor esfuerzo al que se somete la moto en tales ocasiones, en ese caso se recomienda hacer controlar las condiciones del vehículo por un Centro de Asistencia MV Agusta antes y después del uso.

Cualquier otro uso está prohibido y expresamente excluido.

Para más información acerca del uso de la moto, consulte la sección 4 del presente manual.

2.2. MANTENIMIENTO

A fin de garantizar la máxima eficiencia y fiabilidad del vehículo, es esencial efectuar las intervenciones de mantenimiento previstas en el Manual de Mantenimiento.

MV Agusta recomienda que todas las operaciones de mantenimiento sean efectuadas exclusivamente por personal especializado perteneciente a un Centro de Asistencia MV Agusta.

En caso de que Usted decida efectuar las intervenciones de mantenimiento en otros talleres, deberá constatar que los mismos cuenten con la capacidad y los instrumentos específicos necesarios para la ejecución de tales operaciones.



ATENCIÓN

La garantía MV Agusta puede perder validez en caso de que otros talleres hayan efectuado intervenciones no conformes con las previstas en las Circulares Técnicas y los Manuales de Taller MV Agusta.



2.3. ACCESORIOS Y MODIFICACIONES



ATENCIÓN

MV Agusta prohíbe aportar cualquier tipo de modificación a sus motocicletas. Ello es necesario para tutelar la seguridad de sus Clientes.

De todos modos, Usted puede personalizar su motocicleta utilizando los artículos del vasto Catálogo de Accesorios MV Agusta.



ATENCIÓN

La instalación de algunos de estos accesorios puede invalidar la homologación de la moto y, por ende, comprometer su posibilidad de tránsito por las vías públicas.

En caso de dudas, le aconsejamos recurrir a su Concesionario MV Agusta de confianza para decidir cuáles son los accesorios más adecuados a sus propias exigencias.

2.4. CARGA DEL VEHICULO

El vehículo ha sido proyectado para ser usado por parte del piloto y de un eventual pasajero. Para utilizarlo en plena seguridad y respetando las normas del código de la circulación es obligatorio no superar nunca el peso bruto total máximo permitido del vehículo, el cual valor es indicado a continuación:

BRUTALE 910 S

Peso total máximo	370 kg
Peso de la carga máxima	180 kg

El peso total máximo representa la adición de los siguientes pesos, según la directiva CEE 92/61:

- peso de la motocicleta;
- peso del piloto;
- peso del pasajero;
- peso de la carga y de los accesorios.

**ATENCIÓN**

Considerado que la carga tiene una enorme importancia en la manejabilidad, la frenada, el rendimiento y las características de seguridad de vuestro vehículo, tener presente siempre las siguientes precauciones.

- **NO SOBRECARGAR NUNCA EL VEHICULO!** La utilización de una moto sobre cargada puede provocar daños a los neumáticos, pérdida del control o graves accidentes. Comprobar que el peso total del piloto, del pasajero, de la carga y de los accesorios no supere el peso máximo especificado para la moto.



3.1. Posición mandos e instrumentos

ES 3

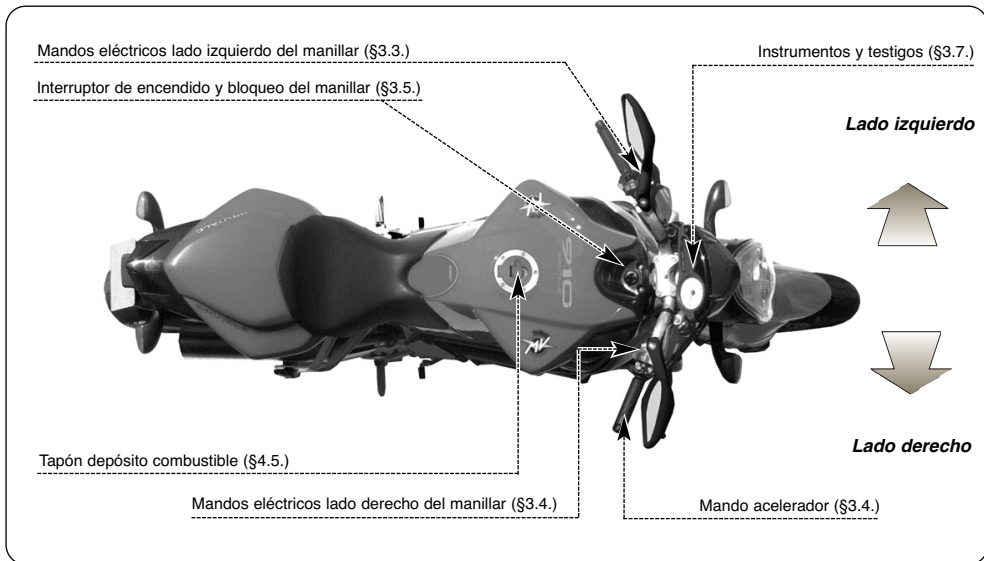

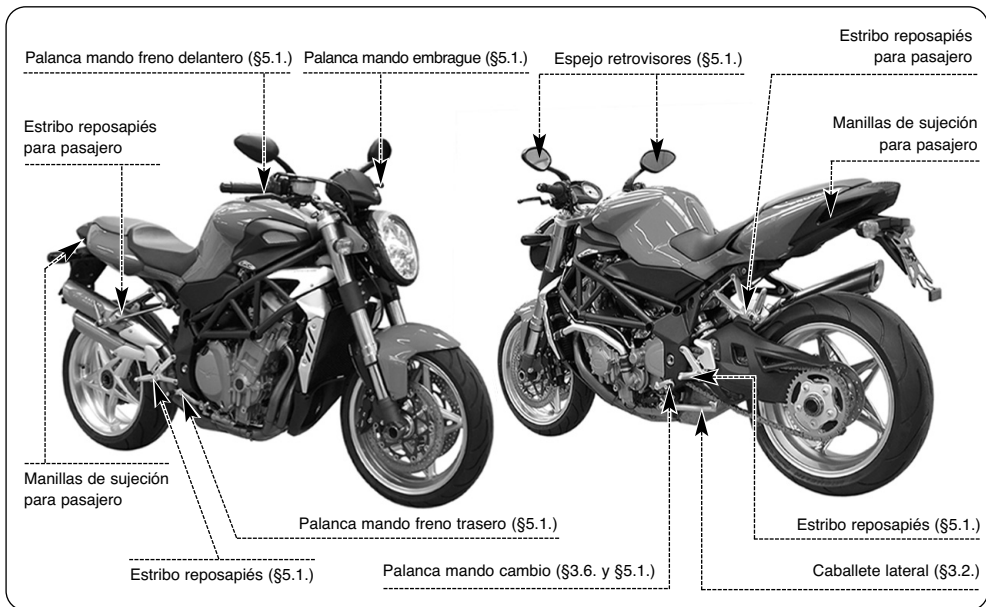



3.2. Caballete lateral

El caballete lateral está equipado con un interruptor de seguridad que impide a la moto de ponerse en marcha con el caballete bajado.

En el caso que con el motor en marcha y con el caballete bajado, se acciona el cambio para salir, el interruptor corta la corriente al motor provocando la parada.

En el caso que la moto se encuentre estacionada (con el caballete abajo) y con una velocidad engranada, el interruptor impide el arranque del motor evitando el peligro de caída accidental del vehículo.

ES 3

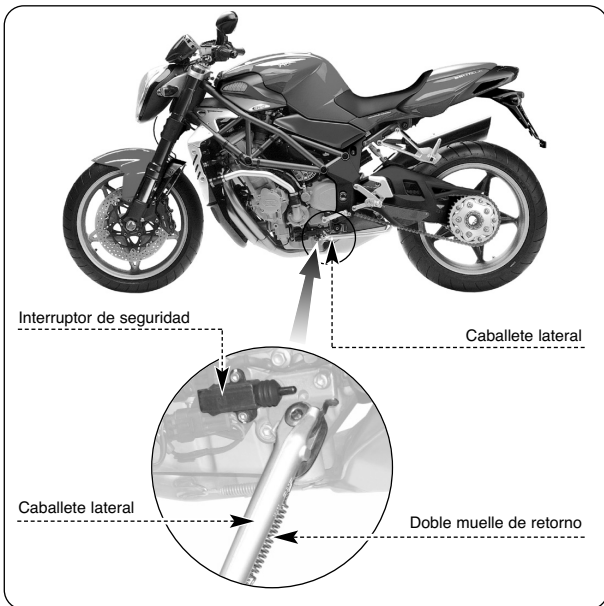



3.3. Mandos lado izquierdo del manillar

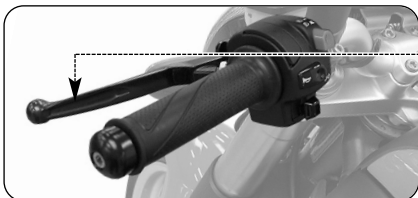

Palanca embrague



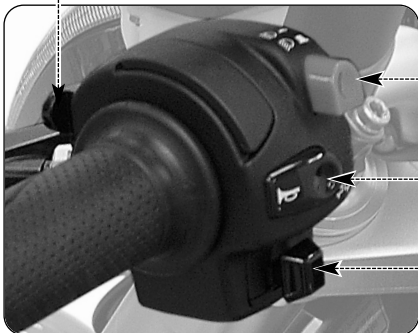

Acercar o alejar de la manecilla para accionar el embrague.



Pulsador centelleo faros

Apriete el pulsador repetidas veces.

Pulsador carretera/cruce

Pulsador hacia fuera  : cruce 
Pulsador hacia dentro  : carretera 

Pulsador claxon

Apriete para activar el claxon.

Palanca indicadores de dirección

Desplazando la palanca hacia la derecha o hacia la izquierda se activan los indicadores de dirección derechos o izquierdos. La palanca regresa al centro; apriete para desactivar los indicadores.



Pulsador Destello Faro

Esta función sirve para llamar la atención de los demás en el caso de posible situaciones de peligro; con la luz de carretera encendida dicha función no se activa.

Pulsador De carretera/De cruce

Normalmente es activada la función luz de cruce; cuando las condiciones del tráfico y de recorrido lo permiten, puede ser activada la función luz de carretera actuando en el pulsador.

Leva Indicadores de Dirección

Esta función permite señalar a los demás la intención de cambiar dirección o carril de marcha.



PELIGRO

No usar o no desactivar los indicadores de dirección en el momento oportuno puede provocar accidentes; los demás conductores podrían interpretar erróneamente el trayecto del vehículo. Accionar siempre los indicadores de dirección antes de girar o cambiar carril. Asegurarse después de desactivar los indicadores apenas efectuada dicha maniobra.

Pulsador del Claxon

Esta función sirve para llamar la atención de los demás conductores en el caso de posible condición de peligro.

Palanca Embrague

Esta palanca, a través de un dispositivo controlado hidráulicamente, permite accionar el embrague.



3.4. Mandos lado derecho del manillar

Palanca freno delantero

Acercarse a la manecilla para accionar el freno delantero.

Mando acelerador

Girar para regular la alimentación del motor.

Palanca arranque en frío del motor (Choke)

Gire en sentido horario para el arranque en frío del motor.
Pasados algunos segundos lleve la palanca a su posición inicial.

Interruptor stop motor

Si se acciona detiene el motor e impide su arranque.

Pulsador arranque motor

Apretado arranca el motor. Se debe soltar apenas arranca el motor. Con motor arrancado, apretándolo de nuevo, se seleccionan las funciones de la pantalla.

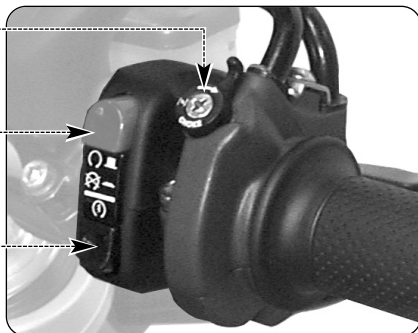
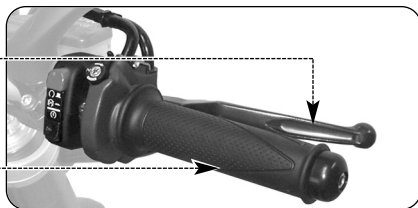



Interruptor Parada Motor

Esta función permite parar el motor en caso de emergencia; de ésta manera se desactiva el circuito de encendido impidiendo el arranque del motor. Para poder efectuar el arranque colocar nuevamente el pulsador en posición de descanso.

NOTA

En condiciones normales no utilizar éste dispositivo para parar el motor.

Pulsador Puesta en marcha del Motor

Este dispositivo permite la puesta en marcha del motor; además con el motor en marcha permite seleccionar las funciones del display presente en la instrumentación de a bordo.



PRUDENCIA - PRECAUCION

Para evitar daños a la instalación eléctrica no tener presionado el pulsador por mas de 5 segundos consecutivos.

Si el motor no arranca después de varios tentativos, consultar el capítulo “AVERÌAS” en éste manual.

Leva Puesta en marcha en frío del Motor (Choke)

El dispositivo facilita el arranque en frío actuando en la alimentación.

NOTA

Esta función debe estar activa por un tiempo limitado y de cualquier manera dependiendo de la temperatura del motor y del ambiente externo. Cuando el régimen de ralentí es suficiente para mantener prendido el motor, es oportuno desactivar el mando.



Mando Acelerador

Este dispositivo permite regular la alimentación del motor variando el régimen de rotación. Para accionar el dispositivo es necesario girar la manecilla en la posición de descanso, que corresponde al régimen de ralenti del motor.

Arrancando en frío (Choke activo), la rotación repetida de la manecilla hacia el cierre del gas permite retornar la leva del choke en posición de descanso.

Palanca Freno Delantero

Este mando permite accionar a través de un circuito hidráulico la instalación de frenos de la rueda delantera.



3.5. Interruptor de encendido y bloqueo del manillar



PELIGRO: No colocar llaveros u otros objetos en la llave de encendido para no crear obstáculos en la rotación de la dirección.



PELIGRO: No intentar cambiar la posición del interruptor durante la marcha; se podría perder el control del vehículo.

ES 3

Interruptor de encendido y bloqueo del manillar

Posición "ON"

Posición "OFF"

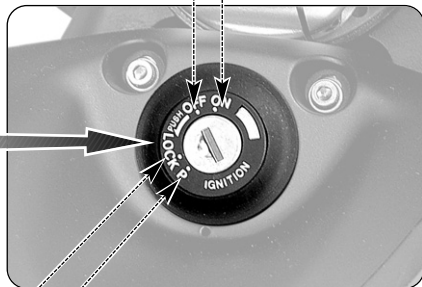
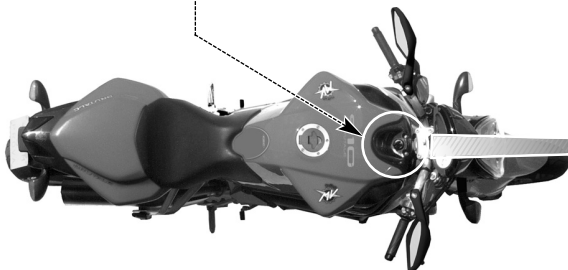

Posición "LOCK"

Posición "P"



El interruptor de encendido activa y desactiva el circuito eléctrico y el bloqueo del manillar; las cuatro posiciones de mando se describen a continuación.

Posición “OFF”

Todos los circuitos eléctricos están desactivados. Se puede extraer la llave.



Posición “ON”

Todos los circuitos eléctricos están activados, los instrumentos y los testigos efectúan el autodiagnóstico; se puede arrancar el motor. La llave no se puede extraer.



PRUDENCIA - PRECAUCION: No dejar la llave en la posición de “ON” por mucho tiempo con el motor apagado, para no dañar los componentes eléctricos de la motocicleta.



Posición "LOCK"

Gire el manillar a la derecha o a la izquierda. Empujar levemente la llave y al mismo tiempo girarla en posición "LOCK".

Todos los circuitos eléctricos están desactivados y el manillar está bloqueado. Se puede extraer la llave.

ES 3

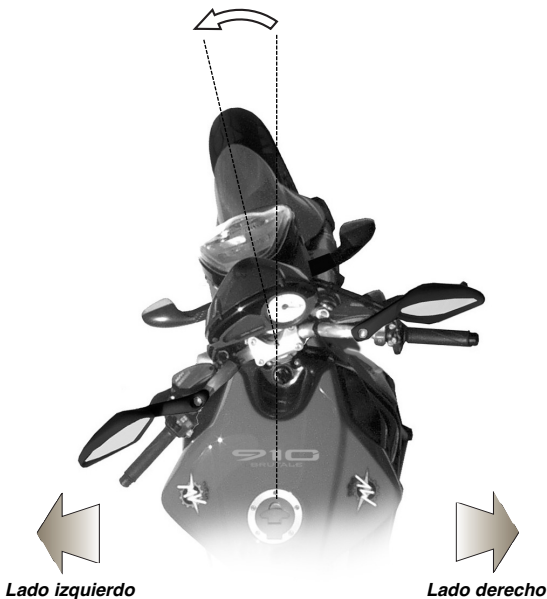

Lado izquierdo

Lado derecho



Posición “P”

Gire la llave de la posición “LOCK” a la posición “P”.

Todos los circuitos eléctricos están desactivados excepto las luces de estacionamiento (luces de posición) y el manillar está bloqueado. Se puede extraer la llave.



PRUDENCIA - PRECAUCION

No dejar la llave en posición “P” por mucho tiempo, para evitar descargar la batería de la motocicleta.



3.6. Mando cambio

La posición **N** "Neutral" corresponde a la posición de punto muerto señalada por el correspondiente testigo en el cuadro mandos.

Desplazando la palanca del cambio hacia abajo se engrana la primera velocidad.

De igual manera, desplazando la palanca hacia arriba se engrana la segunda; continuando varias veces a desplazar la palanca hacia arriba se engranan, en secuencia, todas las demás velocidades hasta la sexta.

ES
3



Palanca mando cambio

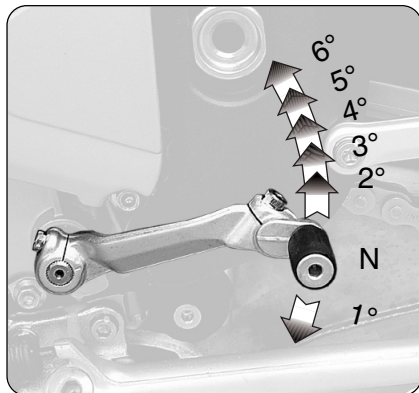



3.7. Instrumentos y testigos

Los instrumentos y los testigos se activan girando la llave de encendido en posición "ON". Después de un check-up inicial (~7 segundos) la información que aparece corresponde a las condiciones generales de la motocicleta en ese momento.

Testigos (§3.7.1.)

Pulsador "SET" (§3.7.2.)

Pantalla multifunción (§3.7.2.)

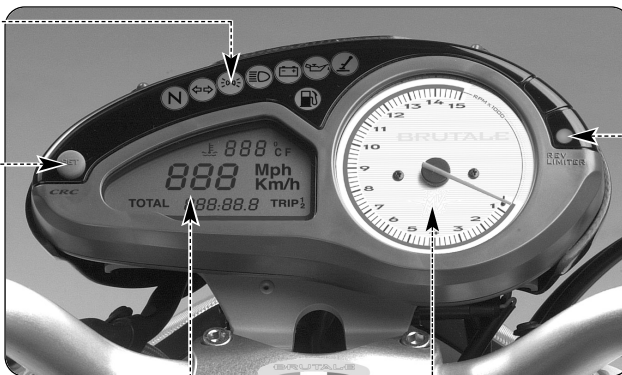

Testigo (§3.7.1.)

Contador de
revoluciones



3.7.1. Testigos

Testigo luz carretera (azul)

Se enciende cuando está activada la luz de carretera.

Testigo carga batería (rojo)

Se enciende cuando el alternador no proporciona la corriente eléctrica suficiente para cargar la batería.

Si el encendido se produce durante la circulación diríjase a un centro de asistencia autorizado.

Testigo luz de cruce (verde)

Se enciende cuando está activada la luz de cruce.

Testigos cambio en punto muerto (verde)

Se enciende cuando el cambio está en la posición punto muerto "Neutral".

Testigo indicadores de dirección (verde)

Se enciende cuando están activados los indicadores de dirección.

Testigo reserva combustible (naranja)

Se enciende cuando en el depósito hay aproximadamente cuatro litros de combustible.

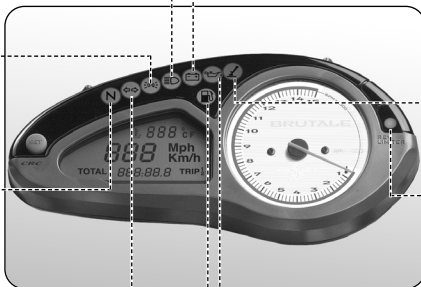

Testigo apertura caballete lateral (rojo)

Se enciende cuando el caballete está bajado.

Testigo limitador de revoluciones (rojo)

Se enciende cuando el motor supera las 11300 rpm; el limitador interviene a 12000 rpm.

Testigo presión aceite motor (rojo)

Se enciende cuando el aceite está a una presión insuficiente.



Peligro-Atención: Si se enciende durante la circulación, deténgase inmediatamente, controle el nivel del aceite y si es necesario hace efectuar el relleno por un centro de asistencia autorizado MV Agusta (ver §3.8.). Si el testigo se enciende a pesar de que el nivel es correcto, no siga circulando y póngase en contacto con un centro de asistencia autorizado MV Agusta.



3.7.2. Pantalla multifunción

Velocímetro

Indica la velocidad. El valor puede aparecer en kilómetros por hora (km/h) o bien en millas por hora (Mph). El valor máximo es de 299 Km/h (186 Mph).

Pulsador "SET"

Si se aprieta, permite seleccionar las cifras de la pantalla para efectuar las regulaciones. Si se aprieta nuevamente permite confirmar las cifras introducidas.

Cuentakilómetros total "TOTAL"

Indica el recorrido total, de 0 a 99999.9 (km o mi)

Cuentakilómetros parcial 1 "TRIP 1"

Indica el recorrido parcial, de 0 a 9999.9 (km o mi)

Cuentakilómetros parcial 2 "TRIP 2"

Indica el recorrido parcial, de 0 a 9999.9 (km o mi)

Reloj

Indica la hora (0÷24).

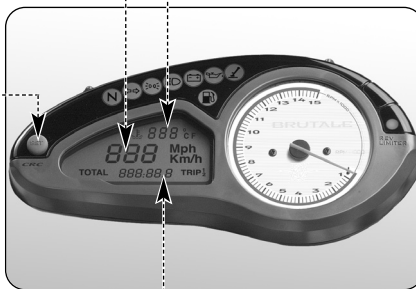

Termómetro

Indica la temperatura del líquido de refrigeración. El valor puede aparecer en grados centígrados (°C) o bien en grados fahrenheit (°F).

El campo de indicación está comprendido entre 40° y 140° C (104° y 284°F):

- por debajo de 40°C (104°F) la indicación no aparece pero aparecen tres líneas que centellean; es la señal de temperatura muy baja;
- entre 40° y 49°C (104° y 120°F) la indicación centellea, es la señal de temperatura baja;
- entre 50° y 111°C (122° y 232°F) la indicación es fija;
- entre 112° y 140°C (234° y 284°F) la indicación centellea; es la señal de tempera alta.



Peligro - Atención: si la temperatura supera los 120°C (248°F) detenga la motocicleta, controle el nivel del líquido de refrigeración. En el caso fuera necesario llenar, póngase en contacto con un centro de asistencia autorizado MV Agusta (ver § 3.8.). Si el testigo se enciende a pesar de que el nivel es el correcto, no siga circulando y póngase en contacto con un centro de asistencia autorizado MV Agusta.

**3.8. Tabla lubricantes y líquidos**

<i>Descripción</i>	<i>Características</i>	<i>Producto aconsejado</i>
Aceite lubricación motor	AGIP RACING 4T 10W/60 (*)	SAE 10W/60 - API SJ
Líquido de refrigeración	AGIP ECO - PERMANENT	Glicol - Etilénico diluido con 50% de agua destilada
Fluido mando embrague y frenos	AGIP BRAKE FLUID DOT4	DOT4
Aceite lubricación cadena	MOTUL CHAIN LUBE ROAD	-

* : Para encontrar fácilmente los productos recomendados, MV Agusta aconseja dirigirse directamente a los propios concesionarios autorizados. El aceite para motor AGIP Racing 4T 10W/60 ha sido realizado especialmente para el motor de la motocicleta F4. En el caso que el lubricante descrito no se consiga, MV Agusta aconseja utilizar aceites completamente sintéticos con características conformes o superiores a las siguientes normas:

- Conforme API SJ
- Conforme ACEA A3
- Conforme JASO MA
- Gradación SAE 20 W-50 o 10 W-60

NOTA

Las especificaciones indicadas deben estar presentes, por sí solas o junto a otras, en el envase del aceite lubricante.





4.1. Uso de la motocicleta

En esta sección se exponen los principales temas para el correcto uso de la motocicleta.



ATENCIÓN

La motocicleta F4 BRUTALE 910 S tiene altas características de potencia y prestaciones; por lo tanto, para su utilización es necesario un adecuado nivel de conocimiento del vehículo. Cuando usted utiliza la motocicleta para la primera vez, es necesario adoptar una actitud prudente. Una agresiva o temeraria actitud de conducción podría aumentar el peligro de accidentes y comportar un grave peligro para su incolumidad o para la de otras personas.



ATENCIÓN

LAS RESTRICCIONES DE USO DEL VEHÍCULO ESTÁN INDICADAS EN LA SECCIÓN "INFORMACIÓN PARA LA SEGURIDAD".



4.2. Rodaje



Prudencia - Precaución: el incumplimiento de las indicaciones a continuación indicadas puede perjudicar la duración y las prestaciones de la motocicleta.

Es muy común considerar el rodaje como una fase aplicada sólo al motor. En realidad el rodaje es importante también para otras partes primordiales de la moto como son los neumáticos, los frenos, la cadena de transmisión, etc. Durante los primeros kilómetros adopte una conducción tranquila.

□ De 0 a 500 km (de 0 a 300 mi) (A)

Durante este recorrido varíe frecuentemente el régimen de rotación del motor, Si es posible, efectúe trayectos con colinas, con muchas curvas y evite largos trechos rectilíneos.

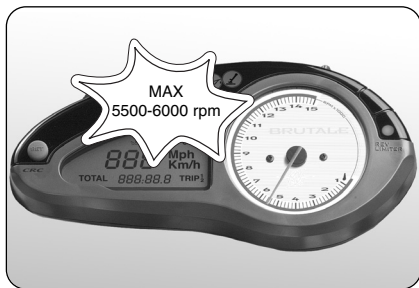

PELIGRO

Los neumáticos nuevos deben ser sometidos a un adecuado rodaje para alcanzar la completa eficiencia. Evitar acelerar, curvas y frenadas bruscas en los primeros 100 km. Si no se realiza un primer periodo de rodaje de los neumáticos, hay riesgo de resbalar o perder el control del vehículo con consiguiente peligro de accidentes.



❑ **De 500 a 1000 km (de 300 a 600 mi)**

Durante este recorrido evite mantener mucho tiempo el motor bajo esfuerzo.

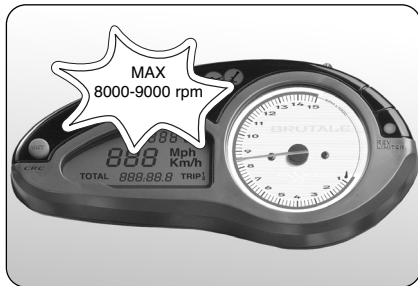

❑ **De 1000 a 2500 km (de 600 a 1600 mi)**

Durante este recorrido es posible pretender mayores prestaciones al motor pero sin superar el régimen de rotación indicado.

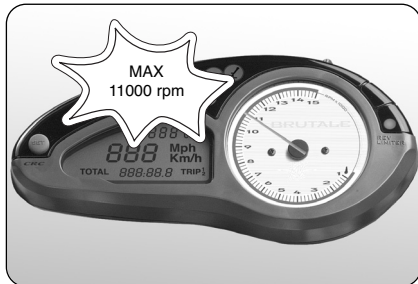



4.3. Arranque motor



PELIGRO

Dejar el motor prendido en un ambiente cerrado puede ser peligroso. Los gases de escape contienen monóxido carbónico, un tipo de gas sin color y sin olor que puede provocar la muerte o graves infortunios. Dejar funcionar el motor solo externamente.

► Girando el interruptor de encendido en posición "ON"; la instrumentación y las luces testigo efectúan el auto-diagnóstico; durante ésta fase, asegurarse que todas las luces testigo en el tablero se enciendan. Para que el sistema de interrupción del circuito de encendido del consentimiento al arranque, se debe haber dado una de las siguientes condiciones:

- El cambio en posición de neutro.
- El cambio se encuentra engranado en una marcha con la palanca del embrague accionada y el caballete lateral levantado.

❑ Arranque en frío

► Gire la palanca "CHOKE", sin girar la maneta del acelerador y presione el pulsador.





▶ Enseguida que el motor se pone en marcha, soltar el pulsador y después de un breve calentamiento retornar la leva en la posición inicial.

❑ **Arranque en caliente**

- ▶ Apriete el pulsador sin girar la maneta del acelerador.
- ▶ Apenas el motor arranca, suelte el pulsador.



Prudencia - Precaución:

- Para evitar daños a la instalación eléctrica no se debe accionar el arranque por mas de 5 segundos consecutivos.
- No dejar el motor en marcha por mucho tiempo con la moto parada. El consiguiente recalentamiento puede dañar los componentes internos del motor. Es preferible llevar el motor a la temperatura de ejercicio saliendo a una a baja velocidad.
- Para prolongar al máximo la durabilidad del motor, no acelerar a fondo cuando el motor está frío.





4.4. Selección y modificación de las funciones display

La instrumentación prevé la posibilidad de intervención en algunos de los parámetros principales de medición e iniciar la función cronómetro.

Las operaciones posibles son:

- Selección de las funciones:

Cuentakilómetros	Total	"TOTAL"
Cuentakilómetros	Parcial 1	"TRIP 1"
Cuentakilómetros	Parcial 2	"TRIP 2"
Reloj		

- Ajuste de la unidad de medida relativa a:

Velocidad
Distancia recorrida
Temperatura

- Anulación de las funciones cuentakilómetros parciales:

Cuentakilómetros	Parcial 1	"TRIP 1"
Cuentakilómetros	Parcial 2	"TRIP 2"

- Ajuste de la función reloj.





4.4.1. Selección de las funciones de la pantalla

La selección corresponde a las funciones:

- Cuentalómetros total "TOTAL"
- Cuentalómetros parcial 1 "TRIP 1"
- Cuentalómetros parcial 2 "TRIP 2"
- Reloj

► La representación visual de las funciones "TOTAL", "TRIP 1" y "TRIP 2", se realiza presionando el pulsador de arranque del motor. Actuando en éste pulsador aparecen en el display las funciones en modo cíclico. Seleccionar las funciones deseadas.

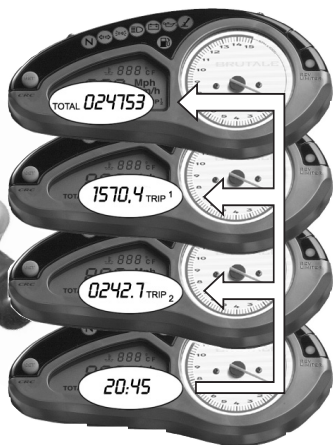

4 ES



PELIGRO

Las operaciones de modificación o ajuste de las funciones del display se deben realizar con motor encendido, cambio en neutro, motocicleta parada y los pies en el suelo. Está prohibido ajustar el display durante la marcha.



4.4.2. Ajuste de la unidad de medida

Es posible efectuar la modificación de la unidad de medida.



PELIGRO

Las operaciones de modificación o ajuste de las funciones del display se deben realizar con motor encendido, cambio en neutro, motocicleta parada y los pies en el suelo. Está prohibido ajustar el display durante la marcha.



❑ Velocímetro (km/h - Mph)

▶ Apretar varias veces el pulsador de puesta en marcha del motor hasta que aparezca la función del cuentakilómetros total "TOTAL".

▶ Apriete el pulsador "SET", la unidad de medida del velocímetro empieza a centellear.





► Apretar el pulsador de puesta en marcha del motor para pasar de km/h a Mph o viceversa. Variando la unidad de medida del velocímetro, también varía automáticamente la del cuentakilómetros (total o parcial).

Recordamos que 1 mi = 1,609 Km.

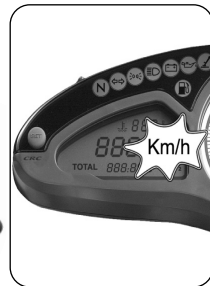

4 ES

► Apriete el pulsador “SET”; la unidad de medida del velocímetro queda confirmada y la unidad de medida del termómetro empieza a centellejar. Se puede efectuar la siguiente regulación.





□ Termómetro (°C - °F)

► Apretar el pulsador de puesta en marcha del motor para pasar de °C a °F o viceversa.

Recordamos que $T (^{\circ}\text{F}) = 1,8 \cdot t (^{\circ}\text{C}) + 32$



► Apriete el pulsador “SET” para confirmar la unidad de medida.





4.4.3. Anulación de las funciones cuentakilómetros parciales

Los valores de las funciones “TRIP1” y “TRIP2” se pueden ajustar a cero de la siguiente manera.



PELIGRO

Las operaciones de modificación o ajuste de las funciones del display se deben realizar con motor encendido, cambio en neutro, motocicleta parada y los pies en el suelo. Está prohibido ajustar el display durante la marcha.

► Presionando el pulsador de arranque del motor activa la función “TRIP 1”.

► Presionar el pulsador de arranque del motor por más de cuatro segundos; el valor “TRIP 1” comienza a destellar.





► Presionando ahora el pulsador de arranque del motor por manos de cuatro segundos el valor va a cero. Si en cambio se presiona el pulsador de arranque del motor por mas de cuatro segundos el proceso de reseteo se interrumpe.



► Presionando el pulsador de arranque del motor activar la función "TRIP 2".





► Presionar el pulsador de arranque del motor por mas de cuatro segundos; el valor “TRIP 2” comienza a destellar.



► Presionando ahora el pulsador de arranque del motor por manos de cuatro segundos el valor va a cero. Si en cambio se presiona el pulsador de arranque del motor por mas de cuatro segundos el proceso de reseteo se interrumpe.



4 ES



4.4.4. Ajuste de la función reloj

Es posible efectuar el ajuste de la función reloj.



PELIGRO

Las operaciones de modificación o ajuste de las funciones del display se deben realizar con motor encendido, cambio en neutro, motocicleta parada y los pies en el suelo. Está prohibido ajustar el display durante la marcha.



► Presionar varias veces el pulsador de arranque del motor hasta que aparece la función del reloj.

► Apriete el pulsador "SET"; la primera cifra de la hora empieza a centellear.





► Presionar el pulsador de arranque del motor para ajustar la cifra; dejar apenas aparezca la cifra deseada.

NOTA

Para que las cifras pasen rápidamente tener presionado el pulsador de arranque del motor por mas de dos segundos.

► Apretar el pulsador “SET” para confirmar y para proceder con el ajuste de la cifra sucesiva.

► Repetir el procedimiento para el ajuste de la segunda cifra de la hora, la primera y la segunda cifra de los minutos.

► Apretar el pulsador “SET” para confirmar el ajuste de la hora y para interrumpir la selección (el destello).

NOTA

La instrumentación dispone de una memoria integral que conserva todos los parámetros también con el motor apagado. Con excepción del reloj, el cual se anula, todos los demás parámetros quedan en la memoria aún desconectando la batería.

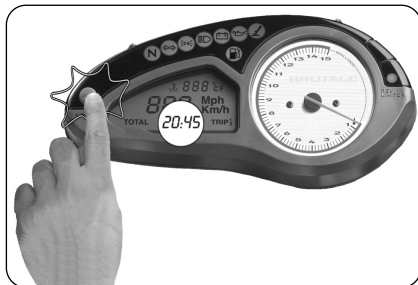



4.5. Abastecimiento combustible



Peligro – Atención: la gasolina y sus vapores son extremadamente inflamables y dañosos. Evitar el contacto y la inhalación.

Durante el abastecimiento apagar el motor, no fumar, tener lejos llamas, chispas y fuentes de calor. Efectuar el llenado en un lugar abierto o en un sitio bien ventilado.



Prudencia – Precaución: utilizar exclusivamente gasolina super sin plomo con 95 octanos (R.O.N.) o mas. Esta necesidad es recordada por un punto verde en la parte inferior de la tapa del deposito.

- ▶ Levante la tapa parapolvo.
- ▶ Introduzca la llave, gírela en sentido horario.

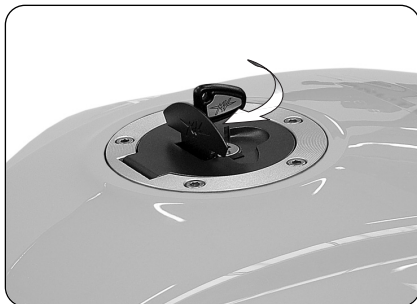
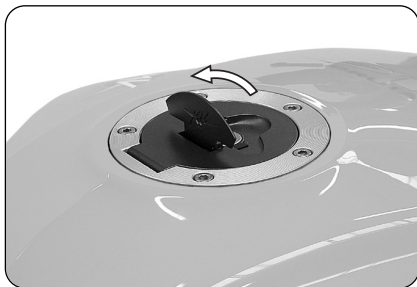





► Levantar la tapa y efectuar el abastecimiento de carburante.

 **PELIGRO:** Llenando excesivamente el depósito puede provocar derrame del carburante debido a la expansión del calor provocada por el calor del motor o a la exposición de la motocicleta a la luz del sol. Eventual derrame de carburante puede provocar incendios. El nivel del carburante en el depósito no debe superar nunca la base de la boca de llenado.

► Después del abastecimiento presione el tapón hacia abajo girando contemporáneamente la llave en sentido horario para facilitar el cierre. Suelte la llave y extráigala.

 **Prudencia - Precaución:** secar enseguida con un trapo limpio eventual carburante derramado, puesto que podría dañar la superficie pintada o de plástico.

 **PELIGRO:** Verificar que la tapa del depósito del carburante esté cerrada correctamente antes de utilizar el vehículo.

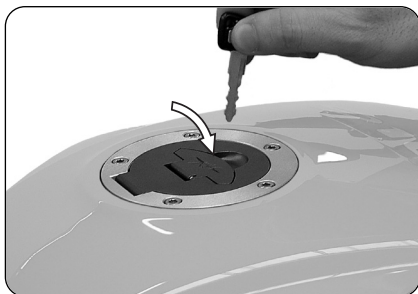
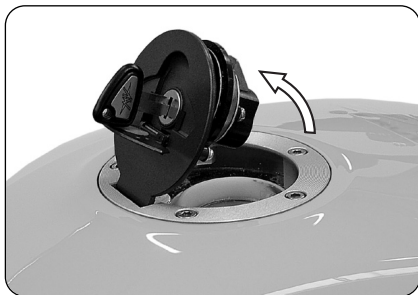



4.6. Acceso al hueco portaobjetos

► Introducir la llave en la cerradura.

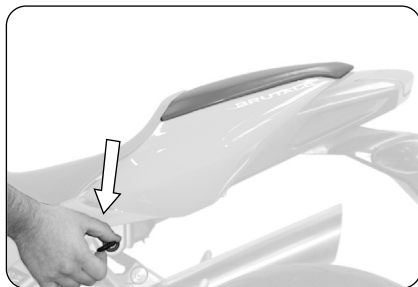

► Girar la llave hacia la derecha y al mismo tiempo presionar levemente sobre el sillín del pasajero. Levantar el sillín.





► Extraer el sillín del pasajero.

Para montar nuevamente la pieza, seguir las siguientes indicaciones:

- Girar la llave en la cerradura.
- Presionar el sillín del pasajero.
- Soltar la llave.
- Presionar nuevamente sobre el sillín cerciorándose que el mismo se encuentre muy bien enganchado a la estructura.



ATENCIÓN

Después de haber quitado y levantado el sillín del pasajero, y de todas maneras antes de utilizar la motocicleta, cerciorarse que el mismo haya sido colocado correctamente y que se encuentre bien sujeto a la estructura principal del vehículo.



4.7. Estacionamiento de la motocicleta

❑ Estacionamiento con caballete lateral



PRUDENCIA - PRECAUCION

Aparcar la motocicleta en condiciones de seguridad y en un terreno estable. En las pendientes estacionar la moto con la rueda delantera hacia la subida y con la primera velocidad engranada; recordarse de retornar el cambio en neutro antes de poner en marcha el vehículo.

No dejar el vehículo sin custodia con la llave de encendido introducida en el cuadro.

- ▶ Bajar el caballete con el pie hasta el tope e inclinar lentamente la motocicleta para colocar el pie de apoyo a contacto con el suelo.

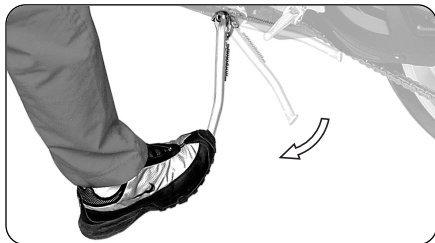

Cuando el vehículo esté parado sobre el caballete lateral, es peligroso sentarse sobre él cargando todo el peso sobre el único apoyo de estacionamiento. Antes de ponerse en marcha verificar el buen funcionamiento del interruptor de seguridad cerciorandose que la luz testigo del caballete lateral ubicada en el tablero se apague; de todas maneras verificar que el caballete lateral haya retornado. Si se nota una imperfección, hacer controlar la instalación por un concesionario MV Agusta antes de utilizar el vehículo.



□ Estacionamiento con caballete trasero

Introducir el perno del caballete en el orificio del eje de la rueda trasera en el lado izquierdo de la moto; apoyar el caballete en el suelo y empujándolo, levantar el vehículo hasta que el vehículo esté estable.



PRUDENCIA - PRECAUCION

Esta operación se debe realizar por dos personas.

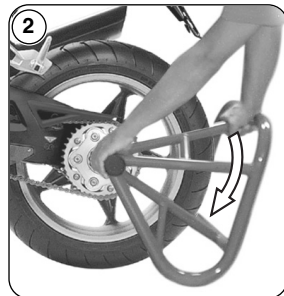
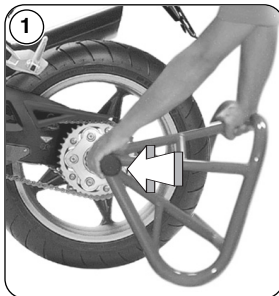



5.1. Lista regulaciones

La motocicleta posee una amplia posibilidad de regulaciones que pueden mejorar la ergonomía, la estabilidad y la seguridad.

Sin embargo algunas de estas regulaciones pueden ser realizadas exclusivamente por los Centros de Asistencia MV Agusta, dado que una regulación errónea de ciertos componentes sumamente importantes puede provocar una situación de peligro.



PELIGRO

Las regulaciones se deben realizar con el vehículo parado.



(F) Regulación espejo retrovisor (§5.5.)

(A) Regulación palanca freno delantero (§5.3.)

(C) Regulación estribo derecho (§5.2)

(H) Regulación suspensión trasera (§5.7.)

(E) Regulación palanca freno trasero (§5.2.)

(G) Regulación suspensión delantera (§5.6)

(M) Orientación faro (§5.8.)

(G) Regulación suspensión delantera (§5.6)





(F) Regulación espejo retrovisor (§5.5.)

(H) Regulación suspensión trasera (§5.7.)

(B) Regulación palanca
embrague (§5.4.)

(D) Regulación palanca
cambio (§5.2.)

(C) Regulación estribo izquierdo (§5.2.)

(L) Regulación
cadena (§5.2.)





5.2. Tabla de las regulaciones

	A - Regulación palanca freno delantero: para optimizar el funcionamiento según las exigencias del motociclista (§5.3).		G - Regulación suspensión delantera: para adaptar su respuesta a las preferencias del motociclista se pueden regular: <ul style="list-style-type: none">- precarga muelle (§5.6.1.)- dispositivo hidráulico de frenado en extensión (§5.6.2.)- dispositivo hidráulico de frenado en compresión (§5.6.3.)
	B - Regulación palanca embrague: para optimizar el funcionamiento según las exigencias del motociclista (§5.4).		H - Regulación suspensión trasera: para adaptar su respuesta a las preferencias del motociclista se pueden regular: <ul style="list-style-type: none">- precarga muelle- altura rectificado
	C - Regulaciones estribos reposapiés (derecho y izquierdo): para optimizar la posición de los pies en función de las exigencias del motociclista.		<ul style="list-style-type: none">- dispositivo hidráulico de frenado en extensión (§5.7.1.)
	D - Regulación palanca cambio: para optimizar el movimiento del mando en función de las exigencias del motociclista.		<ul style="list-style-type: none">- dispositivo hidráulico de frenado en compresión para alta velocidad (§5.7.2.)- dispositivo hidráulico de frenado en compresión para baja velocidad (§5.7.3.)
	E - Regulación palanca freno trasero: para optimizar el movimiento de los mandos en función de las exigencias del motociclista.		L - Regulación cadena: para la eficacia y la seguridad de la transmisión.
	F - Regulación espejos retrovisores: para optimizar la orientación (§5.5). ATENCIÓN: No intervenir en el tornillo de fijación del espejo retrovisor al manillar. En caso de necesidad, dirigirse a un concesionario MV Agusta.		M - Orientación faro: para optimizar la profundidad del haz luminoso en función del equilibrado (§5.8).



5.3. Regulación de la palanca del freno delantero

Tire de la palanca para neutralizar el empuje del muelle y, contemporáneamente, ajuste la posición girando la virola en sentido horario o contrario a las agujas del reloj. En sentido horario: la palanca se aleja de la maneta. En sentido contrario a las agujas del reloj: la palanca se acerca a la maneta.

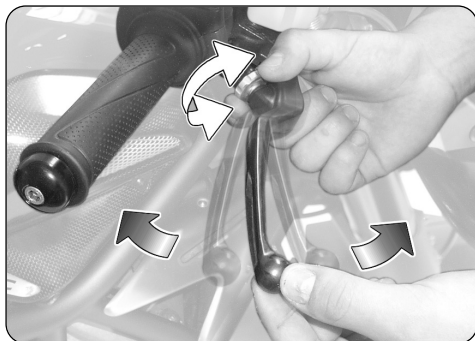

5.4. Regulación de la palanca del embrague

Tire de la palanca para neutralizar el empuje del muelle y, contemporáneamente, ajuste la posición girando la virola en sentido horario o contrario a las agujas del reloj. En sentido horario: la palanca se aleja de la maneta. En sentido contrario a las agujas del reloj: la palanca se acerca a la maneta.





5.5. Regulación de los espejos retrovisores

Apriete los puntos puestos en evidencia para regular la posición en las cuatro direcciones.

Efectuar el ajuste en ambos espejos retrovisores. Para realizar un óptimo ajuste, aconsejamos realizarlo subidos en el vehículo.

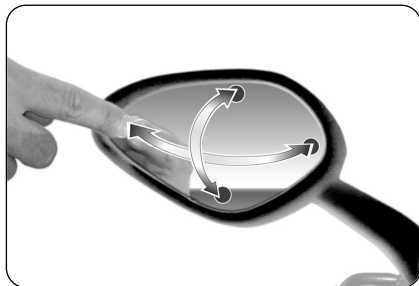



5.6. Regulación de la suspensión delantera



PELIGRO: Es fundamental que las regulaciones de ambas barras de la horquilla se encuentren en la misma posición.

NOTA: La regulación de las suspensiones se debe realizar preferiblemente con el depósito del combustible lleno.

Dispositivo hidráulico de frenado en extensión

Precarga muelle

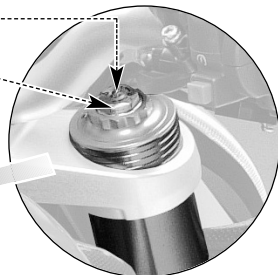

Dispositivo hidráulico de frenado en compresión

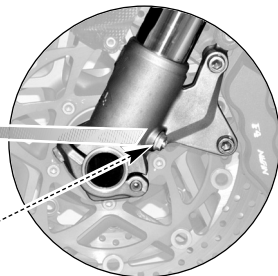



5.6.1. Precarga muelle

La regulación se debe efectuar partiendo de la posición standard. Para encontrar tal posición es necesario girar en sentido contrario a las agujas del reloj hasta el tope, después en sentido horario hasta la posición standard (véase tabla). Gire en sentido horario para aumentar la precarga muelle, o bien gire en sentido contrario a las agujas del reloj para disminuirla.



5.6.2. Dispositivo hidráulico de frenado en extensión (suspensión delantera)

La regulación se debe efectuar partiendo de la posición standard. Para encontrar tal posición es necesario girar en sentido horario hasta el tope, después en sentido contrario a las agujas del reloj hasta la posición standard (véase tabla). Gire en sentido horario para aumentar la acción de frenado, o bien gire en sentido contrario a las agujas del reloj para disminuirla.





5.6.3. Dispositivo hidráulico de frenado en compresión (suspensión delantera)

La regulación se debe efectuar partiendo de la posición standard. Para encontrar tal posición es necesario girar en sentido horario hasta el tope, después en sentido contrario a las agujas del reloj hasta la posición standard (véase tabla). Gire en sentido horario para aumentar la acción de frenado, o bien gire en sentido contrario a las agujas del reloj para disminuirla.

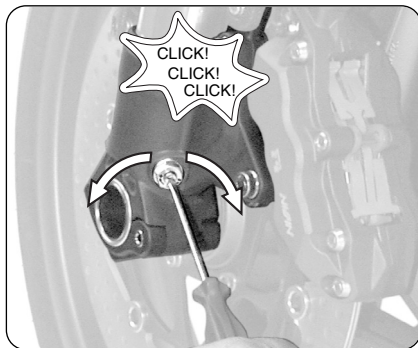



5.7. Regulación de la suspensión trasera



PELIGRO: la alta temperatura del tubo de escape puede provocar quemaduras. Apagar el motor y esperar que los tubos de escape se hayan enfriado antes de efectuar la regulación.

NOTA: La regulación de las suspensiones se debe realizar preferiblemente con el depósito del combustible lleno.



Dispositivo hidráulico de frenado en compresión
(para alta y baja velocidad)

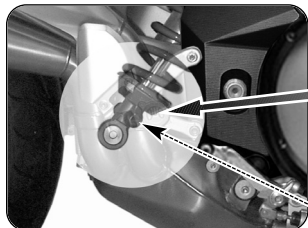

Dispositivo hidráulico de frenado en extensión





5.7.1. Dispositivo hidráulico de frenado en extensión (suspensión trasera)

El ajuste se debe realizar actuando en el tornillo que se encuentra en la parte inferior del amortiguador y partiendo de la posición estándar.

Para encontrar tal posición es necesario girar en sentido horario hasta el tope, después en sentido contrario a las agujas del reloj hasta la posición standard (véase tabla). Gire en sentido horario para aumentar la acción de frenado, o bien gire en sentido contrario a las agujas del reloj para disminuirla.

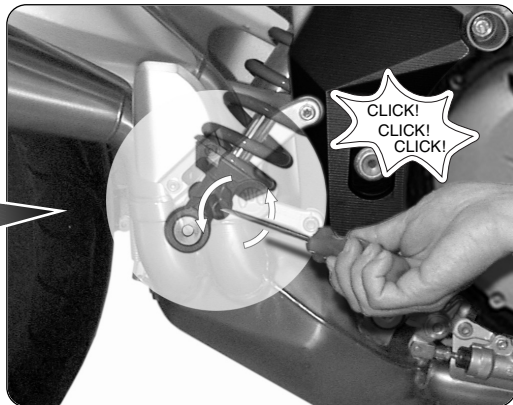
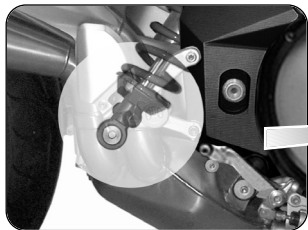



5.7.2. Dispositivo hidráulico de frenado en compresión para alta velocidad (suspensión trasera)

El ajuste se debe realizar actuando sobre la tuerca que se encuentra en la parte superior del amortiguador y partiendo de la posición estándar. Para encontrar tal posición es necesario girar en sentido contrario a las agujas del reloj hasta el tope, después en sentido horario hasta la posición standard (véase tabla). Gire en sentido horario para aumentar la acción de frenado, o bien gire en sentido contrario a las agujas del reloj para disminuirla.



5.7.3. Dispositivo hidráulico de frenado en compresión para baja velocidad (suspensión trasera)

El ajuste se debe realizar actuando sobre el tornillo que se encuentra en la parte superior del amortiguador y partiendo de la posición estándar. Para encontrar tal posición es necesario girar en sentido horario hasta el tope, después en sentido contrario a las agujas del reloj hasta la posición standard (véase tabla). Gire en sentido horario para aumentar la acción de frenado, o bien gire en sentido contrario a las agujas del reloj para disminuirla.





5.8. Ajuste proyector delantero

Colocar el vehículo a 10 metros de distancia de una pared vertical.

Asegurarse que el piso esté plano y que el eje óptico del proyector se encuentre perpendicular a la pared. El vehículo debe estar en posición vertical. Medir la altura del centro del proyector desde el suelo y marcar a esa altura la pared con una cruz.

Prendiendo la luz de cruce, el límite de demarcación entre la zona oscura y la zona iluminada debe resultar a una altura no superior a $9/10$ de la altura desde el suelo del centro del proyector.

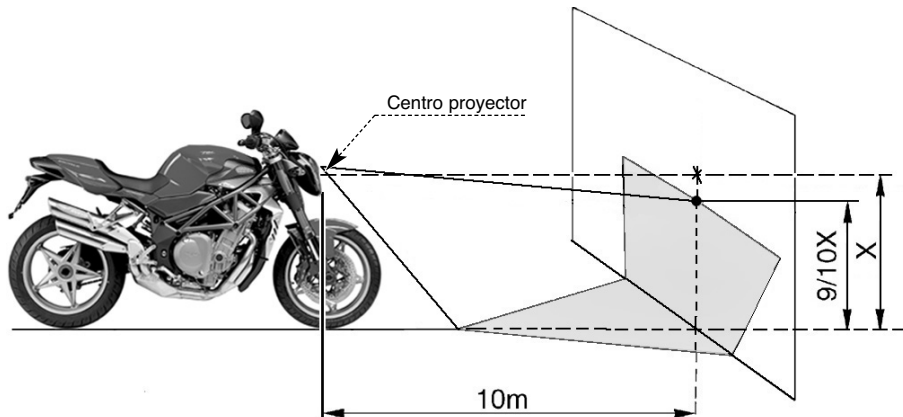



La regulación del faro delantero se puede realizar actuando en el tornillo que se muestra al lado. En sentido de las agujas del reloj: el faro se inclina hacia abajo. En sentido contrario a las agujas del reloj: el faro se inclina hacia arriba. La inclinación se puede variar de $\pm 4^\circ$ respecto a la posición estándar.

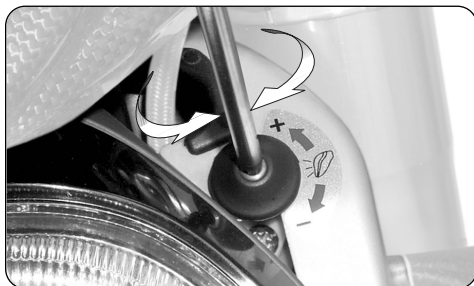
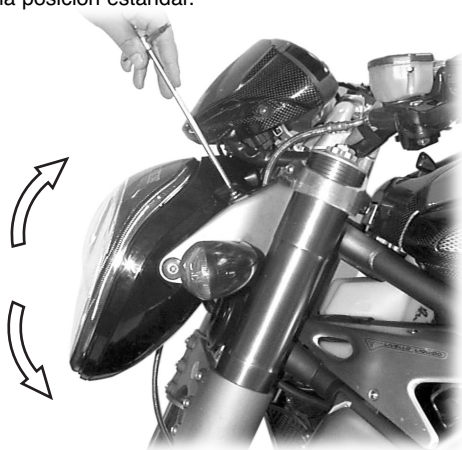



Nota informativa

MV Agusta S.p.A. está comprometida en una política de continuo mejoramiento de sus productos; por este motivo es posible encontrar ligeras diferencias entre el contenido de éste documento y el vehículo adquirido por Ustedes. Los modelos MV Agusta son exportados en muchos Países, en los cuales el Código del Transito y a los procedimientos de homologación son distintos a los nuestros.

Confiamos en Vuestra comprensión. MV Agusta S.p.A. considera por lo tanto necesario reservarse el derecho de aportar modificaciones a sus productos y a la documentación técnica en cualquier momento y sin ningún aviso previo.

Sugerimos para visitar a menudo el sitio Internet **www.mvagusta.it** para obtener informaciones y actualizaciones sobre los productos MV Agusta y la documentación relacionada.



Respetemos y defendamos el medioambiente

Todo lo que hacemos tiene repercusiones para todo el planeta y en sus recursos.

MV Agusta, a tutela de los intereses de la comunidad, sensibiliza los Clientes y los operadores de la asistencia técnica a adoptar una utilización del vehículo y de eliminación de sus partes, respetando plenamente las normativas vigentes en términos de contaminación del medio ambiente, eliminación y reciclaje de los desechos.

© 2006

Está prohibida la reproducción aunque sea parcial de éste documento sin el consentimiento escrito por MV Agusta S.p.A.

Part. n° 8000A9724

Edición n° 1 - Octubre 2006

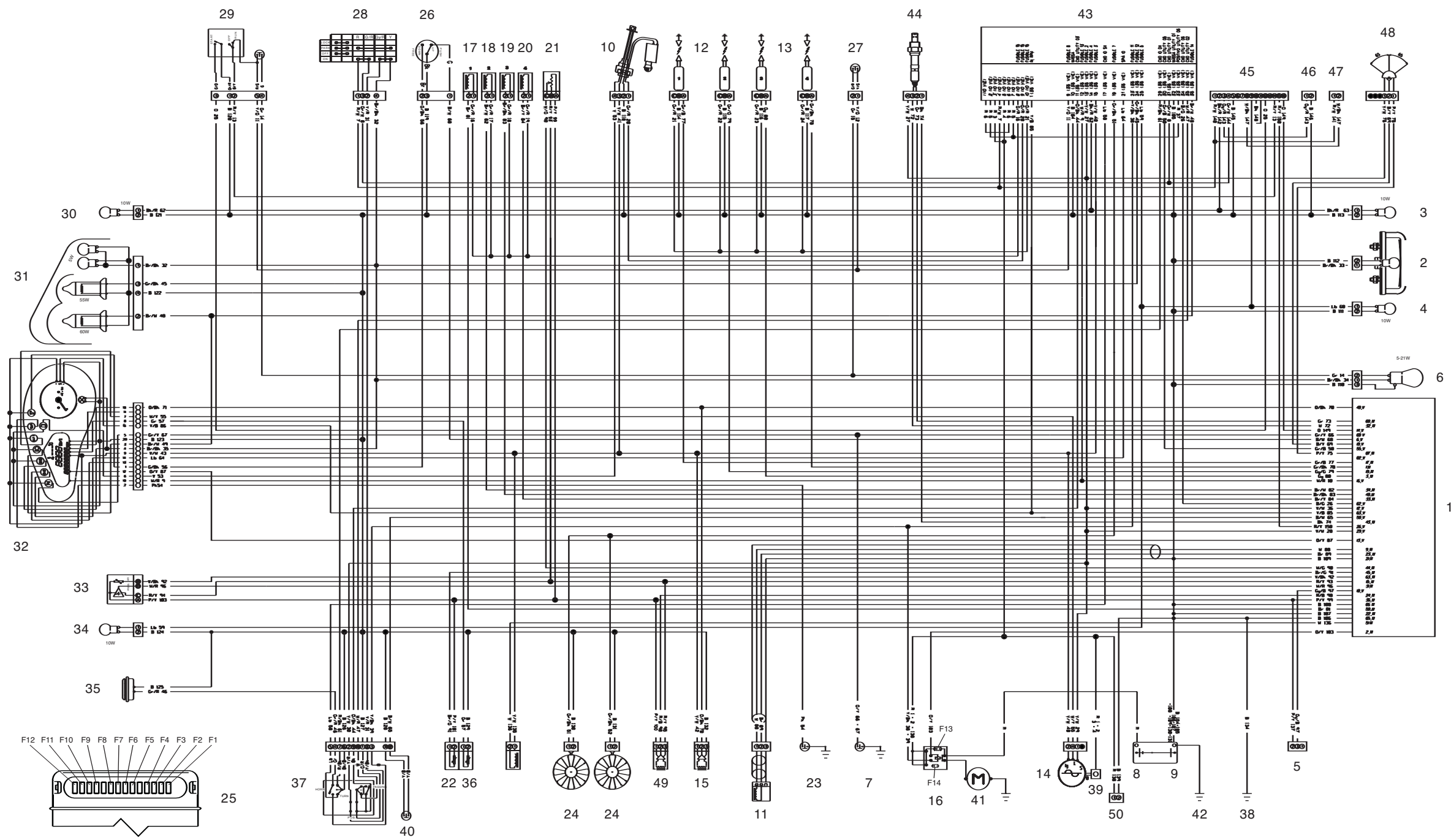

Legenda componenti	
Rif.	Descrizione
1	Centralina
2	Luce targa
3	Indicatore destro
4	Indicatore sinistro
5	Connettore diagnosi
6	Fanale posteriore - Stop
7	Interruttore folle
8-9	Batteria
10	Pompa - Sonda benzina
11	Sensore giri motore
12	Bobina
13	Bobina
14	Alternatore
15	Sensore velocità
16	Teleruttore
17-18	Iniettori
19-20	Iniettori

Legenda componenti	
Rif.	Descrizione
21	Potenzionetro farfalla
22	Sensore temperatura acqua per centralina
23	Interruttore olio
24	Elettroventola
25	Fusibili
26	Interruttore stampella laterale
27	Interruttore stop posteriore
28	Interruttore chiave
29	Interruttore di sicurezza e stop anteriore
30	Indicatore destro
31	Fanale anteriore
32	Cruscotto
33	Sensore pressione/temperatura aria
34	Indicatore sinistro
35	Avvisatore acustico
36	Sensore temperatura acqua per termometro cruscotto

Legenda componenti	
Rif.	Descrizione
37	Interruttore luci
38	Massa telaio - centralina
39	Ricarica batteria
40	Interruttore frizione
41	Motorino avviamento
42	Massa telaio
43	Centralina servizi
44	Sonda lambda
45	Connettore antifurto
46	Spia LED
47	Interruttore sella
48	Interruttore di caduta
49	Sensore giri camme
50	Connessione per kit ricarica batteria

Legenda colori cavi	
Lettera/e	Colore
R	Rosso
Y	Giallo
B	Blu
G	Verde
W	Bianco
Bk	Nero
P	Rosa
V	Viola
Sb	Azzurro
Gr	Grigio
O	Arancio
Br	Marrone

Nei colori combinati è indicato il colore di fondo e la marcatura. Es.: Br/Bk.

Legenda fusibili		
Rif.	Amperaggio (A)	Utilizzo
F1	5	Luce di posizione
F2	5	Sensore velocità
F3	5	Indicatore di direzione destro
F4	5	Indicatore di direzione sinistro
F5	15	Elettroventola
F6	5	Fanale posteriore-stop
F7	15	Relé "LATCH"
F8	7.5	Interruttore avviamento
F9	15	Faro anabbagliante
F10	5	Cruscotto
F11	15	Faro abbagliante
F12	15	Iniettori - Pompa carburante - Bobine
F13	40	Ricarica batteria
F14	40	Scorta per ricarica batteria

Parts list	
Ref.	Description
1	Power unit
2	Plate light
3	Turn indicator, right hand
4	Turn indicator, left hand
5	Diagnosis connector
6	Brake light
7	Neutral switch
8-9	Battery
10	Pump - Low fuel probe
11	Engine rpm sensor
12	Coil
13	Coil

Parts list	
Ref.	Description
14	Alternator
15	Speed sensor
16	Solenoid starter
17-18	Injectors
19-20	Injectors
21	Throttle potentiometer
22	Water temperature sensor for power unit
23	Oil switch
24	Heater fan
25	Fuses
26	Side stand switch
27	Rear brake switch

Parts list	
Ref.	Description
28	Key switch
29	Safety and front brake switch
30	Turn indicator, right hand
31	Front light
32	Display
33	Air pressure/temperature sensor
34	Turn indicator, left hand
35	Horn
36	Water temperature sensor for display thermometer
37	Light switch
38	Frame - power unit ground

Parts list	
Ref.	Description
39	Battery recharge
40	Clutch switch
41	Starter
42	Frame ground
43	Service power unit
44	Lambda sensor
45	Anti-theft device connection
46	LED indicator
47	Seat switch
48	Tilt sensor
49	Camshaft rpm sensor
50	Battery recharge kit connection

Wire colors list	
Letter(s)	Color
R	Red
Y	Yellow
B	Blue
G	Green
W	White
Bk	Black
P	Pink
V	Violet
Sb	Sky blue
Gr	Grey
O	Orange
Br	Brown

In combined colors, background and marking colors have been pointed out. E.g. : Br/Bk.

Fuses list		
Ref.	Amperage (A)	Application
F1	5	Position light
F2	5	Speed sensor
F3	5	RH turn indicator light
F4	5	LH turn indicator light
F5	15	Heater fan
F6	5	Brake light
F7	15	"LATCH" relay
F8	7.5	Starter switch
F9	15	Low beam
F10	5	Dashboard
F11	15	High beam
F12	15	Injectors - Fuel pump - Coils
F13	40	Battery recharge
F14	40	Battery recharge supply

Légende des composants	
Réf.	Description
1	Boîtier d'allumage
2	Eclaireur de plaque
3	Clignotant D
4	Clignotant G
5	Connecteur doagnostic
6	Feu arrière "Stop"
7	Contacteur de point mort
8-9	Batterie
10	Pompe - Sonde essence
11	Capteur compte tours
12	Bobine
13	Bobine

Légende des composants	
Réf.	Description
14	Alternateur
15	Capteur de vitesse
16	Télerupteur
17-18	Injecteurs
19-20	Injecteurs
21	Centrale clignotante
22	Capteur de température d'eau pour boîtier
23	Manocontact d'huile
24	Electrovanne
25	Fusibles
26	Contacteur de béquille latérale
27	Contacteur de stop arrière

Légende des composants	
Réf.	Description
28	Contacteur principal à clé
29	Contacteur de sûreté et stop avant
30	Clignotant D.
31	Feu avant
32	Tableau de bord
33	Capteur de pression / température d'air
34	Clignotant G.
35	Avertisseur sonore
36	Capteur de température d'eau pour thermomètre de bord
37	Contacteur d'éclairage
38	Masse cadre - boîtier

Légende des composants	
Réf.	Description
39	Charge batterie
40	Contacteur embrayage
41	Démarrreur électrique
42	Masse au cadre
43	Boîtier de services
44	Sonde Lambda
45	Connexion pour le dispositif anti-vol
46	Indicateur de LED
47	Contacteur de selle
48	Sonde d'inclinaison
49	Capteur compte tours arbre a cames
50	Connexion pour kit recharge de batterie

Légende couleur des câbles	
Lettre(s)	Couleur
R	Rouge
Y	Jaune
B	Bleu
G	Vert
W	Blanc
Bk	Noir
P	Rose
V	Violet
Sb	Bleu ciel
Gr	Gris
O	Orange
Br	Marron

Pour les couleurs combinés, la couleur de fond et le marquage sont indiqués. Par ex. Br/Bk.

Légende des fusibles		
Réf.	Ampérage (A)	Emploi
F1	5	Feu de position
F2	5	Capteur de vitesse
F3	5	Clignotant droit
F4	5	Clignotant gauche
F5	15	Manocontact d'huile
F6	5	Feu arrière "Stop"
F7	15	Relais "LATCH"
F8	7.5	Interrupteur démarreur
F9	15	Feu de croisement
F10	5	Tableau de bord
F11	15	Feu de route
F12	15	Injecteurs - Pompe carburant - Bobines
F13	40	Recharge batterie
F14	40	Réserve recharge batterie

Zeichenerklärung Bauteile	
Rif.	Beschreibung
1	Zündbox
2	Nummernschildbeleuchtung
3	Rechter Blinker
4	Linker Blinke
5	Diagnoseanschluß
6	Rücklicht - Bremslicht
7	Schalter Leerlauf
8-9	Batterie
10	Pumpe - Benzinstandgeber
11	Sensor Motordrehzahl
12	Spule
13	Spule

Zeichenerklärung Bauteile	
Rif.	Beschreibung
14	Lichtmaschine
15	Geschwindigkeitssensor
16	Fernrelais
17-18	Einspritzdüsen
19-20	Einspritzdüsen
21	Potentiometer Drosselventil
22	Temperaturfühler Wassertemperatur für Kontrollbox
23	Öldruckschalter
24	Gebälse
25	Sicherungen
26	Schalter Seitenständer
27	Hinterer Bremslichtschalter

Zeichenerklärung Bauteile	
Rif.	Beschreibung
28	Zündschloß
29	Sicherheitsschalter und vorderer Bremslichtschalter
30	Rechter Blinker
31	Vorderer Scheinwerfer
32	Armaturenbrett
33	Drucksensor/Lufttemperatur
34	Linker Blinker
35	Hupe
36	Temperaturfühler Wassertemperatur für Temperaturanzeige Armaturenbrett
37	Lichtschalter
38	Masse Rahmen - Kontrollbox

Zeichenerklärung Bauteile	
Rif.	Beschreibung
39	Batterieladung
40	Kupplungsschalter
41	Anlassermotor
42	Masse Rahmen
43	Dienst-Steuerung
44	Lambdasonde
45	Anschluß für diebstahlsichere Vorrichtung
46	LED Anzeige
47	Sattelschalter
48	Neigung-Sensor
49	Sensor Nockenwelledrehzahl
50	Batterieladung Bausatz Anschluß

Zeichenerklärung Kabelfarben	
Buchstabe(n)	Farbe
R	Rot
Y	Gelb
B	Blau
G	Grün
W	Weiß
Bk	Schwarz
P	Rose
V	Violett
Sb	Hellblau
Gr	Grau
O	Orange
Br	Braun

Bei Farbkombinationen wird die Grundfarbe und die Markierung angegeben. Z. B. Br/Bk.

Zeichenerklärung Sicherungen		
Nr.	Ampereleistung (A)	Einsatz
F1	5	Standlicht
F2	5	Geschwindigkeitssensor
F3	5	rechter Richtungsblinker
F4	5	linker Richtungsblinker
F5	15	Gebälse
F6	5	Rücklicht - Bremslicht
F7	15	LATCH Relais
F8	7.5	Startschalter
F9	15	Fahrlicht
F10	5	Armaturenbrett
F11	15	Fernlicht
F12	15	Einspritzdüsen - Kraftstoffpumpe - Spule
F13	40	Batterieladung
F14	40	Ersatz für Batterieladung

Leyenda Componentes	
Ref.	Descripción
1	Central
2	Luz matrícula
3	Indicador derecho
4	Indicador izquierdo
5	Conector diagnóstico
6	Faro trasero - Stop
7	Interruptor punto muerto
8-9	Batería
10	Bomba - Sonda gasolina
11	Sensor revoluciones motor
12	Bobina
13	Bobina

Leyenda Componentes	
Ref.	Descripción
14	Alternador
15	Sensor velocidad
16	Teleruptor
17-18	Inyectores
19-20	Inyectores
21	Potenciómetro mariposa
22	Sensor temperatura agua para central
23	Interruptor aceite
24	Electroventilador
25	Fusibles
26	Interruptor pata lateral
27	Interruptor stop trasero

Leyenda Componentes	
Ref.	Descripción
28	Interruptor llave
29	Interruptor de seguridad y stop delantero
30	Indicador derecho
31	Faro delantero
32	Cuadro mandos
33	Sensor presión/ temperatura aire
34	Indicador izquierdo
35	Claxon
36	Sensor temperatura agua para termómetro
37	Interruptor luces
38	Masa chasis - central

Leyenda Componentes	
Ref.	Descripción
39	Recarga batería
40	Interruptor embrague
41	Motor de arranque
42	Masa chasis
43	Centralita de servicio
44	Sonda Lambda
45	Conexión para el dispositivo antirrobo
46	Indicador del LED
47	Interruptor de la silla
48	Sensor de la inclinación
49	Sensor revoluciones árbol de levas
50	Conexión del kit recarga batería

Leyenda colores cables	
Letra/s	Color
R	Rojo
Y	Amarillo
B	Azul marino
G	Verde
W	Blanco
Bk	Negro
P	Rosa
V	Violeta
Sb	Azul
Gr	Gris
O	Naranja
Br	Marrón

En los colores combinados se indica el color de fondo y la marcación Ej. Br/Bk.

Leyenda fusibles		
Ref.	Amperaje (A)	Utilización
F1	5	Luz de posición
F2	5	Sensor velocidad
F3	5	Indicador de dirección der.
F4	5	Indicador de dirección izq.
F5	15	Electroventilador
F6	5	Faro trasero - Stop
F7	15	Relé "LATCH"
F8	7.5	Interruptor de arranque
F9	15	Faro luz de cruce
F10	5	Reloj Tablero
F11	15	Faro luz de carretera
F12	15	Inyectores - Bomba carburante - Bobinas
F13	40	Recarga batería
F14	40	Repuesto recarga batería

IT Fase 1: Effettuare la carica iniziale della batteria secondo le istruzioni riportate nella rispettiva confezione.

Fase 2: Inserire la chiave della motocicletta nella serratura posteriore. Ruotare la chiave in senso orario e contemporaneamente sollevare il sellino del passeggero. Procedere all'estrazione del sellino passeggero.

Fase 3: Ruotare il fermo del sellino pilota come mostrato in figura. Sollevare il sellino pilota ed estrarlo.

Fase 4: Inserire la batteria nell'apposito vano. Montare i 2 terminali positivi (+) sul relativo polo della batteria rispettando l'ordine indicato in figura. Prestare attenzione ai colori dei cavi in modo da disporli correttamente.

Fase 5: Ruotare la vite dei terminali positivi ed effettuare il serraggio ad una coppia pari a **7 ÷ 8 Nm**.

Fase 6: A montaggio avvenuto sistemare la **cuffia di protezione** sul polo positivo (vedi figura).

Fase 7: Montare i 2 terminali negativi (-) sul relativo polo della batteria rispettando la disposizione mostrata in figura.

Fase 8: Ruotare la vite dei terminali negativi ed effettuare il serraggio ad una coppia pari a **7 ÷ 8 Nm**.

Fase 9: ATTENZIONE: Alla fine dell'operazione di montaggio, assicurarsi che il cavo del terminale positivo sia posizionato all'interno della struttura del telaio posteriore (vedi figura sul retro). Rimontare il sellino pilota e passeggero seguendo in senso inverso le operazioni descritte nelle fasi 2-3.

GB Phase 1: Perform the initial charge of the battery according to the instruction sheet enclosed in its package.

Phase 2: Insert the motorcycle key in the rear lock. Rotate the key clockwise while lifting the pillion. Remove the pillion.

Phase 3: Rotate the driver's saddle catch as shown in the figure. Lift the driver's saddle and remove it.

Phase 4: Insert the battery in its proper compartment. Fit the 2 positive terminals (+) on the corresponding battery pole, respecting their disposition as shown in the figure. Pay attention to the colours of the cables in order to correctly place them.

Phase 5: Rotate the positive terminals screw and tighten it at a torque equal to **7 ÷ 8 Nm**.

Phase 6: Afterwards, fit the **protective cap** on the positive pole (see figure).

Phase 7: Fit the 2 negative terminals (-) on the corresponding battery pole, respecting their disposition as shown in the figure.

Phase 8: Rotate the negative terminals screw and tighten it at a torque equal to **7 ÷ 8 Nm**.

Phase 9: WARNING: When the assembly operations have been completed, make sure that the positive terminal cable is placed within the rear frame (see figure on the reverse side). Replace the driver's saddle and the pillion by inversely performing the operations described in the phases from 2 to 3.

FR Etape 1: Exécutez la charge initiale de la batterie selon les instructions incluses en son paquet.

Etape 2: Introduire la clé de la motocyclette dans la serrure postérieure. Tourner la clé dans le sens des aiguilles d'une montre et simultanément soulever la selle du passager. Extraire la selle du passager.

Etape 3: Tourner l'arrêt de la selle du pilote en respectant la disposition indiquée sur la figure. Soulever la selle du pilote et l'extraire.

Etape 4: Introduire la batterie dans son compartiment. Monter les 2 bornes positives (+) sur le pôle correspondant de la batterie en respectant l'ordre indiqué dans la figure. Prêter attention aux couleurs des câbles de façon à les disposer correctement.

Etape 5: Tourner la vis des bornes positives et la serrer à un couple égal à **7 ÷ 8 Nm**.

Etape 6: Une fois le montage accompli, placer le **protecteur** sur le pôle positif (voir figure).

Etape 7: Monter les 2 bornes négatives (-) sur le pôle correspondant de la batterie en respectant la disposition indiquée sur la figure.

Etape 8: Tourner la vis des bornes négatives et la serrer à un couple égal à **7 ÷ 8 Nm**.

Etape 9: ATTENTION: A la fin de l'opération de montage, s'assurer que le câble de la borne positive se trouve à l'intérieur de la structure du châssis postérieur (voir figure sur le derrière). Remonter la selle du pilote et du passager en procédant dans l'ordre inverse par rapport aux opérations décrites aux étapes de 2 à 3.

DE Phase 1: Führen Sie die Batterieaufladung, nach Instruktionen aus, die in seinem Paket eingeschlossen sind.

Phase 2: Den Motorradschlüssel in das hintere Schloss einstecken. Den Schlüssel in Uhrzeigersinn drehen und gleichzeitig den Beifahrersitz aufheben. Den Beifahrersitz herausnehmen.

Phase 3: Drehen Sie den Fahrersitzblock, dabei die in die Figur gezeigte Reihenfolge einhalten. Den Fahrersitz aufheben und herausnehmen.

Phase 4: Die Batterie in den dazu geeigneten Raum anbringen. Die zwei Plusendverschlüsse (+) auf den jeweiligen Pol der Batterie unter Berücksichtigung der auf der Abbildung angegebenen Anordnung montieren. Bei Kabelanordnung auf Kabelfarben achten.

Phase 5: Die Schraube der Plusendverschlüsse drehen und mit einem Drehmoment von **7 ÷ 8 Nm** festziehen.

Phase 6: Nach der Montage den **Schutzkasten** auf dem Pluspol anlegen (siehe Abbildung).

Phase 7: Die zwei Minusendverschlüsse (-) auf den jeweiligen Pol der Batterie bei Berücksichtigung der auf der Abbildung angezeigten Anordnung montieren.

Phase 8: Die Schraube der Minusendverschlüsse drehen und mit einem Drehmoment von **7 ÷ 8 Nm** festziehen.

Phase 9: ACHTUNG: Am Ende des Montagevorgangs überprüfen ob das Kabel des Plusendverschlusses sich in der Hinterrahmenstruktur befindet (siehe Abbildung auf der Blattrück). Beim Wiedereinbau des Fahrer- und Beifahrersitzes die unter Phasen von 2 bis 3 angegebenen Vorgänge in umgekehrter Reihenfolge durchführen.

ES Fase 1: Realice la carga inicial de la batería según las instrucciones incluidas en su paquete.

Fase 2: Introducir la llave de la motocicleta en la cerradura posterior. Girar la llave en sentido de las agujas del reloj y al mismo tiempo levantar el sillín del pasajero. Proceder a la extracción del sillín del pasajero.

Fase 3: Girar el sujetador del sillín del piloto según lo demostrado en la figura. Levantar el sillín del piloto y extraerlo.

Fase 4: Colocar la batería en su alojamiento. Montar los 2 terminales positivos (+) en el correspondiente polo de la batería respetando el orden indicado en la figura. Prestar atención a los colores de los cables para colocarlos correctamente.

Fase 5: Girar el tornillo de los terminales positivos y efectuar el apriete a un par igual a **7÷8 Nm**.

Fase 6: Después del montaje colocar la **protección** en el polo positivo (ver figura).

Fase 7: Montar los 2 terminales negativos (-) en el correspondiente polo de la batería respetando la disposición mostrada en la figura.

Fase 8: Girar el tornillo de los terminales negativos y efectuar el apriete a un par igual a **7÷8 Nm**.

Fase 9: ATENCION: Al final de las operaciones de montaje, cerciorarse que el cable del terminal positivo se encuentre ubicado en el interior de la estructura del chasis posterior (ver la figura en el dorso). Montar nuevamente el sillín piloto y pasajero siguiendo el sentido contrario a las operaciones descritas en las fases a partir del 2 a 3.

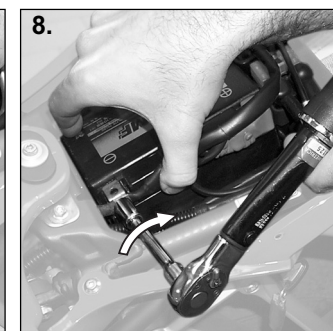
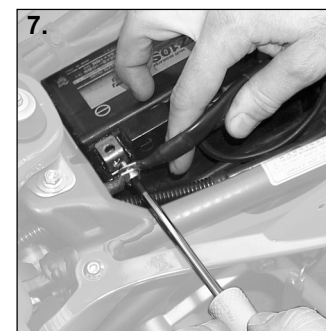
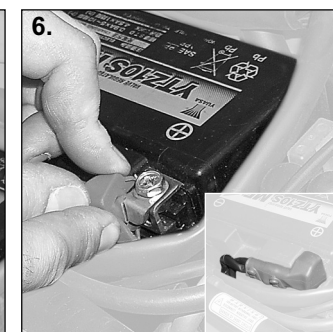
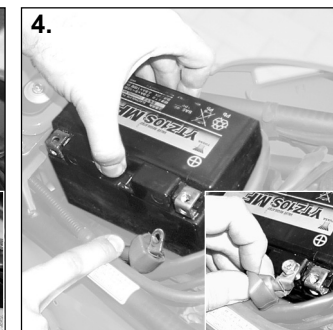
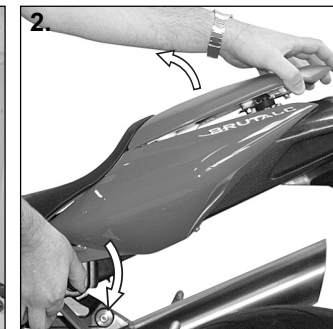
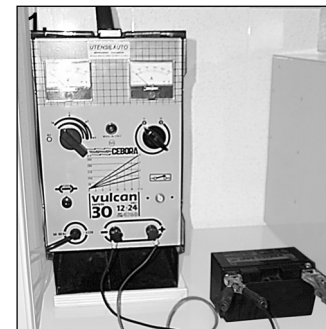

CAVO NEGATIVO (-)
NEGATIVE CABLE (-)
CABLE NEGATIF (-)
MINUSKABEL (-)
CABLE NEGATIVO (-)

POLO NEGATIVO (-)
NEGATIVE POLE (-)
POLE NEGATIF (-)
MINUSPOL (-)
POLO NEGATIVO (-)

CAVO NEGATIVO (-)
NEGATIVE CABLE (-)
CABLE NEGATIF (-)
MINUSKABEL (-)
CABLE NEGATIVO (-)

CAVO POSITIVO (+)
POSITIVE CABLE (+)
CABLE POSITIF (+)
PLUSKABEL (+)
CABLE POSITIVO (+)

POLO POSITIVO (+)
POSITIVE POLE (+)
POLE POSITIF (+)
PLUSPOL (+)
POLO POSITIVO (+)

CAPPUCCIO DI PROTEZIONE
PROTECTIVE CAP
CAPUCHON DE PROTECTION
SCHUTZKASTEN
CAPUCHON DE PROTECCION

CAVO POSITIVO (+)
POSITIVE CABLE (+)
CABLE POSITIF (+)
PLUSKABEL (+)
CABLE POSITIVO (+)





- Dispositivo idraulico di frenatura in compressione (Bassa velocità)
- Compression damping hydraulic device (Low speed)
- Dispositif hydraulique de freinage en compression (Vitesse basse)
- Hydraulische Kompressionsbremse (Niedrige Gänge)
- Dispositivo hidráulico de frenado en compresión (Baja velocidad)

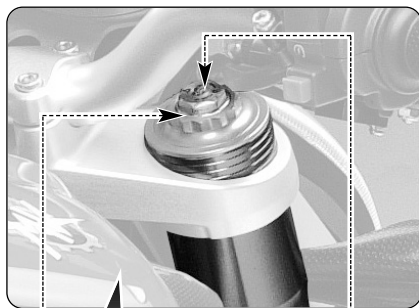

- Dispositivo idraulico di frenatura in estensione
- Rebound damping hydraulic device
- Dispositif hydraulique de freinage en détente
- Hydraulische Ausdehnungsbremse
- Dispositivo hidráulico de frenado en extensión

- Dispositivo idraulico di frenatura in compressione (Alta velocità)
- Compression damping hydraulic device (High speed)
- Dispositif hydraulique de freinage en compression (Vitesse élevée)
- Hydraulische Kompressionsbremse (Hohe Gänge)
- Dispositivo hidráulico de frenado en compresión (alta velocidad)

- Precarico molla
- Spring preload
- Précharge du ressort
- Federvorspannung
- Precarga muelle

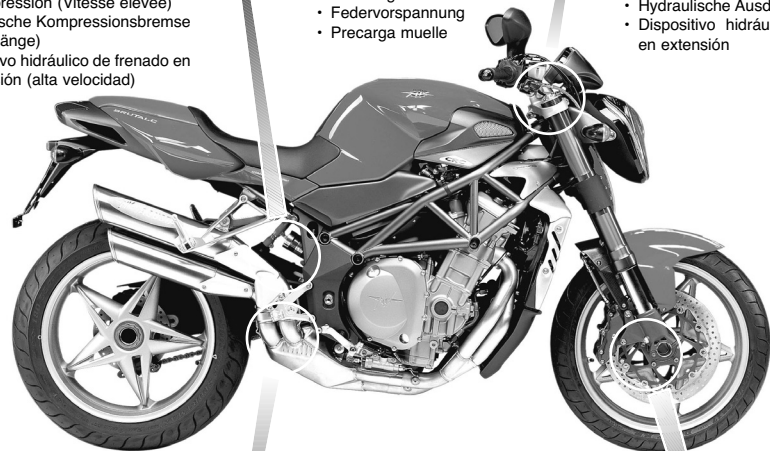

- Dispositivo idraulico di frenatura in estensione
- Rebound damping hydraulic device
- Dispositif hydraulique de freinage en détente
- Hydraulische Ausdehnungsbremse
- Dispositivo hidráulico de frenado en extensión

- Dispositivo idraulico di frenatura in compressione
- Compression damping hydraulic device
- Dispositif hydraulique de freinage en compression
- Hydraulische Kompressionsbremse
- Dispositivo hidráulico de frenado en compresión

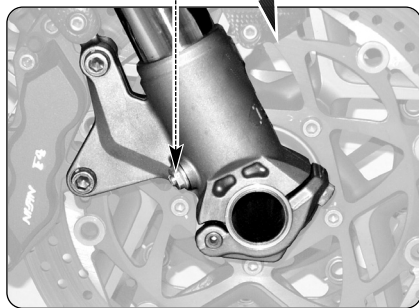
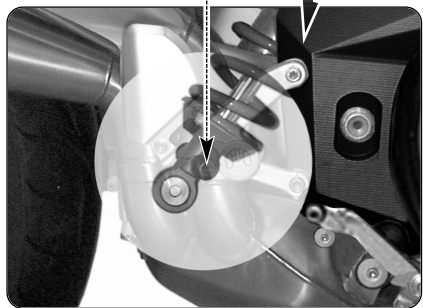

		Brutale 910 S	
		Tipo di assetto - Type of geometry - Type d'assiette - Einstellungsart - Tipo de equilibrado	
		Su strada On road Sur route Auf Straße En la carretera	In pista On race circuit En circuit de course Auf Rennstrecken En circuito
Sospensione anteriore Front suspension Suspension avant Vordere Federung Suspensión delantera		2 giri turns tours Drehzahl revoluciones	3 giri turns tours Drehzahl revoluciones
Precarico molla Spring preload Précharge du ressort Federvorspannung Precarga muelle			
Freno in estensione Rebound damping Frein en détente Ausdehnungsbremse Freno en extensión		14 scatti clicks emboîtements Rasten disparos	11 scatti clicks emboîtements Rasten disparos
Freno in compressione Compression damping Frein en compression Kompressionsbremse Freno en compresión		9 scatti clicks emboîtements Rasten disparos	7 scatti clicks emboîtements Rasten disparos
Sospensione posteriore Rear suspension Suspension arrière Hintere Federung Suspensión trasera			
	Frenatura in estensione Rebound damping Freinage en détente Ausdehnungsbremse Frenado en extensión	14 scatti clicks emboîtements Rasten disparos	10 scatti clicks emboîtements Rasten disparos
	Frenatura in compressione Compression damping Freinage en compression Kompressionsbremse Frenado en compresión	0 scatti clicks emboîtements Rasten disparos	12 scatti clicks emboîtements Rasten disparos
	Bassa velocità Low speed Vitesse basse Niedrige Gänge Baja velocidad	14 scatti clicks emboîtements Rasten disparos	10 scatti clicks emboîtements Rasten disparos
	Alta velocità High speed Vitesse élevée Hohe Gänge Alta velocidad		
Con passeggero * - With passenger * - Avec passager * - Mit Beifahrer * - Con pasajero *	Frenatura in estensione Rebound damping Freinage en détente Ausdehnungsbremse Frenado en extensión	14 scatti clicks emboîtements Rasten disparos	-
	Frenatura in compressione Compression damping Freinage en compression Kompressionsbremse Frenado en compresión	18 scatti clicks emboîtements Rasten disparos	-
	Bassa velocità Low speed Vitesse basse Niedrige Gänge Baja velocidad	14 scatti clicks emboîtements Rasten disparos	-
	Alta velocità High speed Vitesse élevée Hohe Gänge Alta velocidad		

(*) : Per l'utilizzo del veicolo con passeggero si consiglia di aumentare il precarico molla dell'ammortizzatore posteriore di 6 giri. Questa operazione deve essere tassativamente eseguita da un concessionario MV Agusta. - To use the vehicle with passenger, we suggest to increase the rear suspension spring preload of 6 turns. This operation must be performed only by a MV Agusta authorized dealer. - Pour utiliser le véhicule avec le passager, nous suggérons d'augmenter la précharge de ressort de la suspension arrière de 6 tours. Cette intervention doit être impérativement effectuée par un concessionnaire officiel MV Agusta. - Für das Verwenden des Trägers mit dem Beifahrer, schlagen wir vor, um die hintere Federungsfedervorspannung von 6 Umdrehungen zu erhöhen. Änderungen an der Trimmlage dürfen ausschließlich von MV Agusta Vertragshändlern vorgenommen werden. - Para usar el vehículo con el pasajero, sugerimos el aumento de la precarga del resorte de la suspensión posterior de 6 vueltas. Dicha intervención debe ser realizada por un concesionario oficial MV Agusta.

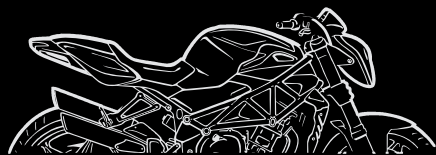

Motorcycle Art



MV AGUSTA S.p.A. - Via Nino Bixio, 8
21024 - Cassinetta di Biandronno (VA) - ITALY
www.mvagusta.it Part. N. 8000A9724 Edizione n°1

