



Manuale dell'Utente
User's manual

BRUTALE
990R

MV AGUSTA



Manuale dell'utente
Versione Italiana

Gentile cliente,

La ringraziamo per la fiducia accordataci e ci congratuliamo con Lei per la Sua nuova Brutale 990 R. MV Agusta, grazie alla passione e all'impegno dei suoi tecnici, si ripropone agli appassionati con un prodotto caratterizzato da una inedita veste estetica accostata ad una raffinata ciclistica: elementi che hanno contraddistinto tutte le creazioni del marchio MV Agusta nell'arco della sua gloriosa storia.

Il risultato è una moto esclusiva che, per le sue caratteristiche estetiche e funzionali e le innumerevoli innovazioni tecniche, si pone al di sopra dei prodotti di più alto profilo che il mercato motociclistico possa oggi offrire.

Le soluzioni adottate conferiscono, infatti, ad Brutale 990 R quell'inconfondibile carattere che la lega agli altri modelli della famiglia MV Agusta, consolidando una filosofia progettuale che privilegia la costante ricerca, l'innovazione tecnologica e l'amore per il dettaglio dando la possibilità, a chi vive la propria passione motociclistica in piena libertà, di possedere un oggetto unico al mondo che si pone con prepotenza come riferimento di livello mondiale.

Se desiderasse ulteriori informazioni, non esiti a contattare il Servizio Assistenza Clienti MV Agusta.

Buon divertimento!

*Claudio Castiglioni
Presidente
MV Agusta*



INDICE GENERALE

<i>cap.</i>	<i>Descrizione argomenti</i>	<i>pag.</i>
1	INFORMAZIONI GENERALI	5
1.1.	Scopo del manuale	5
1.2.	Simbologia	6
1.3.	Contenuto del supporto digitale	7
1.4.	Dati di identificazione	8
2	INFORMAZIONI SULLA SICUREZZA	11
2.1.	Uso consentito del veicolo	11
2.2.	Manutenzione	11
2.3.	Accessori e modifiche	12
2.4.	Carico veicolo	12
3	COMANDI E STRUMENTI	14
3.1.	Posizione comandi e strumenti	14
3.2.	Cavalletto laterale	16
3.3.	Comandi al manubrio lato sinistro	17
3.4.	Comandi al manubrio lato destro	19
3.5.	Interruttore accensione e bloccasterzo	22
3.6.	Comando cambio	26
3.7.	Strumentazione e spie	27
3.7.1.	Spie luminose di indicazione	28
3.7.2.	Display multifunzione/Display cambio e temperatura acqua	29
3.8.	Tabella lubrificanti e liquidi	30

<i>cap.</i>	<i>Descrizione argomenti</i>	<i>pag.</i>
4	USO	31
4.1.	Uso della motocicletta	31
4.2.	Rodaggio	32
4.3.	Avviamento motore	34
4.4.	Selezione e modifica delle funzioni display	38
4.4.1.	Selezione funzioni display	39
4.4.2.	Azzeramento delle funzioni contachilometri parziali	43
4.4.3.	Regolazione delle unità di misura	47
4.4.4.	Cronometro	49
4.4.5.	Modalità TC	57
4.4.6.	Modalità IMMOBILIZER	58
4.4.7.	Selezione della mappatura centralina	61
4.4.8.	Messaggi di errore/malfunzionamento	62
4.5.	Rifornimento carburante	65
4.6.	Accesso al vano portaoggetti	67
4.7.	Sosta della motocicletta	68
5	REGOLAZIONI	70
5.1.	Elenco regolazioni	70
5.2.	Tabella delle regolazioni	73
5.3.	Regolazione leva freno anteriore	74
5.4.	Regolazione leva frizione	74



INDICE GENERALE

<i>cap.</i>	<i>Descrizione argomenti</i>	<i>pag.</i>
5.5.	Regolazione specchietti retrovisori	75
5.6.	Regolazione sospensione anteriore	76
5.6.1.	Prearico molla	77
5.6.2.	Dispositivo idraulico di frenatura in estensione (sospensione anteriore)	77
5.6.3.	Dispositivo idraulico di frenatura in compressione (sospensione anteriore)	78
5.7.	Regolazione sospensione posteriore	79
5.7.1.	Dispositivo idraulico di frenatura in estensione (sospensione posteriore)	80
5.8.	Regolazione proiettore anteriore	81



1.1. Scopo del manuale

Il presente Manuale fornisce le informazioni necessarie per un uso corretto e sicuro della moto.

Assieme al Manuale viene fornito un Quick Manual tascabile nel quale sono riportate le informazioni minime essenziali per l'uso del veicolo.

Il Manuale viene fornito anche in formato elettronico (.pdf) sul presente supporto digitale e può essere stampato o visualizzato su un qualsiasi PC, sia dotato di sistema Windows che Mac.

Vi raccomandiamo di leggere attentamente il Manuale prima di utilizzare la moto e di sincerarvi che chiunque utilizzi la moto abbia prima fatto lo stesso.

Vi raccomandiamo, infine, di portare sempre con Voi il Quick Manual completandolo con i dati identificativi vostri e della motocicletta.



Copyright
MV AGUSTA Motor Spa
Tutti i diritti riservati



1.2. Simbologia

Le parti di testo di particolare importanza, relative alla sicurezza della persona e all'integrità della motocicletta, sono evidenziate con i seguenti simboli:



Pericolo - Attenzione: la mancata o incompleta osservanza di queste prescrizioni può comportare pericolo grave per la propria incolumità e per quella di altre persone.



Cautela - Precauzione: la mancata o incompleta osservanza di queste prescrizioni può comportare un rischio di danni alla motocicletta.

Per indicare le persone autorizzate allo svolgimento delle operazioni di regolazione e/o manutenzione, esse sono contraddistinte dai seguenti simboli:



Informazioni sulle operazioni consentite al motociclista.



Informazioni sulle operazioni che devono essere svolte solo dal personale autorizzato.

Per evidenziare ulteriori informazioni vengono utilizzati i seguenti simboli:



Il simbolo  indica la necessità di utilizzare un attrezzo od un'attrezzatura specifica per il corretto svolgimento dell'operazione descritta.



Il simbolo “ § ” indica il rimando al capitolo identificato dal numero che lo segue.



1.3. Contenuto del supporto digitale

Nel presente supporto digitale troverete, oltre a questo Manuale, il Manuale di Manutenzione, il Quick Manual (di cui viene fornita anche la versione stampata), la Guida delle Concessionarie, il Libretto di Garanzia ed il Catalogo Parti Speciali MV Agusta.

Al momento della consegna della moto, il Vs. Concessionario vi ha consegnato il Certificato di Garanzia e Pre-Consegna.

Vi preghiamo di conservarlo unitamente ai documenti della moto ed ai futuri tagliandi di manutenzione che vi verranno via via consegnati in occasione degli interventi previsti.

IMPORTANTE

La copia del Certificato di Garanzia e Pre-Consegna destinata alla MV Agusta deve essere compilata dal Concessionario e resa alla fabbrica entro 10 gg. dalla data di immatricolazione.

Le copie dei tagliandi di manutenzione raccomandata devono essere sempre compilati dal Concessionario e resi alla MV Agusta entro 10 gg. dalla data di esecuzione degli interventi.



1

2) numero di matricola motore

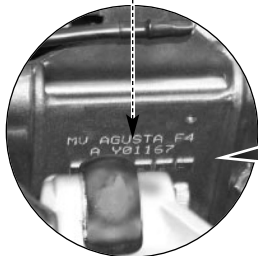

3) dati di omologazione

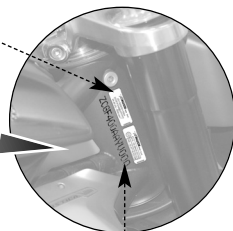

1) numero di matricola telaio



1.4. Dati di identificazione

- 1) numero di matricola telaio
- 2) numero di matricola motore
- 3) dati di omologazione

► Identificazione motocicletta

La motocicletta è identificata dal numero di matricola del telaio. Per ordinare le parti di ricambio, oltre a questo numero, può essere necessario indicare il numero di matricola motore, il codice colore e il numero di identificazione chiave.

Si consiglia di annotare i dati principali negli spazi sotto riportati.

TELAIO N.: _____

MOTORE N.: _____



► Identificazione chiave della motocicletta

Viene fornita, in duplice copia, una chiave da utilizzare sia per l'avviamento che per l'azionamento di tutte le serrature. Custodire in luogo sicuro la copia di scorta.

La conoscenza del numero di identificazione chiave è essenziale nel caso in cui si renda necessario richiedere un duplicato della chiave a ricambio. Il numero di identificazione chiave è riportato sulla MV Code Card fornita in dotazione insieme alle chiavi di avviamento.

► Identificazione combinazione colori motocicletta

Il codice colore è indispensabile per ordinare le parti di ricambio della carrozzeria. Esso si trova nella parte inferiore destra del serbatoio benzina.

Per accedere alla targhetta codice colore, è necessario rimuovere il fianchetto serbatoio destro.

Tirare la parte posteriore del fianchetto serbatoio destro verso l'esterno come mostrato in figura.



1

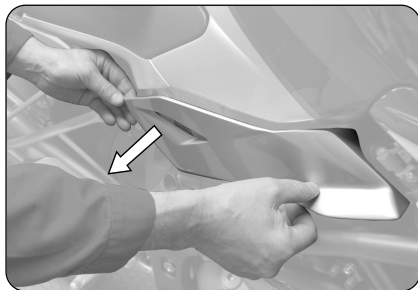



1

Procedere alla rimozione del fianchetto serbatoio destro sfilandolo verso la parte posteriore della moto.

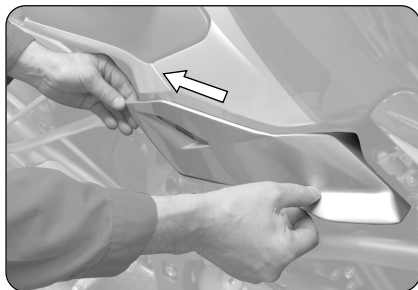

Dopo avere rimosso il fianchetto serbatoio, è possibile accedere alla targhetta codice colore posta sul serbatoio. Su questa targhetta è possibile individuare il codice colore della motocicletta, il quale determina la colorazione delle parti della carrozzeria.

Si consiglia di annotare il codice colore della motocicletta nel seguente spazio:

CODICE COLORE :

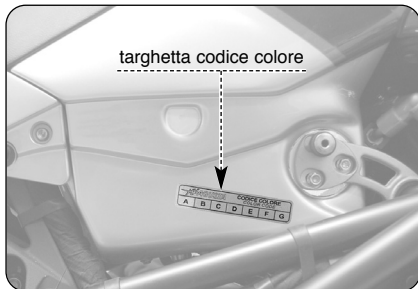



2.1. USO CONSENTITO DEL VEICOLO

La Vs. motocicletta e' stata progettata per un utilizzo esclusivamente stradale ed autostradale.



ATTENZIONE

Saltuariamente e' possibile utilizzare la moto in pista in occasioni non competitive.

In tale caso, tuttavia, a causa delle maggiori sollecitazioni a cui in tale specifico utilizzo la moto e' sottoposta, si raccomanda di far verificare da un Centro Assistenza MV Agusta le condizioni della moto prima e dopo l'uso.

Ogni altro utilizzo e' proibito ed espressamente escluso.

Potete trovare ulteriori informazioni circa l'uso della moto nella sezione 4 del presente Manuale.

2.2. MANUTENZIONE

Per garantire la massima efficienza ed affidabilità del veicolo è essenziale eseguire gli interventi manutentivi previsti nel Manuale di Manutenzione.

MV Agusta raccomanda che tutti gli interventi di manutenzione siano effettuati solo da personale specializzato appartenente ad un Centro Assistenza MV Agusta.

Laddove, viceversa, decidiate di far eseguire gli interventi di manutenzione da officine terze, dovette farVi confermare che le stesse abbiano la capacita' e gli strumenti specifici necessari all'esecuzione di tali interventi.



ATTENZIONE

La garanzia MV Agusta potrebbe non operare laddove officine terze abbiano effettuato interventi sulla moto in modo difforme da quanto previsto dalle Circolari Tecniche e nei relativi Manuali di Officina MV Agusta.



2.3. ACCESSORI E MODIFICHE



ATTENZIONE

MV Agusta vieta di apportare qualsiasi modifica alle proprie motociclette.

Questo è necessario al fine di salvaguardare la sicurezza dei suoi Clienti.

È tuttavia possibile personalizzare la Vs. motocicletta attingendo dal ricco catalogo Accessori MV Agusta.



ATTENZIONE

L'installazione di alcuni di questi accessori può invalidare l'omologazione della moto e, pertanto, comportare la sua non ulteriore utilizzabilità su strada pubblica.

In caso di dubbio Vi consigliamo di consultarVi con il vostro Concessionario MV Agusta di fiducia per decidere quali accessori siano più adatti alle Vs. esigenze.

2.4. CARICO VEICOLO

Il veicolo è progettato per l'impiego da parte del pilota e di un eventuale passeggero.

Per un utilizzo in piena sicurezza e nel rispetto delle norme del codice stradale è obbligatorio non superare mai la massa massima tecnicamente ammissibile del veicolo, il cui valore è di seguito riportato:

BRUTALE 990 R

Peso massimo totale	370 kg
Peso massimo trasportabile	180 kg

Il peso massimo totale rappresenta la somma dei seguenti pesi, secondo la direttiva europea CEE 92/61:

- peso del motociclo;
- peso del pilota;
- peso del passeggero;
- peso del carico e degli accessori.

**ATTENZIONE**

Dato che il carico ha un impatto enorme sulla manovrabilità, la frenata, le prestazioni e le caratteristiche di sicurezza del vostro mezzo, tenere sempre presenti le seguenti precauzioni.

- **NON SOVRACCARICARE MAI IL MOTOCICLO!** L'uso di un motociclo sovraccaricato può provocare danneggiamenti dei pneumatici, perdite del controllo o infortuni gravi. Verificare che il peso totale del pilota, del passeggero, del carico e degli accessori non superi il carico massimo specificato per il motociclo.



3.1. Posizione comandi e strumenti

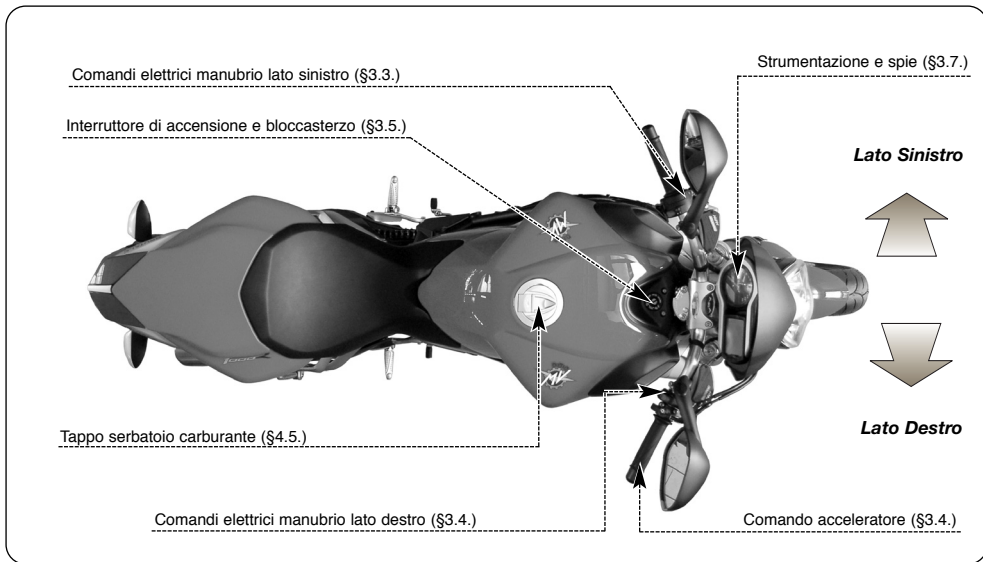



Leva comando freno anteriore (§5.1.)

Leva comando frizione (§5.1.)

Specchietti retrovisori (§5.1.)

Pedana poggiatesta per passeggero

Pedana poggiatesta per passeggero

Maniglie di sostegno per passeggero

Maniglie di sostegno per passeggero

Leva comando freno posteriore (§5.1.)

Pedana poggiatesta

Pedana poggiatesta

Leva comando cambio (§3.6. e §5.1.)

Cavalletto laterale (§3.2.)

3



3.2. Cavalletto laterale

Il cavalletto laterale è dotato di un interruttore di sicurezza che impedisce la partenza con il cavalletto abbassato.

Nel caso in cui a motore avviato e nella condizione di cavalletto abbassato si azioni il cambio per porsi in movimento, l'interruttore interrompe la corrente al motore provocandone l'arresto.

Nel caso in cui la moto si trovi invece in condizione di stazionamento (cavalletto abbassato) e con un rapporto del cambio inserito, l'interruttore impedisce l'avviamento del motore evitando ogni rischio di caduta accidentale del veicolo.



Interruttore di sicurezza

Cavalletto laterale

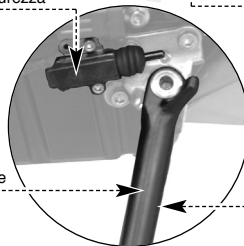

Cavalletto laterale

Doppia molla di richiamo



3.3. Comandi al manubrio lato sinistro

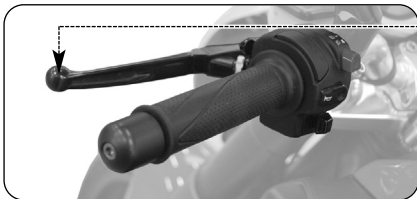

Leva frizione

Accostare o allontanare dalla manopola per comandare la frizione.

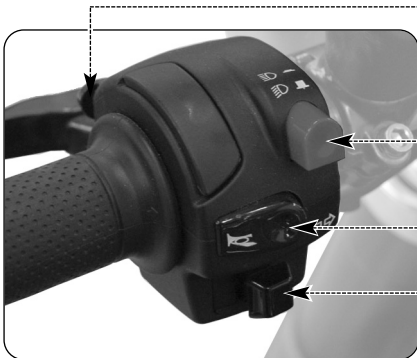

Pulsante lampeggio fari

Premere il pulsante a ripetizione.

Pulsante abbagliante/anabbagliante

Pulsante in fuori  : anabbagliante 

Pulsante in dentro  : abbagliante 

Pulsante avvisatore acustico

Premere per attivare l'avvisatore acustico.

Leva indicatori di direzione

Spostando la leva a destra o a sinistra si attivano gli indicatori di direzione destri o sinistri. La leva torna al centro; premere per disattivare gli indicatori.



Pulsante Lampeggio Faro

Questa funzione serve a richiamare l'attenzione degli altri utenti della strada in caso di possibili situazioni di pericolo; con l'abbagliante acceso tale funzione non è attiva.

Pulsante Abbagliante/Anabbagliante

Normalmente viene attivata la funzione anabbagliante; quando le condizioni di traffico e di percorso lo consentono, può essere attivata la funzione abbagliante agendo sul pulsante.

Leva Indicatori di Direzione

Questa funzione permette di segnalare agli altri utenti della strada l'intenzione di cambiare direzione o corsia di marcia.



ATTENZIONE

Il mancato uso o la mancata disattivazione degli indicatori di direzione al momento opportuno può essere causa di incidenti; gli altri utenti della strada potrebbero infatti trarre conclusioni sbagliate riguardo all'effettivo tragitto del veicolo. Azionare sempre gli indicatori di direzione prima di svoltare o cambiare corsia.

Accertarsi poi di disattivare gli indicatori non appena effettuata la suddetta manovra.

Pulsante Avvisatore Acustico

Questa funzione serve a richiamare l'attenzione degli altri utenti della strada in caso di possibili situazioni di pericolo.

Leva Frizione

Questa leva, attraverso un dispositivo a controllo idraulico, consente l'innesto ed il disinnesto della frizione.



3.4. Comandi al manubrio lato destro

Leva freno anteriore

Avvicinare alla manopola per azionare il freno anteriore.

Comando acceleratore

Ruotare per regolare l'alimentazione del motore.

Leva avviamento a freddo del motore (Choke)

Ruotare in senso orario per l'avviamento a freddo del motore. Dopo alcuni secondi riportare la leva nella sua posizione iniziale.

Interruttore stop motore

Se azionato arresta il motore e ne impedisce l'avviamento.

Pulsante avviamento motore

Premuto avvia il motore. Va rilasciato appena avviato. Con motore avviato, ripremendo, si selezionano le funzioni del display.

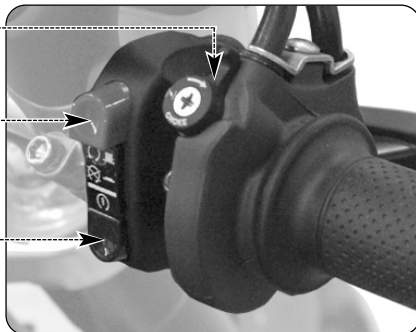
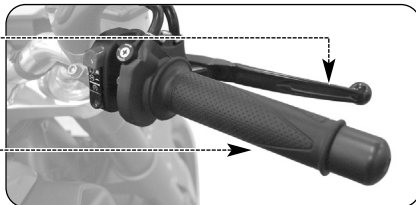

**Interruttore Stop Motore**

Questa funzione permette di arrestare il motore in caso di emergenza; in questo modo viene disattivato il circuito di accensione impedendo il riavvio del motore. Per poter effettuare l'avviamento riportare il pulsante in posizione di riposo.

NOTA

In condizioni normali non utilizzare questo dispositivo per l'arresto del motore.

Pulsante Avviamento Motore

Questo dispositivo consente l'avviamento del motore; inoltre a motore avviato esso permette di selezionare le funzioni del display presente nella strumentazione di bordo.

**CAUTELA**

Per evitare danni all'impianto elettrico non tenere premuto il pulsante per un tempo superiore ai 5 secondi consecutivi.

Se il motore non si avvia dopo alcuni tentativi, consultare il capitolo "GUASTI" nel presente manuale.

Leva Avviamento a freddo del Motore (Choke)

Il dispositivo facilita l'avviamento a freddo agendo sull'alimentazione.

NOTA

Questa funzione deve essere mantenuta attiva per un tempo limitato ed in ogni caso dipendente dalla temperatura del motore e dell'ambiente esterno. Quando il regime minimo di rotazione è sufficiente a mantenere avviato il motore, è opportuno disattivare il comando.

**Comando Acceleratore**

Questo dispositivo consente di regolare l'alimentazione del motore variandone così il regime di rotazione. Per azionare il dispositivo occorre ruotare la manopola dalla posizione di riposo, corrispondente alla condizione di regime minimo del motore.

Nella condizione di avviamento a freddo (Choke attivo), la ripetuta rotazione della manopola nel senso di chiusura del gas permette di riportare la leva di choke in posizione di riposo.

Leva Freno Anteriore

Questo comando permette di azionare attraverso un circuito idraulico l'impianto frenante della ruota anteriore.



3.5. Interruttore accensione e bloccasterzo



ATTENZIONE: Non applicare portachiavi o altri oggetti alla chiave di accensione per non creare ostacoli alla rotazione dello sterzo.



ATTENZIONE: Non tentare di cambiare alcuna funzione dell'interruttore durante la marcia; si potrebbe incorrere nella perdita di controllo del mezzo.

3

Interruttore accensione e bloccasterzo

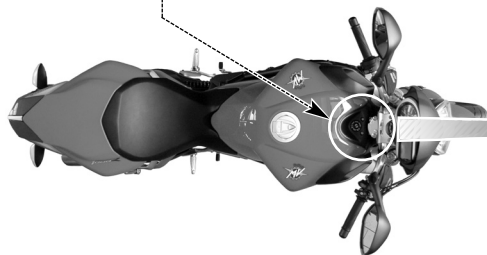

Posizione "ON"

Posizione "OFF"

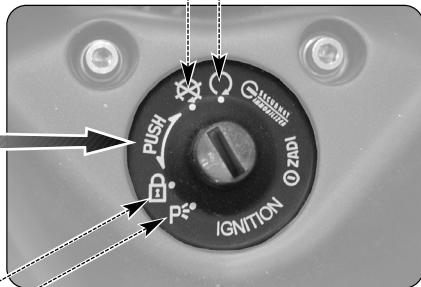

Posizione "LOCK"

Posizione "P"



L'interruttore di accensione attiva e disattiva il circuito elettrico ed il bloccasterzo; le quattro posizioni di comando sono di seguito descritte.

Posizione "OFF"

Tutti i circuiti elettrici sono disattivati. La chiave può essere estratta.



Posizione "ON"

Tutti i circuiti elettrici sono attivati, la strumentazione e le spie eseguono l'autodiagnosi; il motore può essere avviato. La chiave non può essere estratta.



3



Cautela-Precauzione: Non lasciare la chiave sulla posizione "ON" a motore spento per lungo tempo, allo scopo di evitare il danneggiamento dei componenti elettrici della motocicletta.



Posizione "LOCK"

Ruotare il manubrio a sinistra. Premere leggermente la chiave e contemporaneamente ruotarla in posizione "LOCK".

Tutti i circuiti elettrici sono disattivati e lo sterzo è bloccato. La chiave può essere estratta.

3

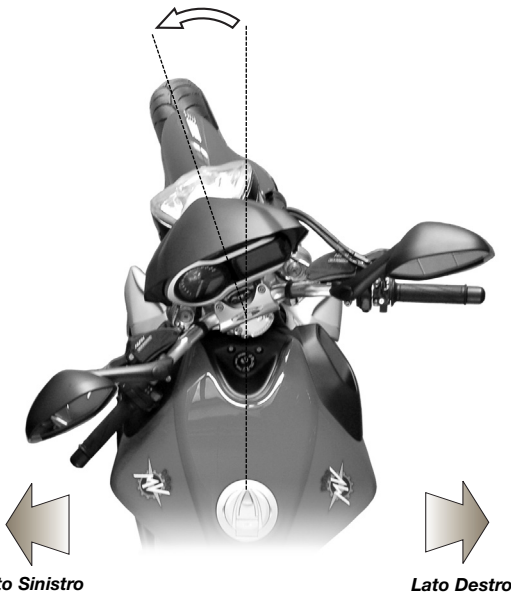



Posizione "P"

Ruotare la chiave dalla posizione "LOCK" alla posizione "P".

Tutti i circuiti elettrici sono disattivati tranne le luci di parcheggio (luci di posizione).

Lo sterzo è bloccato e la chiave può essere estratta.



CAUTELA

Non lasciare la chiave sulla posizione "P" per lungo tempo, allo scopo di evitare di scaricare la batteria della motocicletta.





3.6. Comando cambio

La posizione **N** "Neutral" corrisponde alla posizione di folle segnalata dalla relativa spia cruscotto.

Spostando la leva del cambio verso il basso si innesta la prima marcia.

Analogamente, spostando la leva verso l'alto si innesta la seconda marcia; continuando più volte a spostare la leva verso l'alto si innestano, in modo sequenziale, tutte le altre marce fino alla sesta.

3



Leva comando cambio

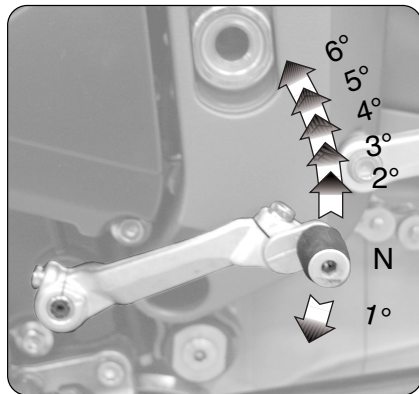



3.7. Strumentazione e spie

Gli strumenti e le spie si attivano ruotando la chiave di accensione in posizione "ON". Dopo un check-up iniziale (~ 7 secondi) le informazioni corrispondono alle condizioni generali della motocicletta in quel momento.

Spie luminose di indicazione (§3.7.1.)

Contagiri

Display cambio e temperatura acqua (§3.7.2.)

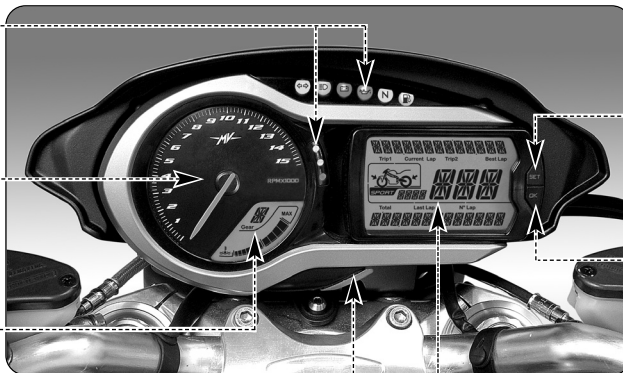

Pulsante "SET" (§3.7.2.)

Pulsante "OK" (§3.7.2.)

Pulsante "HAZARD" (§3.7.2.)

Display multifunzione (§3.7.2.)



3.7.1. Spie luminose di indicazione

Spia luce abbagliante (blu)

Si accende quando è attivata la luce abbagliante.

Spia pressione olio motore (rosso)

Si accende quando l'olio è ad una pressione insufficiente.

Spia indicatori di direzione (verde)

Si accende quando sono attivati gli indicatori di direzione.



Pericolo - Attenzione: Se si accende durante la marcia, fermarsi immediatamente, controllare il livello dell'olio e se necessario farne effettuare il rabbocco presso un centro assistenza autorizzato MV Agusta (vedi §3.8). Se la spia si accende nonostante il livello sia corretto, non proseguire la marcia e contattare un centro assistenza autorizzato MV Agusta.

Spia limitatore giri (rosso)

Si accende quando il motore supera 11600 rpm.

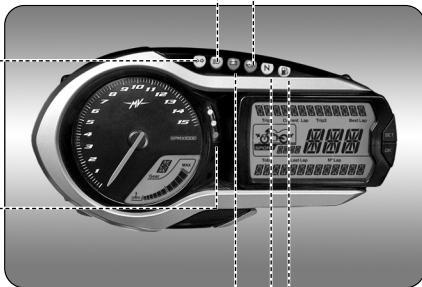

Spia carica batteria (rosso)

Si accende quando l'alternatore non fornisce la corrente elettrica sufficiente a caricare la batteria. Se l'accensione avviene durante la marcia, rivolgersi ad un centro assistenza autorizzato.

Spia riserva carburante (arancio)

Si accende quando nel serbatoio sono contenuti circa 4 litri di carburante.

Spia cambio in folle (verde)

Si accende quando il cambio è nella posizione folle "Neutral".



3.7.2. Display multifunzione / Display cambio e temperatura acqua

Display rapporto cambio

Indica il rapporto del cambio attualmente inserito. La posizione di folle è indicata con la lettera "N" (neutral).

Termometro

Indica la temperatura del liquido di raffreddamento tramite l'accensione di un numero variabile di segmenti su una scala di misura graduata. Quando la temperatura si trova al di fuori del campo di funzionamento normale, possono apparire le seguenti indicazioni:

- sul display compare un unico segmento lampeggiante; è il segnale di temperatura bassa;
- tutti i segmenti sono accesi mentre il segmento superiore lampeggia; è il segnale di temperatura alta.



Pericolo - Attenzione: in caso di temperatura alta, arrestare la motocicletta e controllare il livello del liquido di raffreddamento. Nel caso in cui fosse necessario rabboccarlo, rivolgersi presso un centro assistenza autorizzato MV Agusta (vedi § 3.8). Se l'indicazione compare nonostante il livello sia corretto, non proseguire la marcia e contattare un centro assistenza autorizzato MV Agusta.

Modalità "SPORT"

Indica la modalità sportiva della centralina iniezione.

Tachimetro

Indica la velocità. Il valore può apparire in chilometri orari (Km/h) oppure in miglia orarie (Mph). Il valore a fondo scala è di 320 Km/h (199 Mph).

Pulsante "SET"

Se premuto, consente di selezionare le cifre del display per effettuare le regolazioni.

Pulsante "OK"

Se premuto, consente di confermare le cifre impostate.

Pulsante "HAZARD"

Se premuto, attiva le luci di emergenza.

Contachilometri totale "TOTAL"

Indica la percorrenza totale; da 0 a 999999 (Km o mi)

Contachilometri parziale 1 "TRIP 1"

Indica la percorrenza parziale; da 0 a 999.9 (Km o mi)

Contachilometri parziale 2 "TRIP 2"

Indica la percorrenza parziale; da 0 a 999.9 (Km o mi)

Cronometro

Indica i tempi misurati con la funzione cronometro

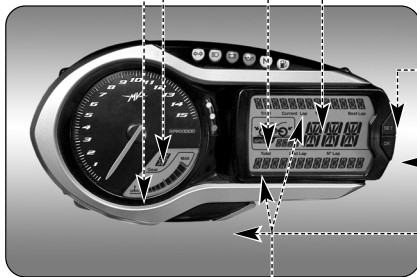



3.8. Tabella lubrificanti e liquidi

Descrizione	Prodotto consigliato	Specifiche
Olio lubrificazione motore	AGIP RACING 4T 10W/60 (*)	SAE 10W/60 - API SJ
Liquido di raffreddamento	AGIP ECO - PERMANENT	Glicole - Etilenico diluito con 50% di acqua distillata
Fluido comando frizione e freni	AGIP BRAKE FLUID DOT4	DOT4
Olio lubrificazione catena	MOTUL CHAIN LUBE ROAD	-

* : Per la reperibilità del prodotto consigliato, MV Agusta consiglia di rivolgersi direttamente ai propri concessionari autorizzati. L'olio motore AGIP Racing 4T 10W/60 è stato realizzato appositamente per il motore del motociclo Brutale. Qualora il lubrificante descritto non fosse reperibile, MV Agusta consiglia l'utilizzo di olii completamente sintetici con caratteristiche conformi o superiori alle seguenti normative:

- Conforme API SJ
- Conforme ACEA A3
- Conforme JASO MA
- Gradazione SAE 20 W-50 o 10 W-60

NOTA

Le specifiche sopra indicate devono essere riportate, da sole od insieme ad altre, sul contenitore dell'olio lubrificante.





4.1. Uso della motocicletta

In questa sezione vengono esposti gli argomenti principali per il corretto uso della motocicletta.



ATTENZIONE

Il motociclo Brutale 990 R presenta elevate caratteristiche di potenza e prestazioni; per il suo uso è pertanto richiesto un'adeguato livello di conoscenza del mezzo. Al momento del primo utilizzo di questo veicolo è necessario adottare un atteggiamento prudente. Uno stile di guida aggressivo o avventato può esporre al rischio di incidenti, compromettendo la Vostra incolumità e quella di altre persone.



ATTENZIONE

LE LIMITAZIONI RELATIVE ALL'USO CONSENTITO DEL VEICOLO SONO RIPORTATE NELLA SEZIONE "INFORMAZIONI PER LA SICUREZZA".



4.2. Rodaggio



Cautela - Precauzione: l'inosservanza delle indicazioni di seguito riportate può pregiudicare la durata e le prestazioni della motocicletta.

È uso comune considerare il rodaggio come una fase applicata al solo motore. In realtà esso va considerato anche per altre parti importanti della moto, in particolare i pneumatici, i freni, la catena di trasmissione, ecc. Nei primissimi chilometri adottare una guida tranquilla.

4

Da 0 a 500 Km (da 0 a 300 mi) (A)

Durante questa percorrenza variare frequentemente il regime di rotazione del motore. Se possibile, privilegiare percorsi leggermente collinosi, con molte curve ed evitare lunghi tratti rettilinei.

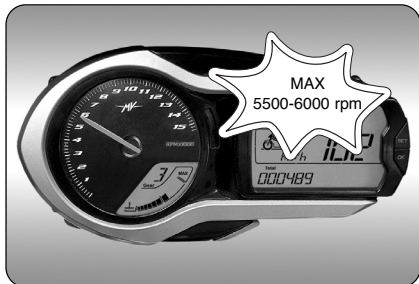

ATTENZIONE

I pneumatici nuovi devono essere sottoposti ad un adeguato rodaggio per raggiungere la completa efficienza. Evitare le accelerazioni, le curve e le frenate brusche per i primi 100 km. Se non si osserva un periodo di rodaggio iniziale dei pneumatici, si rischia di slittare o di perdere il controllo del veicolo con conseguente pericolo di incidenti.



□ **Da 500 a 1000 Km (da 300 a 600 mi)**

Durante questa percorrenza evitare di mantenere a lungo il motore sotto sforzo.

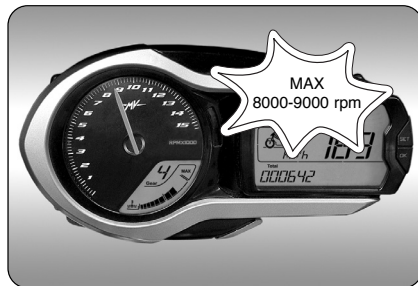

4

□ **Da 1000 a 2500 Km (da 600 a 1600 mi)**

Durante questa percorrenza è possibile pretendere maggiori prestazioni dal motore, senza tuttavia superare il regime di rotazione indicato.

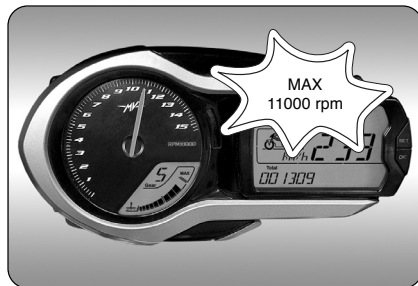



4.3. Avviamento motore



ATTENZIONE

Far funzionare il motore in un ambiente chiuso può essere pericoloso. I gas di scarico contengono monossido di carbonio, un gas incolore ed inodore che può provocare decessi o infortuni gravi. Fare funzionare il motore solo all'esterno, all'aria aperta.



▶ Ruotando l'interruttore d'accensione in posizione "ON", la strumentazione e le spie eseguono l'autodiagnosi; durante questa fase, accertarsi dell'accensione di tutte le spie presenti sul cruscotto.

▶ Affinché il sistema di interruzione del circuito di accensione dia il consenso all'avviamento, deve essere stata soddisfatta una delle seguenti condizioni:

- Il cambio è in posizione di folle con la leva della frizione tirata.
- Il cambio è innestato su una marcia con la leva della frizione tirata ed il cavalletto laterale alzato.



► Nel caso in cui l'autodiagnosi riscontri la presenza di un guasto al veicolo, sul display compare la schermata di errore mostrata nella figura a lato. In particolare viene evidenziato il gruppo o il componente della motocicletta su cui è stato riscontrato il malfunzionamento.



► Premendo il pulsante "OK", il cruscotto passa alla modalità "RUN".

**ATTENZIONE**

In caso di segnalazione di un guasto al veicolo, non avviare il motore e contattare un centro assistenza autorizzato MV Agusta.





❑ Avviamento a freddo

▶ Ruotare la leva "CHOKE" senza ruotare la manopola dell'acceleratore.

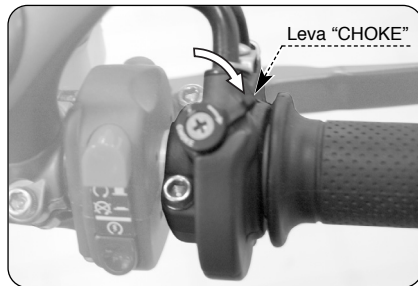

▶ Premere il pulsante di avviamento motore.

▶ Appena il motore si è avviato, rilasciare il pulsante e dopo un breve riscaldamento riportare la leva "CHOKE" nella sua posizione iniziale. ruotare la manopola dell'acceleratore.





❑ Avviamento a caldo

- ▶ Premere il pulsante di avviamento motore senza ruotare la manopola dell'acceleratore.
- ▶ Appena il motore si è avviato rilasciare il pulsante.



Cautela - Precauzione:

- Per evitare danni all'impianto elettrico non azionare l'avviamento per più di 5 secondi consecutivi.
 - Non far funzionare a lungo il motore a motocicletta ferma. Il conseguente surriscaldamento può danneggiare i componenti interni del motore.
- È preferibile portare il motore alla temperatura di esercizio ponendosi in marcia ad andatura ridotta.
- Per allungare al massimo la vita del motore, non accelerare a fondo quando il motore è freddo.





4.4. Selezione e modifica delle funzioni display

La strumentazione prevede la possibilità di intervenire su alcuni dei parametri principali di misurazione.

Le operazioni possibili sono :

- Selezione delle modalità di funzionamento:
 - “RUN” (Contachilometri)
 - “CHRONO” (Cronometro)
 - “SERVICE” (Scadenza manutenzione programmata)
 - “TC” (Controllo di trazione)
 - “IMMOBILIZER” (Sistema antifurto)
- Azzeramento delle funzioni contachilometri parziali:
 - Contachilometri Parziale 1 “TRIP 1”
 - Contachilometri Parziale 2 “TRIP 2”
- Regolazione delle unità di misura relative a:
 - Velocità
 - Distanza percorsa
- Attivazione della funzione cronometro
- Selezione mappatura centralina *



(*): Funzione presente solo su alcuni modelli



4.4.1. Selezione funzioni display

La selezione riguarda le seguenti modalità di funzionamento:

- “RUN” (Contachilometri)
- “CHRONO” (Cronometro)
- “SERVICE” (Scadenza manutenzione programmata)
- “TC” (Controllo trazione)
- “IMMOBILIZER” (Sistema antifurto)

La visualizzazione delle varie modalità di funzionamento avviene premendo il pulsante “SET” per un tempo inferiore a quattro secondi. Agendo su tale pulsante appaiono sul display le funzioni in modo ciclico. Selezionare la funzione desiderata.

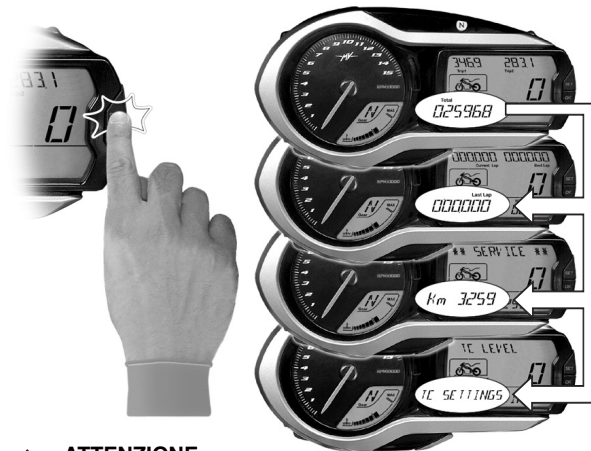

ATTENZIONE

Le operazioni di modifica o regolazione delle funzioni display devono essere eseguite con motore spento, cambio in folle, motocicletta ferma e piedi a terra. È vietato cambiare le impostazioni del display durante la marcia.



□ Modalità “RUN”

Oltre alla funzione tachimetro, sul display vengono visualizzate le seguenti funzioni (vedi §4.4.2.):

- Contachilometri Totale “TOTAL”
- Contachilometri Parziale 1 “TRIP 1”
- Contachilometri Parziale 2 “TRIP 2”

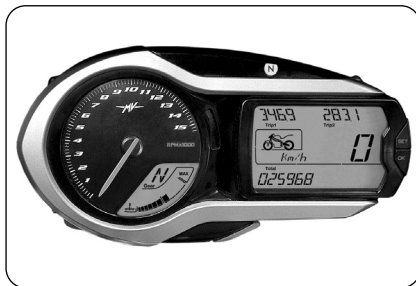

4

□ Modalità “CHRONO”

Questa modalità permette l'attivazione della funzione cronometro e l'immagazzinamento dei dati misurati (vedi §4.4.4.). Le funzioni visualizzate diventano:

- Cronometro Giro attuale “CURRENT LAP”
- Cronometro Giro più veloce “BEST LAP”
- Cronometro Giro precedente “LAST LAP”
- Contagiri Totale giri percorsi “N° LAP”





☐ Modalità “SERVICE”

In questa modalità di funzionamento viene visualizzato l'intervallo chilometrico rispetto alla scadenza del successivo intervento di manutenzione programmata.

NOTA

Quando la distanza chilometrica al tagliando di manutenzione è inferiore a 1000 km, il relativo valore appare automaticamente al termine della schermata di avvio della motocicletta.

☐ Modalità “TC”

La presente funzione permette di adattare il livello del controllo di trazione del motore secondo le proprie esigenze di guida (vedi §4.4.5.).

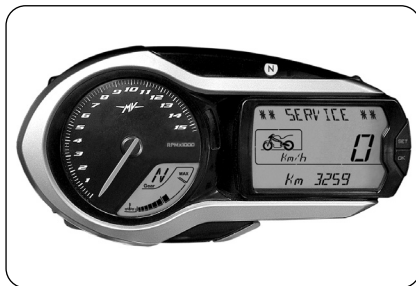

4





□ Modalità “IMMOBILIZER”

La funzione “IMMOBILIZER” consente l’avviamento del motore solamente a seguito del riconoscimento della chiave di avviamento originale. Di fatto essa rappresenta un sistema antifurto integrato nel circuito elettronico del veicolo, dal momento che ne impedisce l’utilizzo a qualunque soggetto non autorizzato.

La modalità “IMMOBILIZER” del cruscotto deve essere utilizzata solamente in caso di malfunzionamento. Infatti, se per un motivo qualsiasi la chiave originale non viene riconosciuta dal sistema, è necessario inserire manualmente il codice segreto riportato sulla MV Code Card allo scopo di ottenere il consenso all’avviamento del motore (vedi §4.4.6.).





4.4.2. Azzeramento delle funzioni contachilometri parziali

I valori delle funzioni “TRIP 1” e “TRIP 2” possono essere azzerati nel modo seguente.



ATTENZIONE

Le operazioni di modifica o regolazione delle funzioni display devono essere eseguite con motore spento, cambio in folle, motocicletta ferma e piedi a terra. È vietato cambiare le impostazioni del display durante la marcia.

► Accedere alla modalità “RUN” e premere il pulsante “SET” per un tempo superiore a quattro secondi fino alla visualizzazione della scritta “RUN MENU”.

► Premere il pulsante “SET” per un tempo inferiore a quattro secondi fino alla visualizzazione della scritta “TRIP 1 RESET”.

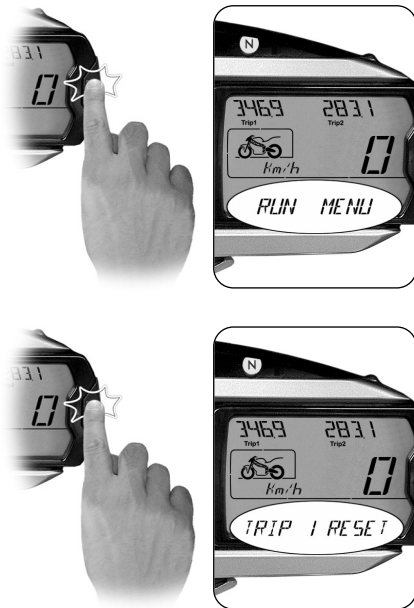



► Premere il pulsante “OK” per un tempo superiore a quattro secondi; il valore “TRIP 1” inizia a lampeggiare.



► Premendo ora il pulsante “OK” per un tempo inferiore a quattro secondi il valore si azzerava. Se invece si preme il pulsante “SET” per un tempo superiore ai quattro secondi la procedura di azzeramento viene interrotta.

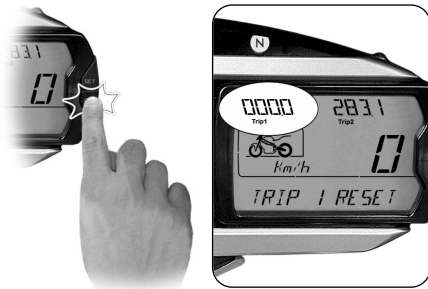



► Premere il pulsante “SET” per un tempo inferiore a quattro secondi fino alla visualizzazione della scritta “TRIP 2 RESET”.

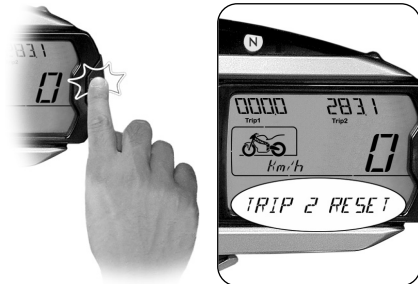

► Premere il pulsante “OK” per un tempo superiore a quattro secondi; il valore “TRIP 2” inizia a lampeggiare.



4



- Premendo ora il pulsante “OK” per un tempo inferiore a quattro secondi il valore si azzerava.
- Se invece si preme il pulsante “SET” per un tempo superiore ai quattro secondi la procedura di azzeramento viene interrotta.

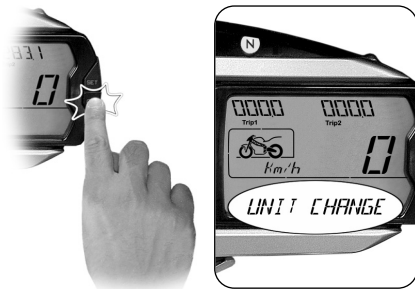
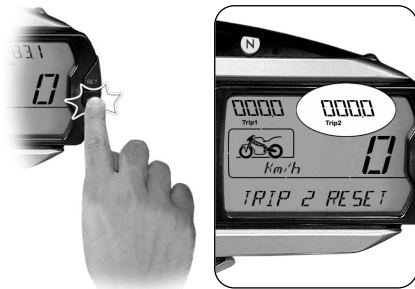

- L'ulteriore pressione del pulsante “OK” consente di uscire dalla modalità “TRIP 2 RESET” per passare alla modalità successiva.



4.4.3. Regolazione delle unità di misura

È possibile eseguire contemporaneamente la modifica delle seguenti unità di misura:

- Velocità
- Distanza percorsa



ATTENZIONE

Le operazioni di modifica o regolazione delle funzioni display devono essere eseguite con motore spento, cambio in folle, motocicletta ferma e piedi a terra. È vietato cambiare le impostazioni del display durante la marcia.

- ▶ Accedere alla modalità "RUN" e premere ripetutamente il pulsante "SET" fino alla visualizzazione della scritta "UNIT CHANGE".
- ▶ Premere il pulsante "OK" per un tempo superiore a quattro secondi; l'unità di misura del tachimetro inizia a lampeggiare.

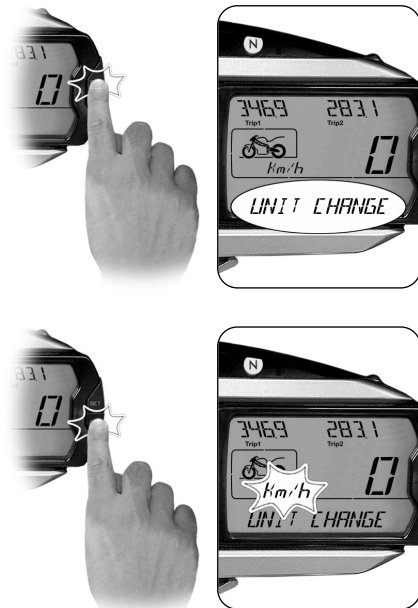



► Premere il pulsante “OK” per passare da Km/h a Mph o viceversa. Variando l’unità di misura del tachimetro, variano automaticamente anche le seguenti grandezze:

- Contachilometri (totale e parziale): Km → mi

Se invece si preme il pulsante “SET” per un tempo superiore ai quattro secondi la procedura di modifica delle unità di misura viene interrotta.

► Premere il pulsante “OK” per un tempo superiore a quattro secondi; la nuova configurazione delle unità di misura viene confermata.

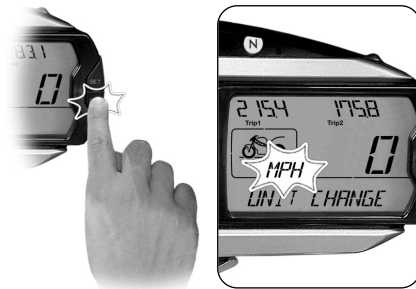



4.4.4. Cronometro

□ Acquisizione dei tempi sul giro

► Dopo aver attivato la funzione cronometro (modalità "CHRONO") è possibile iniziare l'acquisizione dei dati relativi ai tempi di percorrenza sul giro.

► L'azionamento del pulsante del lampeggio faro abbagliante determina l'inizio della misurazione dei dati. I puntini che separano i minuti dai secondi e dai decimi di secondo iniziano a lampeggiare. Lo strumento sta acquisendo i tempi.





► Premendo nuovamente il pulsante del lampeggio fanale abbagliante viene registrata la misurazione del tempo relativo al 1° giro percorso. Contemporaneamente lo strumento inizia ad acquisire il tempo relativo al secondo giro.

La misurazione del tempo relativo al primo giro viene conservata in memoria e rimane visualizzata sul display "LAST LAP" sino all'acquisizione del giro successivo.



► Continuando nell'utilizzo del cronometro, ad ogni azionamento del pulsante di lampeggio viene registrato un tempo. Lo strumento ha la possibilità di eseguire un numero massimo di 100 memorizzazioni consecutive.

Nel caso in cui il tempo del giro appena rilevato fosse inferiore ai tempi misurati durante i giri precedenti, l'indicazione sul display "BEST LAP" viene automaticamente aggiornata con il nuovo valore.





❑ Visualizzazione dei dati

Terminata la fase di acquisizione tempi è possibile eseguirne la visualizzazione.

► Accedere alla modalità “CHRONO” e premere il pulsante “SET” per un tempo superiore ai quattro secondi fino alla visualizzazione della scritta “CHRONO MENU”.



ATTENZIONE

Le operazioni di modifica o regolazione delle funzioni display devono essere eseguite con motore spento, cambio in folle, motocicletta ferma e piedi a terra. È vietato cambiare le impostazioni del display durante la marcia.

► Premere il pulsante “SET” per un tempo inferiore a quattro secondi fino alla visualizzazione della scritta “LAPS VIEW”.

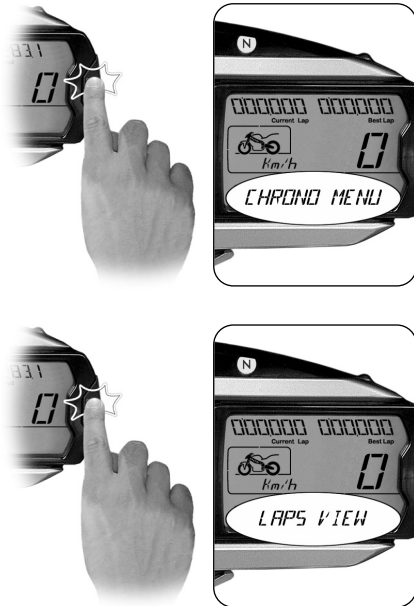



► Premendo il pulsante “OK”, viene visualizzato il tempo sul giro più veloce (“BEST LAP”) ed il numero del giro corrispondente.

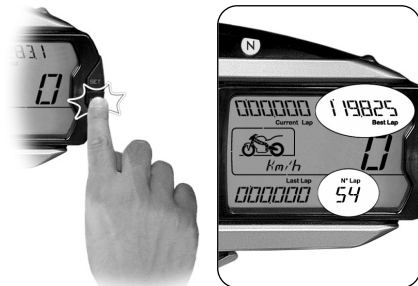

► Successivamente, la ripetuta pressione del pulsante del lampeggio fanale abbagliante consente di visualizzare in sequenza tutti i tempi precedentemente acquisiti a partire dal 1° giro.

► Al termine della visualizzazione dei dati, la pressione del pulsante “SET” consente di uscire dalla modalità “LAPS VIEW” per passare alla modalità successiva.

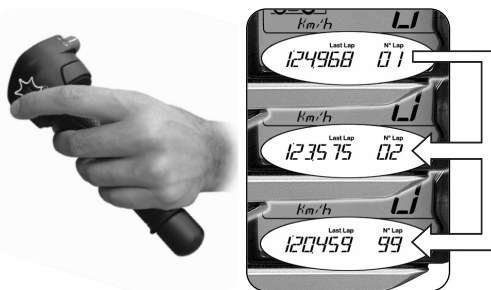



❑ Cancellazione dei dati

L'operazione di cancellazione dei dati memorizzati si esegue applicando la seguente procedura:

► Accedere alla modalità "CHRONO" e premere il pulsante "SET" per un tempo superiore ai quattro secondi fino alla visualizzazione della scritta "CHRONO MENU".



ATTENZIONE

Le operazioni di modifica o regolazione delle funzioni display devono essere eseguite con motore spento, cambio in folle, motocicletta ferma e piedi a terra. È vietato cambiare le impostazioni del display durante la marcia.

► Premere ripetutamente il pulsante "SET" per un tempo inferiore a quattro secondi fino alla visualizzazione della scritta "BEST LAP RESET".

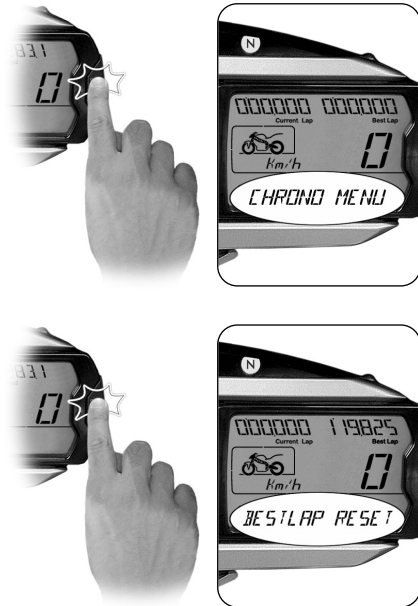



► Premere il pulsante “OK” per un tempo superiore a quattro secondi; il valore “BEST LAP” inizia a lampeggiare.

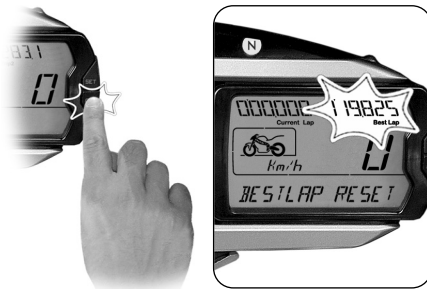

► Premendo ora il pulsante “OK” per un tempo inferiore a quattro secondi il valore viene cancellato. Se invece si preme il pulsante “SET” per un tempo superiore ai quattro secondi la procedura di cancellazione viene interrotta.

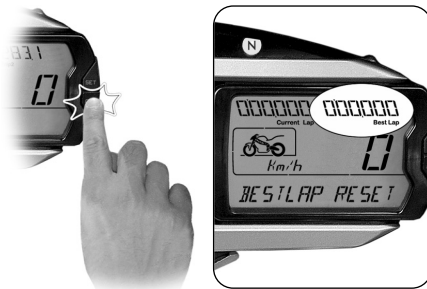



► Premere il pulsante “SET” per un tempo inferiore a quattro secondi fino alla visualizzazione della scritta “LAPS RESET”.

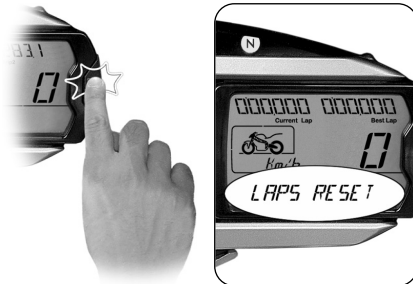

► Premere il pulsante “OK” per un tempo superiore a quattro secondi; il valore “LAST LAP” inizia a lampeggiare.



4



► Premendo ora il pulsante “OK” per un tempo inferiore a quattro secondi, tutti i tempi precedentemente memorizzati vengono cancellati.

Se invece si preme il pulsante “SET” per un tempo superiore ai quattro secondi la procedura di cancellazione viene interrotta.

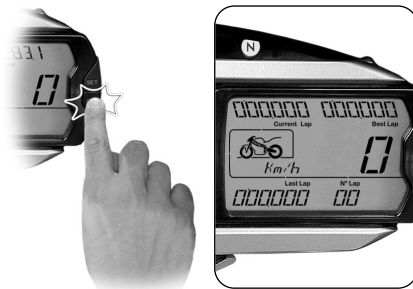
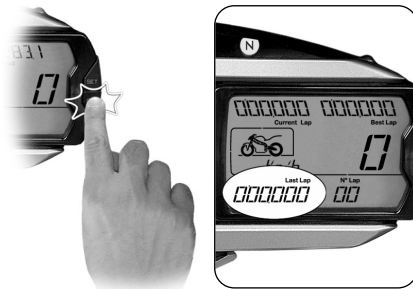

► L'ulteriore pressione del pulsante “OK” consente di uscire dalla modalità “LAPS RESET” per tornare alla funzione cronometro.



4.4.5. Modalità "TC"

► Premere il pulsante "SET" per accedere alla modalità "TC", quindi premere il pulsante "SET" per un tempo superiore ai quattro secondi fino alla visualizzazione della scritta "TC LEVEL". L'attuale livello del controllo di trazione corrisponde al valore visualizzato sul display.



ATTENZIONE

Le operazioni di modifica o regolazione delle funzioni display devono essere eseguite con motore spento, cambio in folle, motocicletta ferma e piedi a terra. È vietato cambiare le impostazioni del display durante la marcia.

► Premendo il pulsante "OK" per un tempo inferiore a quattro secondi, il livello del controllo di trazione viene incrementato passando al valore successivo. Tale valore può variare tra **0** e **8**.

► Premere il pulsante "OK" per un tempo superiore a quattro secondi; il valore prescelto del livello del controllo di trazione viene confermato.

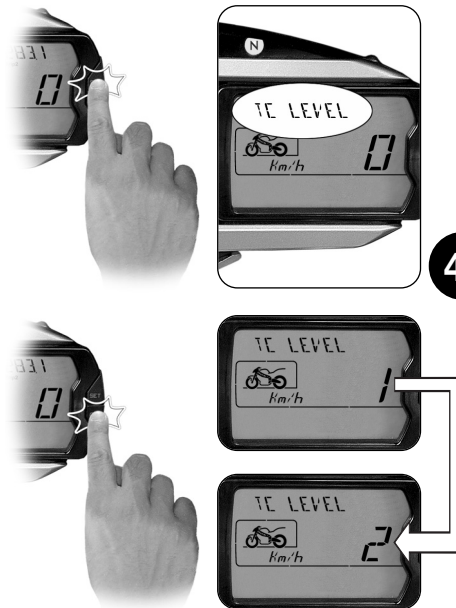



4.4.6. Modalità "IMMOBILIZER"

In caso di malfunzionamento il sistema potrebbe non essere in grado di riconoscere il codice della chiave di avviamento, impedendo così al motore di avviarsi. Per ottenere il consenso all'accensione del motore, è necessario inserire il codice segreto riportato sulla MV Code Card ricevuta al momento della consegna del veicolo.

- 4**
- ▶ Rimuovere la copertura dal riquadro presente sul retro della MV Code Card e leggere il codice elettronico segreto relativo alla chiave di avviamento (nella figura è rappresentato un codice casuale a puro titolo indicativo).
 - ▶ Accedere alla modalità "IMMOBILIZER" e premere il pulsante "SET" per un tempo superiore ai quattro secondi fino alla visualizzazione della scritta "INSERT CODE".



ATTENZIONE

Le operazioni di modifica o regolazione delle funzioni display devono essere eseguite con motore spento, cambio in folle, motocicletta ferma e piedi a terra. È vietato cambiare le impostazioni del display durante la marcia.

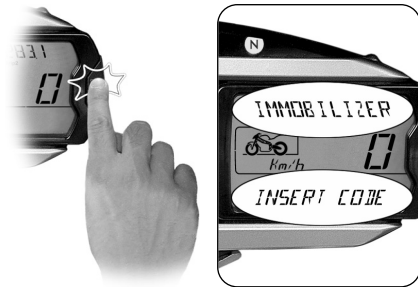



- ▶ Premere il pulsante "SET" per un tempo inferiore a quattro secondi per impostare la prima cifra del codice.
- ▶ La pressione del pulsante "OK" per un tempo inferiore a quattro secondi consente di variare tra **0** e **9** il valore relativo alla prima cifra.

- ▶ Una volta selezionata la cifra prescelta, premere il pulsante "OK" per un tempo superiore a quattro secondi; la prima cifra del codice viene confermata. È ora possibile impostare la seconda cifra del codice.
- ▶ Operando in maniera analoga, è possibile procedere con l'impostazione delle quattro cifre rimanenti.

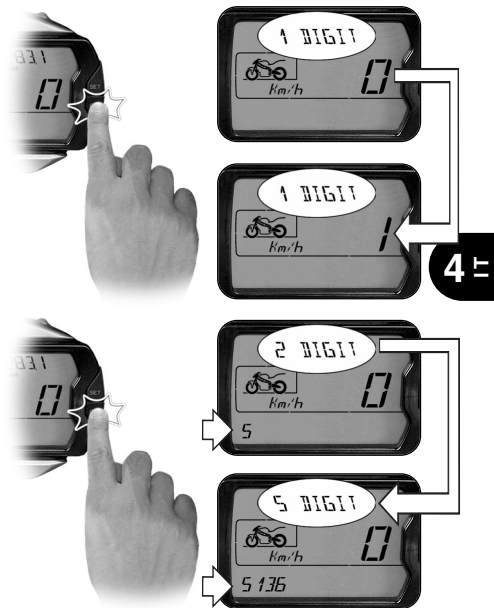



► Una volta completata la procedura di inserimento del codice, sul display compare la scritta “CONFIRM CODE”. Premere il pulsante “OK” per un tempo superiore a quattro secondi per confermare il codice inserito.

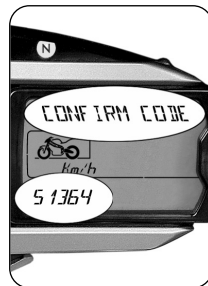

► Se il codice inserito viene correttamente riconosciuto dal sistema, compare la scritta “VALID CODE”. Il display del cruscotto ritorna alla modalità “RUN”. È possibile avviare il motore.

► Se il codice inserito è errato, compare la scritta “NOT VALID CODE”. Il sistema non dà il consenso all'avviamento del motore; il display ritorna alla modalità “INSERT CODE”. Ripetere dall'inizio la procedura di inserimento del codice, facendo attenzione a impostare tutte le cifre corrette riportate sulla MV Code Card in dotazione. Nel caso si riscontrassero ulteriori problemi, contattare un centro assistenza autorizzato MV Agusta.

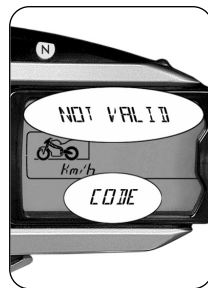
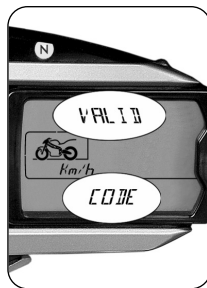



4.4.7. Selezione della mappatura centralina *

Su alcuni modelli Brutale, è possibile selezionare una speciale mappatura della centralina che permette di ottenere caratteristiche elevate di potenza e prestazioni per un uso particolarmente sportivo del veicolo.

La selezione della mappatura centralina può essere effettuata premendo il pulsante di avviamento a motore acceso. L'attivazione della mappatura "SPORT" viene segnalata tramite l'apparizione della relativa dicitura sul display del cruscotto.



ATTENZIONE

Le operazioni di selezione della mappatura centralina devono essere eseguite con motore acceso, cambio in folle, motocicletta ferma e piedi a terra. È vietato cambiare le impostazioni del display durante la marcia.

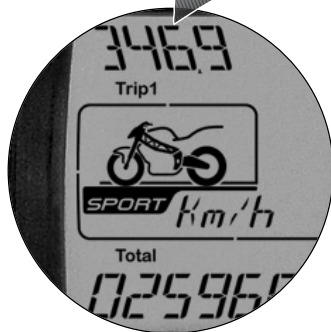

4

(*): Funzione presente solo su alcuni modelli



4.4.8. Messaggi di errore / malfunzionamento

Il cruscotto può segnalare la presenza di un guasto o di un malfunzionamento durante le diverse condizioni di utilizzo della motocicletta.

► *Avviamento motore*: Ruotando l'interruttore d'accensione in posizione "ON", la strumentazione e le spie eseguono l'autodiagnosi. In presenza di un guasto al veicolo, il display visualizza il messaggio di errore mostrato nella figura a lato; in particolare, viene evidenziato il gruppo o il componente della motocicletta su cui è stato riscontrato il malfunzionamento.

► Premendo il pulsante "OK", il cruscotto passa alla modalità "RUN".



ATTENZIONE

Nel caso in cui l'autodiagnosi evidenzi la presenza di un guasto a veicolo fermo, non avviare il motore e contattare un centro assistenza autorizzato MV Agusta.





► *Marcia del veicolo:* Quando viene rilevato un guasto sul veicolo durante la marcia, nella parte inferiore del display viene visualizzato il messaggio di errore mostrato a lato.

**ATTENZIONE**

Nel caso in cui venga segnalata la presenza di un guasto durante l'utilizzo del veicolo, non proseguire la marcia e contattare un centro assistenza autorizzato MV Agusta.

► Al momento dell'arresto del veicolo, sul display viene visualizzato il messaggio di errore che evidenzia il gruppo o il componente della motocicletta su cui è stato riscontrato il malfunzionamento.



4





► *Alta temperatura del liquido di raffreddamento:* Se il sistema rileva un valore eccessivamente elevato della temperatura del liquido di raffreddamento, sul display viene visualizzato il messaggio di errore mostrato a lato. La schermata in questione può comparire durante qualsiasi condizione di utilizzo del veicolo.



ATTENZIONE: In caso di temperatura alta, arrestare la motocicletta e controllare il livello del liquido di raffreddamento. Nel caso in cui fosse necessario rabboccarlo, rivolgersi presso un centro assistenza autorizzato MV Agusta (vedi § 3.8). Se l'indicazione compare nonostante il livello sia corretto, non proseguire la marcia e contattare un centro assistenza autorizzato MV Agusta.





4.5. Rifornimento carburante



Pericolo - Attenzione: la benzina e i suoi vapori sono estremamente infiammabili e nocivi. Evitare il contatto e l'inalazione.

Durante il rifornimento spegnere il motore, non fumare, tenere lontane fiamme, scintille e fonti di calore. Effettuate il rifornimento all'aperto o in locale ben ventilato.



Cautela - Precauzione: utilizzare esclusivamente benzina super senza piombo con un numero di ottano (R.O.N.) di 95 o più. Tale necessità è ricordata da un punto verde sul lato inferiore del tappo serbatoio.

- ▶ Sollevare il coperchio parapolvere.
- ▶ Inserire la chiave e ruotarla in senso orario.

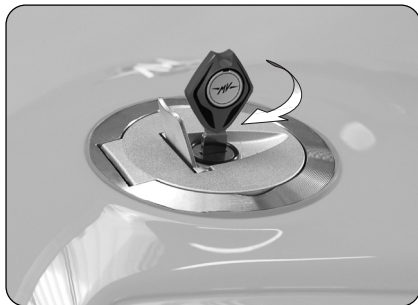
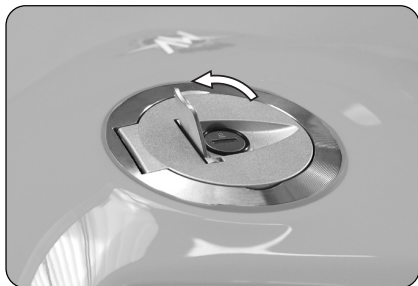

4



- ▶ Sollevare il tappo ed eseguire il rifornimento di carburante.



ATTENZIONE: Un riempimento eccessivo del serbatoio può far traboccare il carburante a causa dell'espansione dovuta al calore del motore o all'esposizione della motocicletta alla luce solare. Eventuali fuoriuscite di carburante possono provocare incendi. Il livello del carburante nel serbatoio non deve mai superare la base del bocchettone di riempimento.

- ▶ Dopo il rifornimento premere il tappo verso il basso ruotando contemporaneamente la chiave in senso orario per facilitare la chiusura. Quindi rilasciare la chiave ed estrarla.



Cautela-Precauzione: Asciugare subito con un panno pulito l'eventuale carburante versato, in quanto può deteriorare le superfici verniciate o di plastica.



ATTENZIONE: Verificare che il tappo del serbatoio del carburante sia chiuso correttamente prima di utilizzare il motociclo.

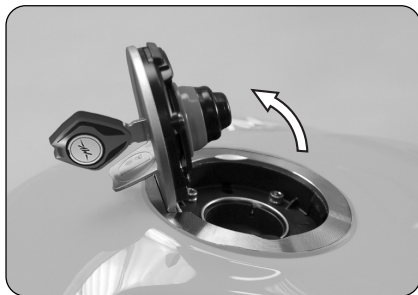



4.6. Accesso al vano portaoggetti

- ▶ Inserire la chiave nella serratura.
- ▶ Ruotare la chiave in senso orario e contemporaneamente premere leggermente sulla sella pilota. Sollevare ed estrarre la sella.

Per il rimontaggio del particolare osservare le seguenti indicazioni :

- Ruotare la chiave nella serratura
- Premere la sella pilota
- Rilasciare la chiave
- Premere nuovamente la sella assicurandosi di averla saldamente agganciata alla struttura.

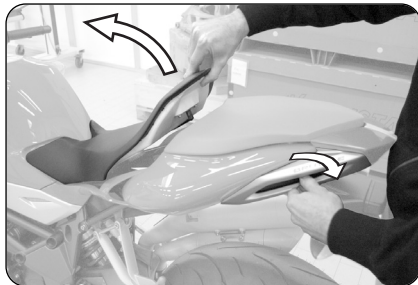

ATTENZIONE

Dopo aver rimosso o sollevato la sella pilota, e comunque prima di ogni utilizzo della moto, assicurarsi che il componente sia stato posizionato correttamente e che risulti ben ancorato alla struttura portante del veicolo.



4.7. Sosta della motocicletta

❑ Sosta con cavalletto laterale



ATTENZIONE

Parcheggiare la motocicletta in condizioni di sicurezza e su terreno stabile. Per la sosta in pendenza parcheggiare con la ruota anteriore a monte e con la prima marcia inserita; ricordarsi di riportare il cambio in folle prima di riavviare la moto. Non lasciare il veicolo incustodito con la chiave di accensione inserita nel quadro.

- ▶ Abbassare il cavalletto col piede fino alla battuta ed inclinare lentamente la motocicletta per porre il piedino di appoggio in contatto col suolo.

Quando il veicolo è in sosta sul cavalletto laterale, è pericoloso sedere a bordo gravando perciò col proprio peso sull'unico appoggio di stazionamento. Prima di mettersi in marcia verificare il funzionamento dell'interruttore di sicurezza accertandosi che la spia di apertura cavalletto laterale sul cruscotto si spenga; in ogni caso verificare che il cavalletto sia rientrato. Se si nota una disfunzione, fare controllare l'impianto da un concessionario MV Agusta prima di utilizzare il mezzo.





□ Sosta con cavalletto posteriore

Inserire il perno del cavalletto nel foro dell'asse ruota posteriore dal lato sinistro della motocicletta; appoggiare il cavalletto al suolo e facendo forza su di esso sollevare il veicolo fino al raggiungimento della condizione di stabilità.



ATTENZIONE

Questa operazione deve essere eseguita da due persone.

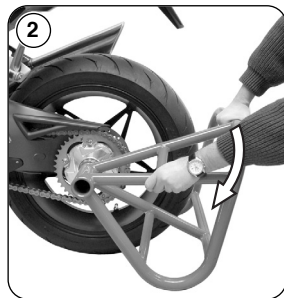
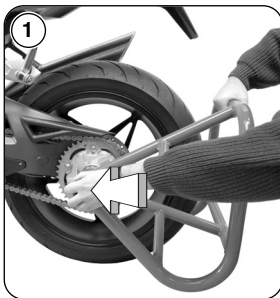



5.1. Elenco regolazioni

La motocicletta possiede un'ampia possibilità di regolazioni che possono migliorare l'ergonomia, l'assetto e la sicurezza.

Tuttavia, poiché una errata regolazione di componenti particolarmente importanti può creare una situazione di pericolo, alcune di queste regolazioni sono riservate soltanto ai Centri Assistenza MV Agusta.



ATTENZIONE

Tutte le regolazioni devono essere effettuate a veicolo fermo.



(E) Regolazione specchietto retrovisore (§5.5.)

(F) Regolazione sospensione anteriore (§5.6)

(A) Regolazione leva
freno anteriore (§5.3.)

(L) Orientamento faro (§5.8.)

(G) Regolazione
sospensione posteriore (§5.7.)

(D) Regolazione leva
freno posteriore (§5.2.)

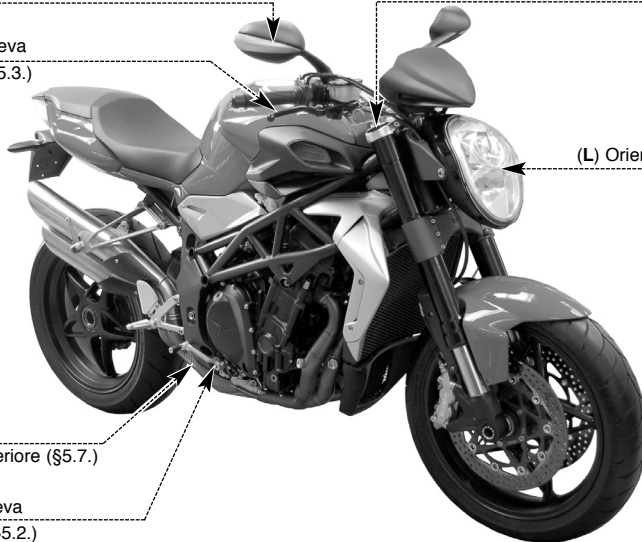



(E) Regolazione specchietto retrovisore (§5.5.)

(F) Regolazione sospensione anteriore (§5.6)

(B) Regolazione leva
frizione (§5.4.)

(C) Regolazione
leva cambio (§5.2.)

(H) Regolazione catena (§5.2.)

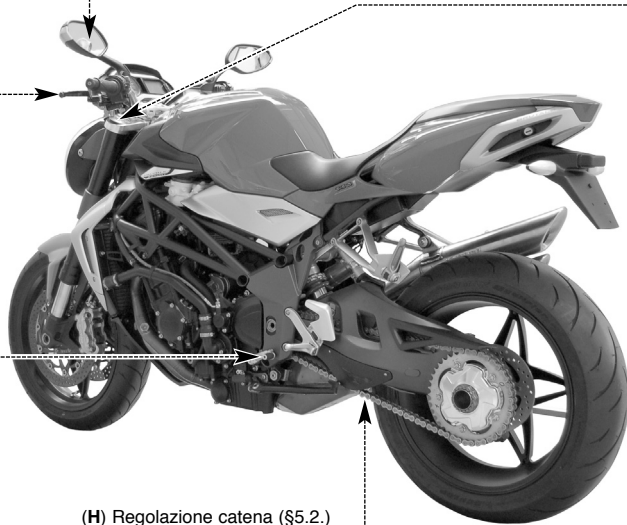



5.2. Tabella delle regolazioni

	A - Regolazione leva freno anteriore: per ottimizzare la presa in funzione delle esigenze del motociclista (§5.3).	
	B - Regolazione leva frizione: per ottimizzare la presa in funzione delle esigenze del motociclista (§5.4).	
	C - Regolazione leva cambio: per ottimizzare il movimento del comando in funzione delle esigenze del motociclista.	
	D - Regolazione leva freno posteriore: per ottimizzare il movimento del comando in funzione delle esigenze del motociclista.	
	E - Regolazione specchietti retrovisori: per ottimizzare l'orientamento (§5.5). ATTENZIONE: Non intervenire sulla vite di fissaggio dello specchietto retrovisore al manubrio. In caso di necessità, rivolgersi ad un concessionario MV Agusta.	
		F - Regolazione sospensione anteriore: per adattare la risposta alle preferenze del motociclista si possono regolare: <ul style="list-style-type: none">- precarico molla (§5.6.1.)- dispositivo idraulico di frenatura in estensione (§5.6.2.)- dispositivo idraulico di frenatura in compressione (§5.6.3.)
		G - Regolazione sospensione posteriore: per adattare la risposta alle preferenze del motociclista si possono regolare: <ul style="list-style-type: none">- precarico molla- altezza assetto- dispositivo idraulico di frenatura in estensione (§5.7.1.)
		H - Regolazione catena: per l'efficienza e la sicurezza della trasmissione.
		L - Orientamento faretto: per regolare la profondità del fascio luminoso in funzione dell'assetto (§5.8).



5.3. Regolazione leva freno anteriore

Tirare la leva per neutralizzare la spinta della molla e, contemporaneamente, regolarne la posizione ruotando la ghiera in senso orario o antiorario. In senso orario: la leva si allontana dalla manopola. In senso antiorario: la leva si avvicina alla manopola.

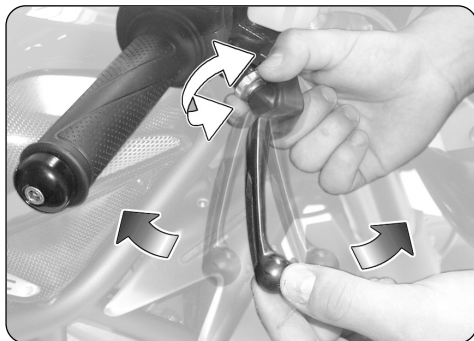

5.4. Regolazione leva frizione

Tirare la leva per neutralizzare la spinta della molla e, contemporaneamente, regolarne la posizione ruotando la ghiera in senso orario o antiorario. In senso orario: la leva si allontana dalla manopola. In senso antiorario: la leva si avvicina alla manopola.

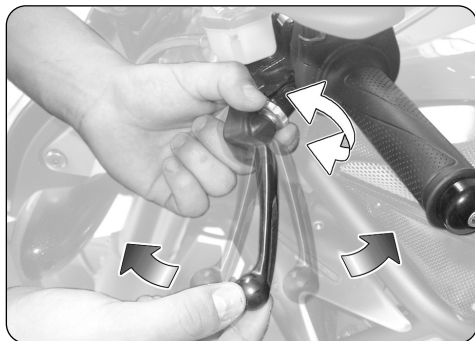



5.5. Regolazione specchietti retrovisori

Premere delicatamente nei punti evidenziati per regolare la posizione nelle quattro direzioni.

Eseguire la regolazione su entrambi gli specchietti retrovisori. Per rendere ottimale la messa a punto si consiglia di eseguire la regolazione salendo sul veicolo.



5



5.6. Regolazione sospensione anteriore

NOTA

La regolazione delle sospensioni deve essere preferibilmente effettuata con il serbatoio carburante pieno.



Dispositivo idraulico di frenatura in estensione

Prearico molla

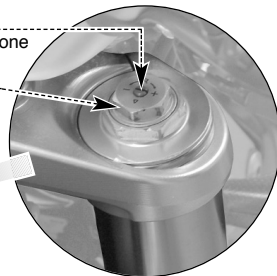

Dispositivo idraulico di frenatura in compressione

Prearico molla

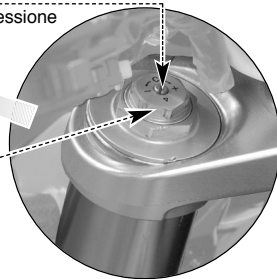



5.6.1. Precarico molla

La regolazione deve essere effettuata partendo dalla posizione standard. Per trovare tale posizione, occorre ruotare in senso antiorario fino a fondo corsa, quindi in senso orario fino alla posizione standard (vedi tabella allegata). Ruotare in senso orario per aumentare il precarico molla, oppure ruotare in senso antiorario per diminuirlo.



5.6.2. Dispositivo idraulico di frenatura in estensione (sospensione anteriore)

La regolazione deve essere effettuata partendo dalla posizione standard. Per trovare tale posizione, occorre ruotare in senso orario fino a fondo corsa, quindi in senso antiorario fino alla posizione standard (vedi tabella allegata). Ruotare in senso orario per aumentare l'azione frenante, oppure ruotare in senso antiorario per diminuirla.





5.6.3. Dispositivo idraulico di frenatura in compressione (sospensione anteriore)

La regolazione deve essere effettuata partendo dalla posizione standard. Per trovare tale posizione, occorre ruotare in senso orario fino a fondo corsa, quindi in senso antiorario fino alla posizione standard (vedi tabella allegata). Ruotare in senso orario per aumentare l'azione frenante, oppure ruotare in senso antiorario per diminuirla.





5.7. Regolazione sospensione posteriore



ATTENZIONE: L'alta temperatura dei tubi di scarico può provocare scottature. Spegner il motore ed attendere che i tubi di scarico si siano raffreddati prima di effettuare la regolazione.

NOTA: La regolazione delle sospensioni deve essere preferibilmente effettuata con il serbatoio carburante pieno.

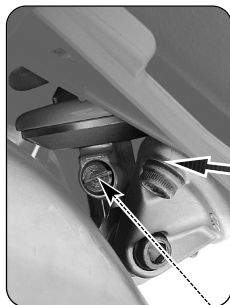

Dispositivo idraulico di frenatura in estensione



5.7.1. Dispositivo idraulico di frenatura in estensione (sospensione posteriore)

La regolazione deve essere effettuata agendo sulla vite presente nella parte inferiore dell'ammortizzatore e partendo dalla posizione standard.

Per trovare tale posizione, occorre ruotare in senso orario fino a fondo corsa, quindi in senso antiorario fino ad avvertire il primo scatto; da questa posizione, occorre ruotare in senso antiorario fino alla posizione standard (vedi tabella allegata).

Ruotare in senso orario per aumentare l'azione frenante, oppure ruotare in senso antiorario per diminuirla.

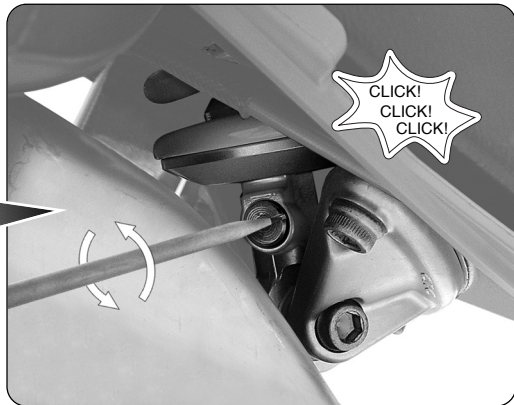



5.8. Regolazione proiettore anteriore

Porre il veicolo a 10 metri di distanza da una parete verticale.

Assicurarsi che il terreno sia piano e che l'asse ottico del proiettore sia perpendicolare alla parete.

Il veicolo deve trovarsi in posizione verticale. Misurare l'altezza del centro del proiettore da terra e riportare sulla parete una crocetta alla medesima altezza.

Accendendo la luce anabbagliante, il limite superiore di demarcazione tra la zona oscura e la zona illuminata deve risultare ad un'altezza non superiore a $9/10$ dell'altezza da terra del centro del proiettore.

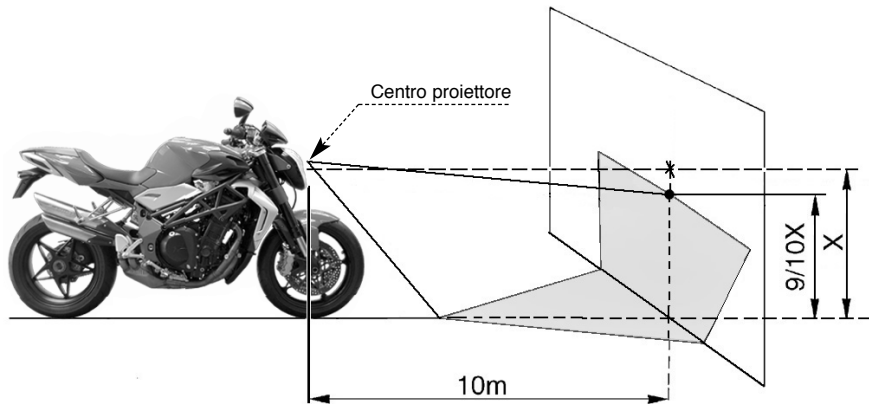



La regolazione del faro anteriore può essere effettuata agendo sulla vite raffigurata a lato. In senso orario: il faro si inclina verso il basso. In senso antiorario: il faro si inclina verso l'alto. L'inclinazione può essere variata di $\pm 4^\circ$ rispetto alla posizione standard.



±5

990R



Nota informativa

MV Agusta S.p.A. è impegnata in una politica di continuo miglioramento dei propri prodotti; per questa ragione potrebbe essere possibile riscontrare leggere differenze tra quanto riportato nel presente documento ed il veicolo da Voi acquistato. I modelli MV Agusta vengono esportati in numerosi Paesi, nei quali valgono norme differenti in relazione al Codice della Strada ed alle procedure di omologazione. Contando sulla Vostra comprensione, MV Agusta S.p.A. ritiene quindi necessario riservarsi il diritto di apportare modifiche ai propri prodotti ed alla propria documentazione tecnica in qualsiasi momento e senza fornirne preavviso.

Vi consigliamo di visitare periodicamente il sito Internet www.mvagusta.it per ottenere informazioni ed aggiornamenti sui prodotti MV Agusta e sulla relativa documentazione.



Rispettiamo e difendiamo l'ambiente

Tutto ciò che facciamo ha ripercussioni sull'intero pianeta e sulle sue risorse.

MV Agusta, a tutela degli interessi della comunità, sensibilizza i Clienti e gli operatori dell'assistenza tecnica ad adottare modalità d'uso del mezzo e di smaltimento di sue parti, nel pieno rispetto delle normative vigenti in termini di inquinamento ambientale, smaltimento e riciclaggio dei rifiuti.

© 2010

È vietata la riproduzione anche parziale di questo documento senza il consenso scritto della MV Agusta S.p.A.

Part. n° 8000B3247

Edizione n° 2 - Luglio 2010



NOTE

5

BRUTALE
990R

MV AGUSTA



User's manual
English Version

Dear Customer,

We wish to thank you for your preference and congratulate you on purchasing your new Brutale 990 R. MV Agusta, thanks to the passionate effort of its technicians, offers to its customers a motorcycle with a new aesthetic design combined with a refined framework: these are the elements which have distinguished every vehicle created by MV Agusta throughout its glorious history.

The result of this effort is an exclusive motorcycle with functional and aesthetic characteristics that place it above the finest motorcycles currently available on the market, making it an exclusive and sought-after item.

In fact, the technologies and solutions applied give to the Brutale 990 R unique characteristics common to all the MV Agusta models, strenghtening a design phylosophy that involves continuous research, technological innovation and love for detail. This way, MV Agusta gives to all the bikers who freely live their passion the chance to possess a unique object, which surely represents a strong reference worldwide.

For further information, please feel free to contact the MV Agusta Customer Care Service.

Have a good time!

*Claudio Castiglioni
MV Agusta
Chairman*



CONTENTS

<i>chap.</i>	<i>Subject covered</i>	<i>page</i>
1	GENERAL INFORMATION	5
1.1.	Purpose of the manual	5
1.2.	Symbols	6
1.3.	Contents of the digital support	7
1.4.	Identification data	8
2	SAFETY INFORMATION	11
2.1.	Allowed use of the vehicle	11
2.2.	Maintenance	11
2.3.	Accessories and modifications	12
2.4.	Vehicle load	12
3	CONTROLS AND INSTRUMENTS	14
3.1.	Location of controls and instruments	14
3.2.	Sidestand	16
3.3.	Handlebar controls, left side	17
3.4.	Handlebar controls, right side	19
3.5.	Ignition switch and steering lock	22
3.6.	Gear lever	26
3.7.	Instruments and warning lights	27
3.7.1.	Warning lights	28
3.7.2.	Multifunction display/Gear and water temperature display	29
3.8.	Table of lubricants and fluids	30

<i>chap.</i>	<i>Subject covered</i>	<i>page</i>
4	OPERATION	31
4.1.	Using the motorcycle	31
4.2.	Running-in	32
4.3.	Starting the engine	34
4.4.	Selecting & setting of the display functions	38
4.4.1.	Selecting the display functions	39
4.4.2.	Trip reset	43
4.4.3.	How to set the measurement units	47
4.4.4.	Chronometer	49
4.4.5.	TC Mode	57
4.4.6.	IMMOBILIZER Mode	58
4.4.7.	How to select the mapping of the control unit	61
4.4.8.	Warning/malfunction alerts	62
4.5.	Refuelling	65
4.6.	Glove compartment	67
4.7.	Parking the motorcycle	68
5	ADJUSTMENTS	70
5.1.	List of adjustments	70
5.2.	Table of adjustments	73
5.3.	Adjusting the front brake lever	74
5.4.	Adjusting the clutch lever	74
5.5.	Adjusting the rearview mirrors	75



CONTENTS

<i>chap.</i>	<i>Subject covered</i>	<i>page</i>
5.6.	Adjusting the front suspension	76
5.6.1.	Spring preload	77
5.6.2.	Rebound damper (front suspension)	77
5.6.3.	Compression damper (front suspension)	78
5.7.	Adjusting the rear suspension	79
5.7.1.	Rebound damper (rear suspension)	80
5.8.	Headlight adjustment	81



1.1. Purpose of the manual

This User's Manual contains the necessary information for a correct and safe use of the motorcycle.

Together with this manual, a pocket Quick Manual is also supplied, in which the minimum essential informations for the use of the vehicle are reported.

The User's Manual is also supplied in electronic format (.pdf) on this digital support and it can be printed or viewed on any PC, equipped either with Windows or Mac operative system.

We recommend to carefully read the User's Manual before using your motorcycle, and to make sure that anyone who uses the motorcycle had previously made the same.

Finally, we recommend to always take with you the Quick Manual, after having filled it in with your personal ID data and the specifications of your motorcycle.



Copyright
MV AGUSTA Motor Spa
All rights reserved



1.2. Symbols

Sections of text that are particularly important in terms of personal safety or possible damage to the motorcycle are marked with the following symbols:



Danger - Failure to observe these prescriptions, even in part, may pose a serious hazard to the driver's and other people's safety.



Caution - Failure to observe these prescriptions, even in part, may result in damage to the motorcycle.

The following symbols give an indication of who is supposed to perform the different adjustments and/or maintenance operations:



Information on operations that can be carried out by the user.



Information on operations that must be carried out only by authorized personnel.

The following symbols are used to provide further information:



The “” symbol points out the requirement to use a tool or a special equipment in order to correctly perform the described operation.



The “§” symbol refers the reader to the chapter identified by the number that follows.



1.3. Contents of digital support

Inside this digital support you will find, besides the User's Manual, the Maintenance Manual, the Quick Manual (which is also supplied in a paper copy), the World Dealer Guide and the Warranty Booklet, the Warranty booklet and the Special parts caatlogues MV Agusta.

When delivering the bike, your Dealer has also supplied the Warranty and Pre-Delivery Certificate.

We recommend to keep it together with the motorcycle documents and with the service coupons that are given at the moment of servicing the bike.

IMPORTANT

The copy of the Warranty and Pre-Delivery Certificate to be sent to MV Agusta must be filled in by the dealer and returned to the factory within 10 days from the date of registration.

The dealer must always fill in the service coupon and return it to MV Agusta within 10 days from the date of the servicing .

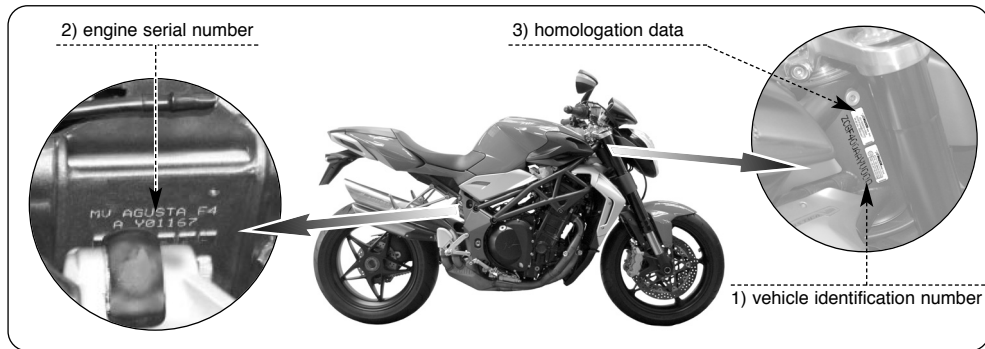

1.4. Identification data

- 1) vehicle identification number
- 2) engine serial number
- 3) homologation data

► **Motorcycle identification**

The motorcycle is identified by the vehicle identification number. When placing orders for spare parts, in addition to this number, you may be required to provide the engine serial number, the colour code and the key identification.

We recommend writing down the main numbers in the spaces provided below.

FRAME No.: _____

ENGINE No.: _____



► Motorcycle key identification

A key is supplied in duplicate for both the ignition and all the locks. Keep the duplicate in a safe place.

It is essential to provide the key identification number if you place an order for a spare motorcycle key. The key identification number is located on the MV Code Card equipped with the ignition keys.

**1 GB**

► Identification of motorcycle colour combination

The colour code must be mentioned when ordering body spares. It can be read on the lower right side of the fuel tank.

In order to get to the colour code label, it is necessary to remove the fuel tank right-hand side fairing. Pull out the rear part of the fuel tank right-hand side fairing as shown in the figure.

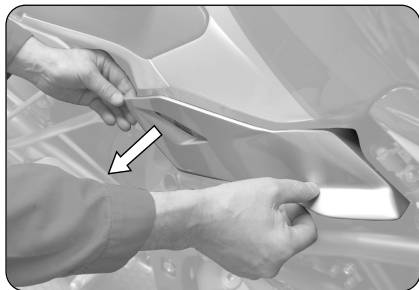



GB
1

Remove the fuel tank right-hand side fairing by pulling it towards the rear part of the motorcycle.

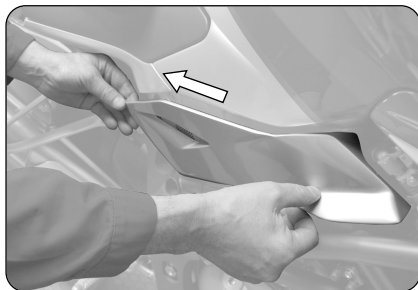

After removing the fuel tank left-hand side fairing, it is possible to get to the colour code label. On this label you can read the motorcycle colour combination, which determines the painting of the bodywork parts.

We recommend writing down the colour code in the space provided below:

COLOUR CODE:

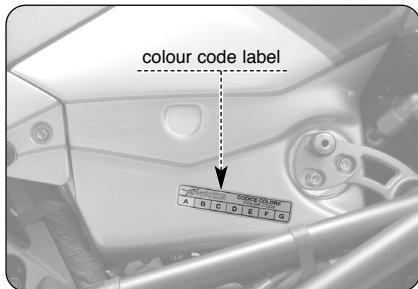



2.1. ALLOWED USE OF THE VEHICLE

Your motorcycle has been strictly designed for use on road or highway route.



WARNING

Occasionally, it is possible to use your motorcycle on race track during non-competitive events.

In this case, however, in consequence of the higher stresses affecting the bike during this specific use, we recommend to have its conditions checked by an authorized MV Agusta Service Center before and after using it.

Any other use of the vehicle is prohibited and explicitly excluded.

You can find further information about the use of the vehicle in the section no. 4 of this Manual.

2.2. MAINTENANCE

In order to guarantee the maximum efficiency and reliability of the vehicle, it is necessary to perform the programmed maintenance operations reported in the Maintenance Manual.

MV Agusta recommends that all maintenance operations are performed only by skilled personnel from an authorized MV Agusta Service Center. Anyway, if you decide to have the maintenance operations performed by non-authorized workshops, you must ensure that they have the skills and the specific tools necessary to perform the above operations.



WARNING

The MV Agusta Warranty could not be valid if non-authorized workshops had performed operations on the bike in a different way from what is described on the Technical Circular Letters and on the related MV Agusta Workshop Manuals.



2.3. ACCESSORIES AND MODIFICATIONS



WARNING

MV Agusta prohibits to make any modification to its motorcycles.

This is necessary to preserve the safety of its Customers.

Anyway, it is possible to customize your motorcycle by consulting the extensive MV Agusta Accessory Catalogue.



WARNING

The installation of some of the above accessories could invalidate the bike homologation, and consequently make the bike not furtherly usable on public roads.

If you have doubts, we suggest to refer to your MV Agusta Dealer in order to choose the accessories which can better suit your needs.

2.4. VEHICLE LOAD

Your motorcycle is designed for use by the rider and it can also seat a passenger.

To use the vehicle in complete safety and in accordance with the Highway Code provisions, it is compulsory that the following maximum load conditions are never exceeded:

BRUTALE 990 R

Maximum total weight	370 kg
Maximum load weight	180 kg

The maximum total weight comes out from the sum of the following weights, according to the European standard CEE 92/61:

- weight of the motorcycle;
- weight of the driver;
- weight of the passenger;
- weight of the load and all the accessories.

**WARNING**

Since the load can strongly affect handling, braking, performance and safety characteristics of your motorcycle, you should always keep in mind the following warnings.

- **NEVER OVERLOAD YOUR MOTORCYCLE!** Driving an overloaded motorcycle can cause damage to the tyres, loss of control of the vehicle and serious injury. Verify that the total weight (including the weight of the motorcycle, the driver, the passenger, the load and all the accessories) does not exceed the maximum value specified for your vehicle.



3.1. Location of controls and instruments

GB 3

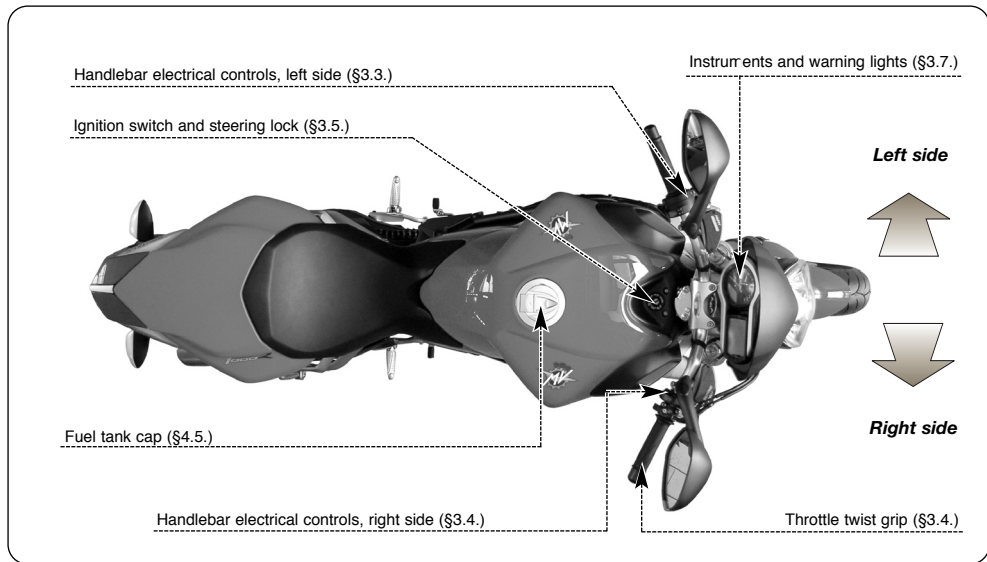

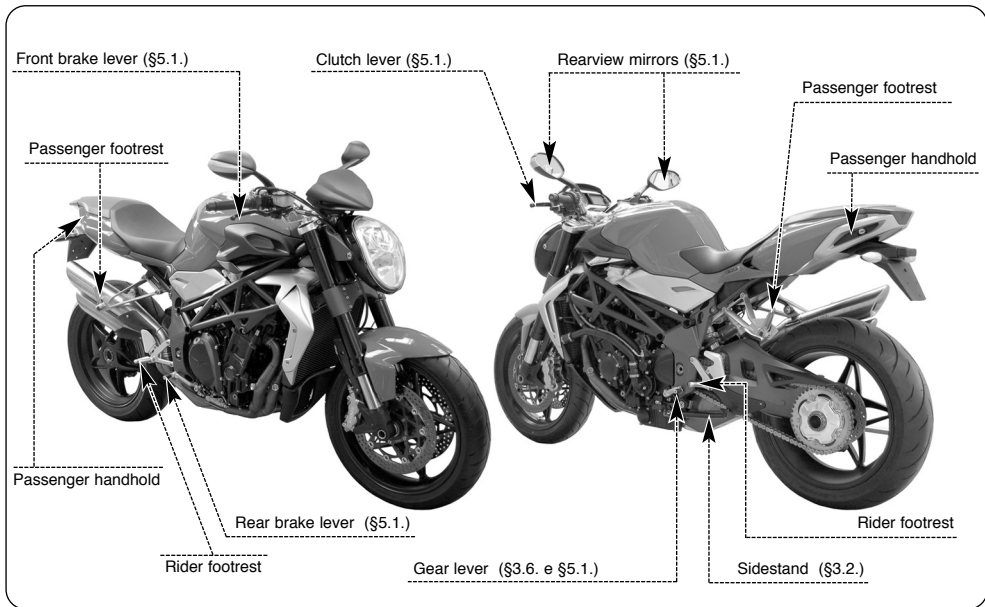



3.2. Sidestand

The sidestand is equipped with a safety switch that prevents the motorcycle from moving off while the stand is down.

If the rider attempts to engage the gears while the engine is running and the stand is down, the switch automatically turns off the engine by cutting the current supply.

If the motorcycle is parked (side-stand down) and the gears are engaged, the switch prevents the engine from being started, thereby avoiding the risk of accidentally toppling the vehicle.

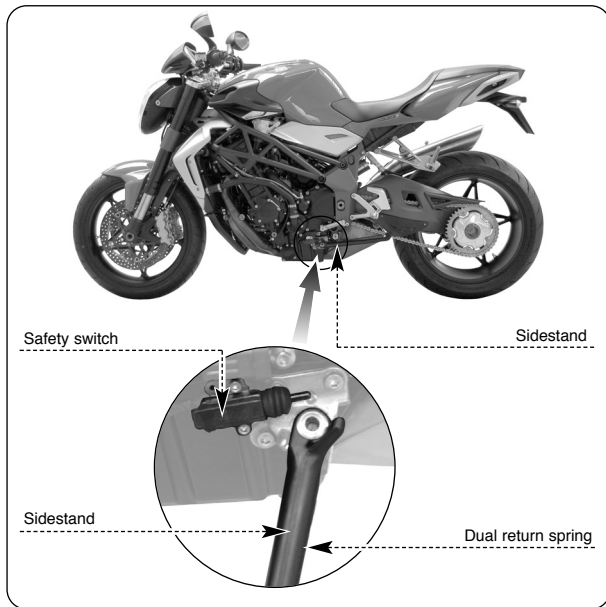



3.3. Handlebar controls, left side

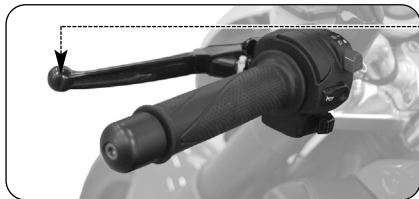

Clutch lever

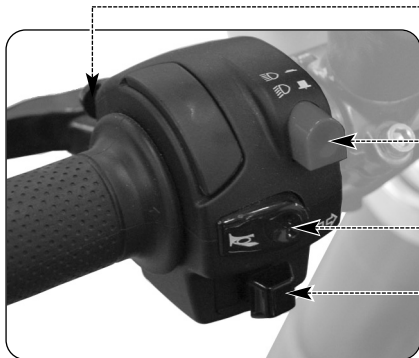

Move towards/away from the handgrip to release/engage the clutch.



High beam flasher button

Press the button repeatedly.

Low/high beam button

Button not pressed in  : low beam 

Button pressed in  : high beam 

Horn button

Press to operate the warning horn.

Turn indicator switch

Shifting the lever to the left or right switches on the left or right turn indicators. The switch then returns to the central position. Press to turn off the indicators.



High beam flasher button

It is used to attract the attention of other road users in case of danger. When the high beam is on, the function is inactive.

Low/high beam button

Under normal conditions, the low beam is on. The high beam can be switched on by pressing the button when allowed by the traffic and road conditions.

Turn indicator switch

It is used to show the rider's intention to change direction or lane.



WARNING

Failure to switch the turn indicators on or off at the right time may cause an accident in that the other road users may draw incorrect conclusions about the direction of motion of the vehicle. Always switch on the indicators before turning or changing lanes. Then be sure to switch off the indicators after completing the operation.

Horn button

It is used to attract the attention of other road users in case of danger.

Clutch lever

It engages/disengages the clutch through a hydraulically controlled device.



3.4. Handlebar controls, right side

Front brake lever

Pull to the lever to apply the front brake.

Throttle twist grip

Rotate counterclockwise to increase engine speed.

Cold start (choke) lever

Rotate clockwise when cold starting. After the engine has run for a few seconds, return the lever to its original position.

Engine stop switch

Stops the engine and prevents it from being restarted.

Engine start button

Starts the engine. To be released as soon as the engine starts. When the engine is running, pressing the button selects the display functions.

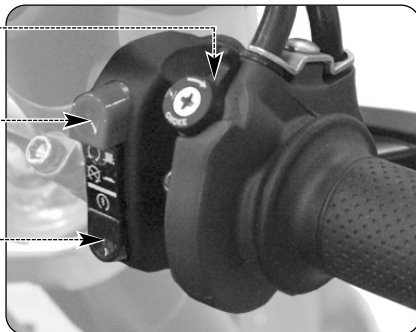
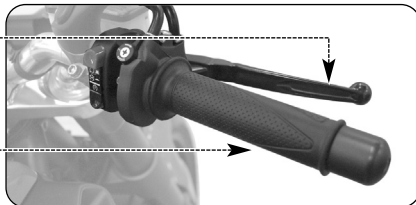

**Engine stop switch**

It is used to switch off the engine in an emergency. The ignition circuit is disabled, preventing the engine from being restarted. To be able to restart the engine, return the switch to its original position.

NOTE

Under normal conditions, do not use this switch to shut off the engine.

Engine start button

It is used to start the engine and, when the engine is running, to select the different functions of the display installed on the instrument panel.

**CAUTION**

To avoid damaging the electrical equipment, be sure not to hold down the button for longer than 5 consecutive seconds.

If, after some attempts, the engine does not start, refer to the chapter “TROUBLESHOOTING” later in this manual.

Cold start (choke) lever

It facilitates cold starting by slightly enriching the fuel-air mixture during start-up.

NOTE

This function must remain active only for a short time depending on the engine and environmental temperature. As soon as the idle speed keeps the engine running, it is advisable to disable the control.



Throttle twist grip

It controls the fuel-air mixture supplied to the engine, which regulates engine speed. To increase engine speed, rotate the hand grip from its idle position counterclockwise.

When cold starting (choke on), rotating the throttle twist grip clockwise fully and repeatedly causes the choke lever to return to its original position.

Front brake lever

It controls a hydraulic circuit that operates the front wheel braking system.



3.5. Ignition switch and steering lock



WARNING

Do not attach a ring or any other object to the ignition key as they may hinder the steering action.



WARNING

Never attempt to change the switch functions while riding, as you may lose control of the vehicle.

GB 3

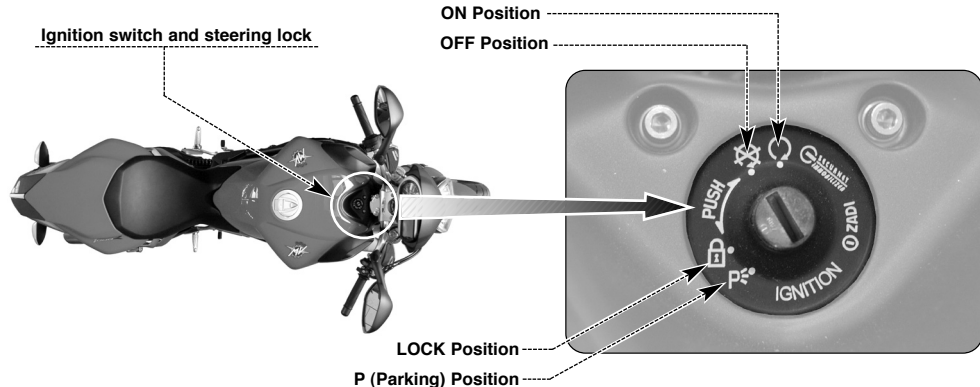



The ignition switch enables and disables the electrical circuit and the steering lock. The four positions of the switch are described below.

OFF position

All electrical circuits are deactivated. The key can be removed.



ON position

All electrical circuits are activated. The instruments and warning lights perform the self-diagnostic cycle. The engine can be started. The key cannot be removed.



3 GB



CAUTION: Do not leave the key on the ON position for a long time when the engine is not running, in order to avoid damage to the electrical parts of the motorcycle.

**LOCK position**

Turn the handlebar to the left. Press the key in gently while rotating it to the LOCK position. All electrical circuits are deactivated and the steering is locked. The key can be removed.

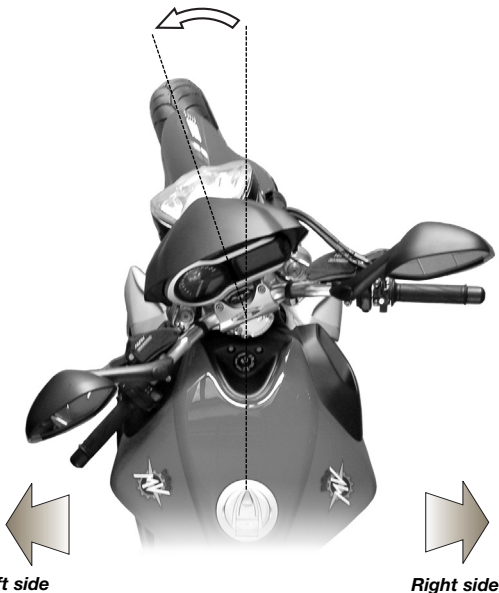
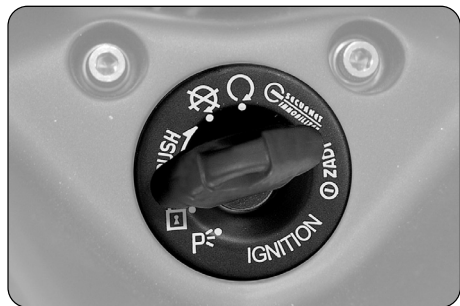



P (PARKING) position

Turn the key from the LOCK position to the P position. All electrical circuits are deactivated except the parking lights. The steering is locked. The key can be removed.



CAUTION

Do not leave the key on the P position for a long time, in order to avoid discharging the battery of your motorcycle.





3.6. Gear lever

The **N** (neutral) position is indicated by the warning light on the instrument panel.

To change into first gear, push the lever down.

To change into second gear, lift the lever up. Lifting the lever up repeatedly engages all the other gears in succession up to the sixth speed.

GB
3



Gear lever

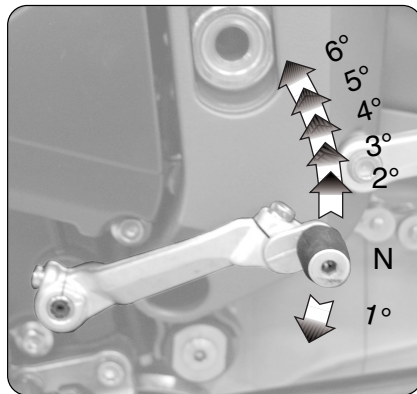



3.7. Instruments and warning lights

The instruments and warning lights are activated by turning the ignition switch to the ON position. After a preliminary check (approx. 7 seconds) the displayed information reflects the current general condition of the motorcycle.

Warning lights
(§3.7.1.)

Tachometer

Gear and water
temperature display
(§3.7.2.)

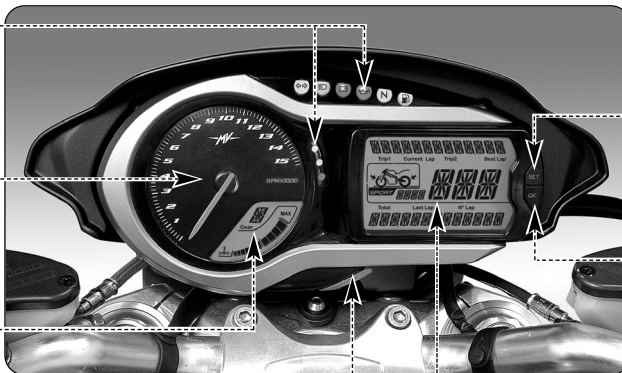

SET button
(§3.7.2.)

"OK" button
(§3.7.2.)

"HAZARD" button (§3.7.2.)

Multifunction display (§3.7.2.)

3 GB



3.7.1. Warning lights

Headlights (blue)

It turns on when the headlights are on.

Engine oil pressure warning lights (red)

Lights up when the oil pressure is insufficient.



WARNING: If the warning light comes on while riding, stop the motorcycle immediately. Check the oil level and if necessary have it restored by a MV Agusta authorized service centre (see §3.8.). If the warning light comes on even if the oil level is correct, do not resume riding and contact a MV Agusta authorized service centre.

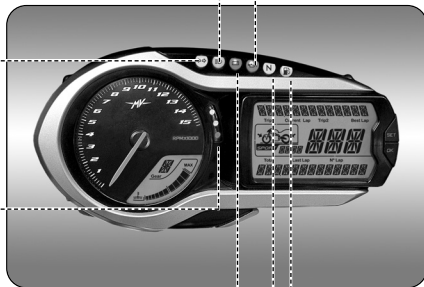

Turn indicator light (green)

Lights up when the turn indicators are activated.

Rev limiter warning light (red)

It turns on when the engine exceeds 11600 rpm.

Battery charge indicator (red)

Lights up when the alternator does not supply enough current to charge the battery. If the indicator comes on while riding, contact an authorized service centre.

Reserve fuel indicator (orange)

Comes on when approximately 4 litres of fuel are left.

Neutral warning lights (green)

It turns on when the gear is in "Neutral".



3.7.2. General display / Gear and Water Temperature Display

Gear display

It displays the currently engaged gear. "N" stands for "neutral".

Thermometer

It displays the temperature of the coolant by turning on a variable number of segments on a graduated scale. When the temperature falls outside the normal operating range, it may display one of the following information:

- the display shows just one blinking segment; it means that the temperature is low;
- all segments are on, while the upper segment is blinking; it means that the temperature is high.



Danger - Notice: if the temperature is high, stop the motorbike and check the coolant level. If it needs to be filled up, contact a MV Agusta licensed service centre (see § 3.8). If the warning light turns on even if the level is adequate, stop driving and contact a MV Agusta licensed service centre.

"SPORT" Mode

It puts the injection unit in Sport Mode.

Speedometer

It displays the speed of the motorbike. It can be given in kilometres per hour (Km/h) or in miles per hour (Mph). The full scale measures 320 Km/h (199 Mph).

"SET" button

Press it to select and set the figures on the display.

"OK" button

Press it to confirm the new settings.

"HAZARD" button

Press it to turn on the emergency lights.

"TOTAL" odometer:

It displays the total distance covered; from 0 to 999999 (Km or miles)

Trip counter 1, "TRIP 1"

It displays the length of a trip; from 0 to 999.9 (Km or miles)

Trip counter 2, "TRIP 2"

It displays the length of a trip; from 0 to 999.9 (Km or miles)

Chronometer

It displays the time measured by the chronometer

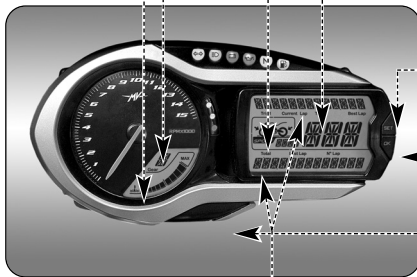



3.8. Table of lubricants and fluids

Description	Recommended product	Specifications
Engine lubrication oil	AGIP RACING 4T 10W/60 (*)	SAE 10W/60 - API SJ
Coolant	AGIP ECO - PERMANENT	Ethylene glycol diluted with 50 percent distilled water
Brake and clutch fluid	AGIP BRAKE FLUID DOT4	DOT4
Drive chain lubrication oil	MOTUL CHAIN LUBE ROAD	—

* : MV Agusta suggests to refer directly to its authorized dealers in order to purchase the recommended product. The AGIP Racing 4T 10W/60 engine oil has been expressly produced for the Brutale motorcycle engine. If the above described lubricant is not available, MV Agusta suggests to use a fully synthetic engine oil having characteristics equal or better than the ones prescribed in the following standards:

- Consistent with: API SJ
- Consistent with: ACEA A3
- Consistent with: JASO MA
- SAE Rating: SAE 20 W-50 or 10 W-60

NOTE

The above standard denominations must be written, alone or together, on the engine oil container label.





4.1. Using the motorcycle

This section provides the basic information needed to correctly operate the motorcycle.

**WARNING**

Your motorcycle Brutale 990 R shows high power and performance characteristics; therefore, its use requires an adequate level of knowledge of the vehicle. When you use this motorcycle for the first time, it is essential to adopt a cautious attitude. An aggressive or reckless riding attitude can lead to accidents, compromising the driver's and other people's safety.

**WARNING**

THE RESTRICTIONS RELATED TO THE ALLOWED USE OF THE VEHICLE ARE DESCRIBED IN THE SECTION "SAFETY INFORMATIONS".



4.2 Running-in



CAUTION

Failure to observe the indications provided below can reduce performance and shorten the life of the motorcycle.

Running-in is generally considered to apply only to the engine. In fact, it should be regarded as an essential phase for other important parts such as the tyres, the brakes and the drive chain. During the very first miles, adopt a relaxed riding style.

□ 0 to 500 km (0 to 300 mi) (A)

Frequently change the engine speed. If possible, prefer hilly routes with gentle slopes and many bends. Avoid long straight stretches.



WARNING

New tyres must undergo a proper running-in period to reach their complete efficiency. Avoid abrupt acceleration, turning and braking during the first 100 km. Failure to observe these prescriptions can lead to the sliding of the wheels and the loss of control of the vehicle with subsequent risk of accidents.



□ **500 to 1000 km (300 to 600 mi)**

Avoid lugging or overspeeding the engine, and vary your speed frequently.

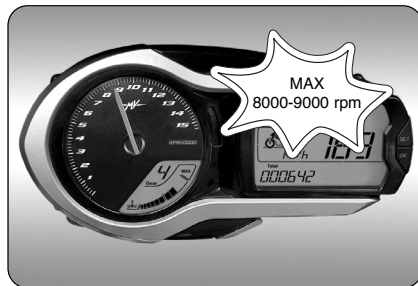

□ **1000 to 2500 km (600 to 1600 mi)**

Higher engine performance can be demanded, but it is advisable not to exceed the engine speed shown in the figure.

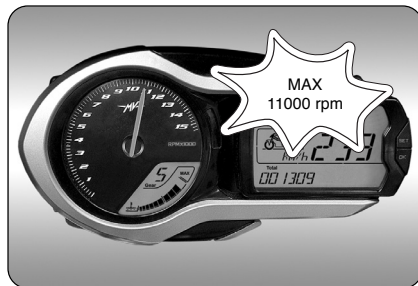



4.3. Starting the engine



WARNING

Starting the engine in a closed place can be dangerous. Exhaust emissions contain carbon monoxide, a colourless and odourless gas that can lead to serious harm or even death when inhaled.

Only start the engine outdoor, in the open air.



► As you turn the ignition switch to the ON position, the instruments and the warning lights will go through the self-diagnostic cycle; during this phase, make sure that all the warning lights on the dashboard come on.

► The start/stop system will let the motorbike turn on if one of the following conditions is met:

- The gear is in neutral with the clutch lever up.
- The gear is engaged with the clutch lever up and the side stand up.



► If the self-diagnostic cycle detects a fault in the vehicle, the display shows the warning alert shown in the picture. In particular, this message highlights the vehicle part or device on which the fault has been detected.



► Press "OK" button to access to "RUN" mode.

**WARNING**

If a fault is detected on the vehicle, do not start engine and contact an authorized MV Agusta centre.





❑ **Cold starting**

▶ Turn the “CHOKE” lever without turning the accelerator handle.

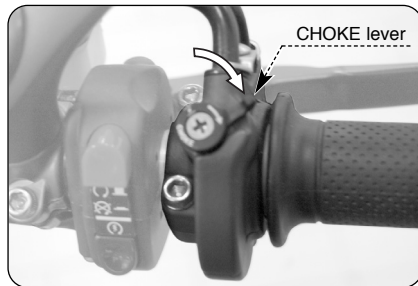

▶ Press the starter button.

▶ As soon as the engine starts, release the button and when just slightly warmed up bring the “CHOKE” lever back to its starting position.

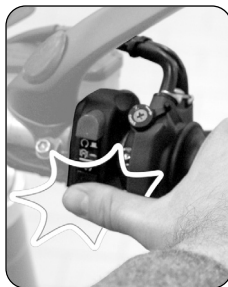



❑ Hot starting

- ▶ Press the start button without turning the throttle twist grip.
- ▶ As soon as the engine starts, release the button.

CAUTION



- Do not press the start button for longer than 5 consecutive seconds, in order to avoid damage to the electrical equipment.
- Avoid warming up the engine while the vehicle is stationary. The subsequent engine overheating can cause damage to the internal parts of the engine. It is advisable to bring the engine to the working temperature by riding at reduced speed.
- To ensure the maximum life of the engine, never speed up at full throttle when the engine is cold





4.4. Selecting and setting the display functions

Some of the main measurements of the instruments may be changed.

The available options include:

- Select an operating mode:
 - “RUN” (Odometer)
 - “CHRONO” (Chronometer)
 - “SERVICE” (Expiration of scheduled maintenance service)
 - “TC” (Traction control)
 - “IMMOBILIZER” (Antitheft device)
- Reset the trip counter:
 - Trip counter 1 “TRIP 1”
 - Trip counter 2 “TRIP 2”
- Set the measurement units for
 - Speed
 - Distance covered
- Turn on the chronometer
- Control unit mapping selection *

(*): This function is present only on certain models





4.4.1. Selecting the display functions

The following settings may be changed on the display:

- “RUN” (Odometer)
- “CHRONO” (Chronometer)
- “SERVICE” (Expiration of scheduled maintenance service)
- “TC” (Traction control)
- “IMMOBILIZER” (Antitheft device)

To display the operating modes, press “SET” for less than four seconds. When pressed, the display shows all modes, in a sequence. Select the desired mode.

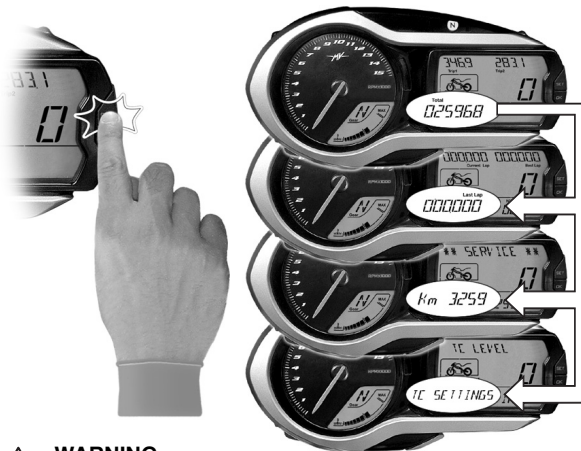

4 GB



WARNING

The operation must be performed while the engine is not running, the gears are in neutral, the motorcycle is stationary, and with the feet on the ground. Do not set the display functions while riding.



□ “RUN” mode

In addition to the speedometer, the display shows the following functions (see §4.4.2.):

- Total odometer “TOTAL”
- Trip counter 1 “TRIP 1”
- Trip counter 2 “TRIP 2”



□ “CHRONO” Mode

This mode turns on the Chronometer and saves the recorded information (see §4.4.4.).

The following is displayed:

- Chronometer Current lap “CURRENT LAP”
- Chronometer Fastest lap “BEST LAP”
- Chronometer Last lap “LAST LAP”
- Rev counter Total laps covered “N° LAP”





❑ “SERVICE” Mode

It shows after how many kilometres the motorbike will have to undergo the next scheduled service.

NOTE

When the next service is less than 1000 km away, such value is automatically displayed at the end of the starter page.

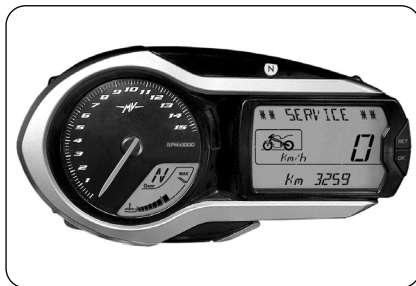

❑ “TC” Mode

This Mode adjusts the engine traction control level to your driving requirements (see §4.4.5.).





□ “IMMOBILIZER” Mode

The “IMMOBILIZER” lets the engine start only if it recognises the original starter key. This is actually an anti-theft device built into the electronic circuit of the vehicle, since only authorised people are allowed to drive it. Use the dashboard “IMMOBILIZER” only in the event of a breakdown. If for any reason the original key is not recognised by the system, you must manually enter the secret code, which is on the MV CodeCard, to let the engine start (see §4.4.6.).





4.4.2. Trip reset

To reset “TRIP 1” and “TRIP 2”, proceed as follows.



WARNING

The display modes may be changed or set when the engine is off, the gear in neutral, the motorbike stationary with your feet on the ground. The display may not be changed while driving.

▶ Access “RUN” and press “SET” for more than four seconds until “RUN MENU” appears.

▶ Press “SET” for less than four seconds until “TRIP 1 RESET” appears.

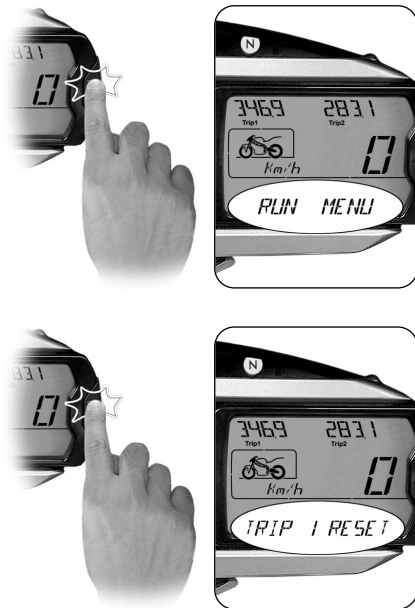



▶ Press “OK” for more than four seconds; “TRIP 1” starts blinking.



▶ Now, press “OK” for less than four seconds, it will clear the display. Otherwise, press “SET” for more than four seconds to stop the reset procedure.

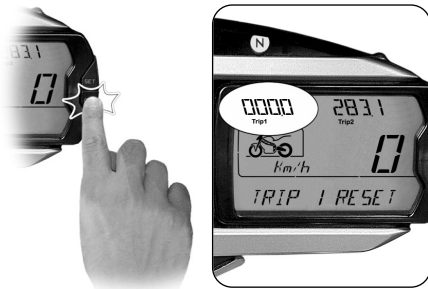

GB 4



▶ Press “SET” for less than four seconds until “TRIP 2 RESET” appears.

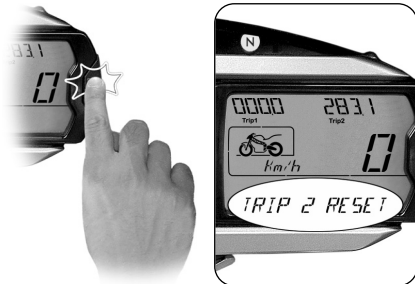

▶ Press “OK” for more than four seconds; “TRIP 2” starts blinking.





► Now, press “OK” for less than four seconds, it will clear the display. Otherwise, press “SET” for more than four seconds to stop the reset procedure.

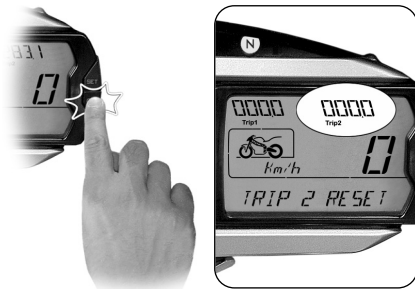

► Press “OK” again to quit “TRIP 2 RESET” and move on to the next mode.

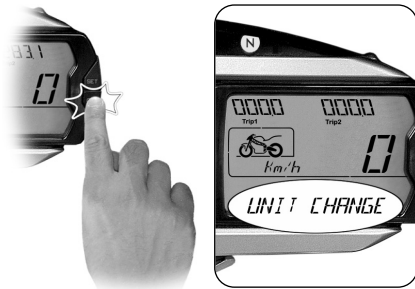

GB 4



4.4.3. How to set the measurement units

The following measurement units may be changed at the same time:

- Speed
- Distance covered



WARNING

The display modes may be changed or set when the engine is off, the gear must be in neutral, the motorbike must be stationary with your feet on the ground. Do not change the display while driving.

- ▶ Access “RUN” and press “SET” repeatedly until “UNIT CHANGE” appears.
- ▶ Press “OK” for over four seconds; the measurement unit of the speedometer starts blinking.

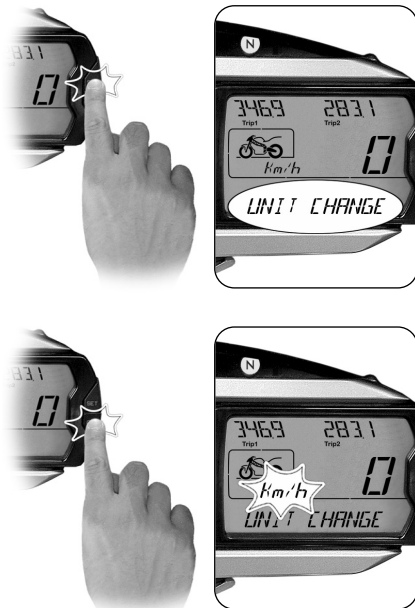



► Press “OK” to change from Km/h to Mph, or vice versa. When you change the measurement unit of the speedometer, the following quantities will change accordingly:

- Odometer (total, trip): Km → mi

Otherwise, press “SET” for over four seconds to stop resetting the measurement units.

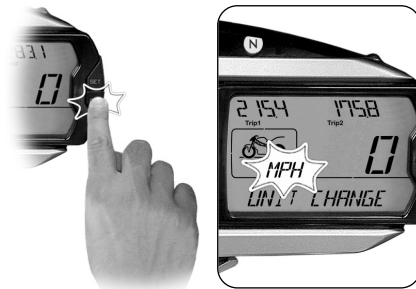

► Press “OK” for over seconds to confirm the new measurement units.





4.4.4. Chronometer

□ Lap time recording

▶ Turn on the chronometer (“CHRONO” mode) to record the time taken to cover a lap.



▶ Press the headlight button to start recording the time. The colon that separates the minutes from the seconds and from the tenths of a second will start blinking. Now, the instrument is recording the time.





► Press the headlight button again to record the time taken to cover the 1st lap. At the same time, the instrument starts recording the time taken to cover the second lap.

The time taken to cover the first lap is saved and is displayed on “LAST LAP”, until it records the time taken to cover the next lap.



► If using the chronometer again, every time you press the headlight button, it records a time. The instrument can record up to 100 consecutive times.

If the time taken to cover the last lap is lower than the time measured during the earlier laps, the new time is displayed on “BEST LAP”.





□ Data display

Once all times have been recorded, they may be displayed.

- ▶ Access “CHRONO” and press “SET” for over four seconds until “CHRONO MENU” appears.



WARNING

The display modes may be changed or set when the engine is off, the gear must be in neutral, the motorbike must be stationary with your feet on the ground. Do not change the display while driving.

- ▶ Press “SET” for less than four seconds until “LAPS VIEW” appears.

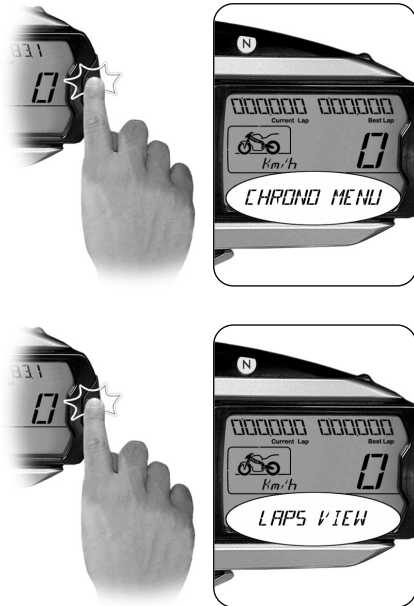



▶ Press “OK” to display the fastest lap time (“BEST LAP”) and the relevant lap number.

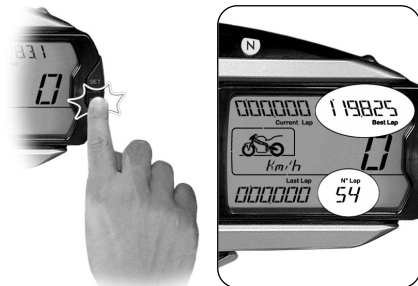

▶ Then, press the headlights button repeatedly to display all the recorded times since the 1st lap, in a sequence.

▶ Once all times have been displayed, press “SET” to quit “LAPS VIEW” and move on to the next mode.

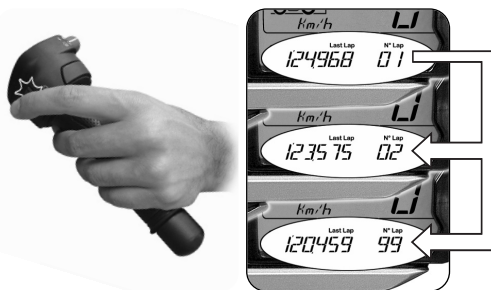

GB 4



□ How to delete data

To delete the saved data, proceed as follows:

- ▶ Access “CHRONO” and press “SET” for over four seconds until “CHRONO MENU” appears.



WARNING

The display modes may be changed or set when the engine is off, the gear in neutral, the motorbike stationary with your feet on the ground. Do not change the display while driving.

- ▶ Press “SET” repeatedly for less than four seconds until “BEST LAP RESET” appears.

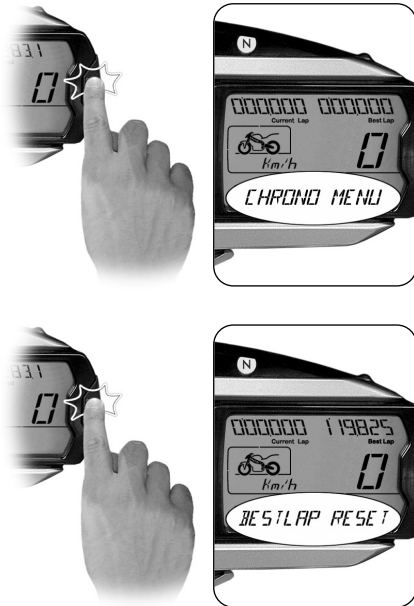



► Press “OK” for over four seconds until “BEST LAP” starts blinking.



► Now, press “OK” for less than four seconds to delete the value. Otherwise, press “SET” for over four seconds to stop the deletion procedure.



GB 4



▶ Press “SET” for less than four seconds until “LAPS RESET” appears.

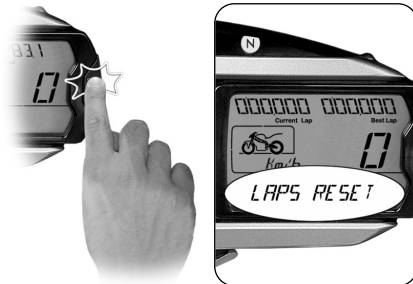

▶ Press “OK” for over four seconds until “LAST LAP” starts blinking.



4 GB



► Now, press “OK” for less than four seconds; all the saved times are deleted. Otherwise, press “SET” for over four seconds to stop the deletion procedure.

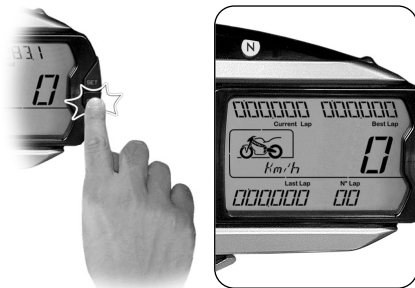
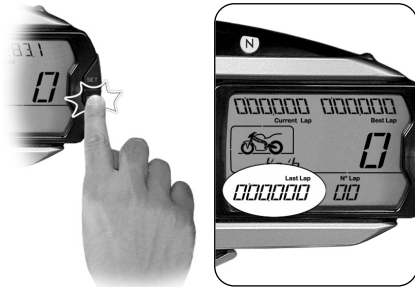

► Press “OK” again to quit “LAPS RESET” and go back to Chronometer Mode.

GB 4



4.4.5. "TC" Mode

► Press "SET" in order to access to "TC" mode, then press "SET" for over four seconds until "TC LEVEL" appears. The current traction control level is the same as the one shown on the display.



WARNING

The display modes may be changed or set when the engine is off, the gear in neutral, the motorbike stationary with your feet on the ground. Do not change the display while driving.

► Press "OK" for less than four seconds: the traction control level rises up to the next value. Such value may range between 0 and 8.

► Press "OK" for over four seconds to confirm the selected traction control level.

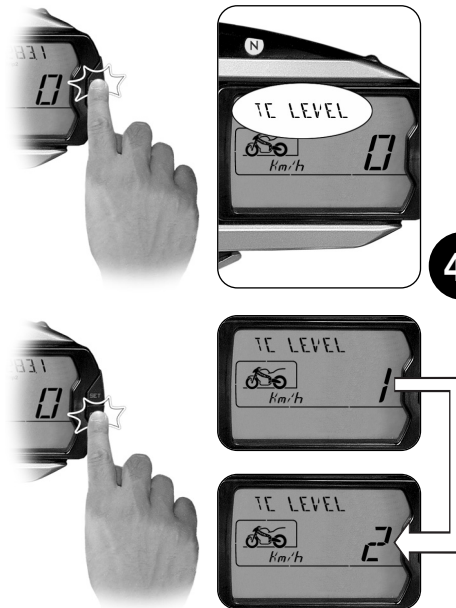



4.4.6. "IMMOBILIZER" Mode

In the event of a breakdown, the system might fail to recognise the starter key code and prevent the engine starting. To let the engine start, enter the secret code, which is on the MV CodeCard that was handed out to you with the motorbike.

▶ Remove the lid from the box on the back of the MV Code Card and read the secret electronic code of the starter key (the figure shows a random code, for information only).

▶ Access "IMMOBILIZER" and press "SET" for over four seconds until "INSERT CODE" appears.



WARNING

The display modes may be changed or set when the engine is off, the gear in neutral, the motorbike stationary with your feet on the ground. Do not change the display while driving.

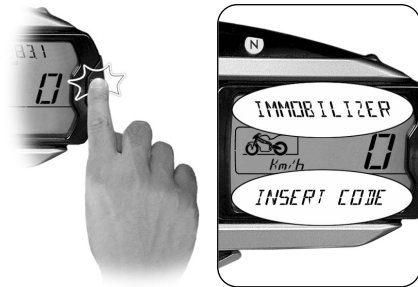



▶ Press “SET” for less than four seconds to set the first digit of the code.

▶ Press “OK” for less than four seconds to set the first digit between 0 and 9.

▶ Once the digit has been selected, press “OK” for over four seconds to confirm the first digit of the code. Now, you can set the second digit of the code.

▶ Do the same to set the other four digits of the code.

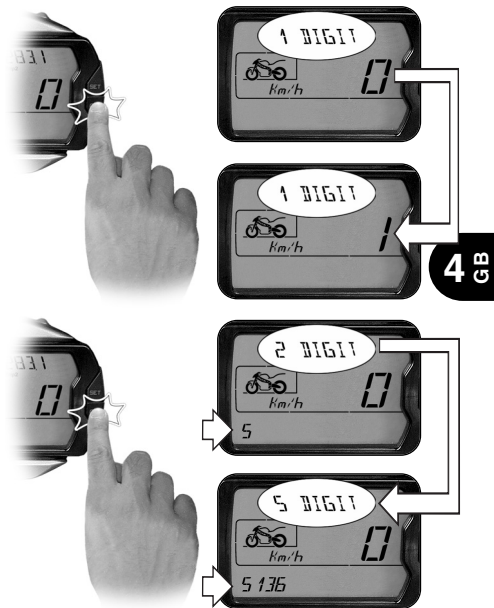



► Once the full code has been entered, “CONFIRM-CODE” appears on the display. Press “OK” for over four seconds to confirm the code.

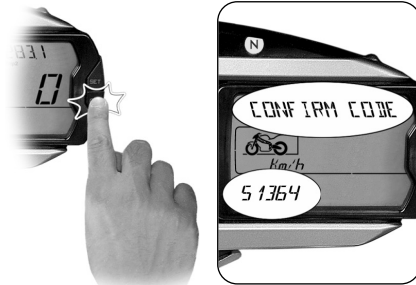

► If the entered code is recognised by the system, “VALID CODE” appears. The dashboard display goes back to “RUN”. The engine may be started.

► If the entered code is wrong, “NOTVALID CODE” appears. The system will not let the engine start; the display goes back to “INSERT CODE”. Repeat the code entry procedure from the start, taking care of setting all the right digits shown on your MV Code Card. If the problem persists, contact a MV Agusta licensed service centre.

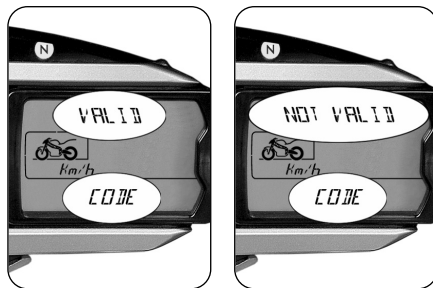



4.4.7. How to select the mapping of the control unit *

In some Brutale models, you may select a special mapping of the control unit, which will enable you to achieve higher power and efficiency for a briskly driving experience.

The mapping of the control unit can be selected by pressing the start button when the engine is switched on. "SPORT" appears on the dashboard display to show the mapping has been selected.



WARNING

The mapping selection may be changed or set when the engine is running, the gear in neutral, the motorbike stationary with your feet on the ground. Do not change the display while driving.

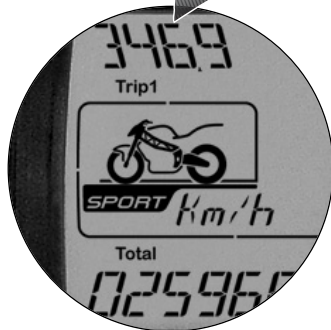

4 GB

(*): This function is present only on certain models



4.4.8. Warning/malfunction alerts

The dashboard may highlight the presence of a fault or a malfunction during different using conditions of the motorcycle.

► *Engine start:* As you turn the ignition switch to the ON position, the instruments and the warning lights will go through the self-diagnostic cycle. If the self-diagnostic cycle detects a fault in the vehicle, the display shows the warning alert shown in the picture. In particular, this message highlights the vehicle part or device on which the fault has been detected.

► Press “OK” button to access to “RUN” mode.



WARNING

If a fault is detected on the vehicle when the engine is off, do not start engine and contact an authorized MV Agusta centre.





► *Fault during vehicle riding:* If a fault is detected during riding, the lower portion of the display shows the warning alert shown in the picture.

**WARNING**

If a fault is detected during riding, stop the vehicle and contact an authorized MV Agusta centre.

► After the vehicle is stopped, the display shows the warning message highlighting the vehicle part or device on which the fault has been detected.





► *High coolant temperature:* If a high value of the coolant temperature is detected, the display shows the warning alert shown in the picture. This message may appear during every using condition of the vehicle.

**WARNING**

If the coolant temperature is high, stop the motorbike and check the coolant level. If it needs to be filled up, contact a MV Agusta licensed service centre (see § 3.8). If the warning alert appears even if the level is adequate, stop driving and contact a MV Agusta licensed service centre.





4.5. Refuelling



WARNING

Petrol and its fumes are highly toxic and flammable. Avoid contact and inhalation. When refuelling, switch off the engine, avoid smoking, and keep away from flames, sparks and heat sources. Perform refuelling in the open air or in a well ventilated area.



CAUTION

Only use unleaded fuel with a R.O.N. octane rating of 95 or higher. The green dot on the lower side of the tank cap serves as a reminder of this.

- ▶ Lift the dust cover.
- ▶ Insert the key into the lock and rotate it clockwise.

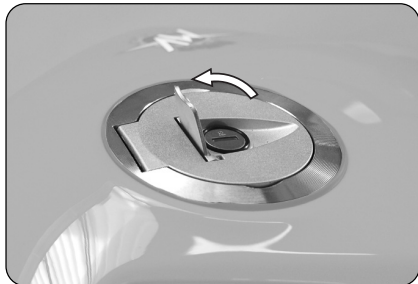

4 GB



- ▶ Lift the tank cap and operate the refuelling.

**WARNING**

Overfilling the tank may cause the fuel to overflow as a result of the expansion due to the heat from the engine or to exposure to sunlight. Fuel spills can catch fire. The level of the fuel in the tank must never be higher than the base of the filler.

GB 4

- ▶ After refuelling, press down the tank cap while rotating the key clockwise to facilitate the locking. Then release the key and remove it.

**CAUTION**

Immediately wipe the overflowed fuel with a clean cloth, to avoid damage to the painted or plastic surfaces.

**WARNING**

Verify that the tank filler cap is correctly closed before using the motorcycle.





4.6. Glove compartment

- ▶ Insert the key into the lock.
- ▶ Rotate the key clockwise while slightly pushing the driver's saddle. Lift the saddle and remove it.

In order to reassemble the above mentioned part, you must perform the following operations:

- Rotate the key into the lock
- Press down the rider seat
- Release the key
- Press down the seat once more, so to make sure of its firm coupling to the frame.

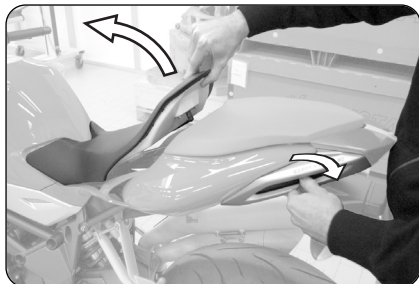

WARNING

Every time you lift or remove the rider seat and every time the vehicle is used, make sure that the above mentioned part is correctly placed and that it is firmly secured to the motorcycle framework.



4.7. Parking the motorcycle

□ Using the sidestand



CAUTION

Park the motorcycle safely on solid ground. On slopes, engage the first gear and park the vehicle so that the front wheel faces uphill. Remember to put the gear lever in the neutral position before restarting the engine. Never leave the vehicle unattended while the engine key is in the dashboard.

- ▶ Using your foot, lower the sidestand as far as it will go, and then slowly tip the motorcycle toward you to bring the stand supporting foot into contact with the ground's surface.





□ Using the rear stand

Insert the stand pin into the rear wheel axle hole on the left side of the motorcycle. Rest the stand on the ground and, pressing down on the stand, lift the vehicle until it reaches a stable condition.



CAUTION

This operation is best carried out with two people.

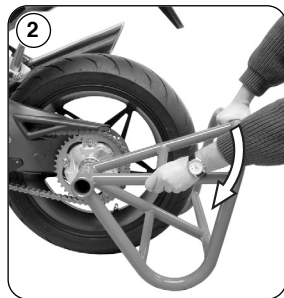
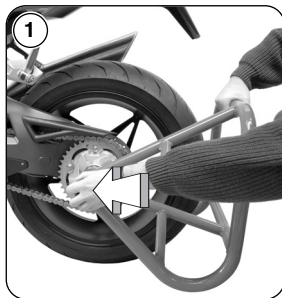



5.1. List of adjustments

There are many adjustments that can significantly improve the ergonomics, geometry and safety of the motorcycle.

However, since an incorrect adjustment of particularly important components can lead to dangerous situations, some of the above adjustments must be performed only by authorized MV Agusta Service Centers.



WARNING

All adjustments must be performed when the vehicle is stationary.



(E) Rearview mirror adjustment (§5.5.)

(F) Front suspension adjustment (§5.6)

(A) Front brake lever
adjustment (§5.3.)

(L) Headlight adjustment (§5.8.)

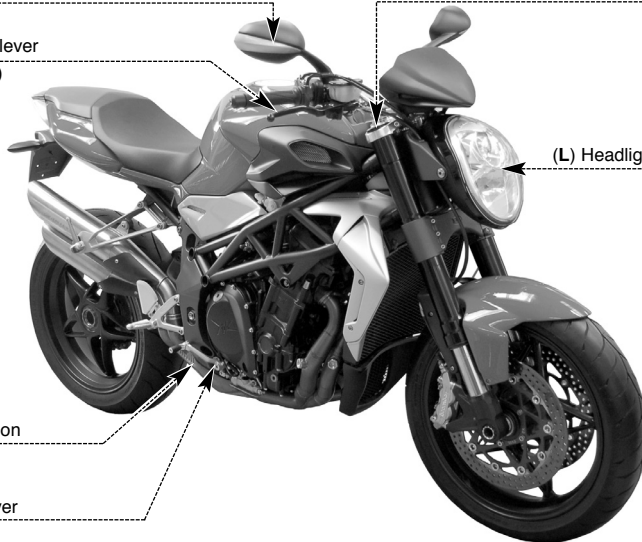

(G) Rear suspension
adjustment (§5.7.)

(D) Rear brake lever
adjustment (§5.2.)

4 GB



(E) Rearview mirror adjustment (§5.5.)

(F) Front suspension adjustment (§5.6)

(B) Clutch lever adjustment (§5.4.)

(C) Gear lever adjustment (§5.2.)

(H) Drive chain adjustment (§5.2.)

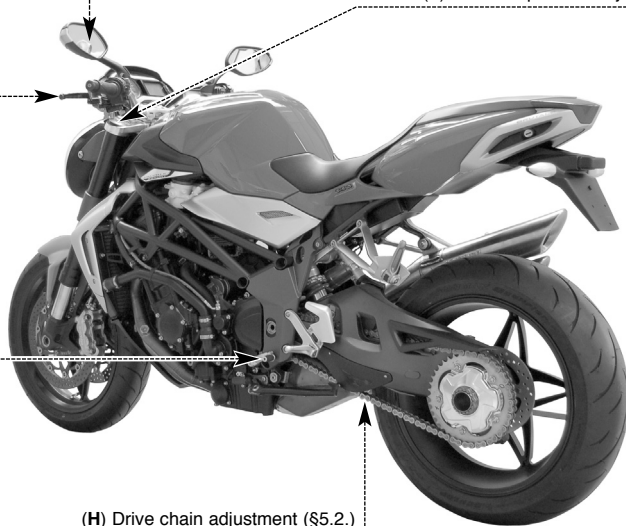



5.2. List of adjustments

	A - Front brake lever adjustment: Optimizes the grip to suit the rider's needs (§5.3).	
	B - Clutch lever adjustment: Optimizes the grip to suit the rider's needs (§5.4).	
	C - Gear lever adjustment: Optimizes the position of the lever to suit the rider's needs.	
	D - Rear brake lever adjustment: Optimizes the position of the lever to suit the rider's needs	
	E - Rearview mirror adjustment: Optimizes the orientation of the rearview mirrors (§5.5). WARNING: Do not operate the screw fixing the rearview mirror to the handlebar. If this screw needs to be tightened, contact your MV Agusta dealer.	
	F - Front suspension adjustment: The following can be adjusted to adapt the response of the suspension to the rider's preference: <ul style="list-style-type: none">- spring preload (§5.6.1.)- rebound damper (§5.6.2.)- compression damper (§5.6.3.)	
	G - Rear suspension adjustment: The following can be adjusted to adapt the response of the suspension to the rider's preference: <ul style="list-style-type: none">- spring preload- geometry height	
	<ul style="list-style-type: none">- rebound damper (§5.7.1.)	
	H - Drive chain adjustment: To ensure safe and effective transmission of power.	
	L - Headlight adjustment: To adjust the range of the light beam to the geometry of the motorcycle (§5.8).	



5.3. Adjusting the front brake lever

While pulling the lever to counter the action of the spring, turn the ring clockwise or counterclockwise to move the lever away or towards the hand-grip respectively.

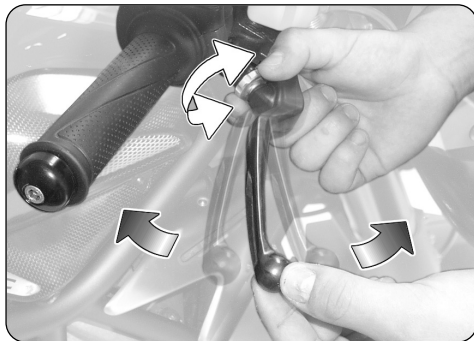

5.4. Adjusting the clutch lever

While pulling the lever to counter the action of the spring, turn the ring clockwise or counterclockwise to move the lever away or towards the hand-grip respectively.





5.5. Adjusting the rearview mirrors

Press the mirror at the points shown in the figure to adjust its position in the four directions.

Perform the adjustment on both the rearview mirrors. It is recommended to sit on the vehicle in order to optimize the rearview mirrors adjustment.





5.6. Adjusting the front suspension



NOTE

The adjustment of the suspensions must be preferably performed with the fuel tank full.



Rebound damper

Spring preload

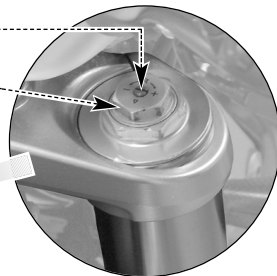

Compression damper

Spring preload

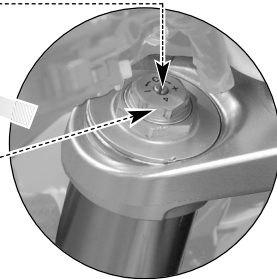



5.6.1. Spring preload

The adjustment is obtained from the standard position, which is found by fully turning the adjusting nut counterclockwise and then clockwise (see enclosed table). Rotate clockwise to increase the spring preload or counterclockwise to decrease it.



5.6.2. Rebound damper (front suspension)

The adjustment is obtained from the standard position, which is found by fully turning the screw clockwise and then counterclockwise (see enclosed table). Rotate clockwise to increase the damping action or counterclockwise to decrease it.





5.6.3. Compression damper (front suspension)

The adjustment is obtained from the standard position, which is found by fully turning the screw clockwise and then counterclockwise (see enclosed table). Rotate clockwise to increase the damping action or counterclockwise to decrease it.





5.7. Adjusting the rear suspension



WARNING: The high temperature of the exhaust pipes can cause burns. Before adjusting the rear suspension, shut off the engine and wait until the exhaust pipes have thoroughly cooled.

NOTE: The adjustment of the suspensions must be preferably performed with the fuel tank full.



Rebound damper





5.7.1. Rebound damper (rear suspension)

The adjustment can be performed by operating on the screw placed on the lower side of the shock absorber, and it is obtained from the standard position.

This position is found by fully rotating the screw clockwise and then counterclockwise until you hear the first click; from this position, turn the screw counterclockwise until you reach the standard position (see enclosed table).

Rotate clockwise to increase the damping action or counterclockwise to decrease it.

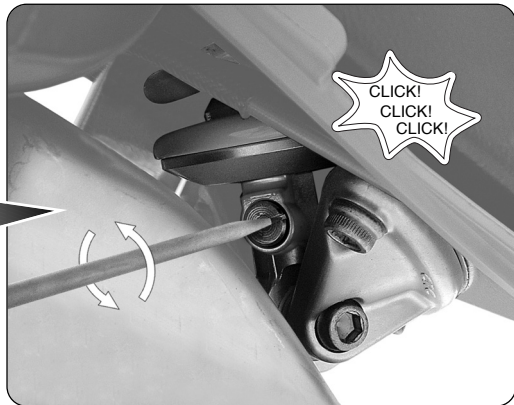



5.8. Headlight adjustment

Place the vehicle at a distance of 10 m from a vertical wall. Make sure that the motorcycle is placed on an even horizontal surface, and that the headlight's optical axis is perpendicular to the wall.

The vehicle must be held in an upright position. Measure the "X" distance between the headlight center and the ground surface, then trace a small cross on the wall at the same height.

When you turn the headlight on, the upper boundary line between the dark area and the lighted area must be at an height equal or lower than the 9/10 of the headlight center height (X).

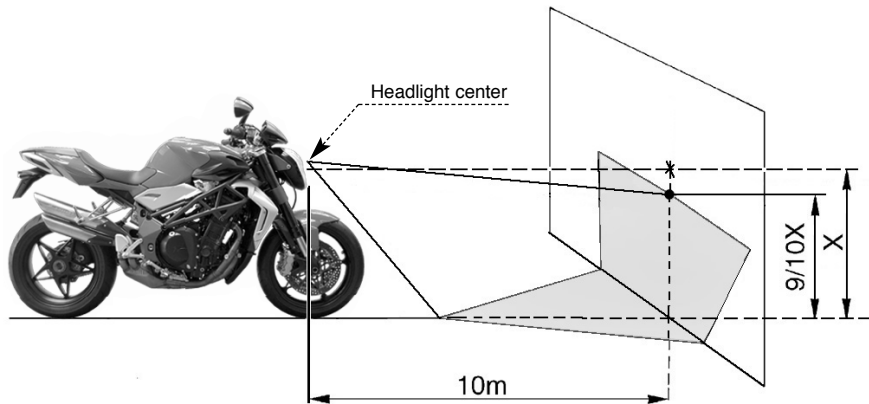



The headlight adjustment can be performed by rotating the screw shown in the picture. Rotate clockwise to incline the headlight downwards, counterclockwise to incline it upwards. The possible adjustment range is equal to $\pm 4^\circ$ from the standard position.

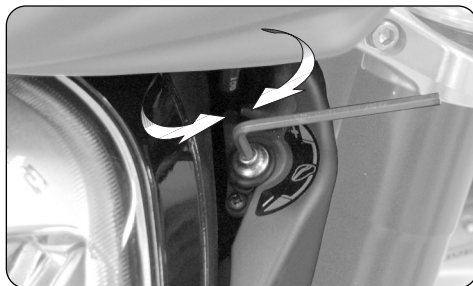

GB 5



Information

MV Agusta S.p.A. is committed to a policy of constant improvement; therefore, you may find slight differences between the information provided in this document and the vehicle you purchased. MV Agusta motorcycles are exported in several countries, in which different rules and regulations (concerning both the Highway Code and the homologation procedures) are in force. Relying on your understanding, MV Agusta S.p.A. deems it necessary to reserve the right to change its products and the related documentation at any time and without notice.

We suggest to often visit the Internet site **www.mvagusta.it** in order to obtain informations and updates about the MV Agusta products and the related documentation.



Respect and defend natural environment

Everything we do affects the whole planet as well as its resources.

MV Agusta, in order to protect the interests of the community, awakens the Customers and the Technical Assistance operators to use the vehicle and dispose of its replaced parts respecting the laws in force concerning environmental pollution and waste disposal and recycling.

© 2010

This document may not, in whole or in part, be reproduced without prior consent, in writing, from MV Agusta S.p.A.

Part no. 8000B3247

Edition no. 2 - July 2010



NOTES

5
GB

BRUTALE
990R

MV AGUSTA



Manuel d'utilisation

Version Française

Cher client,

Nous vous remercions de la confiance que vous nous accordez et vous félicitons pour votre nouvelle Brutale 990 R. Grâce à la passion et aux efforts de ses techniciens, MV Agusta présente aujourd'hui aux amateurs un produit à l'esthétique inédite associée à une partie cycle raffinée. Ces éléments, qui ont caractérisé toutes les créations de la maison MV Agusta tout au long de sa glorieuse histoire.

Le résultat est une moto exclusive qui se place, de par ses caractéristiques esthétiques et fonctionnelles et ses innombrables innovations techniques, au plus haut niveau que le marché motocycliste puisse offrir à l'heure actuelle.

Les solutions qui ont été mises en place confère à la Brutale 990 R ce caractère unique qui la rapproche des autres modèles de la famille MV Agusta tout en consolidant une philosophie de conception qui privilégie un effort constant de recherche, l'innovation technologique et l'amour pour le détail et en donnant la possibilité à tous ceux qui vivent leur passion pour la moto en pleine liberté de posséder un objet unique au monde qui s'impose avec fermeté sur la place mondiale.

Si vous désirez plus d'information, n'hésitez pas à contacter notre Service Après-Vente MV Agusta.

Bon divertissement

*Claudio Castiglioni
Président
MV Agusta*



TABLE DES MATIÈRES

<i>Chap.</i>	<i>Sujets abordés</i>	<i>page</i>
1	GÉNÉRALITÉS	5
1.1.	Utilité de ce livret	5
1.2.	Symboles	6
1.3.	Contenu du support digital	7
1.4.	Données d'identification	8
2	INFORMATIONS SUR LA SÉCURITÉ	11
2.1.	Utilisation admise du véhicule	11
2.2.	Entretien	11
2.3.	Accessoires et modifications	12
2.4.	Chargement du véhicule	12
3	COMMANDES ET APPAREILS	14
3.1.	Position des commandes et appareils	14
3.2.	Béquille latérale	16
3.3.	Commandes au guidon côté gauche	17
3.4.	Commandes au guidon côté droit	19
3.5.	Contacteur principal et verrouillage de direction	22
3.6.	Sélecteur de vitesses	26
3.7.	Appareils et voyants	27
3.7.1.	Voyants lumineux	28
3.7.2.	Écran multifonctions/Écran vitesse et température de l'eau	29
3.8.	Tableau des lubrifiants et liquides	30

<i>Chap.</i>	<i>Sujets abordés</i>	<i>page</i>
4	UTILISATION	31
4.1.	Utilisation de la moto	31
4.2.	Rodage	32
4.3.	Démarrage	34
4.4.	Sélection et modification des fonctions d'affichage	38
4.4.1.	Sélection des fonctions d'affichage	39
4.4.2.	Mise à zéro des fonctions des compteurs kilométriques partiels	43
4.4.3.	Réglage des unités de mesure	47
4.4.4.	Chronomètre	49
4.4.5.	Modalité TC	57
4.4.6.	Modalité IMMOBILIZER	58
4.4.7.	Sélection représentation de la centrale	61
4.4.8.	Messages d'avertissement/pannes	62
4.5.	Approvisionnement en carburant	65
4.6.	Accès à la boîte à gants	67
4.7.	Stationnement de la moto	68
5	RÉGLAGES	70
5.1.	Liste des réglages	70
5.2.	Tableau des réglages	73
5.3.	Réglage du levier de frein avant	74
5.4.	Réglage du levier d'embrayage	74



TABLE DES MATIÈRES

<i>Chap.</i>	<i>Sujets abordés</i>	<i>page</i>
5.5.	Réglage des rétroviseurs	75
5.6.	Réglage de la suspension avant	76
5.6.1.	Précharge du ressort	77
5.6.2.	Dispositif hydraulique de freinage en détente (suspension avant)	77
5.6.3.	Dispositif hydraulique de freinage en compression (suspension avant)	78
5.7.	Réglage de la suspension arrière	79
5.7.1.	Dispositif hydraulique de freinage en détente (suspension arrière)	80
5.8.	Réglage du projecteur avant	81



1.1. Utilité de ce livret

Le présent Manuel fournit les informations nécessaires pour une utilisation correcte et sûre de la moto.

Est également fourni un Manuel Rapide de poche contenant les informations essentielles pour l'utilisation du véhicule.

Le Manuel est fourni aussi sous format électronique (.pdf) sur le présent supporte digital et peut être imprimé ou affiché sur tout PC avec système Windows ou Mac.

Nous vous recommandons de lire attentivement le Manuel avant d'utiliser la moto et de vous assurer que toutes les personnes utilisant la moto ont lu attentivement le Manuel.

Nous vous conseillons de toujours avoir sur vous le Manuel Rapide avec vos données d'identification et celles de la moto.



Copyright
MV AGUSTA Motor Spa
Tous droits réservés



1.2. Symboles

Les parties du texte particulièrement importantes qui concernent la sécurité de la personne et l'intégrité de la moto, sont mises en évidence par les pictogrammes suivants:



Danger - Attention: le non respect partiel ou total de ces prescriptions peut être source de danger pour soi-même et pour autrui.



Prudence - Précautions: le non respect partiel ou total de ces prescriptions peut être cause de dommages pour la moto.

Pour indiquer les personnes autorisées à exécuter les opérations de réglage et/ou d'entretien, celles-ci sont mises en évidence par les pictogrammes suivants:



Informations sur les opérations permises au motard.



Informations sur les opérations qui doivent être effectuées uniquement par le personnel autorisé.

Pour mettre en évidence les informations supplémentaires, les symboles suivants sont utilisés:



Le symbole  indique la nécessité d'utiliser un outil ou un appareil spécial pour l'exécution correcte de l'opération décrite.



Le symbole “§” renvoie au chapitre correspondant au numéro qui l'accompagne.



1.3. Contenu du support digital

Le présent support digital contient en sus du présent Manuel le Manuel d'Entretien, le Manuel Rapide (est également fournie une version imprimée), le Guide des Concessionnaires et le Livret de Garantie, le Carnet de garantie et le Catalogue des pièces de rechange spéciaux MV Agusta.

Au moment de vous remettre la moto, votre Concessionnaire vous a remis le Certificat de Garantie et de Préparation à la route.

Nous vous invitons à conserver le Certificat avec les documents de la moto et les coupons qui vous seront remis à toutes les opérations de révision prévues par la garantie.

IMPORTANT

La copie du Certificat de Garantie et de Préparation à la route destinée à MV Agusta doit être remplie par le Concessionnaire et retournée à l'usine dans un délai de 10 jours après la date d'immatriculation.

Les copies des coupons de révision doivent toujours être remplies par le concessionnaire et retournées à MV Agusta dans un délai de 10 jours après la date d'exécution des interventions.



1.4. Données d'identification

- 1) numéro de série du cadre
- 2) numéro de série du moteur
- 3) données d'homologation

► Identification de la moto

La moto est identifiable grâce au numéro de série du cadre. Pour les commandes de pièces détachées, il peut être nécessaire d'indiquer également le numéro de série du moteur, le code couleur et le numéro d'identification des clés.

Il est conseillé de noter les données principales dans les espaces ci-dessous:

CADRE N.: _____

MOTEUR N.: _____



► Identification des clés de la moto

Une clé est fournie en double exemplaire, elle sert pour le contacteur de démarrage et pour toutes les autres serrures. Garder le double en lieu sûr.

Il est indispensable de connaître le numéro d'identification de la clé pour en demander un double. Le numéro d'identification de la clé est imprimé sur la MV Code Card fournie avec les clés de démarrage.

**1** FR

► Identification de la combinaison de couleur de la moto

Le code couleur est indispensable pour la commande de pièces détachées de la carrosserie. On peut lire ce code sur la plaque qui se trouve sur la partie droit inférieure du réservoir d'essence.

Pour accéder à la plaque du code couleur, il faut enlever le flanc réservoir droit.

Retirez la partie arrière du flanc réservoir gauche comme représenté sur la figure.

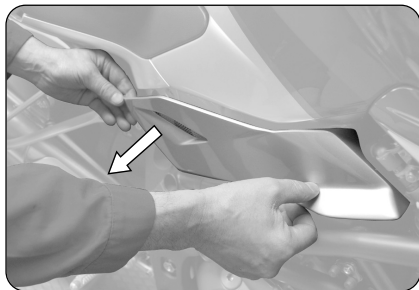

**FR 1**

Enlevez le flanc réservoir droit en le tirant vers la partie arrière de la moto.

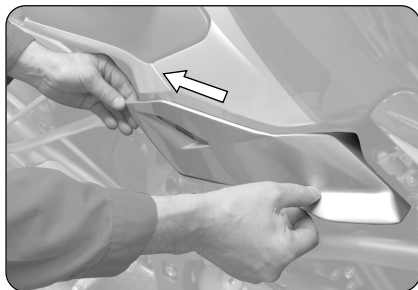

Après avoir enlevé le flanc réservoir gauche, on peut lire la plaque du code couleur. Cette plaque porte la mention du code couleur de la moto qui détermine la couleur des parties de la carrosserie.

Il est conseillé de noter le numéro d'identification du code couleur de la moto dans l'espace suivant:

CODE COULEUR:

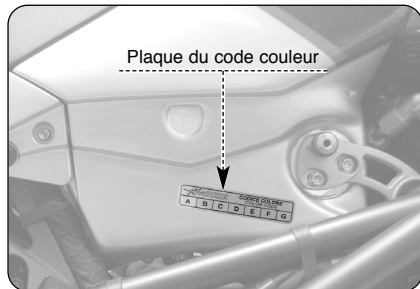



2.1. UTILISATION ADMISE DU VEHICULE

La moto a été conçue pour une utilisation sur route et autoroute.



ATTENTION

Il est possible d'utiliser occasionnellement la moto sur piste mais pas dans le cadre de compétitions.

En raison des contraintes supplémentaires auxquelles est alors soumise la moto, nous vous recommandons de faire contrôler par un Centre d'Assistance MV Agusta les conditions de la moto avant et après l'emploi. Toute autre utilisation est interdite et expressément exclue.

Vous trouverez d'autres informations sur l'utilisation de la moto dans la section 4 du présent Manuel.

2.2. ENTRETIEN

Pour garantir l'efficacité et la fiabilité maximum du véhicule, il est indispensable d'effectuer les opérations d'entretien indiquées dans le Manuel d'Entretien.

MV Agusta insiste sur le fait que toutes les opérations d'entretien doivent être effectuées uniquement par un personnel qualifié appartenant à un Centre d'Assistance MV Agusta.

Si toutefois vous décidez de faire exécuter les interventions d'entretien par des ateliers non agréés, nous vous conseillons de vous assurer qu'ils disposent des instruments spécifiques nécessaires à de telles opérations.



ATTENTION

La garantie MV Agusta pourrait ne pas être valable si les ateliers non agréés ont effectué des interventions sur la moto de manière incorrecte et non prévue par les Circulaires Techniques et les Manuels d'Atelier MV Agusta.



2.3. ACCESSOIRES ET MODIFICATIONS



ATTENTION

Pour garantir la sécurité de ses Clients, MV Agusta interdit toute modification aux motos.

Toutefois, vous pouvez personnaliser votre moto en utilisant les Accessoires MV Agusta.



ATTENTION

L'installation de quelques-uns de ces accessoires peut annuler l'homologation de la moto et entraîner la non-utilisation sur route publique.

Dans le doute, nous vous invitons à contacter votre Concessionnaire de confiance pour identifier les accessoires les plus appropriés à vos exigences.

2.4. CHARGEMENT DU VÉHICULE

Le véhicule a été conçu pour être utilisé par un pilote et le cas échéant un passager. Pour l'utiliser en toute sécurité et dans le respect des dispositions du code de la route, il est obligatoire de ne jamais dépasser le poids lourd total maximum admis dont le valeur est indiquée ci-dessous.

BRUTALE 990 R

Poids total maximum	370 kg
Poids de charge maximum	180 kg

Le poids total maximum est la somme des poids suivants, conformément à la directive CEE 92/61:

- poids de la moto;
- poids du pilote;
- poids du passager;
- poids de la charge et des accessoires.

**ATTENTION**

Etant donné que le chargement a un impact énorme sur la maniabilité le freinage, les performances et les caractéristiques de sécurité de votre moyen de transport, prenez toujours les précautions suivantes.

- **NE SURCHARGEZ JAMAIS LE MOTOCYCLE !** L'utilisation d'une moto surchargée peut provoquer des dégâts aux pneumatiques, des pertes de contrôle ou des accidents graves. Vérifiez que le poids total du pilote, du passager, du chargement et des accessoires ne dépasse pas la cha



3.1. Position des commandes et appareils

FR 3

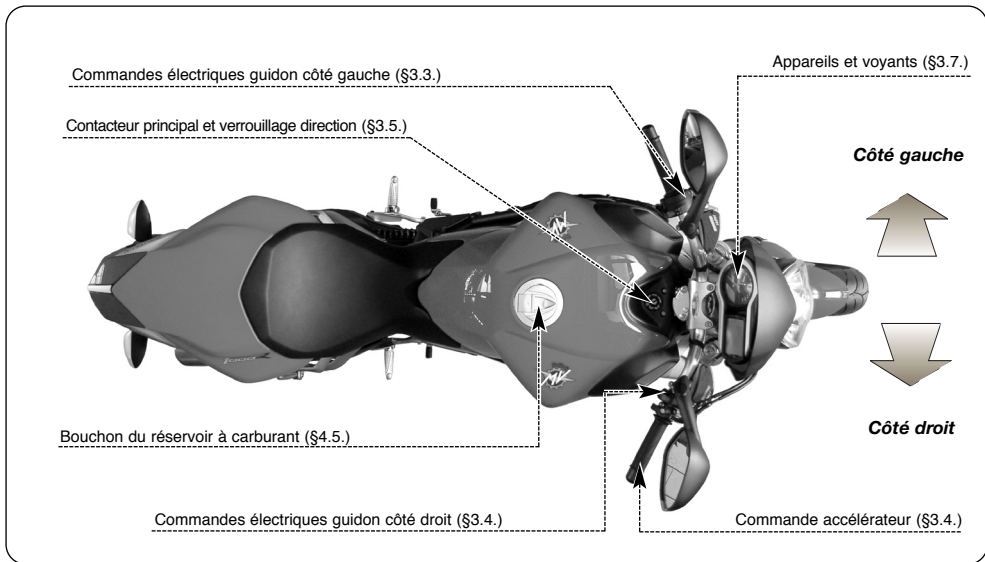

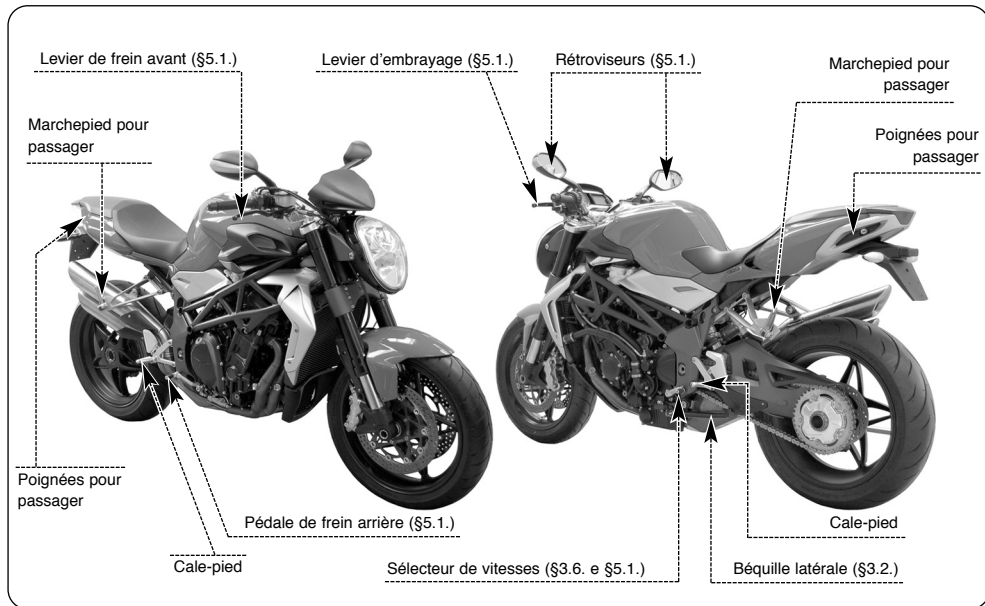



3.2. Béquille latérale

La béquille latérale est équipée d'un contacteur qui empêche à la moto de démarrer avec la béquille baissée.

Si le sélecteur de vitesses est actionné pour mettre la moto en mouvement lorsque le moteur tourne avec la béquille abaissée, le contacteur coupe le courant au moteur et provoque son arrêt.

Dans le cas où la moto se trouve en condition de stationnement (béquille baissée) avec un rapport engagé, le contacteur empêche le démarrage du moteur pour éviter tout risque de chute accidentelle.



Contacteur de sûreté

Béquille latérale

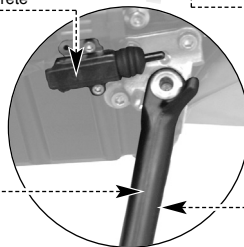

Béquille latérale

Double ressort de rappel



3.3. Commandes au guidon côté gauche

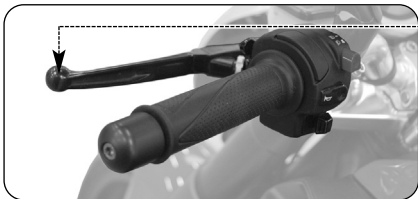

Levier d'embrayage

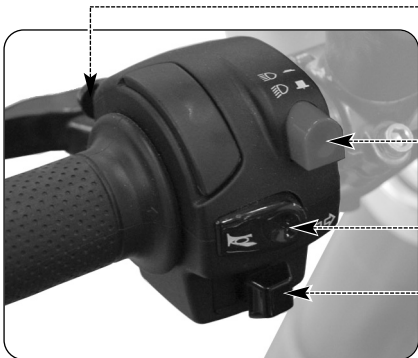

Tirer ou relâcher la poignée pour débrayer ou embrayer.



Bouton de clignotement des phares

Appuyer sur le bouton à répétition.

Inverseur code/phare

Bouton sorti ■ : feu de croisement 
Bouton enfoncé ▬ : feu de route 

Bouton de l'avertisseur sonore

Appuyer pour utiliser l'avertisseur.

Poussoir de clignotants

En le déplaçant vers la droite ou la gauche on allume les clignotants correspondants. Le poussoir revient au centre, appuyer dessus pour éteindre les clignotants.



Bouton d'appel de phare

Cette fonction sert pour rappeler l'attention des autres usagers de la route en présence d'une situation dangereuse. Avec le feu de route éclairé, cette fonction est désactivée.

Bouton inverseur code/phare

C'est normalement la fonction code qui s'allume. Lorsque les de trafic et de route le permettent, il est possible d'allumer le feu de route en agissant sur l'inverseur.

Levier des clignotants

Cette fonction permet de signaler aux autres usagers de la route, l'intention de changer de direction ou de voie de circulation.



ATTENTION

Si les clignotants ne sont pas utilisés ou coupés au moment opportun, il peut y avoir un risque d'accidents. En effet, les autres conducteurs pourraient tirer des conclusions erronées concernant la trajectoire du véhicule. Actionnez toujours les clignotants avant de tourner ou de changer de voie. Veillez à les couper dès que la manoeuvre est terminée.

Bouton de klaxon

Cette fonction sert pour attirer l'attention des autres usagers en cas de situations éventuelles de danger.

Levier d'embrayage

Ce levier, à travers un dispositif à contrôle hydraulique, permet de débrayer et d'embrayer.



3.4. Commandes au guidon côté droit

Levier de frein avant

Tirer vers la poignée pour actionner le frein avant

Commande d'accélérateur

Tourner pour régler l'alimentation du moteur.

Levier de démarrage à froid du moteur (Choke)

Tourner dans le sens des aiguilles d'un montre pour les démarrage à froid.
Au bout de quelques secondes, le ramener dans sa position initiale.

Coupe-circuit

Coupe le moteur et empêche le démarrage.

Bouton du démarreur

Actionne le démarreur. Dès que le moteur part, il faut le relâcher.
Une fois le moteur en marche, il sert pour sélectionner les fonctions d'affichage.

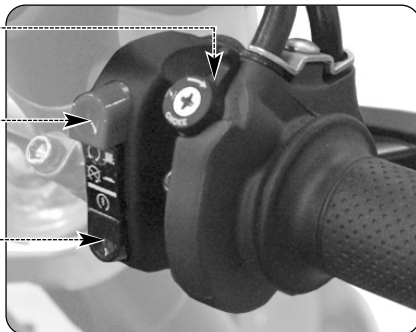
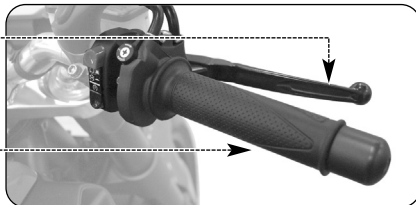



Coupe-circuit moteur

Cette fonction permet d'éteindre le moteur en cas d'urgence. De cette manière, le circuit d'allumage est coupé empêchant le redémarrage du moteur. Pour pouvoir démarrer, ramener le bouton en position de repos.

NOTE

En conditions normales, n'utilisez pas ce dispositif pour couper le moteur.

Bouton de démarrage moteur

Ce dispositif permet le démarrage du moteur. De plus, une fois le moteur démarré, il permet de sélectionner les fonctions de l'affichage du tableau de bord.



RAPPEL

Pour éviter des dommages à l'installation électrique, ne tenez pas le bouton enfoncé plus de 5 secondes consécutives.

Si le moteur ne démarre après plusieurs tentatives, consultez le chapitre "PANNES" du livret.

Levier de démarrage à froid du moteur (Choke)

Le dispositif facilite le démarrage à froid en agissant sur l'alimentation.

NOTE

Cette fonction ne doit être maintenue actionnée que pour un temps limité et dans tous les cas dépendant de la température du moteur ainsi que de l'environnement. Lorsque le régime de ralenti est suffisant pour faire tourner le moteur sans qu'il s'éteigne, ramener la commande de démarrage à froid en position de repos.



Commande d'accélérateur

Ce dispositif permet d'agir sur l'alimentation du moteur pour varier son régime de rotation. Pour actionner le dispositif, il faut faire pivoter la poignée à partir de la position de repos qui correspond au régime de ralenti moteur.

En condition de démarrage à froid (Choke actionné), la répétée rotation de la poignée dans le sens de fermeture des gaz permet de ramener le levier de Choke en position de repos.

Levier frein avant

Cette commande provoque l'actionnement par l'intermédiaire d'un circuit hydraulique du système de freinage de la roue avant.



3.5. Contacteur principal et verrouillage de direction



ATTENTION: Ne pas appliquer de porte-clés ou autre à la clé de contact pour ne pas risquer de gêner la rotation de la direction.



ATTENTION: Ne jamais chercher à changer certaines fonctions du contacteur en cours de route sous peine de perdre le contrôle du véhicule.

FR 3

Contacteur principal et verrouillage de direction

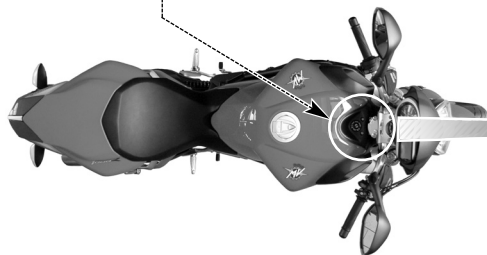

Position "ON"

Position "OFF"

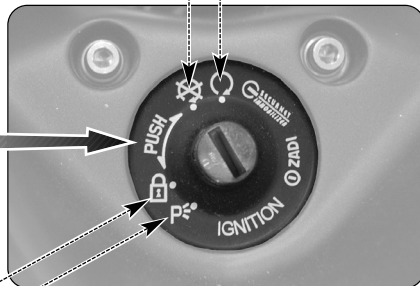

Position "LOCK"

Position "P"



Le contacteur à clé branche et coupe le circuit électrique et le verrouillage de la direction; les quatre positions de commande sont décrites à la suite.

Position "OFF"

Tous les circuits électriques sont coupés. La clé peut être retirée.



Position "ON"

Tous les circuits électriques sont branchés, les appareils et les voyants effectuent l'auto-diagnostic; le moteur peut démarrer. La clé peut être retirée.



3 FR



Rappel-Précautions: Ne pas laisser la clé sur la position "ON" à moteur éteint pendant trop longtemps sous peine d'endommager les composants électriques de la moto.



Position "LOCK"

Braquer le guidon à droite ou à gauche. Pousser légèrement sur la clé et la tourner simultanément en position "LOCK".

Tous les circuits sont coupés et la direction est verrouillée. La clé peut être retirée.

FR 3

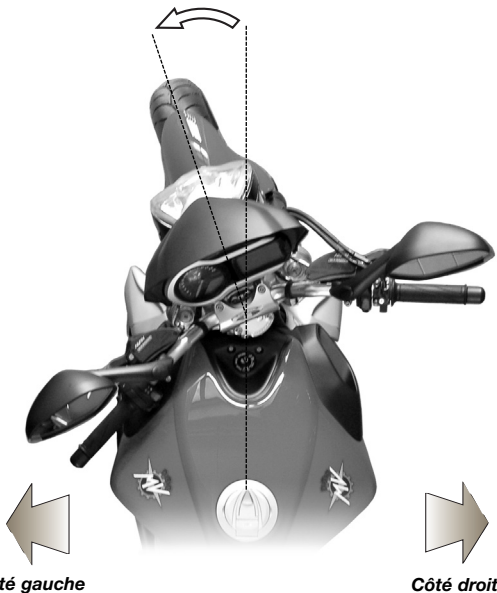
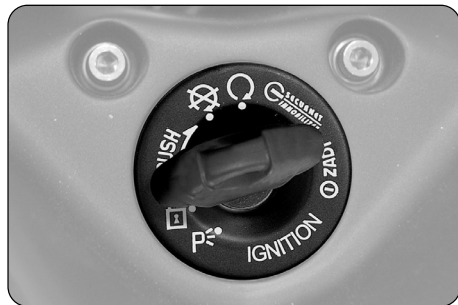



Position "P"

Tourner la clé de la position "LOCK" à la position "P".

Tous les circuits électriques sont coupés à l'exception des feux de stationnement (feux de positions) et la direction est verrouillée.

La clé peut être retirée.



RAPPEL

Ne pas laisser la clé sur la position "P" pendant trop longtemps pour éviter de décharger la batterie de la moto.



3.6. Sélecteur de vitesses

La position **N** "Neutral" correspond au point mort signalé par le voyant correspondant sur le tableau de bord. En déplaçant le sélecteur vers le bas, on engage la première vitesse.

De la même manière, en déplaçant le sélecteur vers le haut, on passe la seconde vitesse et ainsi de suite à mesure que l'on déplace le sélecteur vers le haut, on passe dans l'ordre toutes les vitesses suivantes jusqu'à la sixième.

FR 3



Sélecteur de vitesses

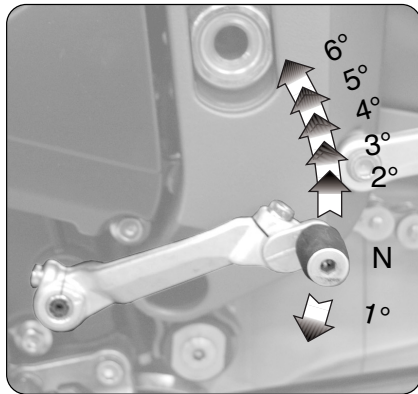



3.7. Appareils et voyants

Les appareils et les voyants sont activés lorsque la clé de contact est mise sur "ON". Après un check-up initial (~7 secondes), les informations correspondent aux conditions générales de la moto à ce moment là.

Voyants lumineux
indicateurs (§3.7.1.)

Compte-tours

Écran vitesse et
température de l'eau
(§3.7.2.)

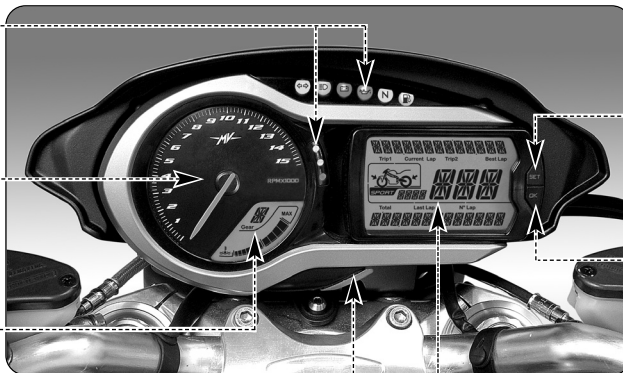

Bouton "SET"
(§3.7.2.)

Bouton "OK"
(§3.7.2.)

Bouton "HAZARD" (§3.7.2.)

Ecran multifonctions (§3.7.2.)



3.7.1. Voyants lumineux

Voyant Feux de route (bleu)

S'allume quand les feux de route sont allumés.

Voyant Pression huile moteur (rouge)

S'allume quand l'huile est à une pression insuffisante.



Danger - Attention: Si il s'allume pendant la marche, s'arrêter immédiatement, contrôler le niveau de l'huile et si nécessaire remplir le réservoir de l'huile auprès d'un centre d'assistance autorisé MV Agusta (voir §3.8). Si le voyant s'allume alors que le niveau est correct, ne pas redémarrer et contacter un centre d'assistance autorisé MV Agusta.

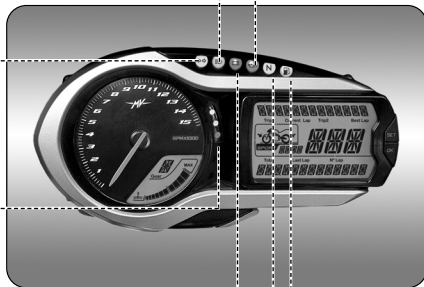

Voyant Clignotants (vert)

S'allume quand les clignotants sont allumés.

Voyant Limiteur de tours (rouge)

S'allume quand le moteur dépasse les 11600 rpm.

Voyant Batterie (rouge)

S'allume quand l'alternateur ne fournit pas une tension électrique suffisante pour charger la batterie. S'il s'allume pendant la marche du véhicule, adressez-vous à un centre d'assistance autorisé.

Voyant Réserve carburant (orange)

S'allume quand le réservoir ne contient plus que 4 litres de carburant environ.

Voyant Levier de vitesses au point mort (vert)

S'allume quand le levier est en position de point mort "Neutral".



3.7.2. Écran multifonction / Écran vitesse et température de l'eau

Écran Rapport de vitesse

Indique le rapport de vitesse actuellement inséré. La position de point mort est indiquée par la lettre "N" (neutral).

Thermomètre

Indique la température du liquide de refroidissement à travers l'allumage d'un nombre variable de segments sur une échelle de mesure graduée. Quand la température se trouve en dehors du champ de fonctionnement normal, les indications suivantes peuvent apparaître:

- sur l'écran apparaît un unique segment clignotant; c'est le signal de température faible.
- tous les segments sont allumés tandis que le segment supérieur clignote; c'est le signal de température élevée.



Danger - Attention: en cas de température élevée, arrêter le véhicule et contrôler le niveau du liquide de refroidissement. Au cas où il serait nécessaire de remplir le réservoir, s'adresser à un centre d'assistance autorisé MV Agusta (voir § 3.8). Si l'indication apparaît et que le niveau est correct, ne pas redémarrer et contacter un centre d'assistance autorisé MV Agusta.

Modalité "SPORT"

Indique la modalité sportive de la centrale d'injection.

Compteur de vitesse

Indique la vitesse. La valeur peut apparaître en kilomètre-heure (Km/h) ou bien en milles par heure (Mph). La valeur maximum est de 320 Km/h (199 Mph).

Bouton "SET"

Appuyer dessus pour sélectionner les chiffres de l'écran pour effectuer les réglages.

Bouton "OK"

Appuyer dessus pour confirmer les chiffres configurés.

Bouton "HAZARD"

Appuyer dessus pour allumer les lumières d'urgence.

Compteur kilométrique total "TOTAL"

Indique le kilométrage total; de 0 à 999999 (Km ou mi)

Compteur kilométrique partiel 1 "TRIP 1"

Indique le kilométrage partiel; de 0 à 999.9 (Km ou mi)

Compteur kilométrique partiel 2 "TRIP 2"

Indique le kilométrage partiel; de 0 à 999.9 (Km ou mi)

Chronomètre

Indique les temps mesurés à l'aide de la fonction chronomètre

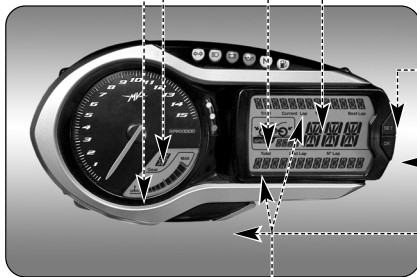



3.8. Tableau des lubrifiants et liquides

Description	Produit préconisé	Caractéristiques
Huile moteur	AGIP RACING 4T 10W/60 (*)	SAE 10W/60 - API SJ
Liquide de refroidissement	AGIP ECO - PERMANENT	Glycol-éthylène dilué à 50% avec eau distillée
Liquide d'embrayage et freins	AGIP BRAKE FLUID DOT4	DOT4
Huile de graissage de la chaîne	MOTUL CHAIN LUBE ROAD	-

* : Pour la disponibilité du produit conseillé, MV Agusta conseille de s'adresser directement aux propres concessionnaires autorisés. L'huile moteur AGIP Racing 4T 10W/60 a été réalisée spécialement pour le moteur de la motocyclette Brutale. Au cas où le lubrifiant décrit ne serait pas possible à trouver, MV Agusta conseille d'utiliser des huiles complètement synthétiques avec des caractéristiques conformes ou supérieures aux normes suivantes:

- Conforme API SJ
- Conforme ACEA A3
- Conforme JASO MA
- Gradation SAE 20 W-50 ou 10 W-60

NOTE

Les caractéristiques indiquées ci-dessus doivent être indiquées seules ou avec d'autres sur l'emballage de l'huile.





4.1. Utilisation de la moto

Cette partie du livret expose les principaux points qui permettent une utilisation correcte de la moto.



ATTENTION

La Votre moto Brutale 990 R montre caractéristiques élevées de puissance et de performances; pour l'utilisation, il est donc requise un niveau adéquat de connaissance du véhicule. Lors de la première utilisation de la moto, il est nécessaire de garder une attitude prudente. Une agressive ou impulsive attitude de conduite peut augmenter les risques d'accidents et représenter un danger pour Votre sécurité et celle d'autrui.



ATTENTION

LES LIMITATIONS CONCERNANT L'UTILISATION ADMISE DU VEHICULE SONT REPORTÉES DANS LA SECTION "INFORMATIONS POUR LA SÉCURITÉ".



4.2. Rodage



Prudence - Précautions: le non respect des indications suivantes peut porter préjudice à la durée et aux performances de la moto.

Le rodage est communément considéré comme une phase appliquée uniquement au moteur. En réalité, il est nécessaire également pour d'autres parties importantes de la moto, en particulier les pneumatiques, les freins, la chaîne de transmission etc. Durant les premiers kilomètres adopter une conduite tranquille.

De 0 à 500 km (de 0 à 300 mi) (A)

Pendant cette période, varier fréquemment le régime de rotation du moteur. Si possible, préférer les parcours en colline légère avec beaucoup de virages et éviter les longues lignes droites



ATTENTION

Les pneumatiques neufs doivent être soumis à un rodage adéquat pour atteindre une efficacité complète. Éviter les accélérations, les virages et les freinages brusques pendant les premiers 100 km. Si la période de rodage initial des pneus n'est pas respectée, il y a risque de dérapage ou de perte de contrôle du véhicule entraînant un grave danger d'accident.



❑ De 500 à 1000 km (de 300 à 600 mi)

Pendant cette période, éviter les efforts prolongés du moteur.

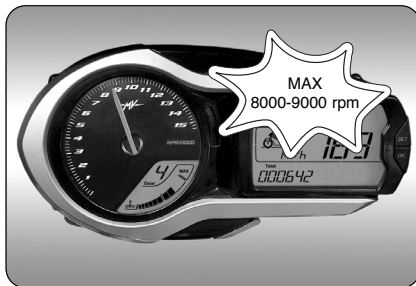

❑ De 1000 à 2500 km (de 600 à 1600 mi)

Pendant cette période, il est possible de pousser un peu plus le moteur sans toutefois dépasser le régime indiqué.

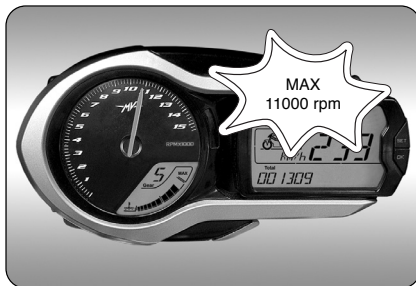



4.3. Démarrage du moteur



ATTENTION

Faire fonctionner le moteur dans un endroit fermé peut être dangereux. Les gaz d'échappement contiennent du monoxyde de carbone, un gaz incolore et inodore qui peut provoquer des décès ou des états graves. Ne faire fonctionner le moteur qu'à l'extérieur, au grand air.



► Tourner l'interrupteur de démarrage en position "ON"; l'instrumentation et les voyants exécutent le test de fonctionnement ; pendant cette phase, s'assurer de l'allumage de tous les voyants présents sur le tableau de bord.

► Afin que le système d'interruption du circuit d'allumage donne son accord pour le démarrage, une des conditions suivantes doit être observée:

- Le levier de vitesses est en position de point mort avec le levier de l'embrayage tiré.
- Le levier de vitesses est enclenché sur une vitesse avec le levier de l'embrayage tiré et la béquille latérale relevée.





► Si le test de fonctionnement détecte un défaut sur le véhicule, l'écran affiche le message d'avertissement figurant dans l'image. En particulier, l'affichage montre le dispositif de la moto sur laquelle le défaut a été détectée.



► Appuyer sur le bouton "OK" afin d'afficher la fonction "RUN".

**ATTENTION**

Si un défaut a été détectée, ne pas démarrer le moteur et contacter un centre d'assistance autorisé MV Agusta.





❑ Démarrage à froid

▶ Tourner le levier "CHOKE" sans tourner la poignée de l'accélérateur.

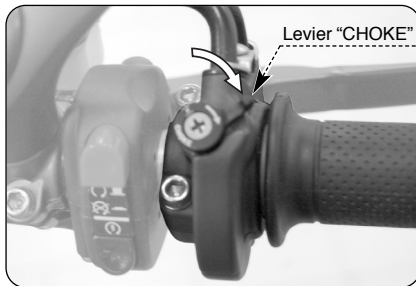

▶ Appuyer sur le bouton de démarrage du moteur.

▶ Dès que le moteur a démarré, relâcher le bouton et après l'avoir laissé chauffer un peu ramener le levier "CHOKE" dans sa position initiale.

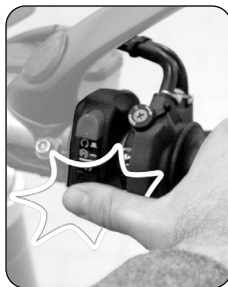



❑ Démarrage à chaud

- ▶ Appuyer sur le bouton de démarrage du moteur sans tourner la poignée de l'accélérateur.
- ▶ Dès que le moteur a démarré, relâcher le bouton.



Attention - précaution:

- Afin de ne pas endommager l'installation électrique, ne pas actionner le démarrage pendant plus de 5 secondes de suite.
- Ne pas faire fonctionner le moteur avec le véhicule à l'arrêt pendant trop longtemps. La surchauffe pourrait dans ce cas endommager les composants internes du moteur. Il est préférable d'amener le moteur à la bonne température en sélectionnant une vitesse réduite.
- Afin de prolonger au maximum la vie du moteur, ne pas accélérer à fond quand le moteur est froid.





4.4. Sélection et modification des fonctions à l'écran

L'instrumentation prévoit la possibilité d'intervenir sur certains des paramètres de mesure principaux.

Les opérations possibles sont:

- Sélection des modalités de fonctionnement:
 - “RUN” (Compteur kilométrique)
 - “CHRONO” (Chronomètre)
 - “SERVICE” (Échéance de l'entretien programmé)
 - “TC” (Contrôle de la traction)
 - “IMMOBILIZER” (Système antivol)
- Mise à zéro des fonctions des compteurs kilométriques partiels:
 - Compteur kilométrique Partiel 1 “TRIP 1”
 - Compteur kilométrique Partiel 2 “TRIP 2”
- Réglage des unités de mesure relatives à:
 - Vitesse
 - Distance parcourue
- Actionnement de la fonction chronomètre
- Sélection représentation de la centrale *

(*): Fonction présente uniquement sur certains modèles





4.4.1. Sélection des fonctions écran

La sélection concerne les modes de fonctionnement suivants:

- “RUN” (Compteur kilométrique)
- “CHRONO” (Chronomètre)
- “SERVICE” (Échéance de l’entretien programmé)
- “TC” (Contrôle de la traction)
- “IMMOBILIZER” (Système antivol)

L’affichage des différents modes de fonctionnement se fait en appuyant sur le bouton “SET” pendant une durée inférieure à quatre secondes. En appuyant sur ce bouton, les fonctions s’affichent à l’écran de façon cyclique. Sélectionner la fonction voulue.

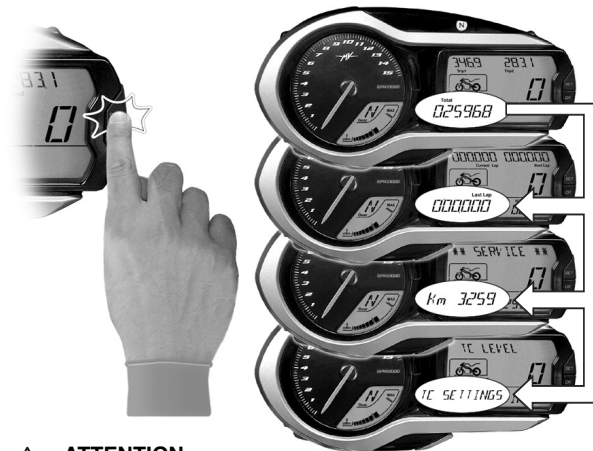

ATTENTION

Les opérations de modification ou de réglage des fonctions de l’écran doivent être effectuées avec le moteur coupé, le levier de vitesse au point mort, le véhicule arrêté et les pieds à terre. Il est interdit de changer les configurations de l’écran pendant la marche.



❑ Modalité “RUN”

Outre la fonction de compteur de vitesse, sur l'écran s'affichent les fonctions suivantes (voir §4.4.2.):

- Compteur kilométrique Total “TOTAL”
- Compteur kilométrique Partiel 1 “TRIP 1”
- Compteur kilométrique Partiel 2 “TRIP 2”

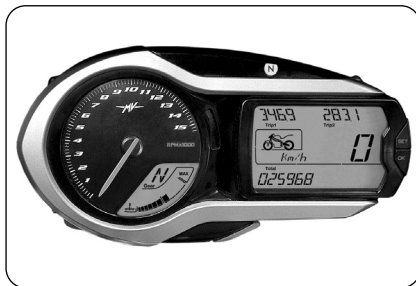

❑ Modalité “CHRONO”

Cette modalité permet l'actionnement de la fonction chronomètre et le stockage des données mesurées (voir §4.4.4.). Les fonctions affichées deviennent:

- Chronomètre Parcours actuel “CURRENT LAP”
- Chronomètre Parcours le plus rapide “BEST LAP”
- Chronomètre Parcours précédent “LAST LAP”
- Compteur de tours Nombre de tours parcourus “N° LAP”





❑ Modalité “SERVICE”

Ce mode de fonctionnement permet d'afficher l'intervalle kilométrique par rapport à l'échéance du prochain entretien programmé.

REMARQUE

Quand la distance kilométrique avant la prochaine révision est inférieure à 1000 km, la valeur apparaît automatiquement à la fin de la page de démarrage du véhicule.

❑ Modalité “TC”

Cette fonction permet d'adapter le niveau de contrôle de la traction du moteur selon vos propres exigences de conduite (voir §4.4.5.).

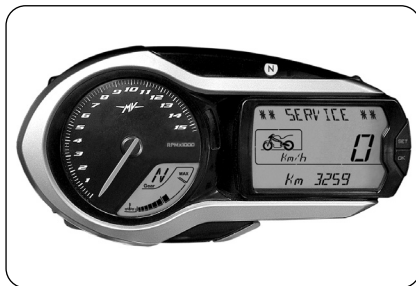
4^{LE}



❑ Modalité “IMMOBILIZER”

La fonction “IMMOBILIZER” ne permet le démarrage du moteur qu’après avoir reconnu la clé de démarrage originale. De fait, celle-ci représente un système antivol intégré dans le circuit électronique du véhicule, car elle empêche l’utilisation de ce dernier par toute autre personne. La modalité “IMMOBILIZER” du tableau de bord ne doit être utilisée qu’en cas de mal fonctionnement. En effet, si pour une raison quelconque la clé originale n’est pas reconnue par le système, il est nécessaire d’insérer manuellement le code secret reporté sur la MV Code Card pour obtenir l’autorisation au démarrage du moteur (voir §4.4.6.).





4.4.2. Mise à zéro des fonctions des compteurs kilométriques partiels

Les valeurs des fonctions “TRIP 1” et “TRIP 2” peuvent être mise à zéro de la façon suivante.



ATTENTION

Les opérations de modification ou de réglage des fonctions de l'écran doivent être effectuées avec le moteur coupé, le levier de vitesse au point mort, le véhicule arrêté et les pieds à terre. Il est interdit de changer les configurations de l'écran pendant la marche.

- ▶ Accéder à la modalité “RUN” et appuyer sur le bouton “SET” pendant plus de quatre secondes afin d'afficher “RUN MENU”.
- ▶ Appuyer sur le bouton “SET” pendant moins de quatre secondes afin d'afficher “TRIP 1 RESET”.

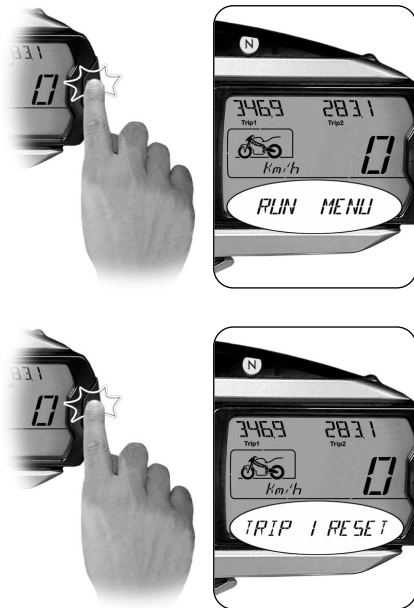



► Appuyer sur le bouton "OK" pendant plus de quatre secondes; la valeur "TRIP 1" commence à clignoter.



► Appuyer alors sur le bouton "OK" pendant moins de quatre secondes pour mettre la valeur à zéro. Par contre, en appuyant sur le bouton "SET" pendant plus de quatre secondes, la procédure de mise à zéro s'interrompt.

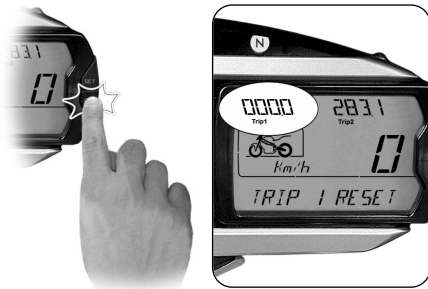



► Appuyer sur le bouton “SET” pendant moins de quatre secondes afin d’afficher “TRIP 2 RESET”.

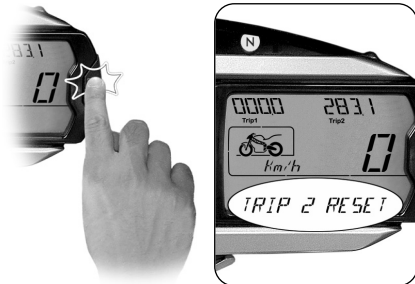

► Appuyer sur le bouton “OK” pendant plus de quatre secondes; la valeur “TRIP 2” commence à clignoter.



4



► Appuyer alors sur le bouton "OK" pendant moins de quatre secondes pour mettre la valeur à zéro. Par contre, en appuyant sur le bouton "SET" pendant plus de quatre secondes, la procédure de mise à zéro s'interrompt.

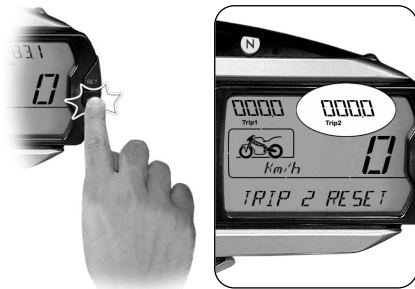

► Une autre pression sur le bouton "OK" permet de sortir de la modalité "TRIP 2 RESET" pour passer à la modalité suivante.

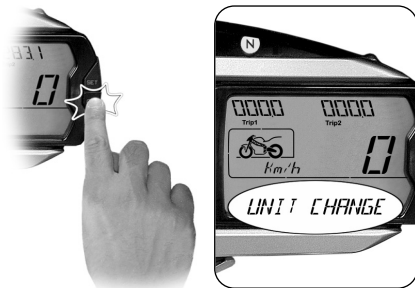



4.4.3. Réglage des unités de mesure

Il est possible d'effectuer en même temps la modification des unités de mesure suivantes:

- Vitesse
- Distance parcourue



ATTENTION

Les opérations de modification ou de réglage des fonctions de l'écran doivent être effectuées avec le moteur coupé, le levier de vitesse au point mort, le véhicule arrêté et les pieds à terre. Il est interdit de changer les configurations de l'écran pendant la marche.

- ▶ Accéder à la modalité "RUN" et appuyer plusieurs fois sur le bouton "SET" afin d'afficher "UNIT CHANGE".
- ▶ Appuyer sur le bouton "OK" pendant plus de quatre secondes; l'unité de mesure du compteur de vitesse commence à clignoter.

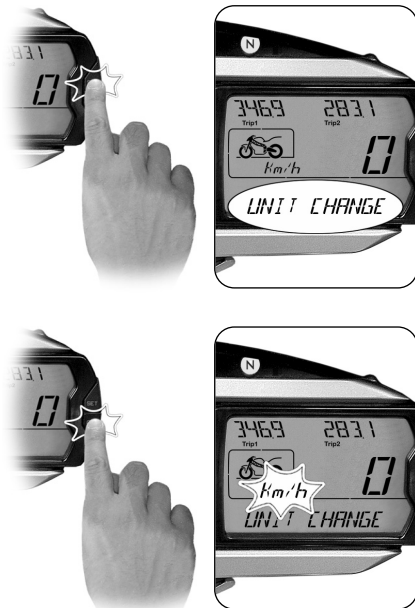



► Appuyer sur le bouton “OK” pour passer de Km/h à Mph ou vice versa. En changeant l’unité de mesure du compteur de vitesse, changent automatiquement également les unités suivantes:

- Compteur kilométrique (total et partiel): Km → mi

Par contre, en appuyant sur le bouton “SET” pendant plus de quatre secondes, la procédure de modification des unités de mesure s’interrompt.

► Appuyer sur le bouton “OK” pendant plus de quatre secondes; la nouvelle configuration des unités de mesure est confirmée.

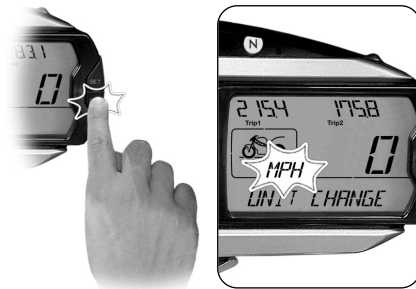

FR 4



4.4.4. Chronomètre

□ Acquisition des temps de parcours

► Après avoir actionné la fonction chronomètre (modalité "CHRONO") il est possible de lancer l'acquisition des données relatives aux temps de parcours.

► L'actionnement du bouton de clignotement du feu de route détermine le début de la mesure des données. Les points qui séparent les minutes des secondes et des dixièmes de seconde commencent à clignoter. L'instrument est en train d'acquérir les données.



4





► En appuyant à nouveau sur le bouton de clignotement du feu de route, la mesure du temps relatif au 1^{er} tour parcouru est enregistrée. En même temps, l'instrument commence à acquérir le temps relatif au second tour.

La mesure du temps relatif au premier tour est conservée en mémoire et reste affichée sur l'écran "LAST LAP" jusqu'à l'acquisition du tour suivant.

► En continuant à utiliser le chronomètre, un temps est enregistré à chaque actionnement du bouton de clignotement. L'instrument a la possibilité d'effectuer un nombre maximum de 100 enregistrements consécutifs.

Si le temps du dernier tour est inférieur aux temps mesurés pendant les tours précédents, l'indication sur l'écran "BEST LAP" est automatiquement mise à jour avec la nouvelle valeur.





□ Affichage des données

Une fois terminée la phase d'acquisition des temps, il est possible de les afficher.

► Accéder à la modalité "CHRONO" et appuyer sur le bouton "SET" pendant plus de quatre secondes afin d'afficher "CHRONO MENU".



ATTENTION

Les opérations de modification ou de réglage des fonctions de l'écran doivent être effectuées avec le moteur coupé, le levier de vitesse au point mort, le véhicule arrêté et les pieds à terre. Il est interdit de changer les configurations de l'écran pendant la marche.

► Appuyer sur le bouton "SET" pendant moins de quatre secondes afin d'afficher "LAPS VIEW".

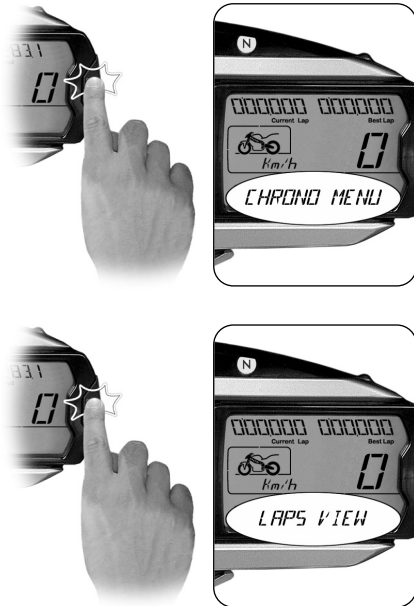



► En appuyant sur le bouton "OK", s'affichent le temps sur le tour le plus rapide ("BEST LAP") et le numéro du tour correspondant.

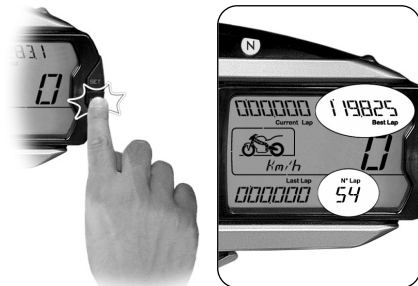

► Ensuite, plusieurs pressions sur le bouton de clignotement du feu de route permettent d'afficher en séquence tous les temps précédemment acquis à partir du 1^{er} tour.

► Une fois terminé l'affichage des données, la pression du bouton "SET" permet de sortir de la modalité "LAPS VIEW" pour passer à la modalité suivante.

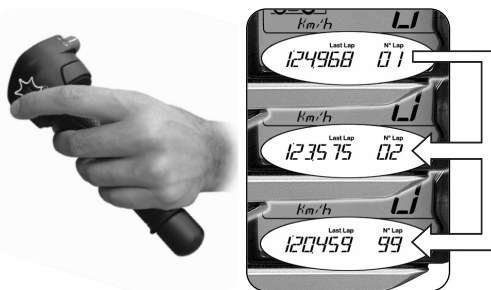



❑ Effacement des données

L'opération d'effacement des données enregistrées se fait en appliquant la procédure suivante:

► Accéder à la modalité "CHRONO" et appuyer sur le bouton "SET" pendant plus de quatre secondes afin d'afficher "CHRONO MENU".



ATTENTION

Les opérations de modification ou de réglage des fonctions de l'écran doivent être effectuées avec le moteur coupé, le levier de vitesse au point mort, le véhicule arrêté et les pieds à terre. Il est interdit de changer les configurations de l'écran pendant la marche.

► Appuyer plusieurs fois sur le bouton "SET" pendant moins de quatre secondes afin d'afficher "BEST LAP RESET".

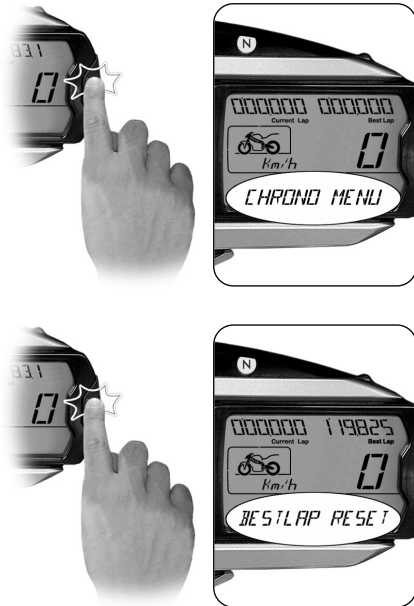



► Appuyer sur le bouton "OK" pendant plus de quatre secondes; la valeur "BEST LAP" commence à clignoter.



► Appuyer alors sur le bouton "OK" pendant moins de quatre secondes pour effacer la valeur. Par contre, en appuyant sur le bouton "SET" pendant plus de quatre secondes, la procédure d'effacement s'interrompt.

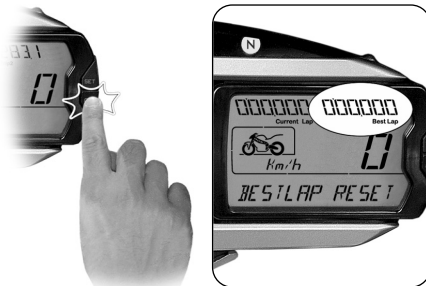

FR 4



► Appuyer sur le bouton “SET” pendant moins de quatre secondes afin d’afficher “LAPS RESET”.

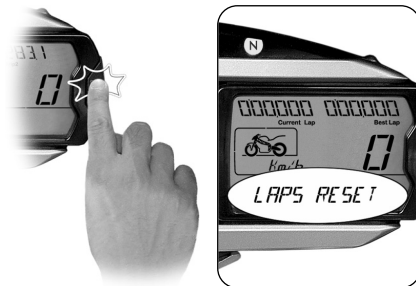

► Appuyer sur le bouton “OK” pendant plus de quatre secondes; la valeur “LAST LAP” commence à clignoter.

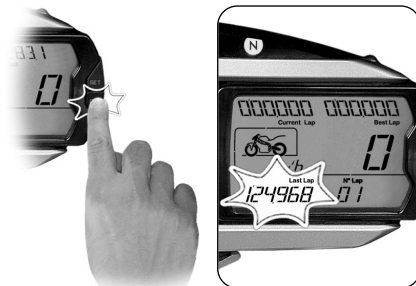



► En appuyant maintenant sur le bouton “OK” pendant moins de quatre secondes, tous les temps précédemment enregistrés sont effacés. Par contre, en appuyant sur le bouton “SET” pendant plus de quatre secondes, la procédure d’effacement s’interrompt.

FR 4

► Une pression ultérieure du bouton “OK” permet de sortir de la modalité “LAPS RESET” pour revenir à la fonction chronomètre.





4.4.5. Modalité "TC"

► Appuyer sur le bouton "SET" afin d'accéder à la modalité "TC", puis appuyer sur le bouton "SET" pendant plus de quatre secondes afin d'afficher "TC LEVEL". Le niveau actuel du contrôle de traction correspond à la valeur affichée à l'écran.



ATTENTION

Les opérations de modification ou de réglage des fonctions de l'écran doivent être effectuées avec le moteur coupé, le levier de vitesse au point mort, le véhicule arrêté et les pieds à terre. Il est interdit de changer les configurations de l'écran pendant la marche.

► En appuyant sur le bouton "OK" pendant moins de quatre secondes, le niveau du contrôle de traction augmente et passe à la valeur suivante. Cette valeur peut varier entre 0 et 8.

► Appuyer sur le bouton "OK" pendant plus de quatre secondes; la valeur choisie du niveau de contrôle de traction est confirmée.

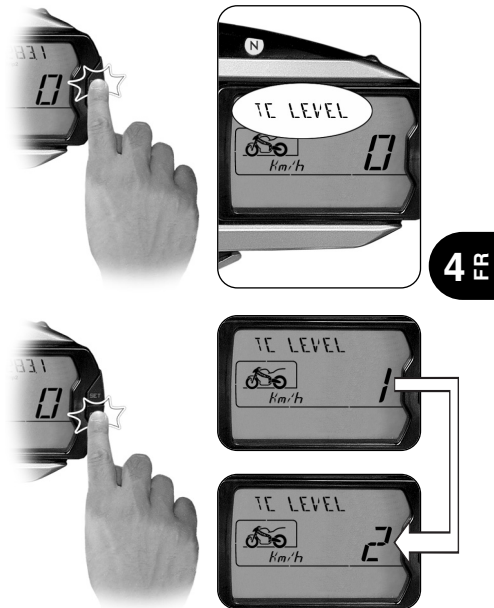



4.4.6. Modalité “IMMOBILIZER”

En cas de malfonctionnement, le système pourrait ne pas être en mesure de reconnaître le code de la clé de démarrage, empêchant ainsi au moteur de démarrer. Afin d'obtenir l'accord au démarrage du moteur, il est nécessaire d'insérer le code secret reporté sur la MV Code Card reçue au moment de la livraison du véhicule.

- ▶ Enlever le cache à l'arrière de la MV Code Card et lire le code secret électronique correspondant à la clé de démarrage (sur la figure est représenté un code au hasard, à titre indicatif).
- ▶ Accéder à la modalité “IMMOBILIZER” et appuyer sur le bouton “SET” pendant plus de quatre secondes afin d'afficher “INSERT CODE”.



ATTENTION

Les opérations de modification ou de réglage des fonctions de l'écran doivent être effectuées avec le moteur coupé, le levier de vitesse au point mort, le véhicule arrêté et les pieds à terre. Il est interdit de changer les configurations de l'écran pendant la marche.

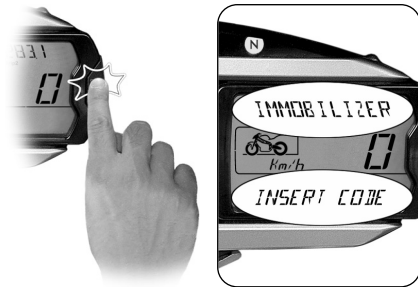



- ▶ Appuyer sur le bouton “SET” pendant moins de quatre secondes pour insérer le premier chiffre du code.
- ▶ La pression du bouton “OK” pendant moins de quatre secondes permet de varier entre 0 et 9 la valeur relative au premier chiffre.

- ▶ Une fois sélectionné le chiffre voulu, appuyer sur le bouton “OK” pendant plus de quatre secondes; le premier chiffre du code est confirmé. Il est alors possible d’insérer le deuxième chiffre du code.
- ▶ En procédant de manière analogue, il est possible de procéder à l’insertion des quatre chiffres restants.

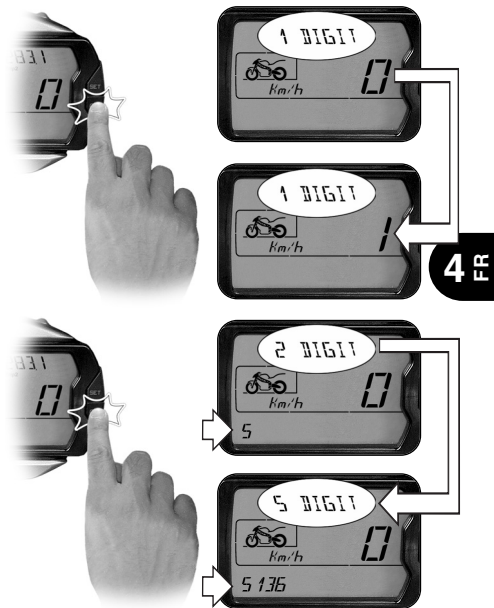



► Une fois complétée la procédure d'insertion du code, sur l'écran apparaît l'inscription "CONFIRM CODE". Appuyer sur le bouton "OK" pendant plus de quatre secondes pour confirmer le code inséré.

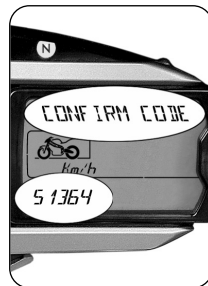

► Si le code inséré est correctement reconnu par le système, l'inscription "VALID CODE" s'affiche. L'écran du tableau de bord retourne en modalité "RUN". Il est possible de démarrer le moteur.

► Si le code inséré est incorrect, l'inscription "NOT VALID CODE" s'affiche. Le système ne donne pas l'accord au démarrage du moteur; l'écran retourne en modalité "INSERT CODE". Répéter la procédure d'insertion du code depuis le début, en faisant attention à bien insérer correctement les chiffres reportés sur la MV Code Card fournie. En cas de problèmes, contactez un centre d'assistance autorisé MV Agusta.

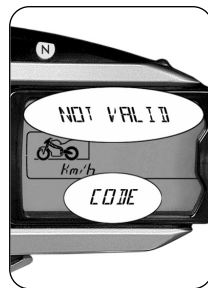
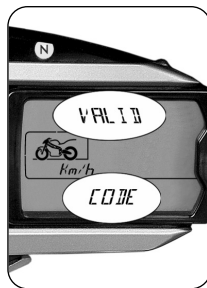



4.4.8. Sélection représentation de la centrale *

Sur certains modèles Brutale, il est possible de sélectionner une représentation spéciale de la centrale qui permet d'obtenir des caractéristiques élevées de puissance et de prestations pour un usage particulièrement sportif du véhicule.

La sélection du mappage de la centrale peut être effectuée en appuyant sur le bouton de démarrage lorsque le moteur est allumé. L'activation de la représentation "sport" est signalée à travers l'affichage de ce mot sur l'écran du tableau de bord.



ATTENTION

Les opérations de sélection de la représentation de la centrale doivent être effectuées avec le moteur allumé, le levier de vitesse au point mort, le véhicule arrêté et les pieds à terre. Il est interdit de changer les configurations de l'écran pendant la marche.

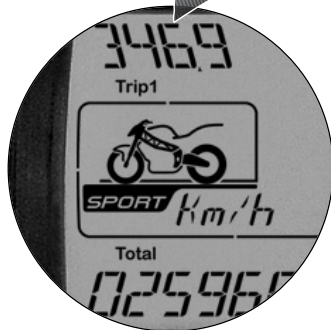

(*): Fonction présente uniquement sur certains modèles



4.4.8. Messages d'avertissement/pannes

Le tableau de bord peut signaler la présence d'une faute ou un dysfonctionnement au cours des différentes conditions d'utilisation de la moto.

► *Démarrage du moteur:* En tournant l'interrupteur de démarrage en position "ON"; l'instrumentation et les voyants exécutent le test de fonctionnement. Si le test de fonctionnement détecte un défaut sur le véhicule, l'écran affiche le message d'avertissement figurant dans l'image. En particulier, l'affichage montre le dispositif de la moto sur laquelle le défaut a été détectée.

► Appuyer sur le bouton "OK" afin d'afficher la fonction "RUN".



ATTENTION

Si un défaut a été détectée a moteur coupé, ne pas démarrer le moteur et contacter un centre d'assistance autorisé MV Agusta.





► *Marche du véhicule:* Si une anomalie est détectée pendant l'utilisation du véhicule, la partie inférieure de l'écran affiche le message d'avertissement figurant dans l'image.



ATTENTION

Si un défaut a été détectée pendant la marche, arrêter le véhicule et contacter un centre d'assistance autorisé MV Agusta.

► Après l'arrêt du véhicule, l'affichage montre le dispositif de la moto sur laquelle le défaut a été détectée.



4





► *Température élevée du liquide de refroidissement:*
Si une température élevée du fluide de refroidissement est détectée, l'écran affiche le message d'avertissement figurant dans l'image. Ce message peut apparaître lors de toutes les conditions d'utilisation du véhicule.

**ATTENTION**

En cas de température élevée, arrêter le véhicule et contrôler le niveau du liquide de refroidissement. Au cas où il serait nécessaire de remplir le réservoir, s'adresser à un centre d'assistance autorisé MV Agusta (voir § 3.8). Si l'indication apparaît et que le niveau est correct, ne pas redémarrer et contacter un centre d'assistance autorisé MV Agusta.





4.5. Approvisionnement en carburant



Danger - Attention: l'essence et ses vapeurs sont extrêmement inflammables et nocifs. Eviter le contact et l'inhalation. Pendant l'approvisionnement, couper le moteur, ne pas fumer, tenir à distance les flammes, étincelles et sources de chaleur. Effectuer l'approvisionnement à l'air libre ou dans un local suffisamment aéré.



Rappel - Précaution: utiliser exclusivement de l'essence super sans plomb avec un indice d'octane (R.O.N.) de 95 ou plus. Cette nécessité est rappelé par une pastille verte sur le côté inférieur du bouchon du réservoir.

- ▶ Soulever le cache poussière.
- ▶ Introduire la clé, tourner dans le sens des aiguilles d'une montre.

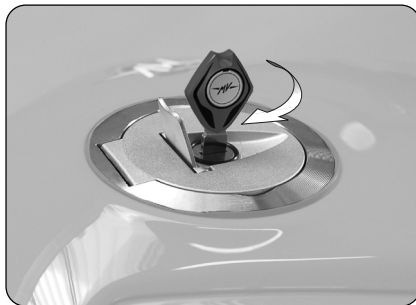
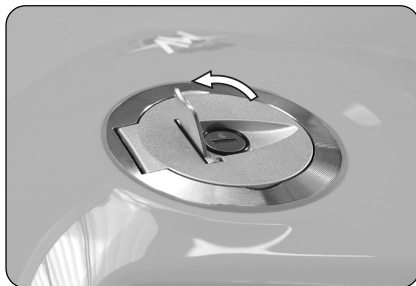
4
FR



► Soulever le couvercle et effectuer le ravitaillement en carburant.

 **ATTENTION: Un remplissage excessif du réservoir peut faire déborder le carburant à cause de l'expansion due à la chaleur du moteur ou à l'exposition de la moto à la lumière du soleil. Les écoulements éventuels de carburant peuvent provoquer des incendies. Le niveau de carburant dans le réservoir ne doit jamais dépasser la base de l'embout de remplissage.**

► Une fois l'approvisionnement effectué, pousser le bouchon vers le bas en tournant simultanément la clé dans le sens des aiguilles d'une montre pour faciliter la fermeture, puis relâcher la clé et l'extraire.

 **Rappel - Précaution: sécher immédiatement avec un chiffon propre le carburant éventuellement renversé, car il peut détériorer les peintures ou les plastiques.**

 **ATTENTION: Vérifier que le bouchon du réservoir à carburant est fermé correctement avant d'utiliser le véhicule.**





4.6. Accès à la boîte à gants

- ▶ Introduire la clé dans la serrure.
- ▶ Tourner la clé dans le sens des aiguilles d'une montre et simultanément appuyer légèrement sur la selle pilot. Soulever et extraire la selle.

Pour remonter l'élément, procéder de la façon suivante:

- Tourner la clé dans la serrure
- Presser la selle pilot
- Relâcher la clé
- Presser à nouveau la selle en s'assurant qu'elle est fermement accrochée à la structure.

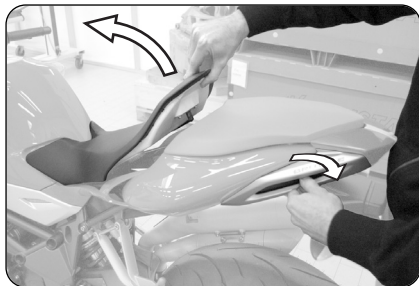

ATTENTION

Après avoir enlevé ou soulevé la selle pilot et en tout cas avant d'utiliser la moto, s'assurer que l'élément a été placé correctement et qu'il est fermement assujéti à la structure portante du véhicule.



4.7. Stationnement de la moto

□ Stationnement avec béquille latérale



ATTENTION: Garer la moto en conditions de sécurité et sur un terrain stable. Pour le stationnement en côte, garer la moto avec la roue avant en amont et la première vitesse engagée. Ne pas oublier de remettre le sélecteur de vitesses au point mort avant de redémarrer la moto. Ne pas laisser le véhicule sans surveillance avec la clé sur le contact. Lorsque le véhicule stationne sur la béquille latérale, il est dangereux de s'asseoir dessus

► Abaisser la béquille avec le pied jusqu'à la butée et incliner lentement la moto pour mettre le pied d'appui au contact du sol.

et de peser avec tout le poids du corps sur l'unique appui de stationnement. Avant de se mettre en route, vérifier le fonctionnement de l'interrupteur de sûreté en s'assurant que le voyant d'ouverture de la béquille latérale sur le tableau de bord s'éteint. Dans tous les cas, vérifier que la béquille est bien rentrée. En cas de fonctionnement défectueux, faire contrôler le dispositif par un concessionnaire MV Agusta avant d'utiliser la moto.





□ Stationnement avec la béquille arrière

Introduire l'axe de béquille dans l'orifice de l'axe de roue arrière du côté gauche de la moto. Appuyer la béquille au sol et en forçant dessus, soulever le véhicule jusqu'à ce qu'il se stabilise.



ATTENTION

Cette opération doit être effectuée par deux personnes.

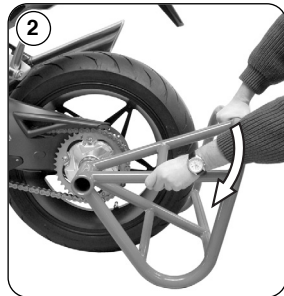
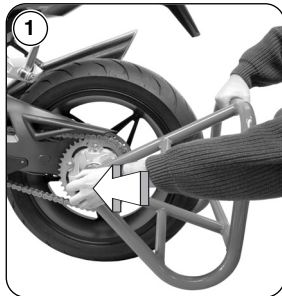



5.1. Liste des réglages

La moto dispose d'une grande diversité de réglages qui peuvent améliorer l'ergonomie, l'assiette et la sécurité.

Toutefois, étant donné qu'un réglage incorrect de pièces particulièrement importantes peut engendrer une situation de danger, quelques-uns des réglages sont réservés aux Centres d'Assistance MV Agusta.



ATTENTION

Tous les réglages s'effectuent à l'arrêt.



(E) Réglage du rétroviseur (§5.5.)

(F) Réglage de la suspension avant (§5.6.)

(A) Réglage du levier de frein avant (§5.3.)

(L) Orientation du phare (§5.8.)

(G) Réglage de la suspension
arrière (§5.7.)

(D) Réglage de la pédale
de frein arrière (§5.2.)

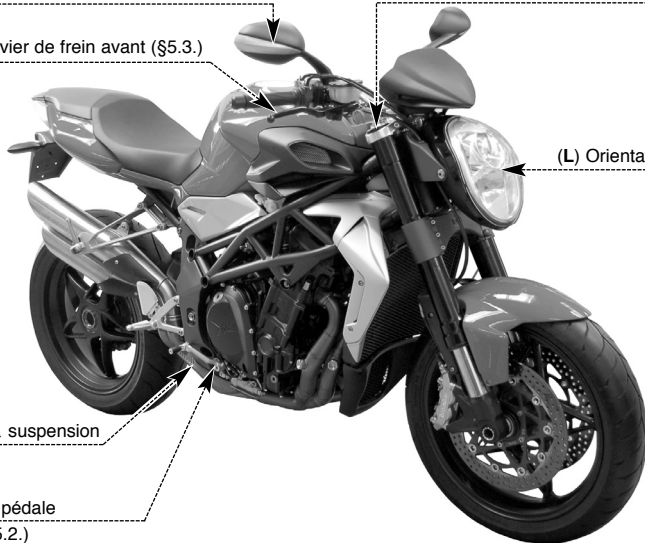



(E) Réglage du rétroviseur (§5.5.)

(F) Réglage de la suspension avant (§5.6)

(B) Réglage du levier
d'embrayage (§5.4.)

(C) Réglage du
sélecteur de vitesses
(§5.2.)

(H) Réglage de la chaîne (§5.2.)

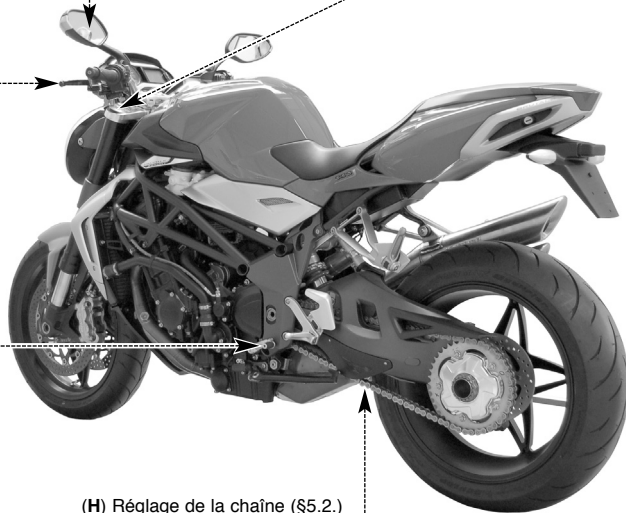



5.2. Tableau des réglages

	A - Réglage du levier de frein avant: pour améliorer la prise en fonction des nécessités du pilote (§5.3.).	F - Réglage de la suspension avant: pour adapter la réponse aux préférences du motard, on peut régler: <ul style="list-style-type: none">- la précharge du ressort (§5.6.1.)- le dispositif hydraulique de freinage en détente (§5.6.2.)- le dispositif hydraulique de freinage en compression (§5.6.3.)	
	B - Réglage du levier d'embrayage: pour améliorer la prise en fonction des nécessités du pilote (§5.4.).	G - Réglage de la suspension arrière: pour adapter la réponse aux préférences du motard, on peut régler: <ul style="list-style-type: none">- la précharge du ressort- la hauteur d'assiette	
	C - Réglage du sélecteur de vitesses: pour améliorer le mouvement de commande en fonction des nécessités du pilote.		<ul style="list-style-type: none">- le dispositif hydraulique de freinage en détente (§ 5.7.1).
	D - Réglage de la pédale de frein arrière: pour améliorer le mouvement de commande en fonction des nécessités du pilote.		H - Tension de la chaîne: pour l'efficacité et la fiabilité de la transmission.
	E - Réglage de l'amortisseur de direction: pour adapter la dureté de la direction aux préférences du pilote (§5.5). ATTENTION: Ne pas toucher la vis de fixation du rétroviseur au guidon. En cas de besoin, s'adresser à un concessionnaire MV AGUSTA.		L - Orientation du phare: pour optimiser la profondeur du faisceau lumineux en fonction de l'assiette (§5.8).



5.3. Réglage du levier de frein avant

Tirer le levier pour neutraliser la poussée du ressort et simultanément, régler la position en visant ou en dévissant l'écrou. En vissant: le levier s'éloigne de la poignée. En dévissant: le levier se rapproche de la poignée.

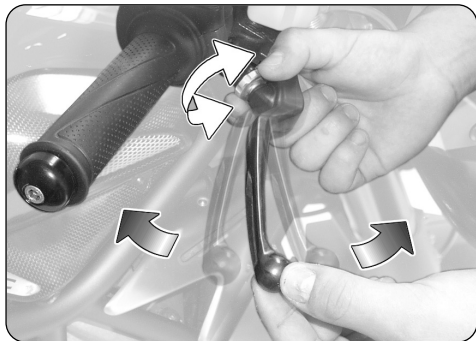

5.4. Réglage du levier d'embrayage

Tirer le levier pour neutraliser la poussée du ressort et simultanément, régler la position en visant ou en dévissant l'écrou. En vissant: le levier s'éloigne de la poignée. En dévissant: le levier se rapproche de la poignée.





5.5. Réglage des rétroviseurs

Pousser sur les points indiqués pour orienter le rétroviseur dans les quatre directions.

Régler les deux rétroviseurs. Pour une mise au point optimale, monter sur le véhicule pour réaliser le réglage.





5.6. Réglage de la suspension avant



NOTE

L'ajustement des suspensions doit être de préférence effectué avec le réservoir de carburant plein.



Dispositif hydraulique de freinage en détente

Précharge du ressort

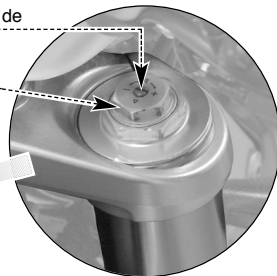

Dispositif hydraulique de freinage en compression

Précharge du ressort

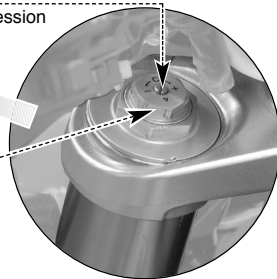



5.6.1. Précharge du ressort

Le réglage s'effectue en partant de la position standard. Pour trouver cette position, il faut dévisser à fond, puis visser jusqu'à la position standard (voir tableau annexe).

Visser pour augmenter la précharge du ressort ou dévisser pour la diminuer.



5.6.2. Dispositif hydraulique de freinage en détente (suspension avant)

Le réglage s'effectue en partant de la position standard. Pour trouver cette position, il faut visser à fond, puis dévisser jusqu'à la position standard (voir tableau annexe).

Visser pour augmenter l'action du freinage ou dévisser pour la diminuer.





5.6.3. Dispositif hydraulique de freinage en compression (suspension avant)

Le réglage s'effectue en partant de la position standard. Pour trouver cette position, il faut visser à fond, puis dévisser jusqu'à la position standard (voir tableau annexe).

Visser pour augmenter l'action du freinage ou dévisser pour la diminuer.





5.7. Réglage de la suspension arrière



ATTENTION: la haute température des tuyaux d'échappement peut provoquer des brûlures. Couper le moteur et attendre que les tuyaux d'échappement aient refroidi avant d'effectuer le réglage.

NOTE: L'ajustement des suspensions doit être de préférence effectué avec le réservoir de carburant plein.



Dispositif hydraulique de freinage en détente

5.7.1. Dispositif hydraulique de freinage en détente (suspension arrière)

Pour effectuer cette mise au point, agir sur la vis qui se trouve dans la partie inférieure de l'amortisseur en partant de la position standard.

Pour trouver cette position, il faut visser à fond, puis dévisser jusqu'à ce que vous entendez le premier clic; en suite, dévisser jusqu'à la position standard (voir tableau).

Visser pour augmenter l'action du freinage ou dévisser pour la diminuer.

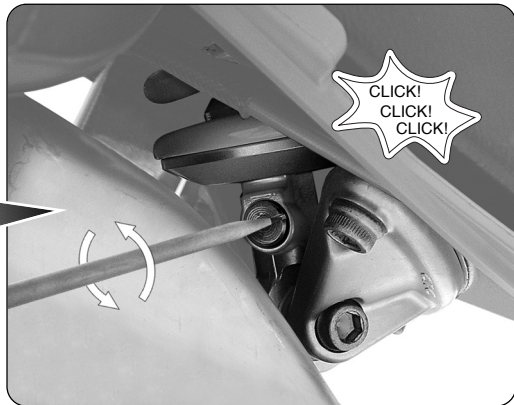



5.8. Réglage du projecteur avant

Placer le véhicule à 10 mètres d'une paroi verticale.

Veiller à ce que le terrain soit plat et l'axe du véhicule perpendiculaire à la paroi.

Le véhicule doit se trouver en position verticale. Mesurer la hauteur du centre du projecteur au sol et faire une croix sur la paroi à la même hauteur.

Allumer le code, la limite supérieure de démarcation entre la zone sombre et la zone éclairée ne doit pas dépasser $9/10$ de la hauteur au sol du centre du projecteur.

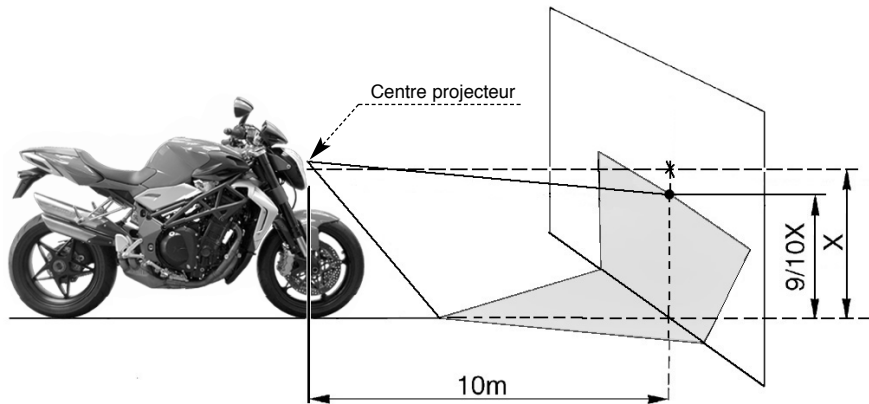



Pour la mise au point du phare antérieur, agir sur la vis représentée ci-contre. Dans le sens des aiguilles d'une montre: le phare s'incline vers le bas. Dans le sens contraire de celui des aiguilles d'une montre: le phare s'incline vers le haut. L'inclinaison peut varier de $\pm 4^\circ$ par rapport à la position standard.



FR 5



Note d'information

MV Agusta S.p.A. poursuit une politique de continuelle amélioration de ses produits. Pour cette raison, de légères différences pourraient éventuellement se présenter entre les informations de ce livret et le véhicule que vous avez acheté. Les modèles MV Agusta s'exportent dans de nombreux pays où des normes différentes sont en vigueur en ce qui concerne le Code de la Route et les procédures d'homologation. En espérant pouvoir compter sur votre compréhension, il est indispensable à MV Agusta S.p.A. de se réserver le droit d'apporter des modifications à ses produits et à la documentation technique à tout moment sans fournir de préavis.

Nous suggérons de visiter souvent le site Internet www.mvagusta.it afin d'obtenir des informations et des mises à jour sur les produits MV Agusta et la documentation relative.



Respectons et défendons l'environnement

Toutes nos actions ont des répercussions sur la planète entière et sur ses ressources. MV Agusta, au profit des intérêts de tous, sensibilise les Clients et les opérateurs du service après-vente pour leur faire adopter des modalités d'utilisation du véhicule et de traitement de ses parties dans le respect des normes en vigueur en terme de pollution, traitement et recyclage des déchets.

© 2010

Toute reproduction même partielle de ce document est formellement interdite sans autorisation écrite de MV Agusta S.p.A.

Dét. n° 8000B3247

Edition n° 1 - Juillet 2010



NOTES

FR 5

BRUTALE
990R

MV AGUSTA



Bedienungsanleitung
Deutsche Version

Sehr geehrter Kunde,

wir danken Ihnen für das Vertrauen, dass Sie uns ausgesprochen haben und gratulieren Ihnen zur Wahl Ihres neuen Brutale 990 R.

Dank dem beharrlichen Einsatz und Engagement seiner Techniker ist heute MV Agusta in der Lage seinen zahlreichen Fans ein innovatives und von einer Sonderverkleidung und raffinierter Radtechnologie charakterisiertes Produkt anzubieten: Elemente die alle mit dem MV Agusta Warenzeichen verzeichneten Erzeugnisse in der langen Zeitspanne seiner ruhmreichen Unternehmensgeschichte gekennzeichnet haben. Das Ergebnis ist ein exklusives Motorrad, das dank seinen ästhetischen und funktionellen Eigenschaften sowie den zahlreichen technischen Innovationen weit über den heutigen auf diesem Markt vertriebenen Qualitätsprodukten liegt.

Die angewandten Lösungen verleihen dem neuen Brutale 990 R einen unverwechselbaren Charakter, der dieses Motorrad zu den anderen Modellen der Familie MV Agusta anknüpft und die Projektphilosophie dieses Unternehmens, das der ständigen Forschung, und der technologischen Innovation besonders Wert schenkt und das winzigste Detail schätzen kann, konsolidiert. Jedem Motorradfahrer wird somit die Möglichkeit geschenkt, seine Leidenschaft in voller Freiheit zu genießen und zur gleichen Zeit ein Motorrad zu besitzen, das einzig auf der Welt ist und sich weltweit mit starkem Übergriff durchsetzt.

Falls Sie weitere Informationen wünschen, wenden Sie sich bitte an den Kundendienst der MV Agusta.

Viel Spaß!

*Claudio Castiglioni
Präsident
MV Agusta*



ALLGEMEINES INHALTSVERZEICHNIS

<i>Kap.</i>	<i>Inhalt</i>	<i>Seite</i>
1	ALLGEMEINE INFORMATIONEN	5
1.1.	Zweck der Bedienungsanleitung	5
1.2.	Zeichenerklärung	6
1.3.	Inhalt der Speichermedium	7
1.4.	Rahmen- und Motornummer	8
2	SICHERHEITSINFORMATIONEN	11
2.1.	Sachgemäßer Gebrauch des Fahrzeuges	11
2.2.	Wartung	11
2.3.	Zubehör und Änderungen	12
2.4.	Fahrzeugbeladung	12
3	BEDIENUNGSELEMENTE UND INSTRUMENTE	14
3.1.	Anbringung der Bedienelemente und Instrumente	14
3.2.	Seitlicher Ständer	16
3.3.	Bedienelemente links am Lenker	17
3.4.	Bedienelemente rechts am Lenker	19
3.5.	Zündschloß und Lenkerschloß	22
3.6.	Schaltung	26
3.7.	Instrumente und Kontrolllampen	27
3.7.1.	Kontrolllampen	28
3.7.2.	Multifunktionsdisplay/ Display eingelegerter Gang und Wassertemperatur	29
3.8.	Schmiermitteltabelle	30

<i>Kap.</i>	<i>Inhalt</i>	<i>Seite</i>
4	EINSATZ	31
4.1.	Einsatz des Motorrads	31
4.2.	Einfahren	32
4.3.	Starten des Motors	34
4.4.	Auswahl und Ändern der Display-Funktionen	38
4.4.1.	Auswahl der Display-Funktionen	39
4.4.2.	Nullstellen der Funktionen des Teilstrecken-Kilometerzählers	43
4.4.3.	Einstellung der Messeinheiten	47
4.4.4.	Chronometer/ Zeitmesser	49
4.4.5.	Betriebsmodus "TC"	57
4.4.6.	Betriebsmodus "IMMOBILIZER"	58
4.4.7.	Auswahl Mapping Zündelektronik	61
4.4.8.	Warnung / Störmeldung	62
4.5.	Tanken	65
4.6.	Zugang zum Staufach	67
4.7.	Parken des Motorrads	68
5	EINSTELLUNGSARBEITEN	70
5.1.	Liste der Einstellungsarbeiten	70
5.2.	Tabelle der Einstellungsarbeiten	73
5.3.	Einstellung Bremshebel Vorderradbremse	74
5.4.	Einstellung Kupplungshebel	74



ALLGEMEINES INHALTSVERZEICHNIS

<i>Kap.</i>	<i>Inhalt</i>	<i>Seite</i>
5.5.	Einstellung Rückspiegel	75
5.6.	Einstellung vordere Federung	76
5.6.1.	Federvorspannung	77
5.6.2.	Hydraulische Ausdehnungsbremse (Vorderradfederung)	77
5.6.3.	Hydraulische Kompressionsbremse (Vorderradfederung)	78
5.7.	Einstellung hintere Federung	79
5.7.1.	Hydraulische Ausdehnungsbremse (Hinterradfederung)	80
5.8.	Scheinwerfereinstellung	81



1.1. Zweck der Bedienungsanleitung

Dieses Handbuch enthält alle für einen korrekten und sicheren Gebrauch Ihres Motorrads erforderlichen Informationen.

Zusammen mit dem Handbuch erhalten Sie auch ein Quick Manual im Taschenformat mit den wichtigsten gebrauchrelevanten Informationen.

Das Handbuch wird in elektronischem Format (.pdf) auf dieser Speichermedium geliefert und kann auf jedem PC mit Windows oder Mac eingesehen oder ausgedruckt werden.

Wir bitten Sie, dieses Handbuch vor der ersten Benutzung des Motorrads aufmerksam durchzulesen und sich immer zu vergewissern, dass auch andere Personen, die das Motorrad benutzen, dies tun.

Vergessen Sie bitte nicht, in das Quick Manual Ihre Daten und die Daten Ihres Motorrads einzutragen und es immer mitzuführen.



Copyright
MV AGUSTA Motor Spa
Alle Rechte vorbehalten



1.2. Zeichenerklärung

Besonders wichtige Textstellen die sich auf die Sicherheit der Personen oder des Fahrzeugs beziehen, sind mit folgenden Symbolen gekennzeichnet:



Gefahr - Achtung: Die mangelnde oder unvollständige Beachtung dieser Vorschriften stellt eine schwere Unfallgefahr für den Arbeiter oder Dritte dar.



Vorsicht - Vorsichtsmaßnahme: Die Nichteinhaltung der Anweisungen kann schwere und dauerhafte Schäden am Fahrzeug verursachen.

Folgende Symbole werden benutzt, um anzuzeigen, wer die angegebenen Wartungs- und Einstellungsarbeiten ausführen darf:



Informationen zu Arbeiten, die vom Motorradfahrer ausgeführt werden dürfen.



Informationen zu arbeiten, die ausschließlich von ausgebildetem Fachpersonal ausgeführt werden dürfen.

Um weitere Informationen hervorzuheben, werden folgende Symbole verwendet:



Das Symbol zeigt an, dass für die richtige Durchführung der angegebenen Arbeit ein Spezialwerkzeug oder Sonderausrüstung benötigt werden.



Das Zeichen “§” gefolgt von einer Ziffer verweist auf das entsprechende Kapitel.



1.3. Inhalt der speichrmedium

Auf dieser speichermedium finden Sie außer diesem Handbuch auch das Wartungshandbuch, das Quick Manual (das Sie auch als Büchlein erhalten haben), die Händlerliste, die Garantie-Heft und die Kataloge der speziellen Teilen MV Agusta.

Bei der Übergabe des Motorrades hat Ihnen Ihr Händler auch das Garantiebescheinigung ausgehändigt.

Bewahren Sie es bitte sorgfältig zusammen mit den Fahrzeugpapieren und den zukünftigen Bescheinigungen auf, die Sie bei jeder Inspektion ausgehändigt bekommen werden.

WICHTIG

Eine Kopie der Garantiebescheinigung muß vom Vertragshändler ausgefüllt und innerhalb von 10 Tagen nach Zulassung an die MV Agusta geschickt werden.

Die Wartungscoupons müssen nach Abschluss der jeweiligen Wartungsarbeiten ebenfalls innerhalb von 10 Tagen vom Vertragshändler ausgefüllt und an die MV Agusta geschickt werden.



1.4. Rahmen- und Motornummer

- 1) Rahmennummer
- 2) Motornummer
- 3) Zulassungsnummer

► Kennzeichnung des Motorrads

Das Motorrad wird durch die Rahmennummer eindeutig gekennzeichnet. Bei Ersatzteilbestellungen müssen die Rahmennummer und gegebenenfalls auch die Motornummer, die Farbkennziffer und die Schlüsselnummer angegeben werden.

Wir empfehlen Ihnen die wichtigsten Angaben nachstehend einzutragen.

RAHMENNUMMER: _____

MOTORNUMMER: _____



► Schlüsselnummer

Sie erhalten einen Schlüssel und einen Ersatzschlüssel. Die Schlüssel dienen als Zündschlüssel und zum Öffnen aller Schlösser. Den Ersatzschlüssel an einem sicheren Ort aufbewahren.

Bei Nachfrage eines Duplikates ist die Kenntnis der Identifikationsnummer des Schlüssels grundlegend. Die Schlüssel-Identifizierungsnummer ist auf der MV Code Card angegeben, die zusammen mit den Zündschlüsseln geliefert wird.

► Farbkennziffer

Die Farbkennziffer wird bei Bestellung von Karosserieteilen benötigt. Sie befindet sich auf dem rechten unteren Seite des Benzintanks.

Um das Farbkennzifferschild zu lesen, ist es notwendig das rechte seitliche Tankteil zu lösen. Ziehen Sie die Rückseite der rechten seitlichen Tankteil aus, wie in der Abbildung gezeigt.



1 DE

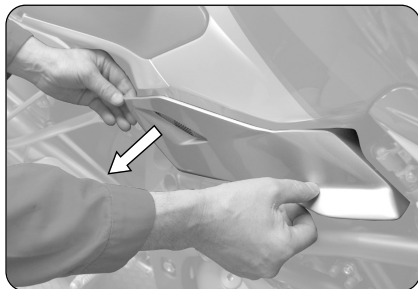



DE 1

Entfernen Sie die rechte seitliche Tankteile, indem Sie sie zur Rückseite des Motorrads ziehen.

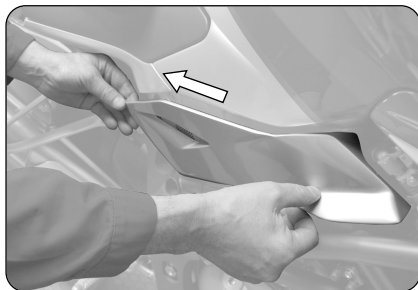

Nach Tankteilbeseitigung, ist es möglich, das Farbkennzifferschild zu sehen. Auf dem Schild ist die jeweilige Farbekennziffer des Motorrads zur Lackierung der Karosserieteile angegeben.

Es wird geraten, die Farbkennziffer des Motorrads im nachfolgenden Leerraum einzutragen:

FARBKENNZIFFER:

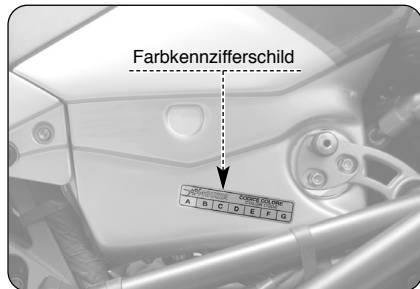



2.1. SACHGEMÄSSER GEBRAUCH DES FAHRZEUGES

Ihr Motorrad wurde ausschließlich für die Benutzung auf Straßen und Autobahnen geplant.



ACHTUNG

Ausnahmeweise können Sie Ihr Motorrad auch auf einer Rennstrecke benutzen – allerdings nicht, um Rennen zu fahren.

Dabei ist das Motorrad jedoch sehr hohen Beanspruchungen ausgesetzt und daher sollte es vorher und nachher in einer MV Agusta-Vertragswerkstatt überprüft werden.

Jeder andere Einsatz ist ausdrücklich ausgeschlossen und strengstens untersagt.

Weitere Informationen zur Benutzung des Motorrades finden Sie im Abschnitt 4 dieses Handbuches.

2.2. WARTUNG

Damit Ihr Motorrad stets einwandfrei und zuverlässig funktioniert, müssen Sie die im Wartungshandbuch vorgesehenen Inspektionstermine unbedingt einhalten.

Sie sollten diese ausschließlich von Fachleuten in einer MV Agusta-Vertragswerkstatt durchführen lassen.

Sollten Sie sich hingegen für eine freie Werkstatt entscheiden, müssen Sie sich von dieser bestätigen lassen, dass sie über alle für die Durchführung der erforderlichen Kontrollen und Einstellungen notwendigen Ausrüstungen, Möglichkeiten und Kenntnisse verfügt.



ACHTUNG

Die Garantie von MV Agusta könnte im Fall von in freien Werkstätten ausgeführten Eingriffen an Ihrem Motorrad, die nicht den technischen Rundschreiben und den MV Agusta-Werkstatthandbüchern entsprechen, verfallen.



2.3. ZUBEHÖR UND ÄNDERUNGEN



ACHTUNG

Der Hersteller untersagt jegliche eigenmächtige Änderung an seinen Fahrzeugen.

Nur so kann die Sicherheit der Benutzer gewährleistet werden.

Allerdings besteht die Möglichkeit, Ihr Motorrad anhand des umfangreichen MV Agusta-Zubehörkatalogs zu personalisieren.



ACHTUNG

Durch die Installation einiger dieser Zubehörteile kann die Zulassung des Motorrades jedoch ungültig werden, was bedeutet, dass Sie damit nicht mehr auf öffentlichen Straßen fahren dürfen.

Wenden Sie sich daher im Zweifelsfall an Ihren Vertragshändler MV Agusta, bevor Sie entscheiden, welches Zubehör für Ihre Erfordernisse geeignet ist.

2.4. FAHRZEUGBELADUNG

Das Motorrad wurde zum Einsatz des Fahrers und höchstens eines Beifahrers entworfen.

Für einen sicheren Einsatz und unter Berücksichtigung der Straßenverkehrsvorschriften müssen die technische Gewichtswert, die hier unten angegeben ist, nie überschritten werden:

BRUTALE 990 R

Maximales Gesamtgewicht **370 kg**

Maximallastgewicht **180 kg**

Das maximale Gesamtgewicht ist die Summe der folgenden Gewichte, gemäß der Richtlinien CEE 92/61:

- Motorradgewicht;
- Fahrergewicht;
- Beifahrgewicht;
- Ladegewicht und das der Zubehörteile.

**ACHTUNG**

Da das Gewicht einen enormen Einfluss auf die Lenkbarkeit, die Bremsleistung, die Fahrzeugeigenschaften und die Fahrzeugsicherheit hat, müssen die folgenden Vorschriften stets eingehalten werden.

- **DAS MOTORRAD NIE ÜBERLADEN!**
Ein überladenes Motorrad kann die Reifen beschädigen, zu einem Kontrollverlust und schweren Unfällen führen. Überprüfen, dass das Gesamtgewicht mit Fahrer, Beifahrer, Gepäck und Zubehör das zulässige Fahrzeug-Gesamtgewicht nicht überschreitet.



3.1. Anbringung der Bedienelemente und Instrumente

DE 3

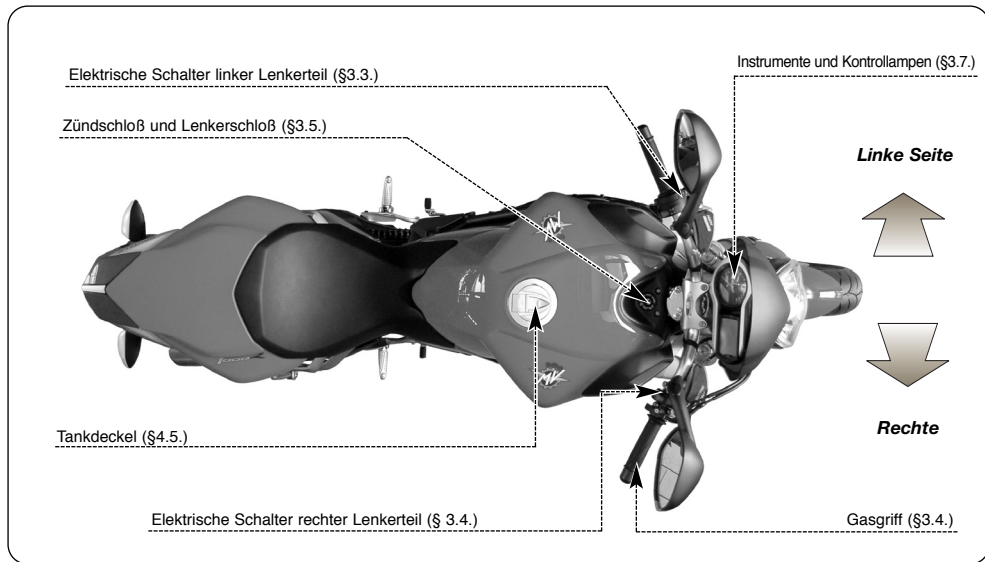



BEDIENUNGSELEMENTE UND INSTRUMENTE 3

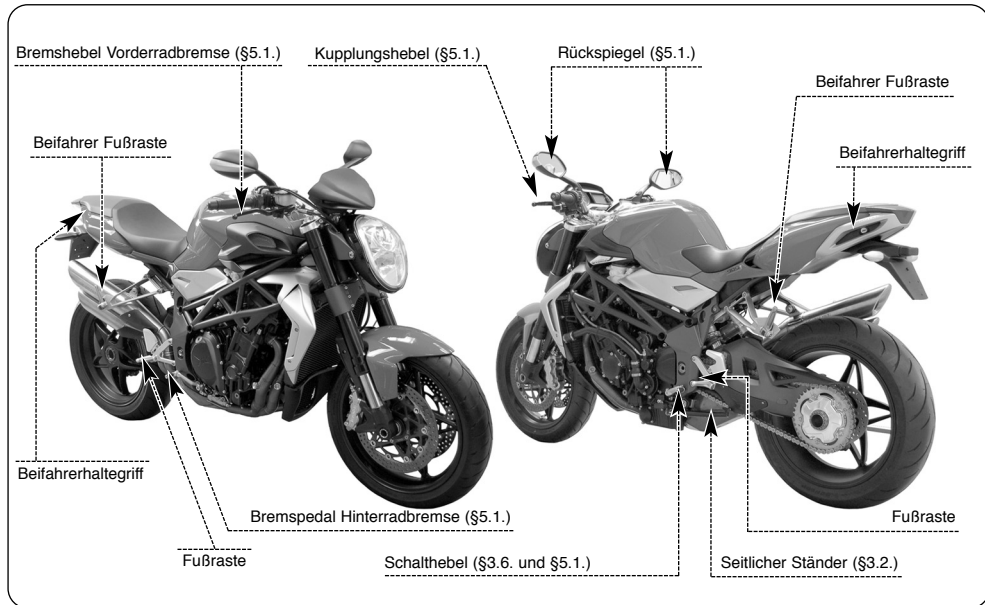

3
DE



3.2. Seitlicher Ständer

Der Seitenständer ist mit einem Sicherheitsschalter (Startfreigabe) ausgerüstet, der ein Losfahren bei runtergeklapptem Seitenständer verhindert.

Ist der Motor bei runtergeklapptem Seitenständer angelassen worden und wird der Kupplungshebel gezogen, um zu Losfahren einen Gang einzulegen, wird die Stromversorgung zum Motor unterbrochen und der Motor stellt sich ab.

Ist der Seitenständer runtergeklappt und gleichzeitig ein Gang eingelegt, verhindert der Schutzschalter, dass der Motor gestartet werden kann. Auf diese Weise wird ein Umfallen des Motorrads vermieden.

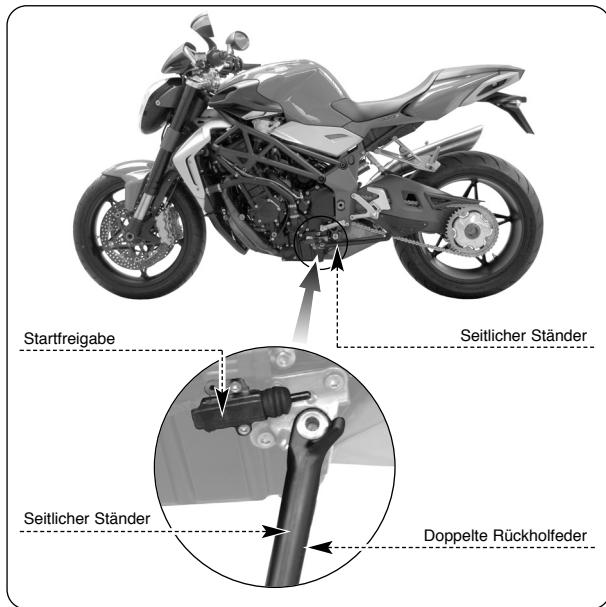



3.3. Linke Lenkerschalter

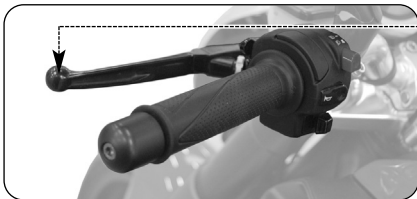

Kupplungshebel

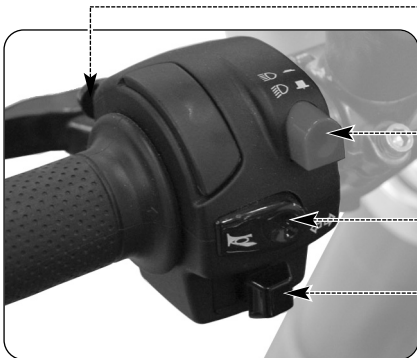

Zur Betätigung der Kupplung den Kupplungshebel ziehen und wieder loslassen.



Druckschalter Lichtupe

Den Schalter mehrmals drücken.

Druckschalter Fernlicht/Fahrlicht

Druckschalter hoch: ■ Fahrlicht 
Druckschalter tief: — Fernlicht 

Hupenschalter

Zur Betätigung der Hupe den Schalter drücken.

Blinkerschalter

Bei Verstellen des Hebels nach rechts oder links werden jeweils die rechten oder linken Blinker eingeschaltet. Der Hebel stellt sich auf Mittelstellung zurück. Zum Ausschalten der Blinker auf den Hebel drücke



Lichthupenschalter

Die Betätigung der Lichthupe durch den Lichthupenschalter dient dazu andere Verkehrsteilnehmer auf sich aufmerksam zu machen oder Gefahren zu signalisieren. Bei eingeschaltetem Fernlicht funktioniert die Lichthupe nicht.

Druckschalter Fernlicht/ Ablendlicht

Schaltet sich normalerweise das Ablendlicht ein. Wenn es der Verkehr und die Straßenführung zulassen, kann mit diesem Druckschalter auf Fernlicht umgeschaltet werden.

Blinkerschalter

Mit diesem Schalter kann anderen Verkehrsteilnehmern ein Fahrtrichtungs- oder Spurwechsel angezeigt werden.



ACHTUNG

Das Nichtbetätigen oder die falsche Betätigung/ das Nichtausschalten des Blinkerschalters kann Unfälle verursachen. Die anderen Verkehrsteilnehmer können dadurch falsche Rückschlüsse auf die tatsächliche Fahrtrichtung ziehen. Vorm Abbiegen oder Spurwechsel stets die Blinker betätigen.

Hupenschalter

Die Betätigung der Hupe durch den Hupenschalter dient dazu andere Verkehrsteilnehmer auf sich aufmerksam zu machen oder Gefahren zu signalisieren.

Kupplungshebel

Mit diesem Hebel wird die Kupplung über eine hydraulische Vorrichtung ein- und ausgekuppelt.



3.4. Rechte Lenkerschalter

Bremshebel Vorderradbremse

Zum Bremsen mit der Vorderradbremse den Bremshebel ziehen.

Gasgriff

Zum Gasgeben den Griff drehen.

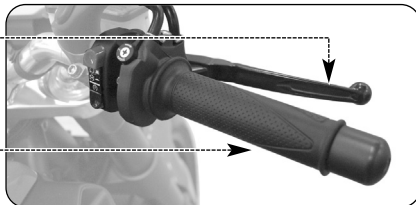

Chokehebel (Kaltstart)

Bei Kaltstart des Motors in Uhrzeigersinn drehen. Nach einigen Sekunden den Hebel in Ausgangsstellung zurückstellen.

Schalter zum Abstellen des Motors

Bei Betätigung wird der Motor abgestellt und kann nicht gestartet werden.

Druckschalter zum Anlassen des Motors

Bei Betätigung wird der Motor gestartet. Sobald der Motor läuft muß der Schalter losgelassen werden. Wird der Schalter bei laufendem Motor erneut betätigt, können die Display-Funktionen ausgewählt werden.

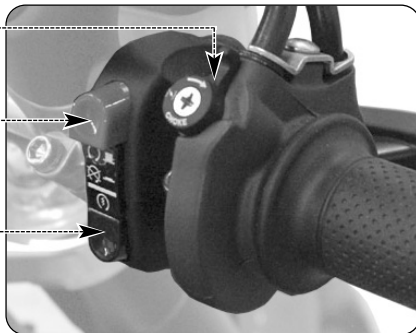



Schalter zum Abstellen des Motors

Mit diesem Schalter kann der Motor in Notfällen abgestellt werden. Wird dieser Schalter betätigt, wird der Zündkreislauf unterbrochen, der Motor kann nicht gestartet werden. Soll der Motor neu gestartet werden, muss vorher dieser Schalter in Ausgangsstellung zurückgestellt werden.

ANMERKUNG

Unter normalen Bedingungen wird dieser Schalter nie zum Abstellen des Motors verwendet.

Druckschalter zum Anlassen des Motors

Mit diesem Schalter wird der Motor gestartet. Bei laufendem Motor können über diesen Schalter die einzelnen Display-Funktionen ausgewählt werden.



VORSICHT

Um Schäden an der elektrischen Anlage zu vermeiden, sollte dieser Schalter bei Startversuchen nie länger als 5 Sekunden gedrückt werden.

Sprint der Motor nach einigen Startversuchen nicht an, siehe Kapitel "STÖRUNGEN" in der vorliegenden Bedienungsanleitung.

Chokehebel (Kaltstart)

Mit dieser Vorrichtung wird der Kaltstart des Motors vereinfacht.

ANMERKUNG

Der Chokehebel sollte nur kurze Zeit und bei der entsprechenden Motor- und Außentemperatur gezogen werden. Reicht die Motordrehzahl aus, um den Motor im Leerlauf laufen zu lassen, sollte der Chokehebel zurückgestellt werden.



Gasgriff

Mit dem Gasgriff wird die Benzinversorgung des Motors geregelt. Zum Gasgeben den Gasgriff aus Ruhestellung (Leerlaufstellung) drehen.

Wird nach einem Kaltstart des Motors (eingeschalteter Choke) der Gasgriff wiederholt in Ruhestellung zurückgedreht, wird der Chokehebel in Ausgangsstellung zurückgestellt.

Bremshebel der Vorderradbremse

Diese Steuerung ermöglicht die Einschaltung des Vorderrad-Bremssystems durch einen hydraulischen Kreislauf.



3.5. Zündschloß und Lenkerschloß

 **ACHTUNG:** Keine Schlüsselanhänger oder anderes am Zündschlüssel anbringen, damit die Lenkerdrehung nicht eingeschränkt wird.

 **ACHTUNG:** Den Zündschlüssel niemals während der Fahrt drehen, Sie könnten sonst die Kontrolle über das Fahrzeug verlieren.

DE 3

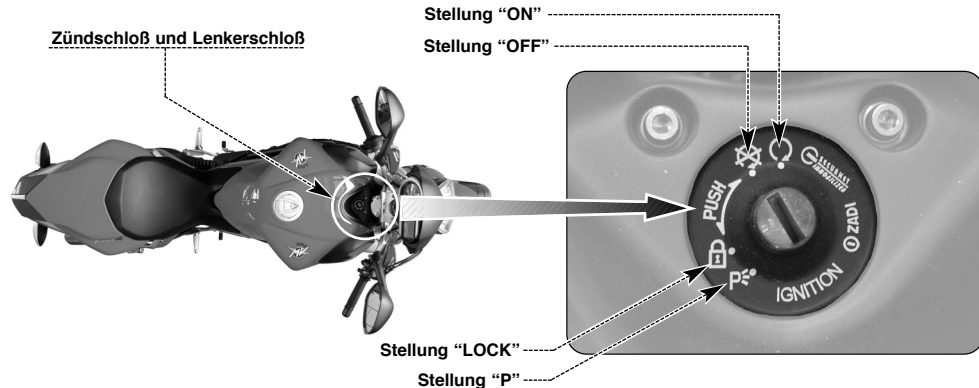



Über das Zündschloß werden der elektrische Kreislauf und das Lenkerschloß ein- bzw. ausgeschaltet. Es gibt folgende vier Stellungen für den Zündschlüssel.

Stellung "OFF"

Alle elektrischen Stromkreise sind ausgeschaltet, der Zündschlüssel kann abgezogen werden.



Stellung "ON"

Alle elektrischen Stromkreise sind eingeschaltet, die Instrumente und Kontrolllampen führen eine Autodiagnose durch, der Motor kann gestartet werden. Der Zündschlüssel kann nicht abgezogen werden.



3 DE



Vorsicht - Vorsichtsmaßnahme: Die Nichteinhaltung der Anweisungen kann schwere und dauerhafte Schäden am Fahrzeug verursachen.



Stellung "LOCK"

Den Lenker nach rechts oder links drehen. Den Schlüssel leicht drücken und auf Stellung "LOCK" drehen. Alle elektrischen Stromkreise sind ausgeschaltet, das Lenkerschloß ist eingesteckt, der Zündschlüssel kann abgezogen werden.

DE 3

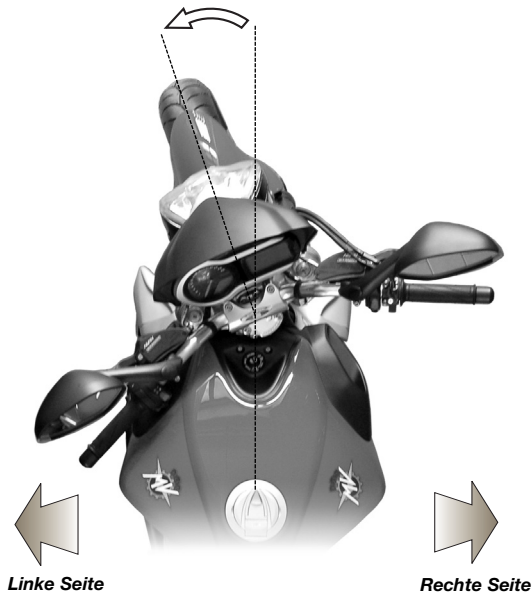



Stellung "P"

Den Schlüssel von Stellung "LOCK" auf Stellung "P" drehen. Alle elektrischen Stromkreise sind mit Ausnahme des Parklichts (Standlichts) ausgeschaltet, das Lenkerschloß ist eingerastet. Der Zündschlüssel kann abgezogen werden.



VORSICHT

Um ein Entladen der Motorradbatterie zu vermeiden, den Schlüssel nicht längere Zeit in Stellung "P" lassen.





3.6. Schaltung

Die Stellung **N** "Neutral" ist die Leerlaufstellung, die auch durch Aufleuchten der entsprechenden Kontrolllampe am Armaturenbrett angezeigt wird.

Durch Drücken nach unten wird der erste Gang eingelegt.

Durch Drücken nach oben wird der zweite Gang, durch weiteres Drücken der dritte Gang usw. bis zum sechsten Gang eingelegt.

DE 3



Schalthebel

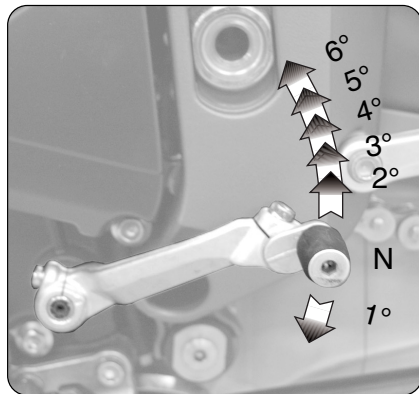



3.7. Instrumente und Kontrolllampen

Die Instrumente und die Kontrolllampen schalten sich ein, wenn der Zündschlüssel auf "ON" gedreht wird. Nach einer Anfangskontrolle (ungefähr 7 Sekunden) entsprechen die Informationen dem allgemeinen Ist-Zustand des Motorrads.

Kontrolllampen
(§3.7.1.)

Drehzahlmesser

Display eingelegter
Gang und
Wassertemperatur
(§3.7.2.)

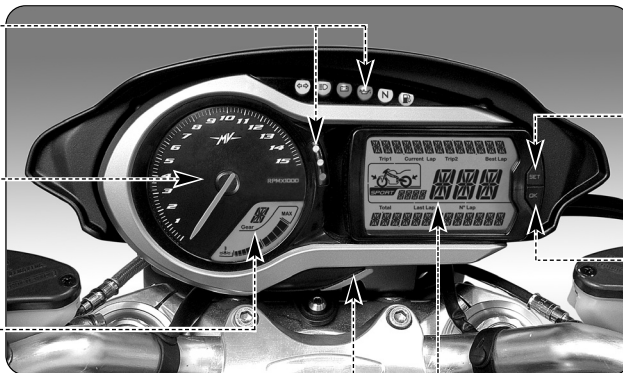

Taste "SET"
(§3.7.2.)

Taste "OK"
(§3.7.2.)

Taste "WARNBLINKANLAGE" (§3.7.2.)

Multifunktions-Display (§3.7.2.)



3.7.1. Kontrolllampen

Fernlichtkontrolle (blau)

Leuchtet auf, wenn das Fernlicht eingeschaltet ist.

Motoröldruckkontrolle (rot)

Leuchtet auf, wenn der Öldruck unzureichend ist.

DE 3

Blinkerkontrolle (grün)

Leuchtet auf, wenn die Blinker eingeschaltet sind.

Kontrollleuchte

Drehzahlbegrenzer (rot)

Leuchtet auf, wenn die Motordrehzahl 11600 U/Min überschreitet.

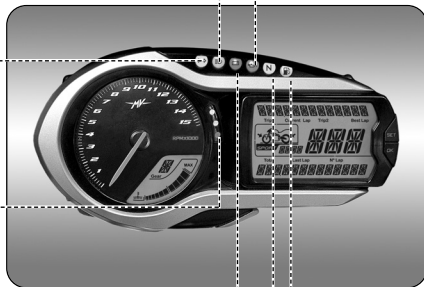

Batterie-Ladekontrolle (rot)

Leuchtet auf, wenn die Lichtmaschine nicht ausreichend Strom zum Laden der Batterie liefert. Schaltet sie sich während der Fahrt ein, wenden Sie sich bitte an einen autorisierten Kundendienst.



Gefahr – Achtung: Schaltet sie sich während der Fahrt ein, sofort anhalten und den Ölstand kontrollieren. Gegebenenfalls bei einem autorisierten MV Agusta Kundendienst nachfüllen lassen (siehe §3.8). Schaltet sie sich auch bei richtigem Ölstand ein, nicht weiterfahren und einen autorisierten MV Agusta Kundendienst benachrichtigen.

Benzinreservekontrolle (orange)

Leuchtet auf, wenn im Tank noch ungefähr 4 Liter Kraftstoff enthalten sind.

Kontrolllampe Schaltung in Leerlauf (grün)

Leuchtet auf, wenn die Schaltung auf Leerlaufposition "Neutral" gestellt ist.



3.7.2. Multifunktionsdisplay/ Display eingelegter Gang und Wassertemperatur

Display eingelegter Gang

Zeigt an, welcher Gang aktuell eingelegt ist. Die Leerlaufposition wird durch den Buchstaben "N" (Neutral) angezeigt.

Thermometer

Zeigt die Kühlflüssigkeitstemperatur durch Einschalten unterschiedlich vieler Balken an einer Messskala an. Liegt die Temperatur außerhalb des normalen Betriebsbereiches, kann folgendes angezeigt werden: - Am Display wird nur ein einziger, blinkender Balken angezeigt. Das ist die Anzeige für niedrige Temperatur. - Alle Balken sind eingeschaltet, der oberste Balken blinkt. Das ist die Anzeige für hohe Temperatur.



Gefahr – Achtung: Bei hoher Temperatur das Fahrzeug anhalten und den Kühlflüssigkeitsstand kontrollieren. Muss nachgefüllt werden, wenden Sie sich bitte an einen autorisierten MV Agusta Kundendienst (siehe § 3.8). Erscheint die Anzeige auch bei richtigem Kühlflüssigkeitsstand, nicht weiterfahren und einen autorisierten MV Agusta Kundendienst benachrichtigen.

Betriebsmodus "SPORT"

Zeigt an, dass die Einspritz-Zündelektronik im Betriebsmodus Sport arbeitet.

Tachometer

Zeigt die Geschwindigkeit an. Der Wert kann in Kilometer pro Stunde (km/h) oder Meilen pro Stunden (Mph) angezeigt werden. Der Wert bei Vollausschlag ist 320 km/h (199 Mph).

Taste "SET"

Wenn sie gedrückt wird, können die Ziffern am Display für die Einstellungen ausgewählt werden.

Taste "OK"

Mit dem Drücken der Taste wird die Eingabe der Ziffern bestätigt.

Taste "HAZARD"

Durch Drücken dieser Taste wird die Warnblinkanlage eingeschaltet.

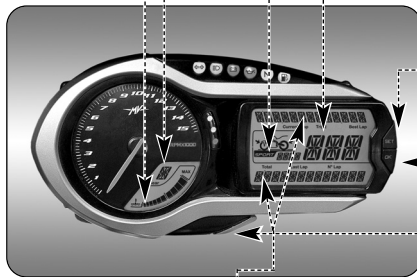

Gesamt-Kilometerzähler "TOTAL"

Zeigt den Gesamt-Kilometerstand an; von 0 bis 999999 (km oder mi)

Teilstrecken-Kilometerzähler 1 "TRIP 1"

Zeigt den Teilstrecken-Kilometerstand an; von 0 bis 999.9 (km oder mi)

Teilstrecken-Kilometerzähler 2 "TRIP 2"

Zeigt den Teilstrecken-Kilometerstand an; von 0 bis 999.9 (km oder mi)

Chronometer/ Zeitmesser

Zeigt die mit dem Chronometer gemessenen Zeiten an.



3.8. Schmiermitteltabelle

Beschreibung	Empfohlenes Produkt	Technische Angaben
Motoröl	AGIP RACING 4T 10W/60 (*)	SAE 10W/60 - API SJ
Kühlflüssigkeit	AGIP ECO - PERMANENT	Glykolethylen mit 50% destilliertem Wasser verdünnt
Brems- und Kupplungsflüssigkeit	AGIP BRAKE FLUID DOT4	DOT4
Kettenöl	MOTUL CHAIN LUBE ROAD	-

* : Damit Sie die empfohlenen Produkte finden und kaufen können, empfiehlt Ihnen MV Agusta sich direkt an die autorisierten Vertragshändler zu wenden. Das Motoröl AGIP Racing 4T 10W/60 wurde speziell für den Motor des Motorrads Brutale entwickelt. Steht das empfohlene Schmiermittel nicht zu Verfügung, rät MV Agusta zum Gebrauch vollständig synthetischer Öle, die die gleichen oder bessere Eigenschaften als folgende Normen haben:

- Konform API SJ
- Konform ACEA A3
- Konform JASO MA
- Grad SAE 20 W-50 oder 10 W-60

ANMERKUNG

Die o. a. Spezifizierungen müssen entweder allein oder zusammen mit anderen auf dem Behälter des Motoröl aufgedruckt sein.





4.1. Einsatz des Motorrads

In diesem Abschnitt werden die wichtigsten Themen für einen richtigen Einsatz des Motorrades behandelt.



ACHTUNG

Das Motorrad Brutale 990 R zeigt hohe Leistungsmerkmale. Für sein Gebrauch wird ein ausreichendes Niveau des Wissens des Fahrzeugs angefordert. Wenn Sie dieses Motorrad zum ersten Mal benutzen, ist es notwendig, eine vorsichtige Haltung anzunehmen. Eine konkurrenzfähige Ridinghaltung kann die Gefahr der Unfälle erhöhen, welche die Sicherheit des Treibers und der Leute gefährden.



ACHTUNG

DIE BESCHRÄNKUNGEN FÜR DIE ERLAUBTE NUTZUNG DES FAHRZEUGES FINDEN SIE IM ABSCHNITT "SICHERHEITSINFORMATIONEN".



4.2. Einfahren



Vorsicht – Vorsichtsmaßnahme: Die Nichtbeachtung der nachstehenden Anweisungen kann die Haltbarkeit und die Leistungen des Motorrads beeinträchtigen.

Normalerweise denkt man beim Einfahren nur an einen Zeitraum, der für den Motor gilt. Tatsächlich müssen aber auch andere wichtige Motorradteile mit berücksichtigt werden, speziell die Reifen, die Bremsen, die Antriebskette usw. Die ersten Kilometer müssen ruhig gefahren werden.

Von 0 bis 500 km (von 0 bis 300 mile) (A)

Während dieser ersten Fahrtstrecke sollte die Motordrehzahl häufig geändert werden. Wenn möglich, sollten hügelige und kurvenreiche Strecken gefahren und längere gerade Strecken vermieden werden.



ACHTUNG: Um volle Effizienz zu erreichen, müssen neue Reifen entsprechend eingefahren werden. Während der ersten 100 km starke Beschleunigungen, Kurven und Vollbremsungen vermeiden. Wird diese anfängliche Einfahrtzeit für die Reifen nicht beachtet, besteht Unfallgefahr wegen Rutschen oder Kontrollverlust über das Fahrzeug.



□ **Von 500 bis 1000 km (von 300 bis 600 mile)**

Während dieser Fahrtstrecke sollte vermieden werden den Motor länger unter Volllast zu halten.

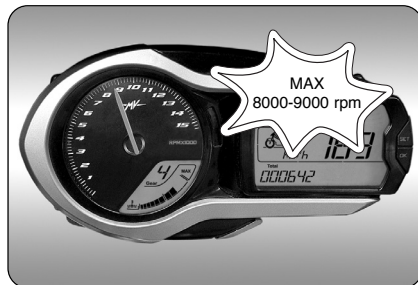

□ **Von 1000 bis 2500 km (von 600 bis 1600 mile)**

Während dieser Fahrtstrecke können vom Motor größere Leistungen verlangt werden, allerdings ohne die angegebene Motor-Drehzahl zu überschreiten.

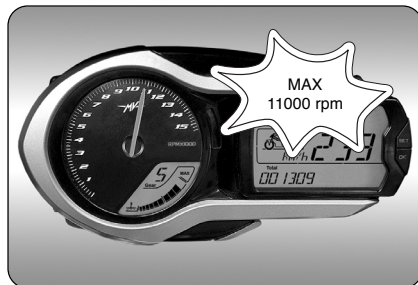



4.3. Starten des Motors



ACHTUNG

Das Fahrzeug in geschlossenen Räumen laufen zu lassen ist gefährlich. Die Abgase enthalten Kohlenmonoxid, ein farbloses und geruchloses Gas, das tödlich sein oder zu schweren Unfällen führen kann. Den Motor nur Außen, in der freien Luft laufen lassen.

DE 4

► Wird der Zündschalter auf "ON" gedreht, wird von den Instrumenten und den Kontrolllampen eine Autodiagnose ausgeführt. Während dieser Phase sollte geprüft werden, dass sich alle Kontrolllampen am Armaturenbrett einschalten.

Damit das System für die Zündkreis-Unterbrechung die Startfreigabe gibt, muss eine der folgenden Bedingungen erfüllt sein:

- Die Schaltung ist auf Leerlaufposition und der Kupplungshebel ist gezogen.
- Bei der Schaltung ist ein Gang eingelegt, der Kupplungshebel ist gezogen und der Seitenständer hochgeklappt.





► Wenn die Autodiagnose erkennt eine Störung am Fahrzeug, das Display zeigt die Warnung in der gezeigten Bild. Insbesondere das Display zeigt die Teil des Motorrads, auf denen das Störung festgestellt wurde.



► Die Taste "OK" drücken, bis die Funktion "RUN" angezeigt wird.

**ACHTUNG**

Wird ein Störung am Fahrzeug erkannt wird, nicht den Motor starten und einen autorisierten MV Agusta Kundendienst benachrichtigen.



**❑ Kaltstart**

▶ Den "CHOKE" Hebel drehen, ohne dabei den Gasgriff zu drehen.

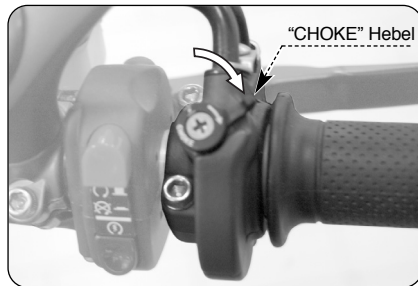

▶ Den Anlasserschalter drücken.

▶ Sobald der Motor gestartet ist, den Anlasserschalter loslassen, und nach kurzer Warmlaufzeit den "CHOKE" Hebel auf Ausgangsposition zurückstellen. Den Gasgriff drehen.

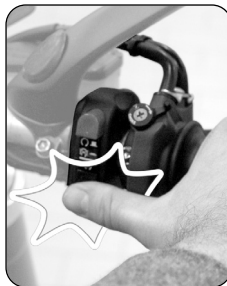



□ Starten mit warmen Motor

- ▶ Den Anlasserschalter drücken, ohne den Gasgriff zu drehen.
- ▶ Sobald der Motor gestartet ist, den Anlasserschalter loslassen.



Vorsicht – Vorsichtsmaßnahme:

- Um Schäden an der elektrischen Anlage zu vermeiden, den Anlasserschalter nicht länger als 5 Sekunden gedrückt halten.
 - Den Motor nicht über längere Zeit bei stehendem Motorrad laufen lassen. Die daraus folgende Überhitzung kann interne Motor-Bauteile beschädigen.
- Der Motor sollte bei langsamer Fahrt auf Betriebstemperatur gebracht werden.
- Um die Haltbarkeit des Motors zu verlängern, bei kaltem Motor kein Vollgas geben.





4.4. Auswahl und Ändern der Display-Funktionen

Die Instrumentenausrüstung sieht vor, dass einige der wichtigsten Mess-Parameter geändert werden können.

Es ist folgendes möglich:

- Auswahl des Betriebsmodus:
 - “RUN” (Kilometerzähler)
 - “CHRONO” (Chronometer)
 - “SERVICE” (Fälligkeit Wartungsprogramm)
 - “TC” (Traktionskontrolle)
 - “IMMOBILIZER” (Anlage Diebstahlsicherung)
- Nullstellen der Funktionen des Teilstrecken-Kilometerzählers:
 - Teilstrecken-Kilometerzähler 1 “TRIP 1”
 - Teilstrecken-Kilometerzähler 2 “TRIP 2”
- Einstellung der Messeinheiten für:
 - Geschwindigkeit
 - Gefahrenere Fahrtstrecke
- Einschalten der Chronometer-Funktion
- Auswahl Mapping Zündelektronik *

(*): Diese Funktion gibt es nur an einigen Modellen





4.4.1. Auswahl Display-Funktionen

Die Auswahl bezieht sich auf folgende Betriebsmodalitäten:

- "RUN" (Kilometerzähler)
- "CHRONO" (Chronometer)
- "SERVICE" (Fälligkeit Wartungsprogramm)
- "TC" (Traktionskontrolle)
- "IMMOBILIZER" (Anlage Diebstahlsicherung)

Die Anzeige der einzelnen Betriebsmodalitäten erfolgt durch Druck auf die Taste "SET" für weniger als 4 Sekunden. Bei Betätigung der Taste werden die Funktionen zyklisch am Display angezeigt. Die gewünschte Funktion auswählen.

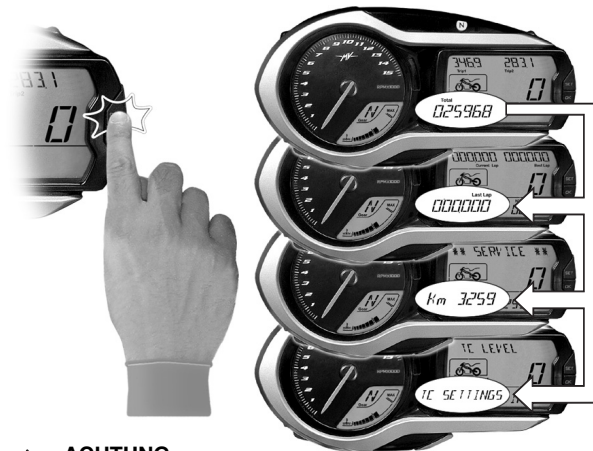

ACHTUNG

Änderungen oder Einstellungen an den Displayfunktionen müssen bei ausgeschaltetem Motor, Schaltung in Leerlauf, angehaltenem Motorrad und Füßen auf dem Boden ausgeführt werden. Eine Änderung der Displayeinstellungen während der Fahrt ist verboten.



□ Betriebsmodus "RUN"

Außer der Tachometerfunktion werden am Display folgende Funktionen angezeigt (siehe §4.4.2.):

- Gesamt-Kilometerzähler "TOTAL"
- Teilstrecken-Kilometerzähler 1 "TRIP 1"
- Teilstrecken-Kilometerzähler 2 "TRIP 2"



□ Betriebsmodus "CHRONO"

Mit diesem Betriebsmodus kann die Chronometerfunktion sowie das Speichern der Messdaten eingeschaltet werden (siehe §4.4.4.). Folgende Funktionen werden angezeigt:

- Chronometer Aktuelle Runde "CURRENT LAP"
- Chronometer Schnellste Runde "BEST LAP"
- Chronometer Letzte Runde "LAST LAP"
- Rundenzähler Runden-Gesamtanzahl "N° LAP"





❑ Betriebsmodus "SERVICE"

In diesem Betriebsmodus wird die Kilometerzahl bis zur Fälligkeit für die Arbeiten des nächsten Wartungsprogramms angezeigt.

ANMERKUNG

Ist die Kilometerzahl bis zur Fälligkeit für die Arbeiten des nächsten Wartungsprogramms kleiner als 1000 km, wird der entsprechende Wert nach dem Start des Motorrads am Display angezeigt.

❑ Betriebsmodus "TC"

Mit dieser Funktion kann die Motor-Traktionskontrolle den eigenen Fahransprüchen angepasst werden (siehe §4.4.5.).

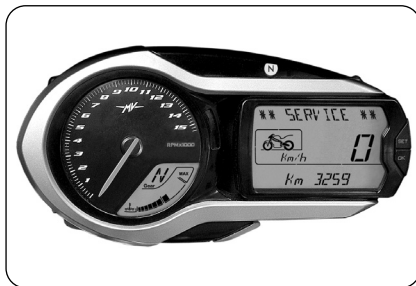

4 DE





□ Betriebsmodus "IMMOBILIZER"

Die Funktion "IMMOBILIZER" (Wegfahrsperre) ermöglicht ein Starten des Motors nur, nachdem der Original-Zündschlüssel erkannt worden ist. Es handelt sich um eine, in den elektronischen Schaltkreis des Fahrzeugs integrierte, Diebstahlsicherung, die allen nicht autorisierten Personen die Nutzung des Fahrzeugs verwehrt. Der Betriebsmodus "IMMOBILIZER" am Armaturenbrett darf nur bei Störungen benutzt werden. Sollte der Originalschlüssel aus irgend einem Grund nicht von der Anlage erkannt werden, muss der Geheimcode, der auf der MV Code Card angegeben ist, manuell eingegeben werden, um die Motor-Startfreigabe zu erhalten (siehe §4.4.6.).





4.4.2. Nullstellen der Funktionen des Teilstrecken-Kilometerzählers

Die Werte der Funktionen "TRIP 1" und "TRIP 2" können wie folgt auf Null zurückgestellt werden:



ACHTUNG

Änderungen oder Einstellungen an den Displayfunktionen müssen bei ausgeschaltetem Motor, Schaltung in Leerlauf, angehaltenem Motorrad und Füßen auf dem Boden ausgeführt werden. Eine Änderung der Displayeinstellungen während der Fahrt ist verboten.

- ▶ Den Betriebsmodus "RUN" öffnen und die Taste "SET" länger als 4 Sekunden drücken, bis "RUN MENU" angezeigt wird.
- ▶ Die Taste "SET" kürzer als 4 Sekunden drücken, bis "TRIP 1 RESET" angezeigt wird.

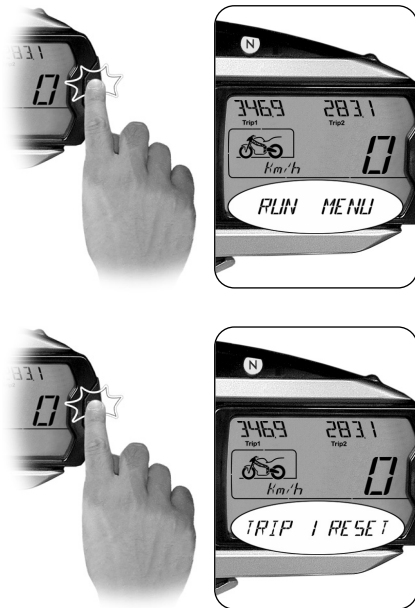



► Die Taste "OK" länger als vier Sekunden gedrückt halten. Der Wert "TRIP 1" fängt an zu blinken.

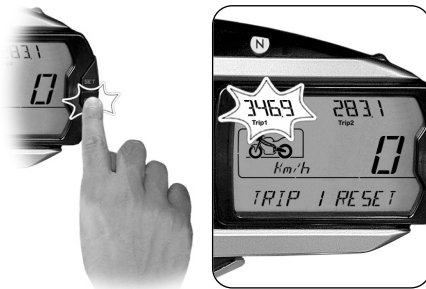

► Wird jetzt die Taste "OK" kürzer als vier Sekunden gedrückt gehalten, wird der Wert auf Null gestellt. Wird die Taste "SET" länger als vier Sekunden gedrückt gehalten, wird das Nullstellen abgebrochen.

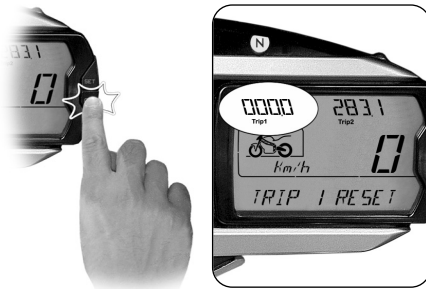



► Die Taste "SET" kürzer als 4 Sekunden drücken, bis "TRIP 2 RESET" angezeigt wird.

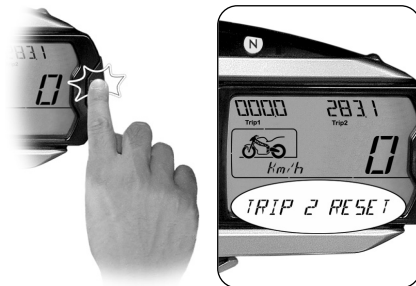

► Die Taste "OK" länger als vier Sekunden gedrückt halten. Der Wert "TRIP 2" fängt an zu blinken.





► Wird jetzt die Taste "OK" kürzer als vier Sekunden gedrückt gehalten, wird der Wert auf Null gestellt.
Wird die Taste "SET" länger als vier Sekunden gedrückt gehalten, wird das Nullstellen abgebrochen.

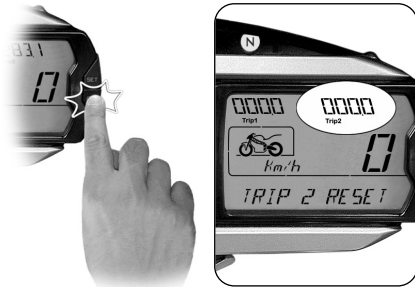

► Bei einem weiteren Druck auf die Taste "OK" wird der Betriebsmodus "TRIP 2 RESET" beendet und auf den nächsten Betriebsmodus umgeschaltet.

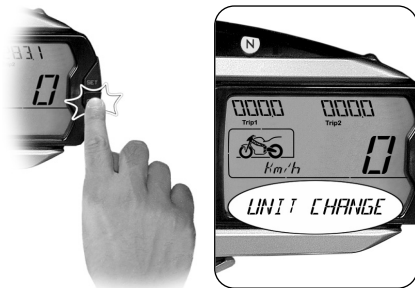



4.4.3. Einstellung der Messeinheiten

Folgende Messeinheiten können gleichzeitig geändert werden:

- Geschwindigkeit
- Fahrstrecke



ACHTUNG

Änderungen oder Einstellungen an den Displayfunktionen müssen bei ausgeschaltetem Motor, Schaltung in Leerlauf, angehaltenem Motorrad und Füßen auf dem Boden ausgeführt werden. Eine Änderung der Displayeinstellungen während der Fahrt ist verboten.

- ▶ Den Betriebsmodus "RUN" öffnen und die Taste "SET" mehrfach drücken, bis "UNIT CHANGE" angezeigt wird
- ▶ Die Taste "OK" länger als vier Sekunden gedrückt halten. Die Messeinheit des Tachometers fängt an zu blinken.

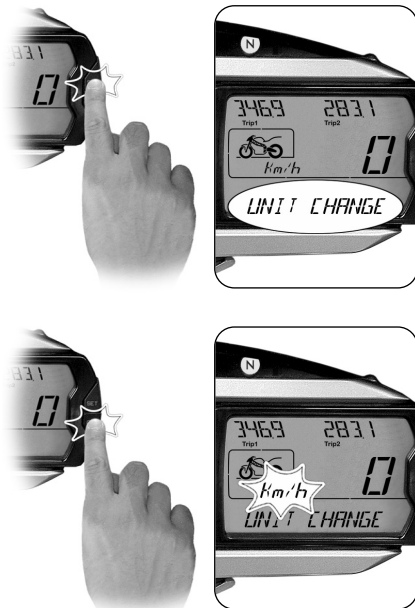



► Zum Umstellen von km/h auf Mph, oder umgekehrt, die Taste "OK" drücken. Bei einer Änderung der Messeinheit am Tachometer ändern sich automatisch auch folgende Messeinheiten:

- Kilometerzähler (Gesamt und Teilstrecke): Km → mi

Wird die Taste "SET" länger als vier Sekunden gedrückt gehalten, wird das Verfahren zum Ändern der Messeinheiten abgebrochen.

► Wird die Taste "OK" länger als vier Sekunden gedrückt gehalten, wird die neue Einstellung der Messeinheiten bestätigt.

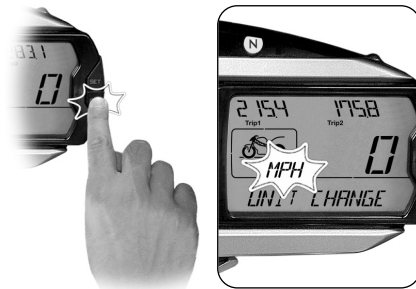

DE 4



4.4.4. Chronometer/ Zeitmesser

□ Rundenzeiterfassung

► Nachdem die Chronometer-Funktion eingeschaltet worden ist (Betriebsmodus "CHRONO"), kann mit der Datenerfassung bezüglich der Rundenzeiten begonnen werden.

► Bei Betätigung der Lichthupentaste wird mit der Datenmessung begonnen. Die kleinen Punkte, mit denen die Minutenanzeige von der Sekundenanzeige und von den Zehntel Sekunden getrennt ist, fangen an zu blinken. Das Instrument fängt an die Zeiten zu erfassen.

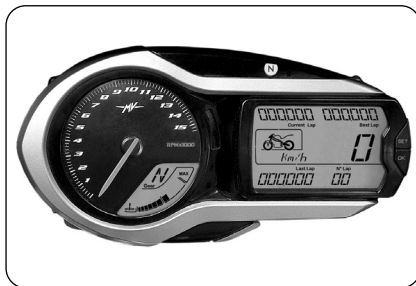



► Bei erneutem Druck auf die Lichthupentaste wird die Messzeit zur ersten gefahrenen Runde registriert. Gleichzeitig beginnt das Instrument mit der Erfassung der zweiten Rundenzeit.

Die Messzeit zur ersten gefahrenen Runde wird im Speicher gespeichert und, bis zur Erfassung der nächsten Rundenzeit, am Display als "LAST LAP" angezeigt.



► Wird das Chronometer weiter benutzt, wird bei jeder Betätigung der Lichthupentaste eine Zeit registriert. Mit dem Instrument können maximal bis zu 100 aufeinander folgende Daten gespeichert werden.

Ist die eben erfasste Rundenzeit kürzer als die vorherigen Rundenzeiten, wird die Anzeige "BEST LAP" am Display automatisch durch den neuen Wert ersetzt.





□ Anzeige der Daten

Nach der Erfassung der Zeiten können die Daten angezeigt werden.

► Den Betriebsmodus "CHRONO" öffnen und die Taste "SET" länger als 4 Sekunden drücken, bis "CHRONO MENU" angezeigt wird.



ACHTUNG

Änderungen oder Einstellungen an den Displayfunktionen müssen bei ausgeschaltetem Motor, Schaltung in Leerlauf, angehaltenem Motorrad und Füßen auf dem Boden ausgeführt werden. Eine Änderung der Displayeinstellungen während der Fahrt ist verboten.

► Die Taste "SET" kürzer als 4 Sekunden drücken, bis "LAPS VIEW" angezeigt wird.

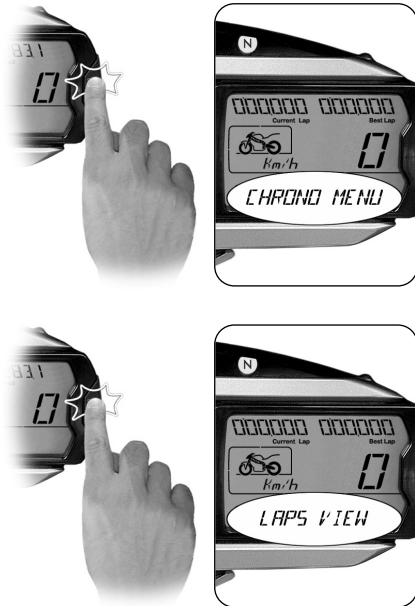



► Wird die Taste "OK" gedrückt, wird die schnellste Rundenzeit ("BEST LAP") und die Nummer der entsprechenden Runde angezeigt.

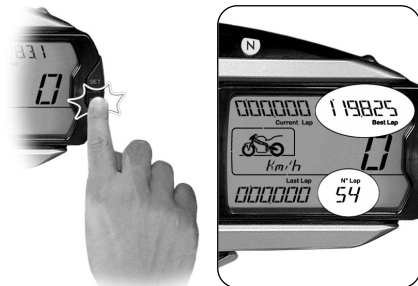

► Anschließend können durch wiederholten Druck auf die Lichthupentaste nacheinander alle vorher erfassten Zeiten ab der ersten Runden angezeigt werden.

► Am Ende der Datenanzeige kann durch Druck auf die Taste "SET" der Betriebsmodus "LAPS VIEW" beendet und auf den nächsten Modus umgestellt werden.

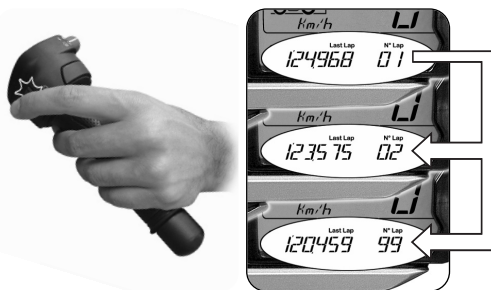



□ Löschen der Daten

Die gespeicherten Daten können wie folgt gelöscht werden:

► Den Betriebsmodus "CHRONO" öffnen und die Taste "SET" länger als 4 Sekunden drücken, bis "CHRONO MENU" angezeigt wird.



ACHTUNG

Änderungen oder Einstellungen an den Displayfunktionen müssen bei ausgeschaltetem Motor, Schaltung in Leerlauf, angehaltenem Motorrad und Füßen auf dem Boden ausgeführt werden. Eine Änderung der Displayeinstellungen während der Fahrt ist verboten.

► Die Taste "SET" mehrfach kürzer als 4 Sekunden drücken, bis "BEST LAP RESET" angezeigt wird.

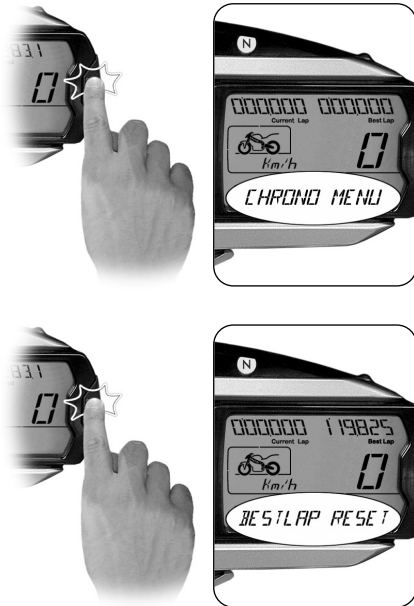



► Die Taste "OK" länger als vier Sekunden gedrückt halten. Der Wert "BEST LAP" fängt an zu blinken.



► Wird jetzt die Taste "OK" kürzer als vier Sekunden gedrückt gehalten, wird der Wert gelöscht. Wird hingegen die Taste "SET" länger als vier Sekunden gedrückt gehalten, wird das Lösungsverfahren abgebrochen.

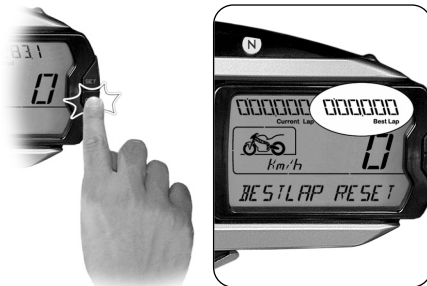

DE 4



► Die Taste "SET" kürzer als 4 Sekunden drücken, bis "LAPS RESET" angezeigt wird.



► Die Taste "OK" länger als vier Sekunden gedrückt halten. Der Wert "LAST LAP" fängt an zu blinken.





► Wird jetzt die Taste "OK" kürzer als vier Sekunden gedrückt gehalten, werden alle vorher gespeicherten Zeiten gelöscht.

Wird hingegen die Taste "SET" länger als vier Sekunden gedrückt gehalten, wird das Löschverfahren abgebrochen.

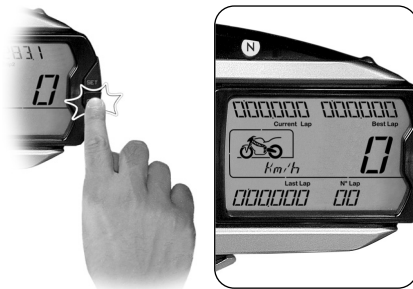
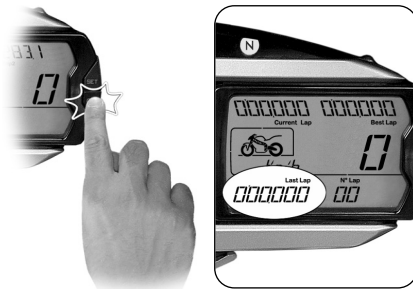

► Bei einem weiteren Druck auf die Taste "OK" wird der Betriebsmodus "LAPS RESET" beendet und auf die Chronometer-Funktion zurückgeschaltet.

DE 4



4.4.5. Betriebsmodus "TC"

► Die Taste "SET" drücken, bis den Betriebsmodus "TC" öffnen; dann die Taste "SET" länger als 4 Sekunden drücken, bis "TC LEVEL" angezeigt wird. Die aktuelle Stufe für die Traktionskontrolle entspricht dem am Display angezeigten Wert.



ACHTUNG

Änderungen oder Einstellungen an den Displayfunktionen müssen bei ausgeschaltetem Motor, Schaltung in Leerlauf, angehaltenem Motorrad und Füßen auf dem Boden ausgeführt werden. Eine Änderung der Displayeinstellungen während der Fahrt ist verboten.

► Wird die Taste "OK" weniger als 4 Sekunden gedrückt, wird die Stufe für die Traktionskontrolle auf den nächsten Wert erhöht. Dieser Wert kann zwischen 0 und 8 eingestellt werden.

► Wird die Taste "OK" weniger als 4 Sekunden gedrückt, wird der ausgewählte Wert für die Stufe der Traktionskontrolle bestätigt.

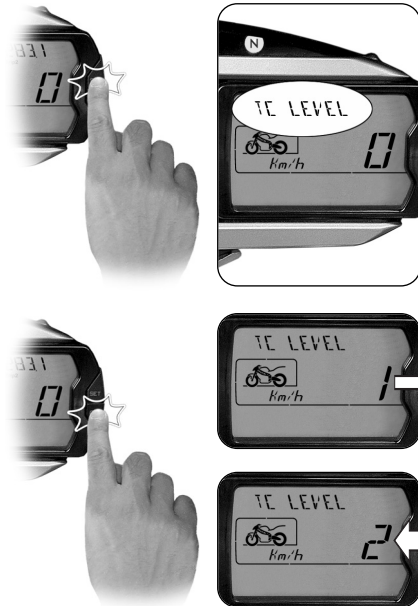



4.4.6. Betriebsmodus "IMMOBILIZER"

Bei einer Fehlfunktion kann es passieren, dass die Anlage den Code des Zündschlüssels nicht erkennt und daher das Starten des Motors sperrt. Um die Motor-Startfreigabe zu erhalten, muss der Geheimcode eingegeben werden, der auf der MV Code Card angegeben ist, die zusammen mit dem Fahrzeug übergeben wurde.

- ▶ Die Abdeckung vom Textkasten auf der Rückseite der MV Code Card entfernen und den elektronischen Geheimcode für den Zündschlüssel ablesen (in der Abbildung ist ein reiner Beispielwert für den Code angegeben).
- ▶ Den Betriebsmodus "IMMOBILIZER" öffnen und die Taste "SET" länger als 4 Sekunden drücken, bis "INSERT CODE" angezeigt wird.



ACHTUNG

Änderungen oder Einstellungen an den Displayfunktionen müssen bei ausgeschaltetem Motor, Schaltung in Leerlauf, angehaltenem Motorrad und Füßen auf dem Boden ausgeführt werden. Eine Änderung der Displayeinstellungen während der Fahrt ist verboten.

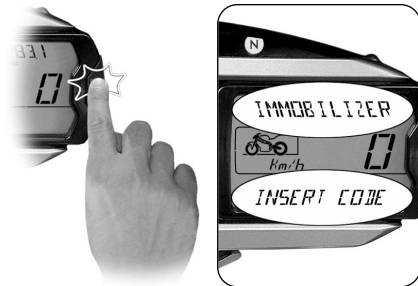



- ▶ Die Taste "SET" kürzer als 4 Sekunden drücken, um die erste Ziffer des Code einzugeben.
- ▶ Wird die Taste "OK" kürzer als 4 Sekunden gedrückt, kann der Wert für die erste Ziffer zwischen 0 und 9 eingestellt werden.

- ▶ Ist die gewählte Ziffer richtig eingestellt worden, die Taste "OK" länger als 4 Sekunden gedrückt halten. Auf diese Weise wird die erste Ziffer des Code bestätigt. Jetzt kann die zweite Ziffer des Code eingegeben werden.
- ▶ Auf die gleiche Weise wie bei der ersten Ziffer können auch die restlichen vier Ziffern eingegeben werden.

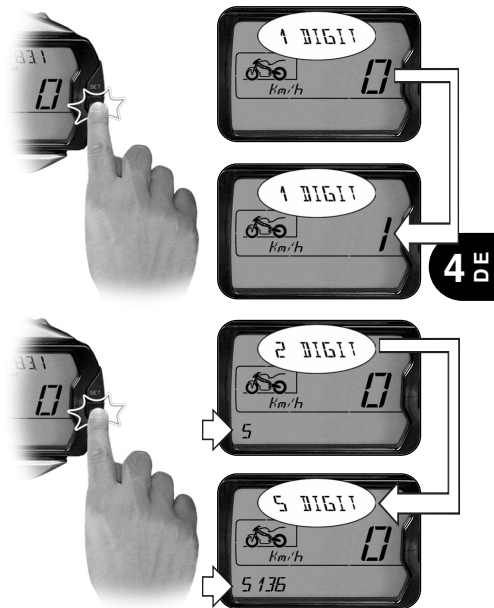



▶ Nach Abschluss des Verfahrens für die Code-Eingabe erscheint am Display die Meldung "CONFIRM CODE". Die Taste "OK" länger als vier Sekunden gedrückt halten, um den eingegebenen Code zu bestätigen.

▶ Wird der eingegebene Code richtig vom System erkannt, erscheint die Meldung "VALID CODE". Das Armaturenbrett-Display stellt sich auf die Betriebsmodalität "RUN" zurück. Der Motor kann gestartet werden.

▶ Ist ein falscher Code eingegeben worden, erscheint die Meldung "NOT VALID CODE". Das System gibt keine Starfreigabe für den Motor. Das Armaturenbrett-Display stellt sich auf die Betriebsmodalität "INSERT CODE" zurück. Das Verfahren für die Code-Eingabe von Anfang an wiederholen. Darauf achten, dass alle auf der MV Code Card angegebenen Ziffern richtig eingegeben werden. Sollten weitere Probleme auftreten, bitte einen autorisierten MV Agusta Kundendienst benachrichtigen.

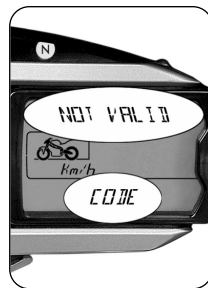
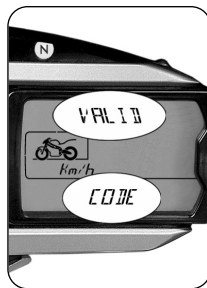
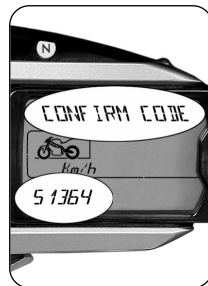



4.4.7. Auswahl Mapping Zündelektronik *

An einigen Brutale-Modellen kann ein spezielles Mapping für die Zündelektronik ausgewählt werden. Damit können hohe Kraft- und Leistungswerte für einen besonders sportlichen Einsatz des Fahrzeugs erhalten werden.

Die Auswahl des Steuerelektronik-Mappings kann bei laufendem Motor durch Druck auf den Anlasserschalter erfolgen. Die Aktivierung des Mapping "SPORT" wird durch die entsprechende Anzeige am Armaturenbrett-Display angezeigt.



ACHTUNG

Auswahl der Mapping Zündelektronik muss bei laufendem Motor, Schaltung in Leerlauf, angehaltenem Motorrad und Füßen auf dem Boden ausgeführt werden. Eine Änderung der Displayeinstellungen während der Fahrt ist verboten.

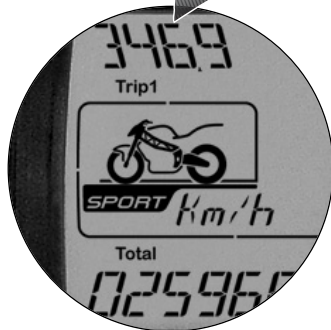

(*): Diese Funktion gibt es nur an einigen Modellen



4.4.8. Warnung / Störmeldung

Das Instrumentenausrüstung kann das Vorhandensein eines Störungs während der verschiedenen Bedingungen von die Verwendung des Motorrades zeigen.

► *Starten des Motors:* Wird der Zündschalter auf "ON" gedreht, wird von den Instrumenten und den Kontrolllampen eine Autodiagnose ausgeführt. Wenn die Autodiagnose erkennt eine Störung am Fahrzeug, das Display zeigt die Warnung in der gezeigten Bild. Insbesondere das Display zeigt die Teil des Motorrads, auf denen das Störung festgestellt wurde.

► Die Taste "OK" drücken, bis die Funktion "RUN" angezeigt wird.



ACHTUNG

Wird ein Störung am Fahrzeug erkannt wird, nicht den Motor starten und einen autorisierten MV Agusta Kundendienst benachrichtigen.





► *Fahren des Fahrzeugs:* Wenn ein Störung während der Fahrt entdeckt wird, den unteren Teil des Displays dargestellt die Warnung in der Abbildung.

**ACHTUNG**

Wenn ein Störung während der Fahrt festgestellt, das Fahrzeug zu stoppen und einen autorisierten MV Agusta Kundendienst benachrichtigen.

► Wenn das Fahrzeug gestoppt wird, das Display zeigt die Teil des Motorrads, auf denen das Störung festgestellt wurde.



4 DE





► *Hohe Kühflüssigkeitstemperatur:* Wenn eine hohe Kühflüssigkeitstemperatur erkannt wird, das Display zeigt die Warnung in der gezeigten Bild. Diese Warnung kann bei jeder Bedingung von die Verwendung des Fahrzeugs angezeigt.

**ACHTUNG**

Bei hoher Temperatur das Fahrzeug anhalten und den Kühflüssigkeitsstand kontrollieren. Muss nachgefüllt werden, wenden Sie sich bitte an einen autorisierten MV Agusta Kundendienst (siehe § 3.8). Erscheint die Anzeige auch bei richtigem Kühflüssigkeitsstand, nicht weiterfahren und einen autorisierten MV Agusta Kundendienst benachrichtigen.





4.5. Tanken



Gefahr - Achtung: Benzin und Benzindämpfe sind leicht entzündbar und giftig. Kontakt mit Benzin und Einatmen vermeiden. Beim Tanken den Motor abschalten und nicht rauchen, offene Flammen und Hitzequellen fernhalten. Im Freien oder in gut belüfteten Räumen tanken.



Vorsicht - Vorsichtsmassnahme: Ausschließlich bleifreies Superbenzin mit einer Oktanzahl (R.O.N.) von 95 oder mehr tanken. Auf die Notwendigkeit bleifreies Benzin zu tanken, werden Sie durch den grünen Punkt, der auf der Unterseite des Tankdeckels angebracht ist.

- ▶ Den Staubschutzdeckel anheben.
- ▶ Den Schlüssel einstecken und in Uhrzeigersinn drehen.

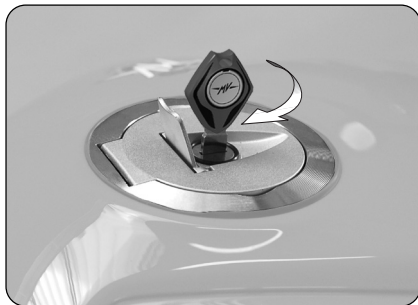
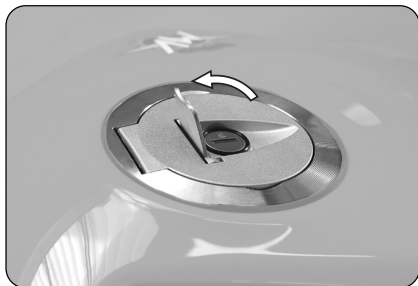



- ▶ Den Einfüllstutzen abnehmen und mit Benzin tanken.

**ACHTUNG**

Wird der Tank bis zum Rand gefüllt, kann Benzin austreten, das sich durch Sonneneinwirkung oder die Motorwärme ausdehnen kann. Bei austretendem Benzin besteht Brandgefahr. Der Benzinstand darf nie über dem Ende des Einfüllstutzens stehen.

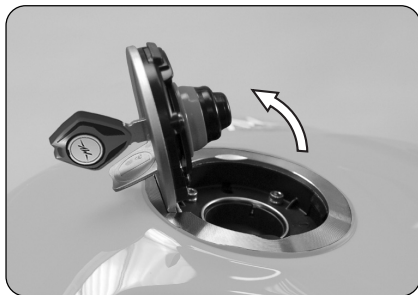

- ▶ Nach dem Tanken den Tankdeckel nach unten drücken und gleichzeitig den Schlüssel in Uhrzeigersinn drehen. Den Schlüssel loslassen und abziehen.



Vorsicht - Vorsichtsmassnahme: Eventuelle ausgetropftes Benzin sofort mit einem sauberen Lappen abwischen, andernfalls können Lack oder Plastikteile beschädigt werden.

**ACHTUNG**

Vorm Losfahren prüfen, ob der Tankdeckel richtig verschlossen ist.





4.6. Zugang zum Staufach

- ▶ Den Schlüssel ins Schloss einstecken.
- ▶ Den Schlüssel in Uhrzeigersinn drehen und gleichzeitig leicht auf den Fahrersitz drücken. Den Sitz herausheben.

Zum Wiederaussetzen des Beifahrersitzes sind folgende Punkte zu berücksichtigen:

- Den Schlüssel im Schloss drehen
- Den Fahrersitz nach unten drücken
- Den Schlüssel loslassen
- Den Sitz wiederum nach unten drücken und nachprüfen ob er an der Struktur fest befestigt ist.

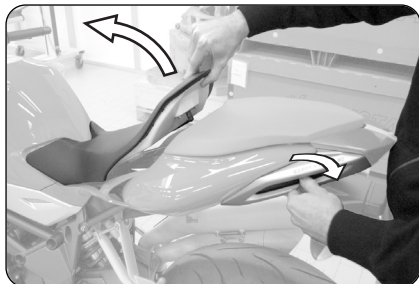

ACHTUNG

Nach Demontage oder Abhebung des Fahrersitzes und vor jedem Motorrad Einsatz muss man sich vergewissern, dass dieser Bauteil korrekt angebracht und an der Tragstruktur des Fahrzeuges gut befestigt ist.



4.7. Parken des Motorrads

□ Parken auf dem Seitenständer



ACHTUNG: Das Motorrad stets sicher auf festem Untergrund abstellen. Beim Parken auf abschüssigem Gelände das Vorderrad bergauf stellen und den ersten Gang einlegen. Vorm Starten muss wieder der Leerlauf eingelegt werden. Niemals den Zündschlüssel stecken lassen, wenn das Fahrzeug unbeaufsichtigt ist. Wird das Motorrad zum Parken auf den Seitenständer gestellt, ist es gefährlich

- ▶ Den Seitenständer mit dem Fuß bis zum Anschlag ausklappen und das Motorrad langsam neigen, bis der Ständerfuß auf dem Untergrund fest aufliegt.



sich auf das Fahrzeug zu setzen, da das gesamte Gewicht nur auf dem Seitenständer aufliegt. Vorm Losfahren die Funktion des Sicherheitsschalters prüfen. Die Kontrolllampe am Armaturenbrett für den abgeklappten Seitenständer muss sich ausschalten. Auf jeden Fall prüfen, dass der Seitenständer richtig hochgeklappt ist. Wird eine Störung bemerkt, muss die Anlage vor Fahrtantritt bei einem MV Agusta Vertragshändler überprüft werden.



□ Parken auf dem hinteren Ständer

Den Zapfen des Ständer von der linken Fahrzeugseite aus in die Öffnung an der Radachse stecken. Den Ständer auf den Boden stellen, festhalten und das Fahrzeug soweit anheben, bis es sicher steht.



ACHTUNG

Dieser Vorgang muss von zwei Personen zusammen ausgeführt werden.

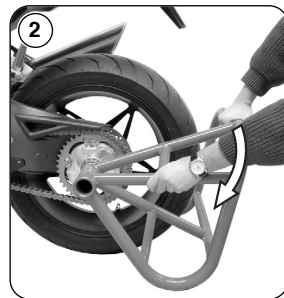
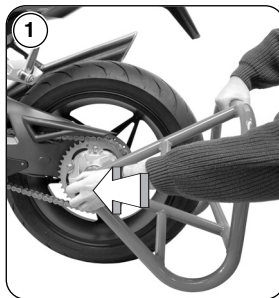



5.1. Liste der Einstellarbeiten

Das Motorrad bietet eine breite Auswahl von Einstellungsmöglichkeiten, die Ergonomie, die Sitzposition und die Sicherheit verbessern können.

Da eine falsche Einstellung von wichtigen Komponenten eine Gefahrenquelle darstellen kann, dürfen einige dieser Einstellungen nur von einer MV Agusta-Vertragswerkstatt vorgenommen werden.



ACHTUNG

Alle Einstellarbeiten müssen bei stehendem Fahrzeug vorgenommen werden.



(E) Einstellung Rückspiegel (§5.5.)

(F) Einstellung vordere Federung (§5.6)

(A) Einstellung Bremshebel

Vorderradbremse (§5.3.)

(L) Einstellung Scheinwerfer (§5.8.)

(G) Einstellung rechte

Fußraste (§5.7.)

(D) Einstellung Bremspedal

Hinterradbremse (§5.2.)

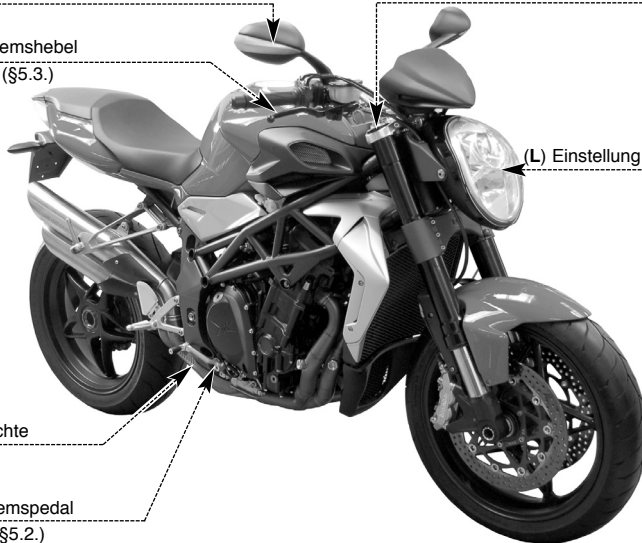



(E) Einstellung Rückspiegel (§5.5.)

(F) Einstellung vordere Federung (§5.6)

(B) Einstellung
Kupplungshebel (§5.4.)

(C) Einstellung
Schaltpedal (§5.2.)

(H) Einstellung Kette (§5.2.)

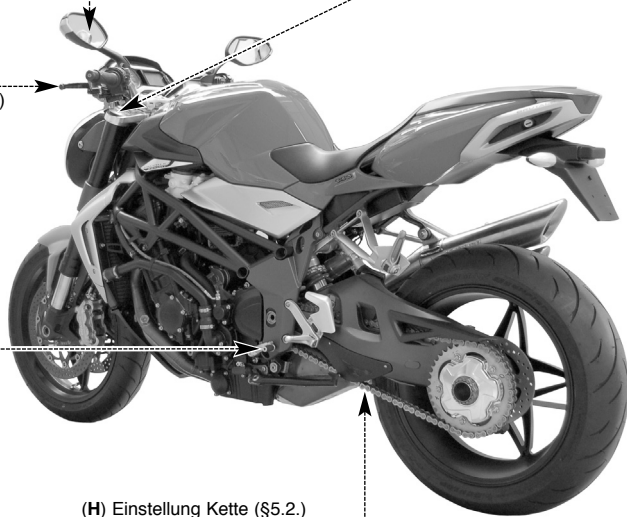







5.2. Tabelle der Einstellungsarbeiten

 **A - Einstellung Bremshebel Vorderradbremse:** Bessere Einstellung des Bremshebels auf die persönlichen Anforderungen des Fahrers (§5.3).

 **B - Einstellung Kupplungshebel:** Bessere Einstellung des Kupplungshebels auf die persönlichen Anforderungen des Fahrers (§5.4).

 **C - Einstellung Schaltpedal:** Bessere Einstellung des Schaltpedals auf die persönlichen Anforderungen des Fahrers.



 **D - Einstellung Bremspedal Hinterradbremse:** Bessere Einstellung des Bremspedals auf die persönlichen Anforderungen des Fahrers.

 **E - Einstellung Rückspiegel:** Zur besseren Einstellung (§5.5).
 **ACHTUNG:** Die Befestigungsschraube des Lenkerrückspiegels nie ausschrauben. Falls notwendig wenden Sie sich bitte nur einem MV Agusta-Händler.

 **F - Einstellung vordere Federung:** um die Federung an den persönlichen Fahrstil anzupassen, gibt es folgende Einstellmöglichkeiten:

- Federvorspannung (§5.6.1.)
- Hydraulische Ausdehnungsbremse (§5.6.2.)
- Hydraulische Kompressionsbremse (§5.6.3.)

G - Einstellung hintere Federung: um die Federung an den persönlichen Fahrstil anzupassen, gibt es folgende Einstellmöglichkeiten:

-  - Federvorspannung
-  - Höhe Sitzposition
-  - Hydraulische Ausdehnungsbremse (§5.7.1.)

 **H - Einstellung Kette:** Für Funktion und Sicherheit des Antriebs.

 **L - Einstellung Scheinwerfer:** Um den Lichtstrahl des Scheinwerfers entsprechend der Sitzposition einzustellen (§5.8).



5.3. Einstellung Bremshebel Vorderradbremse

Den Hebel ziehen, um den Federdruck auszugleichen. Gleichzeitig die Hebelposition durch Drehen der Nutmutter einstellen. Drehen in Uhrzeigersinn: der Hebel entfernt sich vom Handgriff. Drehen gegen den Uhrzeigersinn: der Hebel nähert sich an den Handgriff an.

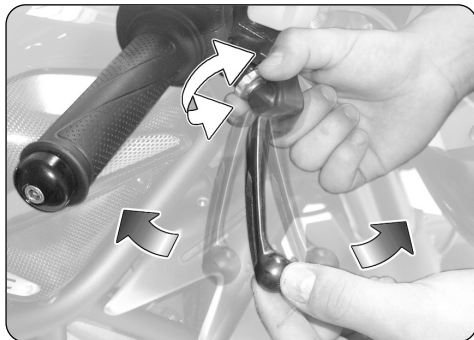

5.4. Einstellung Kupplungshebel

Den Hebel ziehen, um den Federdruck auszugleichen. Gleichzeitig die Hebelposition durch Drehen der Nutmutter einstellen. Drehen in Uhrzeigersinn: der Hebel entfernt sich vom Handgriff. Drehen gegen den Uhrzeigersinn: der Hebel nähert sich an den Handgriff an.





5.5. Einstellung Rückspiegel

Zur Einstellung des Rückspiegels an den vier in der Abbildung gezeigten Stellen drücken.

Die Einstellung beider Rückspiegel durchführen. Zur Durchführung einer korrekten Rückspiegeleinstellung ist es ratsam auf das Motorrad zu steigen..



5 DE



5.6. Einstellung vordere Federung



ANMERKUNG

Die Einstellung der Federungen muß vorzugsweise mit dem Benzintank volle durchgeführt werden.



Hydraulische
Ausdehnungsbremse
Federvorspannung

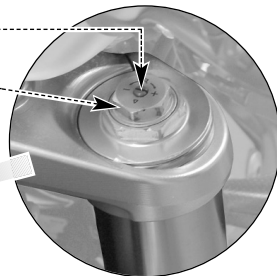

Hydraulische
Kompressionsbremse
Federvorspannung

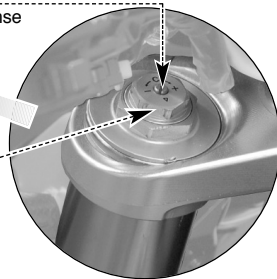

5.6.1. Federvorspannung

Für die Einstellungsarbeiten muß von der Standardeinstellung ausgegangen werden. Um die Standardeinstellung zu erreichen, gegen den Uhrzeigersinn bis zum Anschlag drehen, anschließend in Uhrzeigersinn bis Standardposition (siehe Tabelle) drehen. In Uhrzeigersinn drehen um die Federvorspannung zu erhöhen, gegen den Uhrzeigersinn drehen, um die Federvorspannung abzuschwächen.



5.6.2. Hydraulische Ausdehnungsbremse (Vorderradfederung)

Für die Einstellungsarbeiten muß von der Standardeinstellung ausgegangen werden. Um die Standardeinstellung zu erreichen, in Uhrzeigersinn bis zum Anschlag drehen, anschließend gegen den Uhrzeigersinn bis Standardposition (siehe Tabelle) drehen. In Uhrzeigersinn drehen um die Bremsleistung zu erhöhen, gegen den Uhrzeigersinn drehen, um die Bremsleistung abzuschwächen.





5.6.3. Hydraulische Kompressionsbremse (Vorderradfederung)

Für die Einstellungsarbeiten muß von der Standardeinstellung ausgegangen werden. Um die Standardeinstellung zu erreichen, in Uhrzeigersinn bis zum Anschlag drehen, anschließend gegen den Uhrzeigersinn bis Standardposition (siehe Tabelle) drehen. In Uhrzeigersinn drehen um die Bremsleistung zu erhöhen, gegen den Uhrzeigersinn drehen, um die Bremsleistung abzuschwächen.





5.7. Einstellung hintere Federung



Gefahr - Achtung: Die Auspuffrohre sind heiß - Verbrennungsgefahr. Den Motor ausschalten und vor der Einstellung abwarten, bis die Auspuffrohre abgekühlt sind.

ANMERKUNG: Die Einstellung der Federungen muß vorzugsweise mit dem Benzintank volle durchgeführt werden.



Hydraulische Ausdehnungsbremse

5.7.1. Hydraulische Ausdehnungsbremse (Hinterradfederung)

Die Einstellung wird bei Betätigung der Schraube, die sich im Unterteil des Stoßdämpfers befindet, ausgehend von der Standardposition, durchgeführt.

Um die Standardeinstellung zu erreichen, in Uhrzeigersinn bis zum Anschlag drehen, anschließend gegen den Uhrzeigersinn, bis Sie den ersten Klick zu hören. Aus dieser Position, gegen den Uhrzeigersinn bis Standardposition (siehe Tabelle) drehen.

In Uhrzeigersinn drehen um die Bremsleistung zu erhöhen, gegen den Uhrzeigersinn drehen, um die Bremsleistung abzuschwächen.

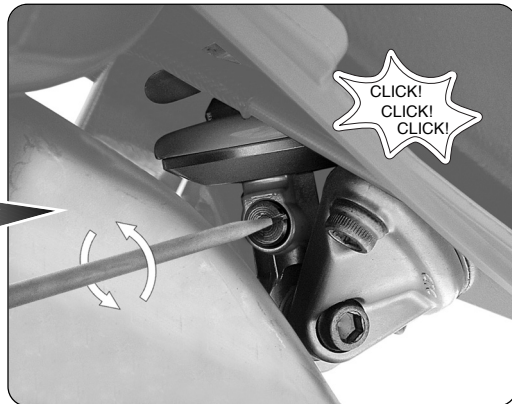

5.8. Scheinwerfereinstellung

Das Fahrzeug auf ebenem Untergrund in einem Abstand von 10 m vor eine Wand stellen. Das Fahrzeug muss aufrecht senkrecht zur Wand stehen. Den Abstand zwischen Scheinwerfermitte und Boden messen. Den Wert an der Wand mit einem Kreuz anzeichnen. Den Scheinwerfer einschalten und Fahrlicht einstellen. Den Lichtstrahl so einstellen, dass sich die Hell-Dunkel- Linie 9/10 unterhalb der an der Wand angebrachten Linie befindet.

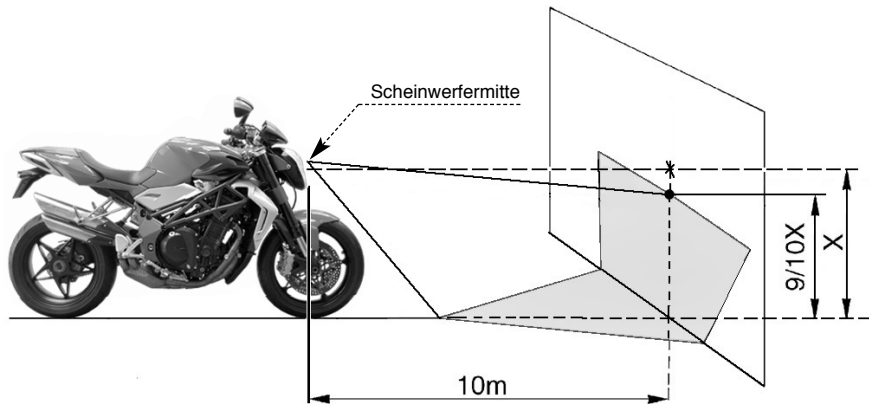



Die Einstellung des vorderen Scheinwerfers kann bei Betätigung der abgebildeten Schraube erfolgen. In Uhrzeigersinn: der Scheinwerfer wird nach unten geneigt. Gegen den Uhrzeigersinn: der Scheinwerfer wird nach oben geneigt. Die Neigung, hinsichtlich der Standardposition, kann von $\pm 4^\circ$ geändert werden.



DE 5



Informationshinweis

MV Agusta S.p.A. verfolgt eine Politik ständiger Verbesserung ihrer Produkte. Aus diesem Grund kann es vorkommen, dass kleine Abweichungen zwischen dem vorliegenden Dokument und dem von Ihnen erworbenen Fahrzeug bestehen. Die Modelle MV Agusta werden in zahlreiche Länder exportiert, in denen unterschiedliche Straßenverkehrsordnungen und Zulassungsverfahren bestehen. In der Hoffnung auf Ihr Verständnis behält sich MV Agusta S.p.A. deshalb das Recht vor, jederzeit und ohne Vorankündigung, Änderungen an ihren Produkten und den technischen Dokumentationen vorzunehmen.

Wir schlagen vor, um den Internetplatz www.mvagusta.it häufig zu besichtigen, um Informationen und Updates über die MV Agusta-Produkte und die in Verbindung stehenden Unterlagen zu erhalten.



Die Umwelt schützen und respektieren

Alles was wir tun hat Auswirkungen auf den gesamten Planeten und seine Ressourcen. Zum Schutz der Gemeinschaft weist MV Agusta die Kunden und die Angestellten im Kundendienst darauf hin, wie das Motorrad umweltschonend genutzt und Motorradbauteile und Flüssigkeiten entsprechend der geltenden Umweltschutzgesetze entsorgt bzw. dem Recycling zugeführt werden können.

© 2010

Die vollständige oder teilweise Vervielfältigung dieses Dokuments ist ohne vorherige schriftliche Genehmigung der MV Agusta S.p.A. verboten.

Teilnr. 8000B3247

Ausgabe nr. 2 - Juli 2010



ANMERKUNGEN

DE 5

BRUTALE
990R

MV AGUSTA



Manual de uso
Versión en Español

Estimado cliente,

Le agradecemos la confianza que nos ha otorgado y le felicitamos por su nueva Brutale 990 R. MV Agusta, gracias a la pasión y a la escrupulosidad de sus técnicos se propone nuevamente a sus aficionados con un producto caracterizado por una inédita cualidad estética junto a una refinada parte ciclística: elementos que han contramarcado todas las creaciones de la marca MV Agusta a lo largo de su gloriosa historia.

El resultado es una moto exclusiva que por sus características estéticas y funcionales y las innumerables innovaciones técnicas, se coloca por encima de productos de mas alto perfil que el mercado de la moto pueda ofrecer hoy.

Las soluciones adoptadas otorgan, en efecto, a Brutale 990 R ese inconfundible carácter que la atan a los otros modelos de la familia MV Agusta, reforzando una filosofía de proyecto que privilegia la constante búsqueda, innovación tecnológica y el amor por el detalle, dando la posibilidad a quien vive la propia pasión de motociclista en plena libertad, de poseer un objeto único en el mundo que se coloca con prepotencia como referencia en el ámbito mundial.

Si desea más información, no dude en ponerse en contacto con el Servicio de Asistencia Clientes de MV Agusta.

¡Buena diversión!

*Claudio Castiglioni
Presidente
MV Agusta*



ÍNDICE GENERAL

<i>Cap.</i>	<i>Descripción temas</i>	<i>pág.</i>
1	INFORMACIÓN GENERAL	5
1.1.	Finalidad del manual	5
1.2.	Símbolos	6
1.3.	Contenido del soporte digital	7
1.4.	Datos de identificación	8
2	INFORMACIÓN SOBRE LA SEGURIDAD	11
2.1.	Uso consentido del vehículo	11
2.2.	Mantenimiento	11
2.3.	Accesorios y modificaciones	12
2.4.	Carga vehículo	12
3	MANDOS Y INSTRUMENTOS	14
3.1.	Posición mandos y instrumentos	14
3.2.	Caballote lateral	16
3.3.	Mandos en el lado izquierdo del manillar	17
3.4.	Mandos en el lado derecho del manillar	19
3.5.	Interruptor encendido y bloqueo del manillar	22
3.6.	Mando cambio	26
3.7.	Instrumentos y testigos	27
3.7.1.	Testigos	28
3.7.2.	Display multi-función/Display marcha y temperatura del agua	29
3.8.	Tabla de lubricantes y líquidos	30

<i>Cap.</i>	<i>Descripción temas</i>	<i>pág.</i>
4	USO	31
4.1.	Uso de la motocicleta	31
4.2.	Rodaje	32
4.3.	Arranque del motor	34
4.4.	Selección y modificación funciones display	38
4.4.1.	Selección de las funciones de la pantalla	39
4.4.2.	Reset de las funciones cuenta kilómetros parciales	43
4.4.3.	Cambio de las unidades de medición	47
4.4.4.	Cronómetro	49
4.4.5.	Función TC	57
4.4.6.	Función IMMOBILIZER	58
4.4.7.	Selección del mapeado de la central	61
4.4.8.	Mensajes de advertencia/error	62
4.5.	Abastecimiento combustible	65
4.6.	Acceso al hueco portaobjetos	67
4.7.	Inactividad de la motocicleta	68
5	REGULACIONES	70
5.1.	Lista regulaciones	70
5.2.	Tabla de las regulaciones	73
5.3.	Regulación de la palanca del freno delantero	74
5.4.	Regulación de la palanca de embrague	74



ÍNDICE GENERAL

<i>Cap.</i>	<i>Descripción temas</i>	<i>pág.</i>
5.5.	Regulación de los espejos retrovisores	75
5.6.	Regulación de la suspensión delantera	76
5.6.1.	Precarga muelle	77
5.6.2.	Dispositivo hidráulico de frenado en extensión (suspensión delantera)	77
5.6.3.	Dispositivo hidráulico de frenado en compresión (suspensión delantera)	78
5.7.	Regulación de la suspensión trasera	79
5.7.1.	Dispositivo hidráulico de frenado en extensión (suspensión trasera)	80
5.8.	Ajuste proyector delantero	81



1.1. Finalidad del manual

El presente manual proporciona toda la información necesaria para un uso correcto y seguro de la moto.

Junto al manual se entrega también un “Quick Manual” de bolsillo, con una síntesis esencial de la información necesaria para el uso del vehículo.

El manual se entrega también en formato electrónico (.pdf) en este soporte digital, y puede ser impreso o visualizado en cualquier ordenador, ya sea en sistema Windows que Macintosh.

Le recomendamos leer atentamente el manual antes de utilizar la moto y cerciorarse de cualquier otra persona que la use haya hecho lo mismo.

Por último, le aconsejamos llevar siempre con Usted el “Quick Manual” y de rellenarlo con los datos identificativos suyos y de la motocicleta.



Copyright
MV AGUSTA Motor Spa
Todos los derechos reservados



1.2. Símbolos

Las partes del texto de particular importancia, correspondientes a la seguridad de la persona y a la integridad de la motocicleta, están evidenciadas con los siguientes símbolos:



Peligro - Atención: la falta o el incompleto cumplimiento de estas prescripciones puede comportar un grave peligro para su incolumidad o para la de otras personas.



Prudencia - Precaución: la falta o el incompleto cumplimiento de estas prescripciones puede comportar un riesgo de daños a la motocicleta.

Para indicar las personas autorizadas al desarrollo de las operaciones de ajustes y/o mantenimiento, las mismas se encuentran marcadas con los símbolos siguientes:



Información de las operaciones permitidas al motociclista.



Información de las operaciones que deben ser llevadas a cabo sólo por personal autorizado.

Para poner en evidencia ulteriores informaciones se utilizan los siguientes símbolos:



El símbolo  indica que es necesario utilizar una herramienta o utillaje específico para realizar correctamente la operación descrita.



El símbolo “§” indica que nos remitimos al capítulo indicado por el número que lo sigue.



1.3. Contenido del soporte digital

En el presente soporte digital Usted podrá encontrar, además de este manual, el Manual de Mantenimiento, el “Quick Manual” (del que también se entrega una versión impresa), la Guía de las Concesionarias, el Manual de garantía y el Catálogo de piezas especiales MV Agusta.

Al momento de la entrega de la motocicleta, su Concesionario le habrá entregado también el Certificado de Garantía y Pre-Entrega.

Le rogamos conservarlo junto con los documentos de la moto y los futuros cupones de mantenimiento que recibirá cada vez que realice las intervenciones programadas.

IMPORTANTE

La copia del Certificado de Garantía y Pre-entrega destinada a MV Agusta debe ser rellena por el Concesionario y devuelta a la fábrica dentro de 10 días a partir de la fecha de matriculación.

Las copias de los cupones de manutención recomendada deben ser rellenas siempre por los Concesionarios y devueltos a MV Agusta dentro de los 10 días siguientes a la fecha de la realización de las intervenciones.

**ES 1**

1.4. Datos de identificación

- 1) número de matrícula chasis
- 2) número de matrícula motor
- 3) datos de homologación

► Identificación motocicleta

La motocicleta está identificada por el número de matrícula del chasis. Para pedir piezas de recambio, además de este número, puede ser necesario indicar el número de matrícula del motor, el código del color y el número de identificación de la llave.

Se recomienda anotar los datos principales en los siguientes espacios.

BASTIDOR N.: _____

MOTOR N.: _____



► **Identificación de la llave de la motocicleta**

Se suministran dos llaves, una llave se utiliza sea para el arranque para accionar las cerraduras. Guarde en un lugar seguro la llave de reserva.

Tener conocimiento del número de identificación de la llave es indispensable en el caso sea necesario pedir un duplicado de la llave como recambio. El número de identificación de la llave esta impreso sobre la MV Code Card que viene junto con las llaves de arranque.

**1** ES

► **Identificación combinación colores motocicleta**

El código del color es indispensable para pedir las piezas de recambio de la carrocería. El mismo puede ser leído en la placa colocada en el lado inferior derecha del deposito gasolina.

Para acceder a la placa del código color, es necesario quitar el lateral deposito derecho. Saque la parte posterior del lateral deposito derecho según lo demostrado en la figura.

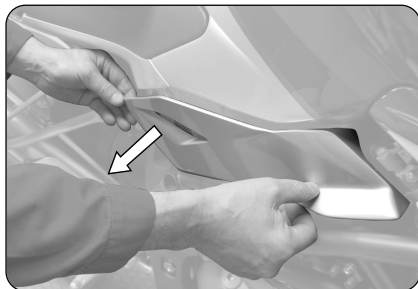

**ES 1**

Quite el lateral deposito derecho tirando de él hacia la parte posterior de la motocicleta.

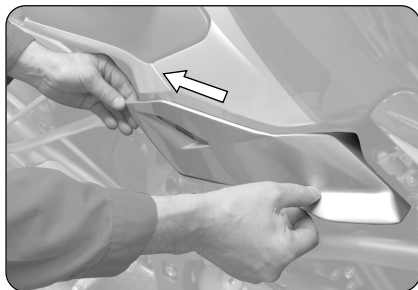

Después de haber quitado el lateral deposito izquierdo, se pueda ver la placa con el código color. En ésta placa es posible conocer el código del color de la motocicleta, el cual determina el color de las partes de la carrocería.

Se aconseja anotar el código color de la motocicleta en el espacio siguiente:

CÓDIGO COLOR :

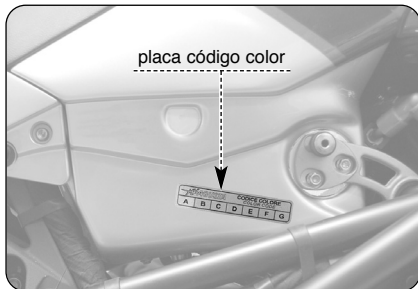



2.1. USO CONSENTIDO DEL VEHÍCULO

Su motocicleta ha sido proyectada para transitar exclusivamente por carreteras y autopistas.



ATENCIÓN

Saltuariamente es posible utilizar la motocicleta en pistas, pero en ocasiones que no prevean la competición. Sin embargo, a causa del mayor esfuerzo al que se somete la moto en tales ocasiones, en ese caso se recomienda hacer controlar las condiciones del vehículo por un Centro de Asistencia MV Agusta antes y después del uso. Cualquier otro uso está prohibido y expresamente excluido.

Para más información acerca del uso de la moto, consulte la sección 4 del presente manual.

2.2. MANTENIMIENTO

A fin de garantizar la máxima eficiencia y fiabilidad del vehículo, es esencial efectuar las intervenciones de mantenimiento previstas en el Manual de Mantenimiento.

MV Agusta recomienda que todas las operaciones de mantenimiento sean efectuadas exclusivamente por personal especializado perteneciente a un Centro de Asistencia MV Agusta.

En caso de que Usted decida efectuar las intervenciones de mantenimiento en otros talleres, deberá constatar que los mismos cuenten con la capacidad y los instrumentos específicos necesarios para la ejecución de tales operaciones.



ATENCIÓN

La garantía MV Agusta puede perder validez en caso de que otros talleres hayan efectuado intervenciones no conformes con las previstas en las Circulares Técnicas y los Manuales de Taller MV Agusta.



2.3. ACCESORIOS Y MODIFICACIONES



ATENCIÓN

MV Agusta prohíbe aportar cualquier tipo de modificación a sus motocicletas. Ello es necesario para tutelar la seguridad de sus Clientes.

De todos modos, Usted puede personalizar su motocicleta utilizando los artículos del vasto Catálogo de Accesorios MV Agusta.



ATENCIÓN

La instalación de algunos de estos accesorios puede invalidar la homologación de la moto y, por ende, comprometer su posibilidad de tránsito por las vías públicas.

En caso de dudas, le aconsejamos recurrir a su Concesionario MV Agusta de confianza para decidir cuáles son los accesorios más adecuados a sus propias exigencias.

2.4. CARGA DEL VEHICULO

El vehículo ha sido proyectado para ser usado por parte del piloto y de un eventual pasajero. Para utilizarlo en plena seguridad y respetando las normas del código de la circulación es obligatorio no superar nunca el peso bruto total máximo permitido del vehículo, el cual valor es indicado a continuación:

BRUTALE 990 R

Peso total máximo	370 kg
Peso de la carga máxima	180 kg

El peso total máximo representa la adición de los siguientes pesos, según la directiva CEE 92/61:

- peso de la motocicleta;
- peso del piloto;
- peso del pasajero;
- peso de la carga y de los accesorios.

**ATENCIÓN**

Considerado que la carga tiene una enorme importancia en la manejabilidad, la frenada, el rendimiento y las características de seguridad de vuestro vehículo, tener presente siempre las siguientes precauciones.

- **NO SOBRECARGAR NUNCA EL VEHICULO!** La utilización de una moto sobre cargada puede provocar daños a los neumáticos, pérdida del control o graves accidentes. Comprobar que el peso total del piloto, del pasajero, de la carga y de los accesorios no supere el peso máximo especificado para la moto.



3.1. Posición mandos e instrumentos

ES 3

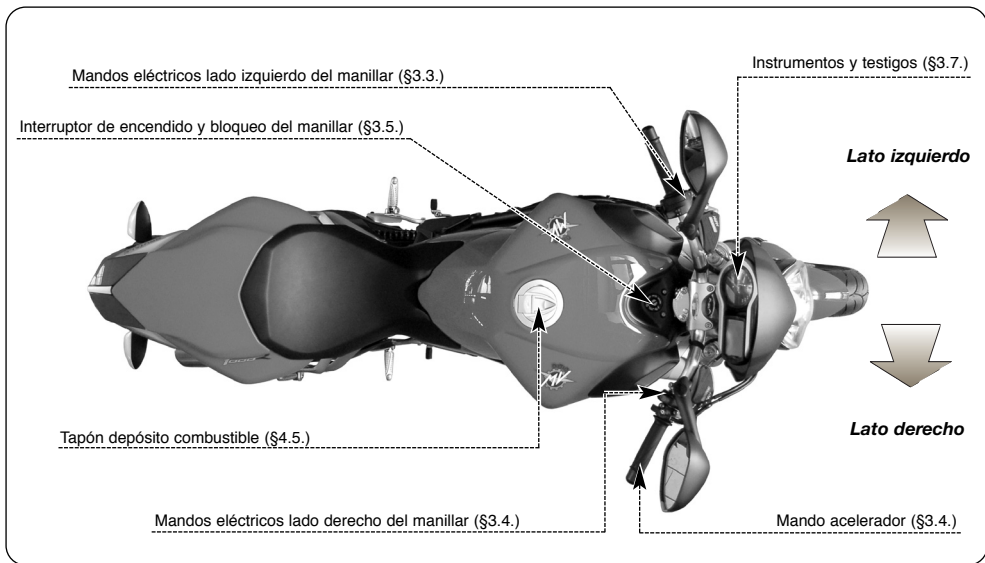

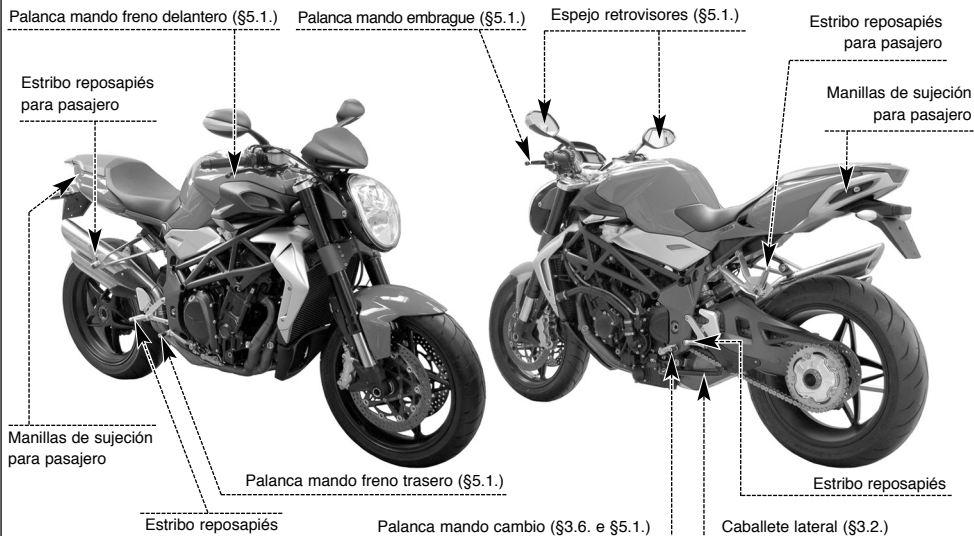



3.2. Caballete lateral

El caballete lateral está equipado con un interruptor de seguridad que impide a la moto de ponerse en marcha con el caballete bajado.

En el caso que con el motor en marcha y con el caballete bajado, se acciona el cambio para salir, el interruptor corta la corriente al motor provocando la parada.

En el caso que la moto se encuentre estacionada (con el caballete abajo) y con una velocidad engranada, el interruptor impide el arranque del motor evitando el peligro de caída accidental del vehículo.



Interruptor de seguridad

Caballete lateral

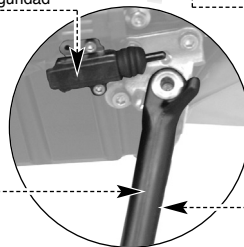

Caballete lateral

Doble muelle de retorno



3.3. Mandos lado izquierdo del manillar

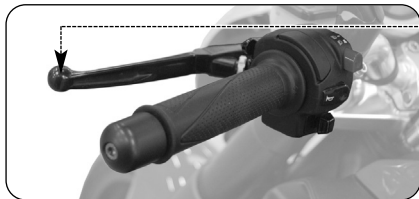

Palanca embrague

Acercar o alejar de la manecilla para accionar el embrague.

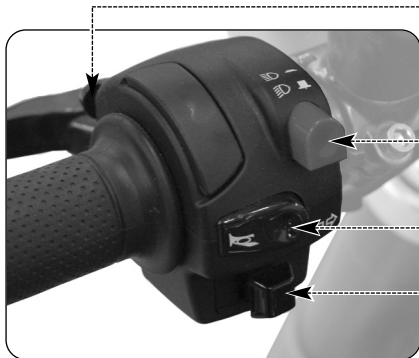

Pulsador centelleo faros

Apriete el pulsador repetidas veces.

Pulsador carretera/cruce

Pulsador hacia fuera  : cruce 

Pulsador hacia dentro  : carretera 

Pulsador claxon

Apriete para activar el claxon.

Palanca indicadores de dirección

Desplazando la palanca hacia la derecha o hacia la izquierda se activan los indicadores de dirección derechos o izquierdos. La palanca regresa al centro; apriete para desactivar los indicadores.



Pulsador Destello Faro

Esta función sirve para llamar la atención de los demás en el caso de posible situaciones de peligro; con la luz de carretera encendida dicha función no se activa.

Pulsador De carretera/De cruce

Normalmente es activada la función luz de cruce; cuando las condiciones del tráfico y de recorrido lo permiten, puede ser activada la función luz de carretera actuando en el pulsador.

Leva Indicadores de Dirección

Esta función permite señalar a los demás la intención de cambiar dirección o carril de marcha.



PELIGRO

No usar o no desactivar los indicadores de dirección en el momento oportuno puede provocar accidentes; los demás conductores podrían interpretar erróneamente el trayecto del vehículo. Accionar siempre los indicadores de dirección antes de girar o cambiar carril. Asegurarse después de desactivar los indicadores apenas efectuada dicha maniobra.

Pulsador del Claxon

Esta función sirve para llamar la atención de los demás conductores en el caso de posible condición de peligro.

Palanca Embrague

Esta palanca, a través de un dispositivo controlado hidráulicamente, permite accionar el embrague.



3.4. Mandos lado derecho del manillar

Palanca freno delantero

Acercarse a la manecilla para accionar el freno delantero.

Mando acelerador

Girar para regular la alimentación del motor.

Palanca arranque en frío del motor (Choke)

Gire en sentido horario para el arranque en frío del motor.
Pasados algunos segundos lleve la palanca a su posición inicial.

Interruptor stop motor

Si se acciona detiene el motor e impide su arranque.

Pulsador arranque motor

Apretado arranca el motor. Se debe soltar apenas arranca el motor. Con motor arrancado, apretándolo de nuevo, se seleccionan las funciones de la pantalla.

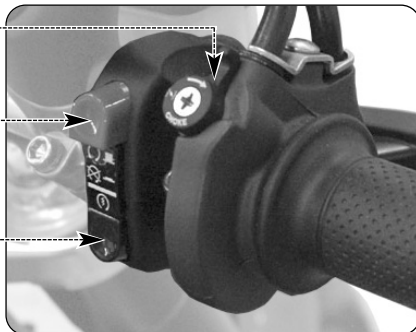
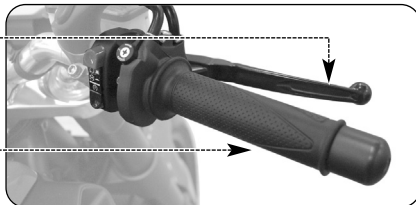



Interruptor Parada Motor

Esta función permite parar el motor en caso de emergencia; de ésta manera se desactiva el circuito de encendido impidiendo el arranque del motor. Para poder efectuar el arranque colocar nuevamente el pulsador en posición de descanso.

NOTA

En condiciones normales no utilizar éste dispositivo para parar el motor.

Pulsador Puesta en marcha del Motor

Este dispositivo permite la puesta en marcha del motor; además con el motor en marcha permite seleccionar las funciones del display presente en la instrumentación de a bordo.



PRUDENCIA - PRECAUCION

Para evitar daños a la instalación eléctrica no tener presionado el pulsador por mas de 5 segundos consecutivos.

Si el motor no arranca después de varios tentativos, consultar el capítulo “AVERÍAS” en éste manual.

Leva Puesta en marcha en frío del Motor (Choke)

El dispositivo facilita el arranque en frío actuando en la alimentación.

NOTA

Esta función debe estar activa por un tiempo limitado y de cualquier manera dependiendo de la temperatura del motor y del ambiente externo. Cuando el régimen de ralentí es suficiente para mantener prendido el motor, es oportuno desactivar el mando.



Mando Acelerador

Este dispositivo permite regular la alimentación del motor variando el régimen de rotación. Para accionar el dispositivo es necesario girar la manecilla en la posición de descanso, que corresponde al régimen de ralentí del motor.

Arrancando en frío (Choke activo), la rotación repetida de la manecilla hacia el cierre del gas permite retornar la leva del choke en posición de descanso.

Palanca Freno Delantero

Este mando permite accionar a través de un circuito hidráulico la instalación de frenos de la rueda delantera.



3.5. Interruptor de encendido y bloqueo del manillar



PELIGRO: No colocar llaveros u otros objetos en la llave de encendido para no crear obstáculos en la rotación de la dirección.



PELIGRO: No intentar cambiar la posición del interruptor durante la marcha; se podría perder el control del vehículo.

ES 3

Interruptor de encendido y bloqueo del manillar

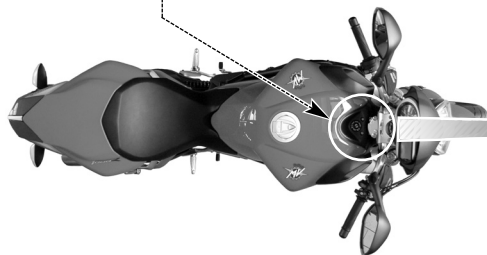

Posición "ON"

Posición "OFF"

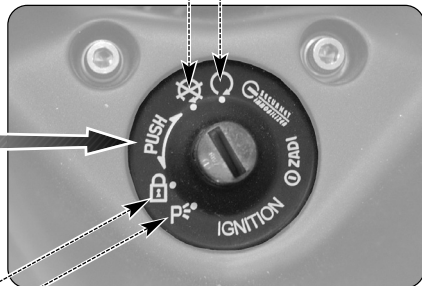

Posición "LOCK"

Posición "P"



El interruptor de encendido activa y desactiva el circuito eléctrico y el bloqueo del manillar; las cuatro posiciones de mando se describen a continuación.

Posición “OFF”

Todos los circuitos eléctricos están desactivados. Se puede extraer la llave.



Posición “ON”

Todos los circuitos eléctricos están activados, los instrumentos y los testigos efectúan el autodiagnóstico; se puede arrancar el motor. La llave no se puede extraer.



PRUDENCIA - PRECAUCION: No dejar la llave en la posición de “ON” por mucho tiempo con el motor apagado, para no dañar los componentes eléctricos de la motocicleta.



Posición "LOCK"

Gire el manillar a la derecha o a la izquierda. Empujar levemente la llave y al mismo tiempo girarla en posición "LOCK".

Todos los circuitos eléctricos están desactivados y el manillar está bloqueado. Se puede extraer la llave.

ES 3

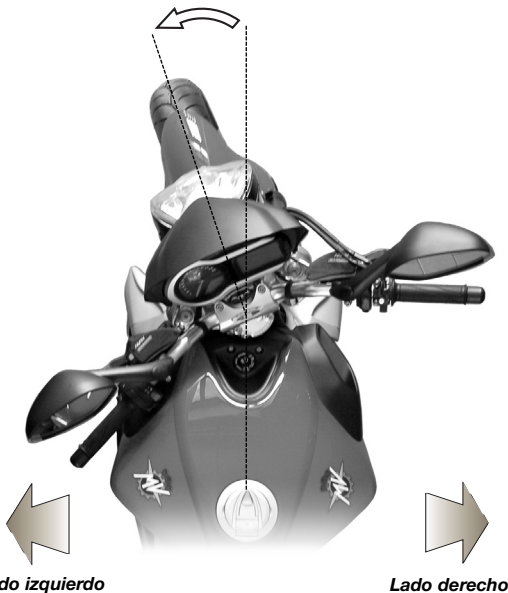
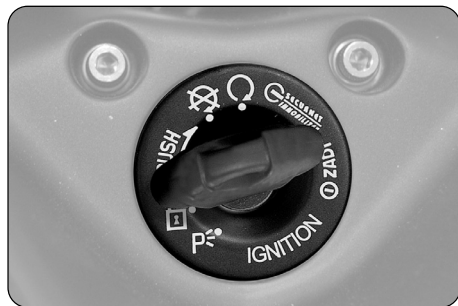



Posición “P”

Gire la llave de la posición “LOCK” a la posición “P”.

Todos los circuitos eléctricos están desactivados excepto las luces de estacionamiento (luces de posición) y el manillar está bloqueado. Se puede extraer la llave.



PRUDENCIA

No dejar la llave en posición “P” por mucho tiempo, para evitar descargar la batería de la motocicleta.



3.6. Mando cambio

La posición **N** "Neutral" corresponde a la posición de punto muerto señalada por el correspondiente testigo en el cuadro mandos.

Desplazando la palanca del cambio hacia abajo se engrana la primera velocidad.

De igual manera, desplazando la palanca hacia arriba se engrana la segunda; continuando varias veces a desplazar la palanca hacia arriba se engranan, en secuencia, todas las demás velocidades hasta la sexta.

ES 3



Palanca mando cambio

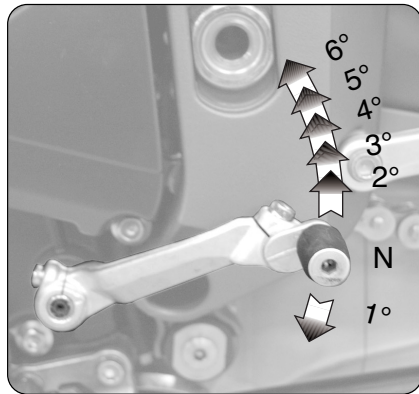



3.7. Instrumentación y testigos

Los instrumentos y los testigos se activan girando la llave de encendido a la posición "ON". Tras completar una secuencia de control preliminar (~ 7 segundos), podrá visualizar en el display los datos relativos a la condición general de la motocicleta.

Testigos (§3.7.1.)

Taquímetro

Display relación de marcha y temperatura del agua (§3.7.2.)

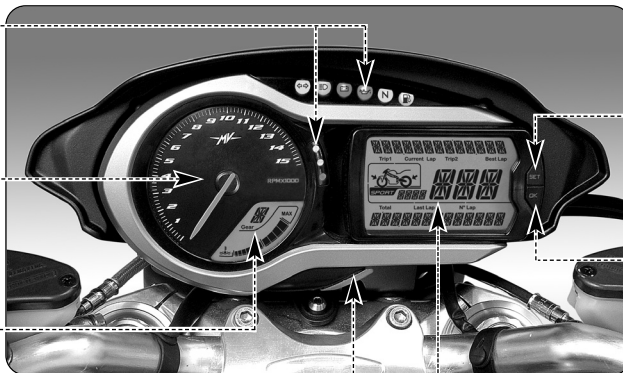

Pulsador "SET"
(§3.7.2.)

Pulsador "OK"
(§3.7.2.)

Tecla "HAZARD" (§3.7.2.)

Display multi-función (§3.7.2.)



3.7.1. Testigos

Luz larga (azul)

Se ilumina al encender la luz larga.

Presión de aceite del motor (rojo)

Se ilumina cuando la presión del aceite es insuficiente.



Peligro - Cuidado: Si se ilumina durante la marcha, deténgase inmediatamente, controle el nivel de aceite y diríjase a un Centro de Asistencia MV Agusta autorizado (ver §3.8) para solicitar el rellenado a nivel si fuera necesario. Si el piloto se enciende a pesar de que el nivel es correcto, detenga la motocicleta y contacte con un Centro de Asistencia MV Agusta autorizado.

Luces de giro (verde)

Se ilumina cuando se enciende algún indicador de giro.

Limitador de revoluciones (rojo)

Se ilumina cuando el motor excede las 11600 rpm.

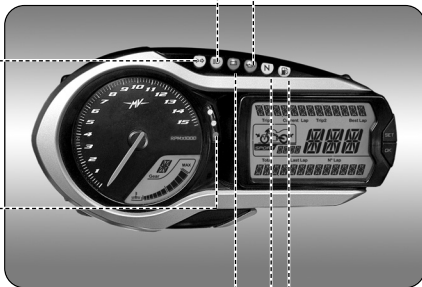

Carga batería (rojo)

Se ilumina cuando el alternador no genera una corriente suficiente para cargar la batería. Si este piloto se enciende durante la marcha, contacte con un Centro de Asistencia autorizado.

Testigo combustible (naranja)

Se ilumina cuando quedan aproximadamente 4 litros de combustible en el tanque.

Testigo cambio en punto muerto (verde)

Se ilumina cuando el cambio está en punto muerto ("Neutral").



3.7.2. Display multi-función/Display marcha y temperatura del agua

Display relación de marcha

Indica la relación correspondiente a la marcha embragada. La letra "N" ("Neutral") indica que el cambio se encuentra en punto muerto.

Termómetro

El número de segmentos iluminados sobre una escala graduada le permitirá conocer la temperatura del líquido refrigerante. Cuando la temperatura se encuentre fuera del intervalo de valores normales admisibles podrá visualizar una de las siguientes indicaciones:

- un solo segmento intermitente: temperatura baja;
- todos los segmentos iluminados y el segmento superior intermitente: temperatura alta.



Peligro - Cuidado: En caso de alta temperatura, detenga la motocicleta y controle el nivel del líquido refrigerante. Si debe rellenarse a nivel, diríjase a un Centro de Asistencia MV Agusta autorizado (ver § 3.8). Si la indicación persiste a pesar de que el nivel es correcto, detenga la motocicleta y contacte con un Centro de Asistencia MV Agusta autorizado.

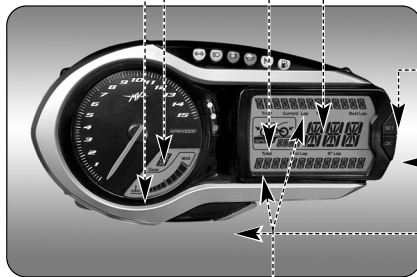

Modo "SPORT" Indica que se ha seleccionado el modo operativo "deportivo" de la central de inyección.

Velocímetro

Indica la velocidad en kilómetros por hora (Km/h) o en millas por hora (Mph). El máximo valor (fondo de escala) es de 320 Km/h (199 Mph).

Pulsador "SET"

Presionando esta tecla podrá seleccionar las cifras a programar desde el display.

Pulsador "OK" Presionando esta tecla podrá confirmar los valores seleccionados.

Pulsador "HAZARD"

Presionando esta tecla podrá activar las balizas.

Cuenta kilómetros total "TOTAL" Indica la distancia total recorrida; entre 0 y 999999 (Km o millas).

Cuenta kilómetros parcial 1 "TRIP 1" Indica la distancia parcial recorrida; entre 0 y 999.9 (Km o millas).

Cuenta kilómetros parcial 2 "TRIP 2" Indica la distancia parcial recorrida; entre 0 y 999.9 (Km o millas).

Cronómetro Indica los tiempos medidos con la función "Cronómetro".



3.8. Tabla lubricantes y líquidos

Descripción	Producto aconsejado	Características
Aceite lubricación motor	AGIP RACING 4T 10W/60 (*)	SAE 10W/60 - API SJ
Líquido de refrigeración	AGIP ECO - PERMANENT	Glicol - Etilénico diluido con 50% de agua destilada
Fluido mando embrague y frenos	AGIP BRAKE FLUID DOT4	DOT4
Aceite lubricación cadena	MOTUL CHAIN LUBE ROAD	-

* : Para encontrar fácilmente los productos recomendados, MV Agusta aconseja dirigirse directamente a los propios concesionarios autorizados. El aceite para motor AGIP Racing 4T 10W/60 ha sido realizado especialmente para el motor de la motocicleta Brutale. En el caso que el lubricante descrito no se consiga, MV Agusta aconseja utilizar aceites completamente sintéticos con características conformes o superiores a las siguientes normas:

- Conforme API SJ
- Conforme ACEA A3
- Conforme JASO MA
- Gradación SAE 20 W-50 o 10 W-60

NOTA

Las especificaciones indicadas deben estar presentes, por sí solas o junto a otras, en el envase del aceite lubricante.





4.1. Uso de la motocicleta

En esta sección se exponen los principales temas para el correcto uso de la motocicleta.



ATENCIÓN

Su motocicleta Brutale 990 R tiene altas características de potencia y prestaciones; por lo tanto, para su utilización es necesario un adecuado nivel de conocimiento del vehículo. Cuando usted utiliza la motocicleta para la primera vez, es necesario adoptar una actitud prudente. Una agresiva o temeraria actitud de conducción podría aumentar el peligro de accidentes y comportar un grave peligro para su incolumidad o para la de otras personas.



ATENCIÓN

LAS RESTRICCIONES DE USO DEL VEHÍCULO ESTÁN INDICADAS EN LA SECCIÓN “INFORMACIÓN PARA LA SEGURIDAD”.



4.2. Rodaje



Cautela - Precaución: No respetar las instrucciones que siguen puede resultar en deterioro de las prestaciones de su motocicleta y/o de su vida útil.

Es muy común pensar que la importancia del rodaje radique exclusivamente en el motor. En realidad, el rodaje es fundamental también para otros componentes vitales de la motocicleta como los neumáticos, los frenos y la cadena de transmisión, entre otros. Durante los primeros kilómetros conduzca con moderación.

Entre 0 y 500 Km (entre 0 y 300 millas) (A)

Varié frecuentemente el régimen del motor. Siempre que sea posible, recorra caminos con ligeras colinas y muchas curvas, evitando largos tramos rectilíneos.



CUIDADO

Los neumáticos deben someterse a un rodaje adecuado para poder responder eficientemente a las exigencias futuras. Evite aceleraciones, curvas y frenadas bruscas durante los primeros 100 km. Si los neumáticos no se someten a un correcto rodaje inicial, podrá enfrentarse al riesgo de resbalar y/o de perder el control del vehículo en el futuro, con el consiguiente peligro de accidentes.



Entre 500 y 1000 Km (entre 300 y 600 millas)

Evite someter el motor a esfuerzos prolongados.

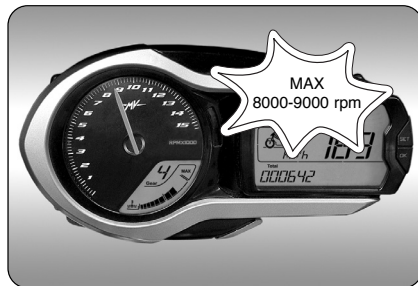

Entre 1000 y 2500 Km (entre 600 y 1600 millas)

Puede esperar una prestación mayor del motor sin por ello exceder el régimen indicado.

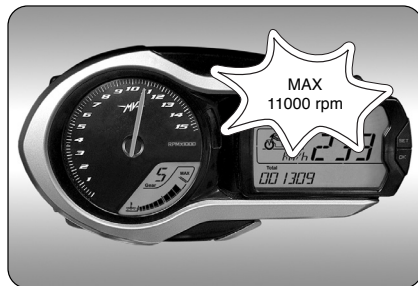



4.3. Arranque



CUIDADO

Dejar el motor en marcha en un ambiente cerrado puede ser peligroso. Los gases de escape contienen monóxido de carbono, un gas incoloro e inodoro que puede provocar la muerte o lesiones serias. Encienda y mantenga el motor en marcha sólo en lugares abiertos y/o al aire libre.



► Al girar el interruptor de encendido hasta la posición "ON", la instrumentación y los pilotos ejecutarán una secuencia de auto-diagnóstico preliminar: compruebe que se iluminen todos los pilotos del tablero durante esta inicialización.

► Para que el sistema del circuito de encendido genere la señal de arranque del motor deberá satisfacerse una de las siguientes condiciones:

- cambio en punto muerto y palanca de cambio en posición de embragado a fondo;
- una marcha embragada, palanca de cambio en posición de embragado a fondo y caballete lateral levantado.



► Si el auto-diagnóstico detecta la presencia de una avería en el vehículo, la pantalla muestra el mensaje de error mostrado en la figura. En particular, la pantalla muestra la parte del vehículo en el que se ha detectada la avería.



► Presionando ahora el pulsador "OK", se accede a la función "RUN".

**CUIDADO**

Si se detecta una avería en el vehículo, no arranque el motor y póngase en contacto con un centro de asistencia autorizado MV Agusta.





❑ Arranque en frío

▶ Gire la palanca "CHOKE" sin girar el mando del acelerador.

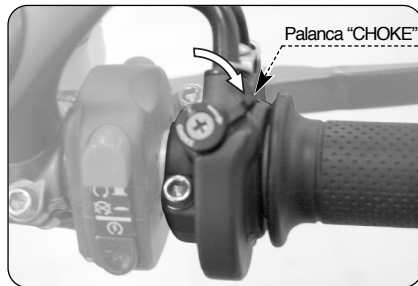

- ▶ Presione el botón para arrancar el motor.
- ▶ Suelte el botón apenas el motor se ponga en marcha y tras un breve calentamiento lleve la palanca "CHOKE" a su posición inicial. Gire el mando del acelerador.

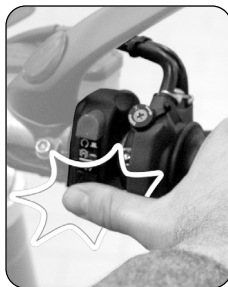



❑ Arranque en caliente

- ▶ Presione el botón para arrancar el motor sin girar el mando del acelerador.
- ▶ Suelte el botón apenas el motor se ponga en marcha.



Cautela - Precaución:

- **Nunca accione el arranque por más de 5 segundos consecutivos para evitar dañar la instalación eléctrica.**
- **Nunca deje el motor en marcha durante mucho tiempo con la motocicleta parada: pueden dañarse los componentes internos del motor debido al recalentamiento. Es preferible alcanzar la temperatura de régimen circulando a baja velocidad.**
- **Para prolongar el máximo posible la vida útil del motor, nunca acelere a fondo con el motor en frío.**





4.4. Selección y modificación de las funciones en el display

La instrumentación de su motocicleta le permite seleccionar y modificar algunos parámetros principales de medición tal como se describe a continuación:

- Selección de funciones :
 - “RUN” (Cuenta kilómetros)
 - “CHRONO” (Cronómetro)
 - “SERVICE” (Próximo mantenimiento programado)
 - “TC” (Control de tracción)
 - “IMMOBILIZER” (Sistema anti- robo)
- Reset de las funciones cuenta kilómetros parciales :
 - Cuenta kilómetros Parcial 1 “TRIP 1”
 - Cuenta kilómetros Parcial 2 “TRIP 2”
- Selección de las unidades de medición de:
 - Velocidad
 - Distancia recorrida
- Activación de la función cronómetro
- Selección del mapeado de la central *

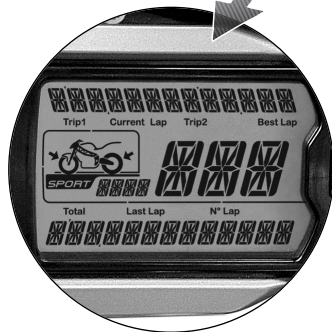

(*): Función disponible sólo en algunos modelos



4.4.1. Selección de las funciones en el display

Puede seleccionar las siguientes funciones:

- “RUN” (Cuenta kilómetros)
- “CHRONO” (Cronómetro)
- “SERVICE” (Próximo mantenimiento programado)
- “TC” (Control de tracción)
- “IMMOBILIZER” (Sistema anti-robo)

Presione la tecla “SET” menos de 4 segundos para poder visualizar las diversas funciones una a la vez. Si presiona la tecla por más de 4 segundos, visualizará todas las funciones, una luego de la otra. Seleccione la función deseada.

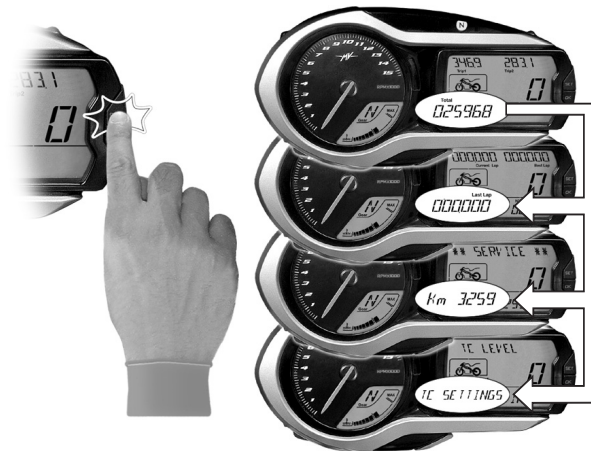

CUIDADO: Las funciones del display deben seleccionarse y modificarse con el motor apagado, en punto muerto, con la motocicleta detenida y los pies apoyados en el suelo. Queda terminantemente prohibido programar las funciones durante la marcha.



❑ Función “RUN”

Además de la función de taquímetro, podrá visualizar en el display las funciones que siguen (ver §4.4.2.):

- Cuenta kilómetros Total “TOTAL”
- Cuenta kilómetros Parcial 1 “TRIP 1”
- Cuenta kilómetros Parcial 2 “TRIP 2”

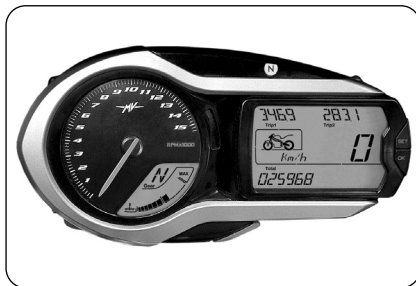

❑ Función “CHRONO”

Le permite activar el cronómetro y salvar los datos medidos (ver §4.4.4.). Las opciones visualizadas serán:

- Cronómetro Vuelta en curso “CURRENT LAP”
- Cronómetro Mejor vuelta recorrida “BEST LAP”
- Cronómetro Vuelta anterior “LAST LAP”
- Taquímetro Total de vueltas recorridas “N° LAP”





❑ Función “SERVICE”

Visualizará en el display el número de km que restan al próximo mantenimiento programado.

NOTA

Cuando la distancia en km que resta al próximo mantenimiento programado es menor de 1000 km, visualizará automáticamente el valor correspondiente apenas el sistema complete la secuencia de inicialización tras poner la motocicleta en marcha.

❑ Función “TC”

Le permite adaptar el nivel de control de la tracción del motor en función de sus exigencias de conducción (ver §4.4.5.).

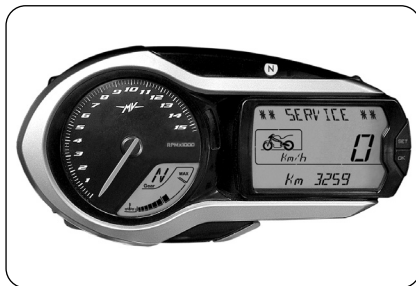



❑ Función “IMMOBILIZER”

Le permite poner el motor en marcha sólo si el sistema reconoce la llave de arranque original. Se trata de un sistema anti-robo integrado al circuito electrónico del vehículo que impide que una persona no autorizada la ponga en marcha. La función “IMMOBILIZER” debe utilizarse sólo en caso de anomalía: si por cualquier motivo el sistema no lograse reconocer la llave original, deberá introducir el código secreto indicado en la “MV Code Card” para que el sistema pueda generar la señal que consiente la puesta en marcha del motor (ver §4.4.6.).





4.4.2. Reset de las funciones cuenta kilómetros parciales

Para resetear las funciones “TRIP 1” y “TRIP 2” siga los pasos descritos a continuación.



CUIDADO

Las funciones del display deben seleccionarse y modificarse con el motor apagado, en punto muerto, con la motocicleta detenida y los pies apoyados en el suelo. Queda terminantemente prohibido programar las funciones durante la marcha.

- ▶ Seleccione la función “RUN” y presione “SET” por más de 4 segundos hasta visualizar “RUN MENU”.
- ▶ Presione “SET” menos de 4 segundos hasta visualizar “TRIP 1 RESET”.

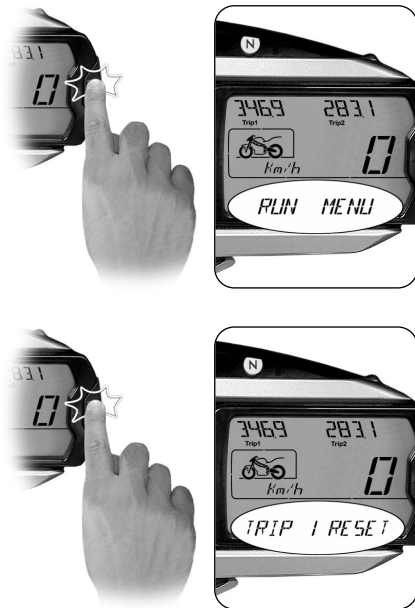



► Presione "OK" por más de 4 segundos: el valor "TRIP 1" pasará al estado intermitente.

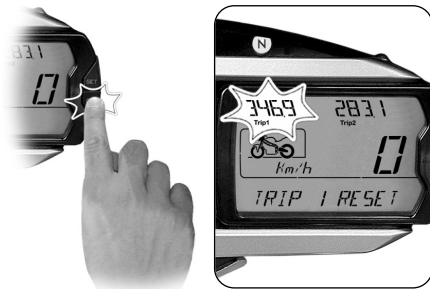

► Presione "OK" menos de 4 segundos para resetear el valor. Si presiona "SET" por más de 4 segundos, se interrumpirá la ejecución del reset.

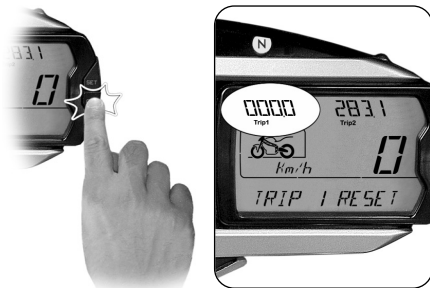



► Presione “SET” menos de 4 segundos hasta visualizar “TRIP 2 RESET”.

► Presione “OK” por más de 4 segundos: el valor “TRIP 2” pasará al estado intermitente.

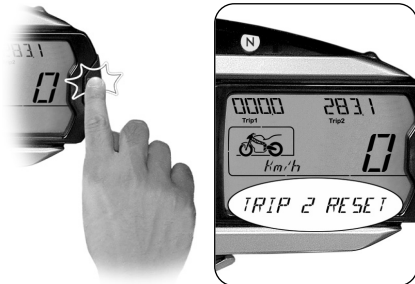



► Presione “OK” menos de 4 segundos para resetear el valor. Si presiona “SET” por más de 4 segundos, se interrumpirá la ejecución del reset.



► Presione nuevamente “OK” para salir de la función “TRIP 2 RESET” y pasar a la función sucesiva.





4.4.3. Cambio de las unidades de medición

Puede cambiar contemporáneamente las siguientes unidades de medición :

- Velocidad
- Distancia recorrida



CUIDADO

Las funciones del display deben seleccionarse y modificarse con el motor apagado, en punto muerto, con la motocicleta detenida y los pies apoyados en el suelo. Queda terminantemente prohibido programar las funciones durante la marcha.

- ▶ Seleccione la función "RUN" y presione "SET" varias veces hasta visualizar "UNIT CHANGE".
- ▶ Presione "OK" por más de 4 segundos: la unidad de medición del velocímetro pasará al estado intermitente.

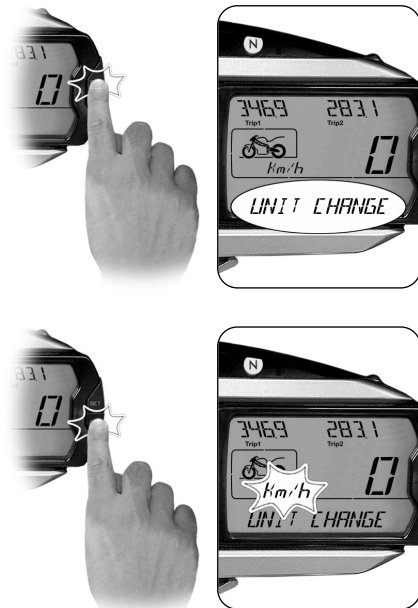



► Presione “OK” para pasar de Km/h a Mph o viceversa. Al cambiar la unidad de medición del velocímetro variarán automáticamente las siguientes unidades:

- Cuenta kilómetros (total y parcial): Km → millas

Si presiona “SET” por más de 4 segundos, se interrumpirá la ejecución del cambio de las unidades de medición.

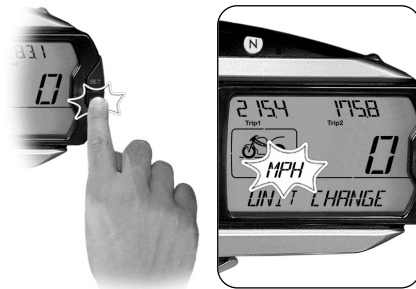

► Presione “OK” por más de 4 segundos para confirmar la configuración de las nuevas unidades de medición.



4.4.4. Cronómetro

❑ Adquisición de los tiempos de recorrido de la vuelta

▶ Active la función cronómetro (“CHRONO”) para que el sistema inicie a adquirir los datos correspondientes a los tiempos de recorrido de la vuelta.

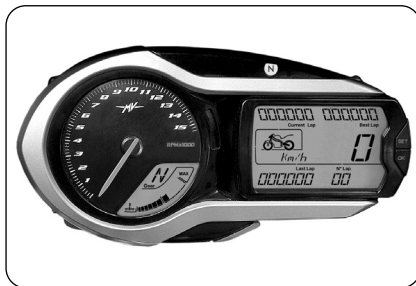

▶ Basta presionar el mando de la luz larga para que el sistema inicie la ejecución de la función: los dos puntos que separan los minutos, los segundos y las décimas de segundo pasan al estado intermitente, indicando que el sistema está adquiriendo los datos relativos a los tiempos.





► Presione nuevamente el mando de la luz larga para adquirir el tiempo correspondiente a la primera vuelta recorrida: el instrumento empezará a adquirir contemporáneamente el tiempo correspondiente a la segunda vuelta.

El tiempo medido que corresponde a la primera vuelta se salva en la memoria, visualizándose en el display como “LAST LAP” hasta que el sistema adquiera los datos de la vuelta sucesiva.

► Cada vez que presione el mando de la luz larga el sistema salvará un tiempo en su memoria. Este instrumento puede memorizar un máximo de 100 datos consecutivos.

Si el tiempo insumido para recorrer la vuelta que se ha apenas medido resulta menor que los tiempos medidos durante las vueltas anteriores, se salvará automáticamente este valor en la función “BEST LAP”, pudiéndose visualizar así el parámetro correspondiente a la mejor vuelta recorrida.





Visualización de datos

Una vez que el sistema haya completado la fase de adquisición de datos podrá visualizar los tiempos en el display.

► Seleccione la función “CHRONO” y presione “SET” por más de 4 segundos hasta visualizar “CHRONO MENU”.



CUIDADO:

Las funciones del display deben seleccionarse y modificarse con el motor apagado, en punto muerto, con la motocicleta detenida y los pies apoyados en el suelo. Queda terminantemente prohibido programar las funciones durante la marcha.

► Presione “SET” menos de 4 segundos hasta visualizar “LAPS VIEW”.

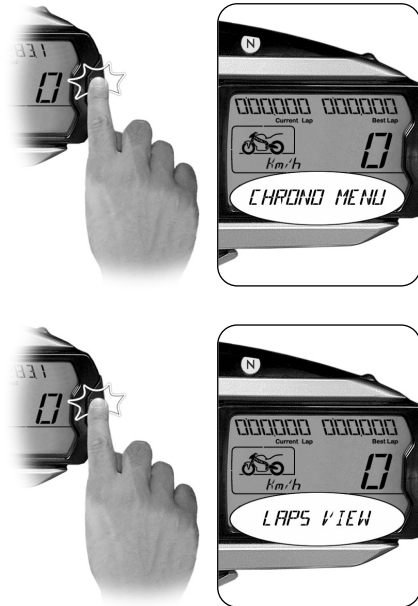



► Presione “OK” para visualizar el mejor tiempo de vuelta (“BEST LAP”) y las rpm correspondientes.

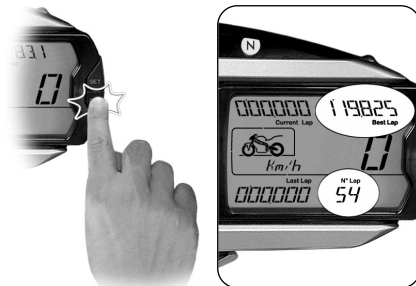

► A continuación, si presiona varias veces el mando de la luz larga, podrá visualizar en secuencia todos los tiempos adquiridos tras la primera vuelta.

► Tras visualizar todos los datos, presione “SET” para salir de la función “LAPS VIEW” y pasar a la sucesiva.

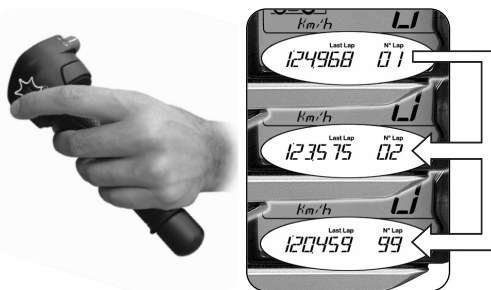



❑ Cómo borrar los datos

Para borrar los datos adquiridos siga los pasos descritos a continuación.

► Seleccione la función “CHRONO” y presione “SET” por más de 4 segundos hasta visualizar “CHRONO MENU”.



CUIDADO:

Las funciones del display deben seleccionarse y modificarse con el motor apagado, en punto muerto, con la motocicleta detenida y los pies apoyados en el suelo. Queda terminantemente prohibido programar las funciones durante la marcha.

► Presione SET” varias veces por menos de 4 segundos hasta visualizar “BEST LAP RESET”.

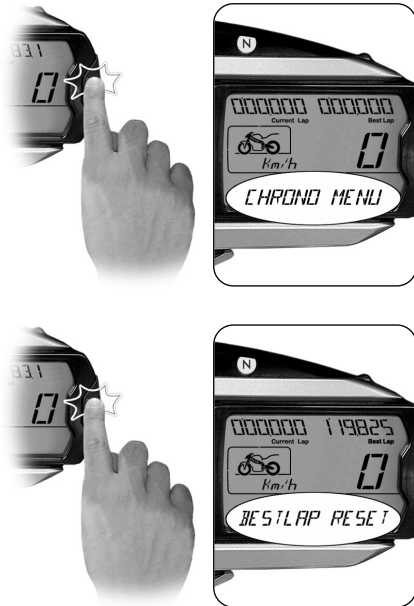



► Presione “OK” por más de 4 segundos: el valor “BEST LAP” pasará al estado intermitente.



► Presione “OK” menos de 4 segundos para borrar el dato. Si presiona “SET” por más de 4 segundos, se interrumpirá la ejecución de borrado.

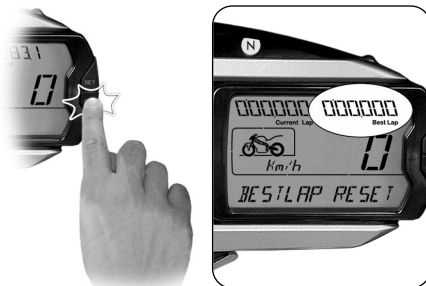



► Presione "SET" varias veces por menos de 4 segundos hasta visualizar "LAPS RESET".

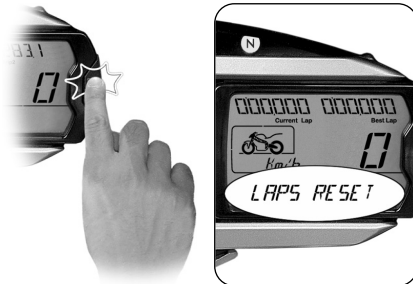

► Presione "OK" por más de 4 segundos: el valor "LAST LAP" pasará al estado intermitente.





► Presionando “OK” menos de 4 segundos podrá borrar todos los tiempos salvados en la memoria. Si presiona “SET” por más de 4 segundos, se interrumpirá la ejecución de borrado.



► Presione nuevamente “OK” para salir de la función “LAPS RESET” y volver a la función cronómetro.

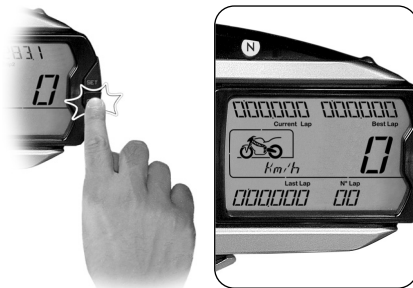



4.4.5. Función "TC"

► Presione "SET" para acceder a la función "TC", luego presione "SET" por más de 4 segundos hasta visualizar "TC LEVEL": el nivel de tracción efectivo corresponde al valor visualizado en el display.



CUIDADO:

Las funciones del display deben seleccionarse y modificarse con el motor apagado, en punto muerto, con la motocicleta detenida y los pies apoyados en el suelo. Queda terminantemente prohibido programar las funciones durante la marcha.

► Presione "OK" menos de 4 segundos: el nivel de control de la tracción aumenta hasta alcanzar el valor sucesivo. Intervalo de variación admisible: entre 0 y 8.

► Presione "OK" por más de 4 segundos para confirmar el nivel de control de tracción seleccionado.

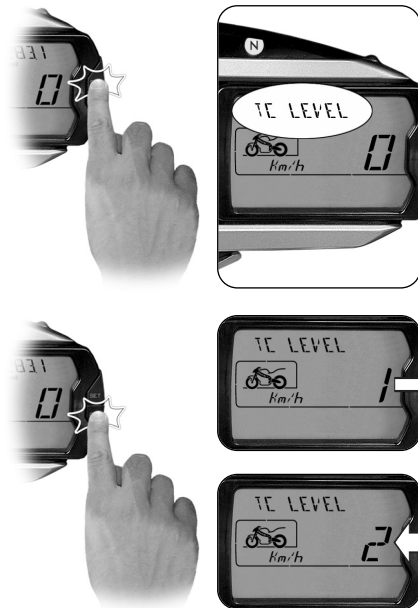



4.4.6. Función “IMMOBILIZER”

Ante una anomalía operativa, el sistema podría no reconocer el código de la llave de puesta en marcha, impidiéndole arrancar el motor. Para poder poner en marcha su motocicleta deberá introducir entonces el código secreto indicado en la “MV Code Card” entregada junto con el vehículo.

- ▶ Quite la cubierta del recuadro posterior de la “MV Code Card” y lea el código electrónico secreto de su llave de puesta en marcha (la figura indica un código indicativo que puede no corresponder al de su llave).
- ▶ Seleccione la función “IMMOBILIZER” y presione “SET” por más de 4 segundos hasta visualizar “INSERT CODE”.



CUIDADO

Las funciones del display deben seleccionarse y modificarse con el motor apagado, en punto muerto, con la motocicleta detenida y los pies apoyados en el suelo. Queda terminantemente prohibido programar las funciones durante la marcha.

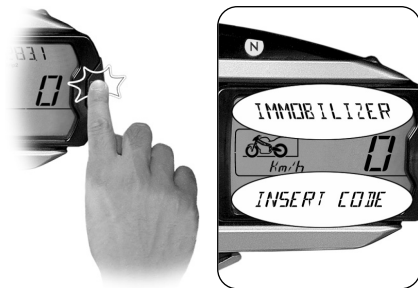



- ▶ Presione “SET” menos de 4 segundos para programar la primera cifra del código.
- ▶ Presionando “OK” menos de 4 segundos podrá modificar la primera cifra entre 0 y 9.

- ▶ Una vez que haya seleccionado la primera cifra presione “OK” por más de 4 segundos para confirmarla antes de pasar a la segunda.
- ▶ Repita estos pasos para introducir las 4 cifras restantes del código.

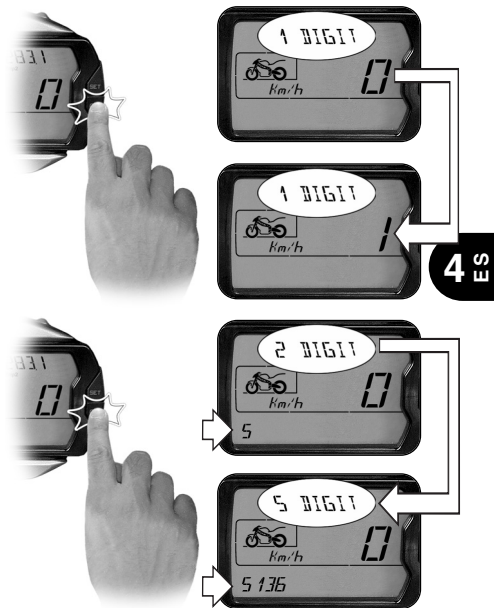



► Una vez que haya introducido todas las cifras del código visualizará en el display el mensaje “CONFIRM CODE”. Presione “OK” por más de 4 segundos para confirmar el código que ha introducido.

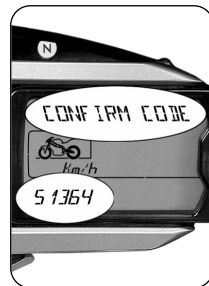

► Si el sistema reconoce el código, visualizará en el display el mensaje “VALID CODE”. El instrumento volverá entonces a la función “RUN”, permitiéndole arrancar el motor.

► Si el código introducido es incorrecto, visualizará en el display el mensaje “NOT VALID CODE”: el sistema no le permitirá arrancar el motor y volverá a la función “INSERT CODE”. Repita todos los pasos anteriores para introducir el código secreto correcto indicado en su MV Code Card. En caso de inconvenientes, contacte con un Centro de Asistencia MV Agusta autorizado.

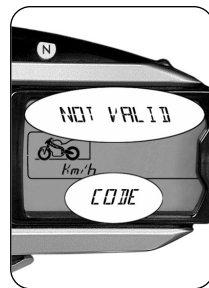
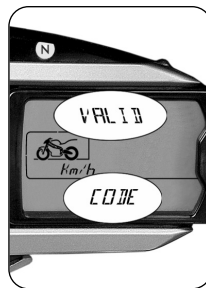



4.4.7. Selección del mapeado de la central *

Algunos modelos Brutale le permiten seleccionar un mapeado especial de la central para obtener una respuesta de potencia y una prestación particularmente deportivas de su motocicleta.

La selección del mapeado de la centralita se puede efectuar presionando el pulsador de arranque con motor encendido. Cuando se active el mapeado "deportivo" visualizará en el display el mensaje "SPORT".



CUIDADO:

El mapeado de la central se debe seleccionar tras arrancar el motor, en punto muerto, con la motocicleta detenida y los pies apoyados en el suelo. Queda terminantemente prohibido programar las funciones durante la marcha.

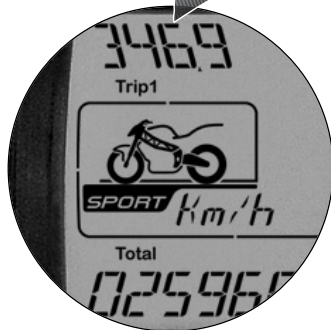

(*): Función disponible sólo en algunos modelos



4.4.8. Mensajes de advertencia/error

La pantalla puede mostrar un error o un mal funcionamiento en las diferentes condiciones de utilización del vehículo.

► *Arranque del motor:* Al girar el interruptor de encendido hasta la posición "ON", la instrumentación y los pilotos ejecutarán una secuencia de auto-diagnóstico preliminar. Si el auto-diagnóstico detecta la presencia de una avería en el vehículo, la pantalla muestra el mensaje de error mostrado en la figura. En particular, la pantalla muestra la parte del vehículo en el que se ha detectada la avería.

► Presionando ahora el pulsador "OK", se accede a la función "RUN".



CUIDADO

Si se detecta una avería con el vehículo parado, no arranque el motor y póngase en contacto con un centro de asistencia autorizado MV Agusta.





► *Marcha del vehículo:* Si se detecta una avería en la conducción del vehículo, la parte inferior de la pantalla muestra el mensaje de error mostrado en la figura.

**CUIDADO**

Si se detecta una avería en la marcha, detener el vehículo y póngase en contacto con un centro de asistencia autorizado MV Agusta.

► Cuando el vehículo está detenido, la pantalla muestra la parte del vehículo en el que se ha detectada la avería.





► *Alta temperatura del líquido refrigerante:* Si se detecta una alta temperatura del líquido refrigerante, la pantalla muestra el mensaje de error mostrado en la figura. Este mensaje puede aparecer durante todas las condiciones de uso del vehículo.

**CUIDADO**

En caso de alta temperatura, detenga la motocicleta y controle el nivel del líquido refrigerante. Si debe rellenarse a nivel, diríjase a un Centro de Asistencia MV Agusta autorizado (ver § 3.8). Si la indicación persiste a pesar de que el nivel es correcto, detenga la motocicleta y contacte con un Centro de Asistencia MV Agusta autorizado.





4.5. Abastecimiento combustible



Peligro – Atención: la gasolina y sus vapores son extremadamente inflamables y dañosos. Evitar el contacto y la inhalación.

Durante el abastecimiento apagar el motor, no fumar, tener lejos llamas, chispas y fuentes de calor. Efectuar el llenado en un lugar abierto o en un sitio bien ventilado.



Prudencia – Precaución: utilizar exclusivamente gasolina super sin plomo con 95 octanos (R.O.N.) o más. Esta necesidad es recordada por un punto verde en la parte inferior de la tapa del depósito.

- ▶ Levante la tapa parapolvero.
- ▶ Introduzca la llave, gírela en sentido horario.

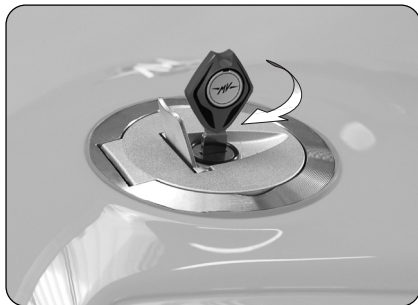
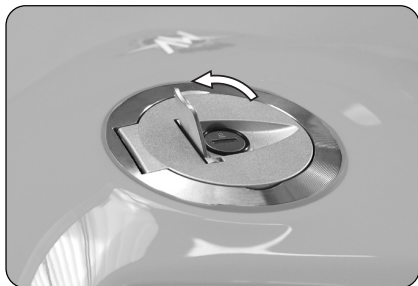



- ▶ Levantar la tapa y efectuar el abastecimiento de carburante.



PELIGRO: Llenando excesivamente el depósito puede provocar derrame del carburante debido a la expansión del calor provocada por el calor del motor o a la exposición de la motocicleta a la luz del sol. Eventual derrame de carburante puede provocar incendios. El nivel del carburante en el depósito no debe superar nunca la base de la boca de llenado.

- ▶ Después del abastecimiento presione el tapón hacia abajo girando contemporáneamente la llave en sentido horario para facilitar el cierre. Suelte la llave y extráigala.



Prudencia - Precaución: secar enseguida con un trapo limpio eventual carburante derramado, puesto que podría dañar la superficie pintada o de plástico.



PELIGRO: Verificar que la tapa del depósito del carburante esté cerrada correctamente antes de utilizar el vehículo.

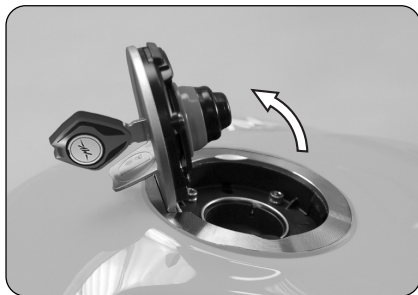



4.6. Acceso al hueco portaobjetos

- ▶ Introducir la llave en la cerradura.
- ▶ Girar la llave hacia la derecha y al mismo tiempo presionar levemente sobre el sillín piloto. Levantar y extraer el sillín.

Para montar nuevamente la pieza, seguir las siguientes indicaciones:

- Girar la llave en la cerradura
- Presionar el sillín piloto
- Soltar la llave
- Presionar nuevamente sobre el sillín cerciorándose que el mismo se encuentre muy bien enganchado a la estructura.

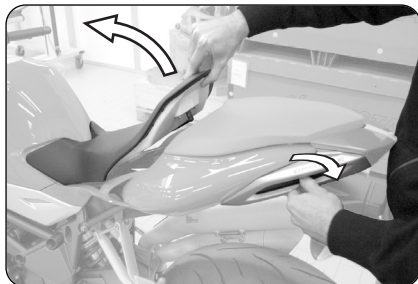

ATENCIÓN

Después de haber quitado y levantado el sillín piloto, y de todas maneras antes de utilizar la motocicleta, cerciorarse que el mismo haya sido colocado correctamente y que se encuentre bien sujeto a la estructura principal del vehículo.



4.7. Estacionamiento de la motocicleta

□ Estacionamiento con caballete lateral



ATENCIÓN

Aparcar la motocicleta en condiciones de seguridad y en un terreno estable. En las pendientes estacionar la moto con la rueda delantera hacia la subida y con la primera velocidad engranada; recordarse de retornar el cambio en neutro antes de poner en marcha el vehículo. No dejar el vehículo sin custodia con la llave de encendido introducida en el cuadro.

- ▶ Bajar el caballete con el pie hasta el tope e inclinar lentamente la motocicleta para colocar el pie de apoyo a contacto con el suelo.



Cuando el vehículo esté parado sobre el caballete lateral, es peligroso sentarse sobre él cargando todo el peso sobre el único apoyo de estacionamiento. Antes de ponerse en marcha verificar el buen funcionamiento del interruptor de seguridad cerciorandose que la luz testigo del caballete lateral ubicada en el tablero se apague; de todas maneras verificar que el caballete lateral haya retornado. Si se nota una imperfección, hacer controlar la instalación por un concesionario MV Agusta antes de utilizar el vehículo.



□ Estacionamiento con caballete trasero

Introducir el perno del caballete en el orificio del eje de la rueda trasera en el lado izquierdo de la moto; apoyar el caballete en el suelo y empujándolo, levantar el vehículo hasta que el vehículo esté estable.



ATENCIÓN

Esta operación se debe realizar por dos personas.

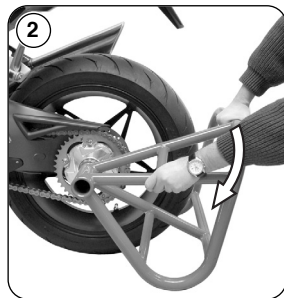
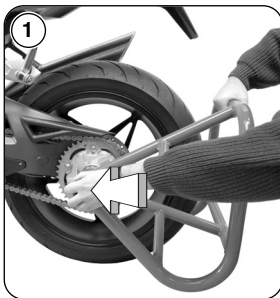



5.1. Lista regulaciones

La motocicleta posee una amplia posibilidad de regulaciones que pueden mejorar la ergonomía, la estabilidad y la seguridad.

Sin embargo algunas de estas regulaciones pueden ser realizadas exclusivamente por los Centros de Asistencia MV Agusta, dado que una regulación errónea de ciertos componentes sumamente importantes puede provocar una situación de peligro.



ATENCIÓN

Las regulaciones se deben realizar con el vehículo parado.



(E) Regulación espejo retrovisor (§5.5.)

(A) Regulación palanca
freno delantero (§5.3.)

(G) Regulación
suspensión trasera (§5.7.)

(D) Regulación palanca
freno trasero (§5.2.)

(F) Regulación suspensión
delantera (§5.6)

(L) Orientación
faro (§5.8.)

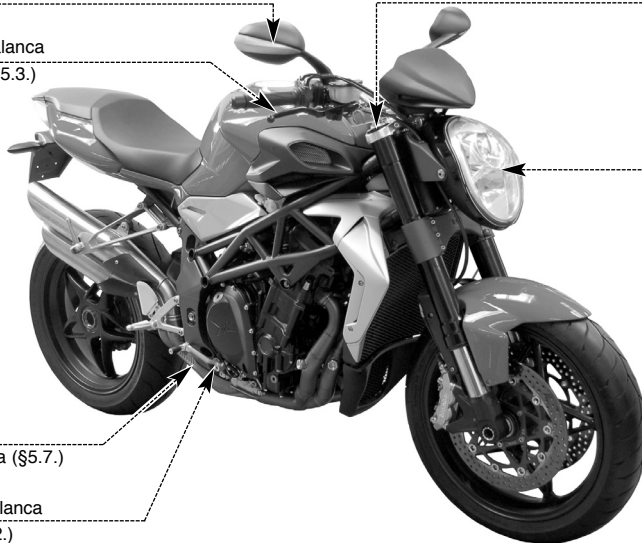



(E) Regulación espejo retrovisor (§5.5.)

(F) Regulación suspensión delantera (§5.6)

(B) Regulación palanca embrague (§5.4.)

(C) Regulación palanca cambio (§5.2.)

(H) Regulación cadena (§5.2.)

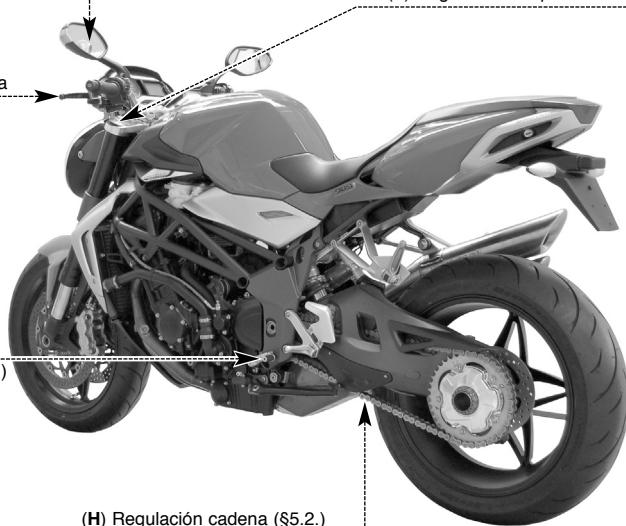



5.2. Tabla de las regulaciones

	A - Regulación palanca freno delantero: para optimizar el funcionamiento según las exigencias del motociclista (§5.3).	
	B - Regulación palanca embrague: para optimizar el funcionamiento según las exigencias del motociclista (§5.4).	
	C - Regulación palanca cambio: para optimizar el movimiento del mando en función de las exigencias del motociclista.	
	D - Regulación palanca freno trasero: para optimizar el movimiento de los mandos en función de las exigencias del motociclista.	
	E - Regulación espejos retrovisores: para optimizar la orientación (§5.5). ATENCIÓN: No intervenir en el tornillo de fijación del espejo retrovisor al manillar. En caso de necesidad, dirigirse a un concesionario MV Agusta.	
		F - Regulación suspensión delantera: para adaptar su respuesta a las preferencias del motociclista se pueden regular: <ul style="list-style-type: none">- precarga muelle (§5.6.1.)- dispositivo hidráulico de frenado en extensión (§5.6.2.)- dispositivo hidráulico de frenado en compresión (§5.6.3.)
		G - Regulación suspensión trasera: para adaptar su respuesta a las preferencias del motociclista se pueden regular: <ul style="list-style-type: none">- precarga muelle- altura rectificado- dispositivo hidráulico de frenado en extensión (§5.7.1.)
		H - Regulación cadena: para la eficacia y la seguridad de la transmisión.
		L - Orientación faro: para optimizar la profundidad del haz luminoso en función del equilibrado (§5.8).



5.3. Regulación de la palanca del freno delantero

Tire de la palanca para neutralizar el empuje del muelle y, contemporáneamente, ajuste la posición girando la virola en sentido horario o contrario a las agujas del reloj. En sentido horario: la palanca se aleja de la maneta. En sentido contrario a las agujas del reloj: la palanca se acerca a la maneta.

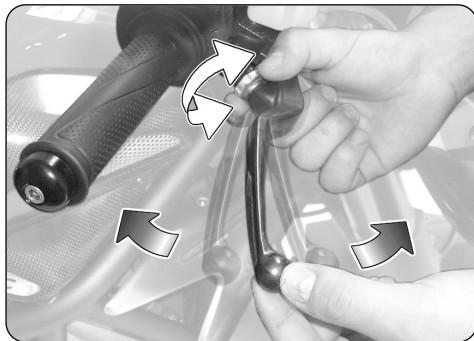

5.4. Regulación de la palanca del embrague

Tire de la palanca para neutralizar el empuje del muelle y, contemporáneamente, ajuste la posición girando la virola en sentido horario o contrario a las agujas del reloj. En sentido horario: la palanca se aleja de la maneta. En sentido contrario a las agujas del reloj: la palanca se acerca a la maneta.





5.5. Regulación de los espejos retrovisores

Apriete los puntos puestos en evidencia para regular la posición en las cuatro direcciones.

Efectuar el ajuste en ambos espejos retrovisores. Para realizar un óptimo ajuste, aconsejamos realizarlo subidos en el vehículo.

5
ES



5.6. Regulación de la suspensión delantera

NOTA

La regulación de las suspensiones se debe realizar preferiblemente con el depósito del combustible lleno.



Dispositivo hidráulico de frenado en extensión

Precarga muelle

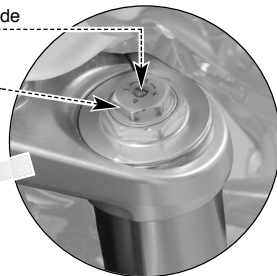

Dispositivo hidráulico de frenado en compresión

Precarga muelle

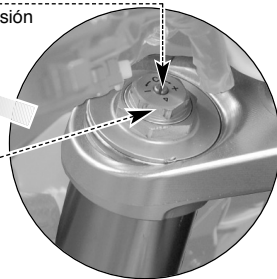



5.6.1. Precarga muelle

La regulación se debe efectuar partiendo de la posición standard. Para encontrar tal posición es necesario girar en sentido contrario a las agujas del reloj hasta el tope, después en sentido horario hasta la posición standard (véase tabla). Gire en sentido horario para aumentar la precarga muelle, o bien gire en sentido contrario a las agujas del reloj para disminuirla.



5.6.2. Dispositivo hidráulico de frenado en extensión (suspensión delantera)

La regulación se debe efectuar partiendo de la posición standard. Para encontrar tal posición es necesario girar en sentido horario hasta el tope, después en sentido contrario a las agujas del reloj hasta la posición standard (véase tabla). Gire en sentido horario para aumentar la acción de frenado, o bien gire en sentido contrario a las agujas del reloj para disminuirla.





5.6.3. Dispositivo hidráulico de frenado en compresión (suspensión delantera)

La regulación se debe efectuar partiendo de la posición standard. Para encontrar tal posición es necesario girar en sentido horario hasta el tope, después en sentido contrario a las agujas del reloj hasta la posición standard (véase tabla). Gire en sentido horario para aumentar la acción de frenado, o bien gire en sentido contrario a las agujas del reloj para disminuirla.





5.7. Regulación de la suspensión trasera



PELIGRO: la alta temperatura del tubo de escape puede provocar quemaduras. Apagar el motor y esperar que los tubos de escape se hayan enfriado antes de efectuar la regulación.
NOTA: La regulación de las suspensiones se debe realizar preferiblemente con el depósito del combustible lleno.



Dispositivo hidráulico de frenado en extensión



5.7.1. Dispositivo hidráulico de frenado en extensión (suspensión trasera)

El ajuste se debe realizar actuando en el tornillo que se encuentra en la parte inferior del amortiguador y partiendo de la posición estándar.

Para encontrar tal posición es necesario girar en sentido horario hasta el tope, después en sentido contrario a las agujas del reloj hasta que escuche el primer clic; luego girar en sentido contrario a las agujas del reloj hasta la posición standard (véase tabla).

Gire en sentido horario para aumentar la acción de frenado, o bien gire en sentido contrario a las agujas del reloj para disminuirla.

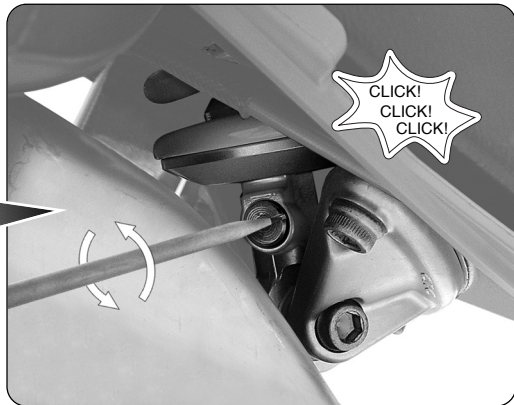



5.8. Ajuste proyector delantero

Colocar el vehículo a 10 metros de distancia de una pared vertical.

Asegurarse que el piso esté plano y que el eje óptico del proyector se encuentre perpendicular a la pared. El vehículo debe estar en posición vertical. Medir la altura del centro del proyector desde el suelo y marcar a esa altura la pared con una cruz.

Prendiendo la luz de cruce, el límite de demarcación entre la zona oscura y la zona iluminada debe resultar a una altura no superior a $9/10$ de la altura desde el suelo del centro del proyector.

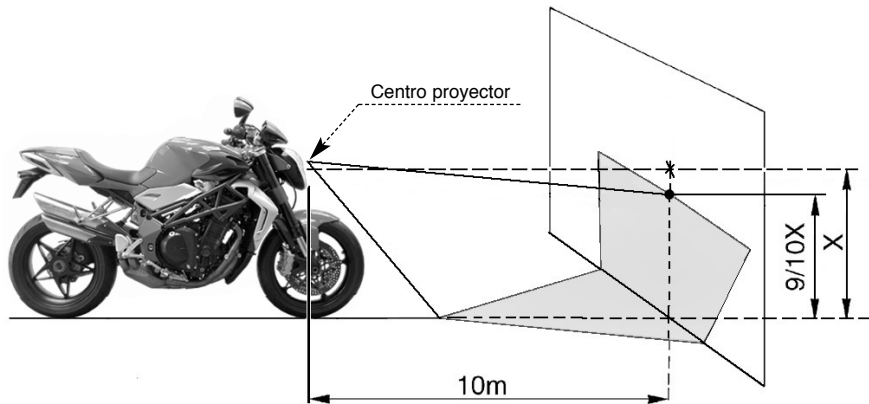



La regulación del faro delantero se puede realizar actuando en el tornillo que se muestra al lado. En sentido de las agujas del reloj: el faro se inclina hacia abajo. En sentido contrario a las agujas del reloj: el faro se inclina hacia arriba.

La inclinación se puede variar de $\pm 4^\circ$ respecto a la posición estándar.



ES 5



Nota informativa

MV Agusta S.p.A. está comprometida en una política de continuo mejoramiento de sus productos; por este motivo es posible encontrar ligeras diferencias entre el contenido de éste documento y el vehículo adquirido por Ustedes. Los modelos MV Agusta son exportados en muchos Países, en los cuales el Código del Transito y a los procedimientos de homologación son distintos a los nuestros.

Confiamos en Vuestra comprensión. MV Agusta S.p.A. considera por lo tanto necesario reservarse el derecho de aportar modificaciones a sus productos y a la documentación técnica en cualquier momento y sin ningún aviso previo.

Sugerimos para visitar a menudo el sitio Internet **www.mvagusta.it** para obtener informaciones y actualizaciones sobre los productos MV Agusta y la documentación relacionada.



Respetemos y defendamos el medioambiente

Todo lo que hacemos tiene repercusiones para todo el planeta y en sus recursos.

MV Agusta, a tutela de los intereses de la comunidad, sensibiliza los Clientes y los operadores de la asistencia técnica a adoptar una utilización del vehículo y de eliminación de sus partes, respetando plenamente las normativas vigentes en términos de contaminación del medio ambiente, eliminación y reciclaje de los desechos.

© 2010

Está prohibida la reproducción aunque sea parcial de éste documento sin el consentimiento escrito por MV Agusta S.p.A.

Part. n° 8000B3247

Edición n° 2 - Julio 2010



NOTAS

ES 5

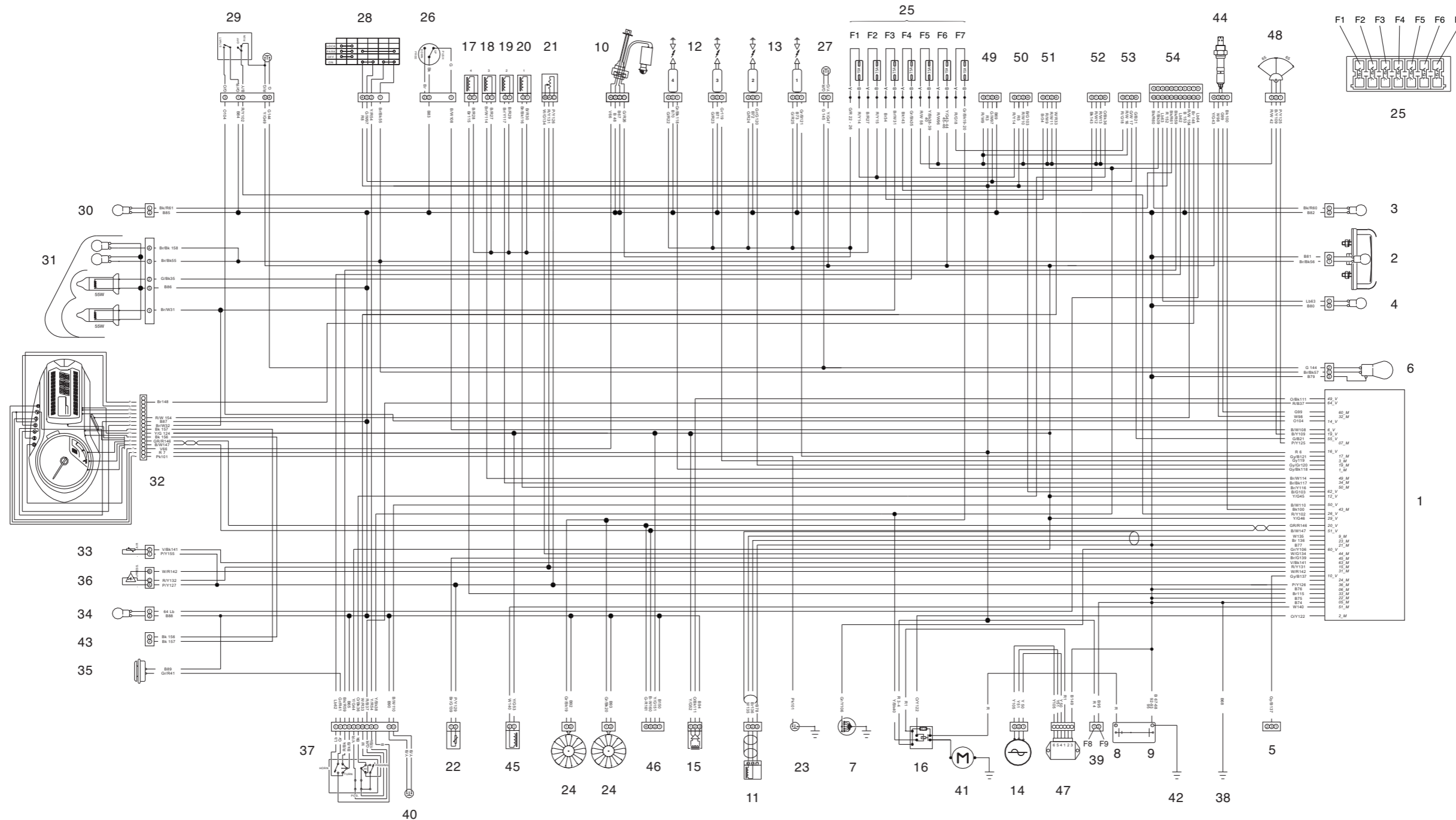

Legenda componenti	
Rif.	Descrizione
1	Centralina
2	Luce targa
3	Indicatore destro
4	Indicatore sinistro
5	Connettore diagnosi
6	Fanale posteriore - Stop
7	Interruttore folle
8-9	Batteria
10	Pompa - Sonda benzina
11	Sensore giri motore
12	Bobina
13	Bobina
14	Alternatore
15	Sensore velocità
16	Teleruttore
17-18	Iniettori
19-20	Iniettori

Legenda componenti	
Rif.	Descrizione
21	Potenziometro farfalla
22	Sensore temperatura acqua per centralina
23	Interruttore olio
24	Elettroventola
25	Fusibili
26	Interruttore stampella laterale
27	Interruttore stop posteriore
28	Interruttore chiave
29	Interruttore di sicurezza e stop anteriore
30	Indicatore destro
31	Fanale anteriore
32	Cruscotto
33	Sensore temperatura aria
34	Indicatore sinistro
35	Avvisatore acustico
36	Sensore pressione aria
37	Interruttore luci

Legenda componenti	
Rif.	Descrizione
38	Massa telaio - centralina
39	Ricarica batteria
40	Interruttore frizione
41	Motorino avviamento
42	Massa telaio
43	Antenna Immobilizer
44	Sonda lambda
45	Elettrovalvola
46	Sensore pressione/temperatura pneumatici
47	Regolatore di tensione
48	Interruttore di caduta
49	Relé generale
50	Relé iniezione
51	Relé faro abbagliante
52	Relé faro anabbagliante
53	Relé elettroventole
54	Relé intermittenza

Legenda colori cavi	
Lettera/e	Colore
R	Rosso
Y	Giallo
B	Blu
G	Verde
W	Bianco
Bk	Nero
P	Rosa
V	Viola
Sb	Azzurro
Gr	Grigio
O	Arancio
Br	Marrone

Nei colori combinati è indicato il colore di fondo e la marcatura. Es.: Br/Bk.

Legenda fusibili		
Rif.	Amperaggio (A)	Utilizzo
F1	15	Pompa benzina - Bobine
F2	7.5	Iniettori
F3	7.5	Faro abbagliante
F4	7.5	Faro anabbagliante
F5	7.5	Relé avviamento - Indicatori di direzione - Avvisatore acustico
F6	15	Fanale posteriore-stop - Sonda Lambda - Cruscotto - Sensore velocità - Solenoide valvola aria secondaria - Luci di posizione - Centralina
F7	15	Elettroventole
F8	40	Ricarica batteria
F9	40	Scorta per ricarica batteria

Parts list	
Ref.	Description
1	Power unit
2	Plate light
3	Turn indicator, right hand
4	Turn indicator, left hand
5	Diagnosis connector
6	Brake light
7	Neutral switch
8-9	Battery
10	Pump - Low fuel probe
11	Engine rpm sensor
12	Coil
13	Coil
14	Alternator

Parts list	
Ref.	Description
15	Speed sensor
16	Solenoid starter
17-18	Injectors
19-20	
21	Throttle potentiometer
22	Water temperature sensor for power unit
23	Oil switch
24	Heater fan
25	Fuses
26	Side stand switch
27	Rear brake switch
28	Key switch
29	Safety and front brake switch

Parts list	
Ref.	Description
30	Turn indicator, right hand
31	Front light
32	Display
33	Air temperature sensor
34	Turn indicator, left hand
35	Horn
36	Air pressure sensor
37	Light switch
38	Frame - power unit ground
39	Battery recharge
40	Clutch switch
41	Starter
42	Frame ground

Parts list	
Ref.	Description
43	Immobilizer Antenna
44	Lambda sensor
45	Electrovalve
46	Tyre pressure and temperature sensor
47	Voltage regulator
48	Tilt sensor
49	Main relay
50	Injection relay
51	High beam relay
52	Low beam relay
53	Relay for electric fan
54	Turn signal relay

Wire colors list	
Letter(s)	Color
R	Red
Y	Yellow
B	Blue
G	Green
W	White
Bk	Black
P	Pink
V	Violet
Sb	Sky blue
Gr	Grey
O	Orange
Br	Brown

In combined colors, background and marking colors have been pointed out. E.g. : Br/Bk.

Fuses list		
Ref.	Amperage (A)	Application
F1	15	Fuel pump - Coils
F2	7.5	Injectors
F3	7.5	High beam
F4	7.5	Low beam
F5	7.5	Starter relay - Turn indicators - Horn
F6	15	Tail light- Lambda sensor- Display - Speed sensor - Solenoid secondary air valve - Position lights - Power unit
F7	15	Electric fans
F8	40	Battery recharge
F9	40	Battery recharge supply

Légende des composants	
Réf.	Description
1	Boîtier d'allumage
2	Eclaireur de plaque
3	Clignotant D
4	Clignotant G
5	Connecteur doagnostic
6	Feu arrière "Stop"
7	Contacteur de point mort
8-9	Batterie
10	Pompe - Sonde essence
11	Capteur compte tours
12	Bobine
13	Bobine
14	Alternateur

Légende des composants	
Réf.	Description
15	Capteur de vitesse
16	Télérupteur
17-18	Injecteurs
19-20	
21	Centrale clignotante
22	Capteur de température d'eau pour boîtier
23	Manocontact d'huile
24	Electrovanne
25	Fusibles
26	Contacteur de béquille latérale
27	Contacteur de stop arrière
28	Contacteur principal à clé
29	Contacteur de sûreté et stop avant

Légende des composants	
Réf.	Description
30	Clignotant D.
31	Feu avant
32	Tableau de bord
33	Capteur pour temperature air
34	Clignotant G.
35	Avertisseur sonore
36	Capteur pour pression air
37	Contacteur d'éclairage
38	Masse cadre - boîtier
39	Charge batterie
40	Contacteur embrayage
41	Démarré électrique
42	Masse au cadre

Légende des composants	
Réf.	Description
43	Antenne systeme antidemarrage el.
44	Sonde Lambda
45	Electro-vanne
46	Capteur de pression et temperature pneus
47	Régulateur de tension
48	Sonde d'inclinaison
49	Relais general
50	Relais injection
51	Relais feu de route
52	Relais feu de croisement
53	Relais pour electro-ventilateur
54	Relais intermittence

Légende couleur des câbles	
Lettre(s)	Couleur
R	Rouge
Y	Jaune
B	Bleu
G	Vert
W	Blanc
Bk	Noir
P	Rose
V	Violet
Sb	Bleu ciel
Gr	Gris
O	Orange
Br	Marron

Pour les couleurs combinés, la couleur de fond et le marquage sont indiqués. Par ex. Br/Bk.

Légende des fusibles		
Réf.	Ampérage (A)	Emploi
F1	15	Pompe à carburant - Bobines
F2	7.5	Injecteurs
F3	7.5	Feu de route
F4	7.5	Feu de croisement
F5	7.5	Relais démarrage - Clignotants - Avertisseur acoustique
F6	15	Feu arrière-stop - Sonde Lambda - Tableau de bord - Capteur de vitesse - Solenoïde soupape air secondaire - Feu de position - Unité de commande
F7	15	Electroventilateurs
F8	40	Charge batterie
F9	40	Réserve recharge batterie

Zeichenerklärung Bauteile	
Rif.	Beschreibung
1	Zündbox
2	Nummernschildbeleuchtung
3	Rechter Blinker
4	Linker Blinke
5	Diagnoseanschluß
6	Rücklicht - Bremslicht
7	Schalter Leerlauf
8-9	Batterie
10	Pumpe - Benzinstandgeber
11	Sensor Motordrehzahl
12	Spule
13	Spule
14	Lichtmaschine

Zeichenerklärung Bauteile	
Rif.	Beschreibung
15	Geschwindigkeitssensor
16	Fernrelais
17-18	Einspritzdüsen
19-20	
21	Potentiometer Drosselventil
22	Temperaturfühler Wassertemperatur für Kontrollbox
23	Öldruckschalter
24	Gebälse
25	Sicherungen
26	Schalter Seitenständer
27	Hinterer Bremslichtschalter
28	Zündschloß
29	Sicherheitsschalter und vorderer Bremslichtschalter

Zeichenerklärung Bauteile	
Rif.	Beschreibung
30	Rechter Blinker
31	Vorderer Scheinwerfer
32	Armaturenbrett
33	Sensor für Temperatur von Luft
34	Linker Blinker
35	Hupe
36	Drucksensor von Luft
37	Lichtschalter
38	Masse Rahmen - Kontrollbox
39	Batterieladung
40	Kupplungsschalter
41	Anlassermotor
42	Masse Rahmen

Zeichenerklärung Bauteile	
Rif.	Beschreibung
43	Immobilizer -Antenna
44	Lambdasonde
45	Elektroventil
46	Reifendruck-und-temperatur sensor
47	Spannungs- Regler
48	Neigung-Sensor
49	Hauptrelais
50	Einspritzrelais
51	Relais für fernlicht
52	Relais für abblendlicht
53	Relais für Kühlungsflügel
54	Relais für intermittenz

Zeichenerklärung Kabelfarben	
Buchstabe(n)	Farbe
R	Rot
Y	Gelb
B	Blau
G	Grün
W	Weiß
Bk	Schwarz
P	Rose
V	Violett
Sb	Hellblau
Gr	Grau
O	Orange
Br	Braun

Bei Farbkombinationen wird die Grundfarbe und die Markierung angegeben. Z. B. Br/Bk.

Zeichenerklärung Sicherungen		
Nr.	Ampereleistung (A)	Einsatz
F1	15	Benzinpumpe - Spulen
F2	7.5	Einspritzventile
F3	7.5	Fernlicht
F4	7.5	Abblendlicht
F5	7.5	Startrelais - Blinkern - Hupe
F6	15	Rückleuchte-stop - Lambda-sonde - Armaturenbrett - Geschwindigkeitssensor- Magnetventil nebenluft - Standlicht - Zündbox
F7	15	Elektroluterrad
F8	40	Batterieladung
F9	40	Ersatz für Batterieladung

Leyenda Componentes	
Ref.	Descripción
1	Central
2	Luz matrícula
3	Indicador derecho
4	Indicador izquierdo
5	Conector diagnóstico
6	Faro trasero - Stop
7	Interruptor punto muerto
8-9	Batería
10	Bomba - Sonda gasolina
11	Sensor revoluciones motor
12	Bobina
13	Bobina
14	Alternador

Leyenda Componentes	
Ref.	Descripción
15	Sensor velocidad
16	Teleruptor
17-18	Inyectores
19-20	
21	Potenciómetro mariposa
22	Sensor temperatura agua para central
23	Interruptor aceite
24	Electroventilador
25	Fusibles
26	Interruptor pata lateral
27	Interruptor stop trasero
28	Interruptor llave
29	Interruptor de seguridad y stop delantero

Leyenda Componentes	
Ref.	Descripción
30	Indicador derecho
31	Faro delantero
32	Cuadro mandos
33	Sensor temperatura aire
34	Indicador izquierdo
35	Claxon
36	Sensor presión aire
37	Interruptor luces
38	Masa chasis - central
39	Recarga batería
40	Interruptor embrague
41	Motor de arranque
42	Masa chasis

Leyenda Componentes	
Ref.	Descripción
43	Antena Immobilizer
44	Sonda Lambda
45	Electroválvula
46	Sensor de presión y temperatura neumáticos
47	Regolador de tensión
48	Sensor de la inclinación
49	Relé general
50	Relé inyección
51	Relé luz de carretera
52	Relé luz de cruce
53	Relé por electroventilador
54	Relé intermitencia

Leyenda colores cables	
Letra/s	Color
R	Rojo
Y	Amarillo
B	Azul marino
G	Verde
W	Blanco
Bk	Negro
P	Rosa
V	Violeta
Sb	Azul
Gr	Gris
O	Naranja
Br	Marrón

En los colores combinados se indica el color de fondo y la marcación Ej. Br/Bk.

Leyenda fusibles		
Ref.	Amperaje (A)	Utilización
F1	15	Bomba carburante - Bobinas
F2	7.5	Inyectores
F3	7.5	Luz de carretera
F4	7.5	Luz de cruce
F5	7.5	Relé de arranque - Indicadores de dirección - Claxon
F6	15	Piloto-stop - Sonda Lambda - Cuadro mandos - Sensor velocidad - Solenoide válvula aire secundario - Luz de posición - Central
F7	15	Electroventiladores
F8	40	Recarga batería
F9	40	Repuesto recarba batería

IT Fase 1: Effettuare la carica iniziale della batteria secondo le istruzioni riportate nella rispettiva confezione.

Fase 2: Inserire la chiave della motocicletta nella serratura posteriore. Ruotare la chiave in senso orario e contemporaneamente sollevare la sella pilota come mostrato in figura.

Fase 3: Inserire la batteria nell'apposito vano.

Fase 4: Montare il terminale positivo (+) sul relativo polo della batteria rispettando la posizione indicata in figura.

Fase 5: Ruotare la vite del terminale positivo ed effettuare il serraggio ad una coppia pari a $7 \div 8 \text{ Nm}$.

Fase 6: A montaggio avvenuto sistemare la **cuffia di protezione** sul polo positivo (vedi figura).

Fase 7: Montare i 2 terminali negativi (-) sul relativo polo della batteria rispettando la disposizione mostrata in figura.

Fase 8: Ruotare la vite dei terminali negativi ed effettuare il serraggio ad una coppia pari a $7 \div 8 \text{ Nm}$.

Fase 9: Rimontare la sella pilota seguendo in senso inverso le operazioni descritte nella fase 2.

GB Phase 1: Perform the initial charge of the battery according to the instruction sheet enclosed in its package.

Phase 2: Insert the motorcycle key in the rear lock. Rotate the key clockwise while lifting the rider's saddle as shown in the picture.

Phase 3: Insert the battery in its proper compartment.

Phase 4: Fit the positive terminal (+) on the corresponding battery pole, respecting the position shown in the figure.

Phase 5: Rotate the positive terminal screw and tighten it at a torque equal to $7 \div 8 \text{ Nm}$.

Phase 6: Afterwards, fit the **protective cap** on the positive pole (see figure).

Phase 7: Fit the 2 negative terminals (-) on the corresponding battery pole, respecting their disposition as shown in the figure.

Phase 8: Rotate the negative terminal screw and tighten it at a torque equal to $7 \div 8 \text{ Nm}$.

Phase 9: Replace the rider's saddle by inversely performing the operations described in the phase 2.

FR Etape 1: Exécutez la charge initiale de la batterie selon les instructions incluses en son paquet.

Etape 2: Introduire la clé de la motocyclette dans la serrure postérieure. Tourner la clé dans le sens des aiguilles d'une montre et simultanément soulever la selle du pilote comme montré en figure.

Etape 3: Introduire la batterie dans son compartiment.

Etape 4: Monter le borne positif (+) sur le pôle correspondant de la batterie en respectant la position indiqué dans la figure.

Etape 5: Tourner la vis du borne positif et la serrer à un couple égal à $7 \div 8 \text{ Nm}$.

Etape 6: Une fois le montage accompli, placer le **protecteur** sur le pôle positif (voir figure).

Etape 7: Monter les 2 bornes négatives (-) sur le pôle correspondant de la batterie en respectant la disposition indiquée sur la figure.

Etape 8: Tourner la vis des bornes négatives et la serrer à un couple égal à $7 \div 8 \text{ Nm}$.

Etape 9: Remonter la selle du pilote en procédant dans l'ordre inverse par rapport aux opérations décrites à l'étape 2.

DE Phase 1: Führen Sie die Batterieaufladung, nach Instruktionen aus, die in seinem Paket eingeschlossen sind.

Phase 2: Den Motorradschlüssel in das hintere Schloss einstecken. Den Schlüssel in Uhrzeigersinn drehen und gleichzeitig den Fahrersitz aufheben, wie im bild beschrieben.

Phase 3: Die Batterie in den dazu geeigneten Raum anbringen.

Phase 4: Die Plusendverschlüss (+) auf den jeweiligen Pol der Batterie unter Berücksichtigung der auf der Abbildung angegebenen Anordnung montieren.

Phase 5: Die Schraube der Plusendverschlüss drehen und mit einem Drehmoment von $7 \div 8 \text{ Nm}$ festziehen.

Phase 6: Nach der Montage den **Schutzkasten** auf dem Pluspol anlegen (siehe Abbildung).

Phase 7: Die zwei Minusendverschlüss (-) auf den jeweiligen Pol der Batterie bei Berücksichtigung der auf der Abbildung angezeigten Anordnung montieren.

Phase 8: Die Schraube der Minusendverschlüss drehen und mit einem Drehmoment von $7 \div 8 \text{ Nm}$ festziehen.

Phase 9: Beim Wiedereinbau des Fahrersitz die unter Phase 2 angegebenen Vorgänge in umgekehrter Reihenfolge durchführen.

ES Fase 1: Realice la carga inicial de la batería según las instrucciones incluidas en su paquete.

Fase 2: Introducir la llave de la motocicleta en la cerradura posterior. Girar la llave en sentido de las agujas del reloj y al mismo tiempo levantar el sillín piloto, como se muestra en la foto.

Fase 3: Colocar la batería en su alojamiento.

Fase 4: Montar el terminal positivo (+) en el correspondiente polo de la batería respetando la posición indicada en la figura.

Fase 5: Girar el tornillo del terminal positivo y efectuar el apriete a un par igual a $7 \div 8 \text{ Nm}$.

Fase 6: Después del montaje colocar la **protección** en el polo positivo (ver figura).

Fase 7: Montar los 2 terminales negativos (-) en el correspondiente polo de la batería respetando la disposición mostrada en la figura.

Fase 8: Girar el tornillo de los terminales negativos y efectuar el apriete a un par igual a $7 \div 8 \text{ Nm}$.

Fase 9: Montar nuevamente el sillín piloto siguiendo el sentido contrario a las operaciones descritas en la fase 2.

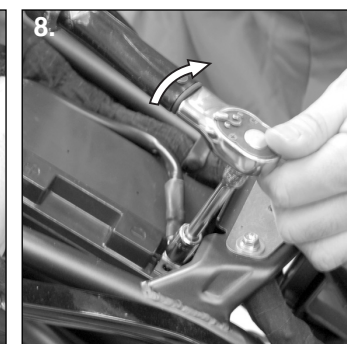
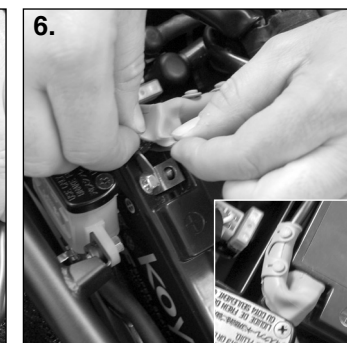
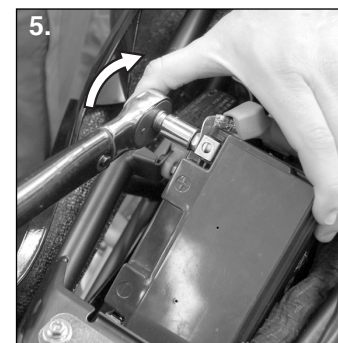
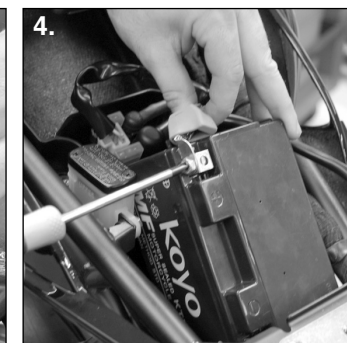
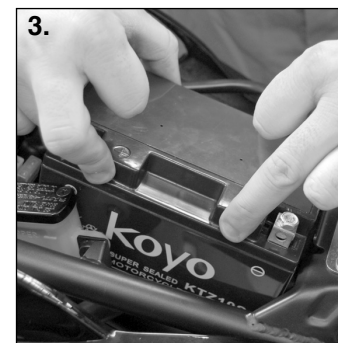
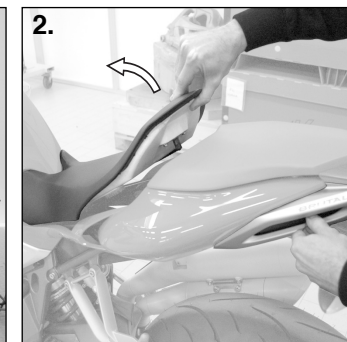
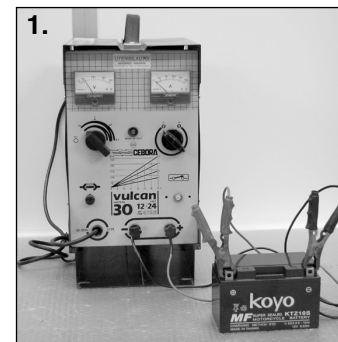

CAVO POSITIVO (+)
POSITIVE CABLE (+)
CABLE POSITIF (+)
PLUSKABEL (+)
CABLE POSITIVO (+)

CAVO NEGATIVO (-)
NEGATIVE CABLE (-)
CABLE NEGATIF (-)
MINUSKABEL (-)
CABLE NEGATIVO (-)

CAVO NEGATIVO (-)
NEGATIVE CABLE (-)
CABLE NEGATIF (-)
MINUSKABEL (-)
CABLE NEGATIVO (-)

CAPPUCCIO DI PROTEZIONE
PROTECTIVE CAP
CAPUCHON DE PROTECTION
SCHUTZKASTEN
CAPUCHON DE PROTECCION

POLO POSITIVO (+)
POSITIVE POLE (+)
POLE POSITIF (+)
PLUSPOL (+)
POLO POSITIVO (+)



POLO NEGATIVO (-)
NEGATIVE POLE (-)
POLE NEGATIF (-)
MINUSPOL (-)
POLO NEGATIVO (-)

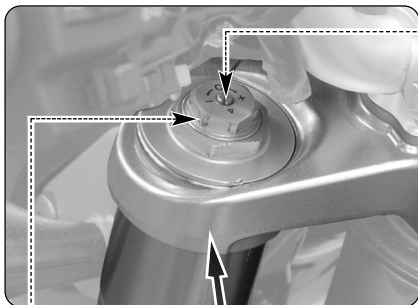

- Dispositivo idraulico di frenatura in compressione
- Compression damping hydraulic device
- Dispositif hydraulique de freinage en compression
- Hydraulische Kompressionsbremse
- Dispositivo hidráulico de frenado en compresión

- Prearico molla
- Spring preload
- Précharge du ressort
- Federvorspannung
- Precarga muelle

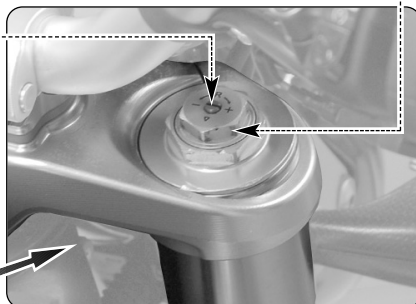

- Dispositivo idraulico di frenatura in estensione
- Rebound damping hydraulic device
- Dispositif hydraulique de freinage en détente
- Hydraulische Ausdehnungsbremse
- Dispositivo hidráulico de frenado en extensión

- Prearico molla
- Spring preload
- Précharge du ressort
- Federvorspannung
- Precarga muelle



- Dispositivo idraulico di frenatura in estensione
- Rebound damping hydraulic device
- Dispositif hydraulique de freinage en détente
- Hydraulische Ausdehnungsbremse
- Dispositivo hidráulico de frenado en extensión

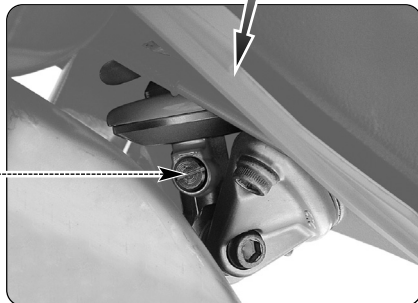

BRUTALE 990 R		Brutale 990 R	
		Tipo di assetto - Type of geometry - Type d'assiette - Einstellungsart - Tipo de equilibrado	
Sospensione anteriore <i>Front suspension</i> <i>Suspension avant</i> <i>Vordere Federung</i> <i>Suspensión delantera</i>		Su strada - On road - Sur route - Auf Straße - En la carretera	In pista - On race circuit - En circuit de course - Auf Rennstrecken - En circuito
Prearico molla <i>Spring preload</i> <i>Précharge du ressort</i> <i>Federvorspannung</i> <i>Precarga muelle</i>		1 giro turn tour Umdrehung revolucion	3 giri turns tours Umdrehungen revoluciones
Freno in estensione <i>Rebound damping</i> <i>Frein en détente</i> <i>Ausdehnungsbremse</i> <i>Freno en extensión</i>		2 giri turns tours Umdrehungen revoluciones	1,5 giri turns tours Umdrehungen revoluciones
Freno in compressione <i>Compression damping</i> <i>Frein en compression</i> <i>Kompressionsbremse</i> <i>Freno en compresión</i>		3 giri turns tours Umdrehungen revoluciones	2 giri turns tours Umdrehungen revoluciones
Sospensione posteriore <i>Rear suspension</i> <i>Suspension arrière</i> <i>Hintere Federung</i> <i>Suspensión trasera</i>		Su strada - On road - Sur route - Auf Straße - En la carretera	In pista - On race circuit - En circuit de course - Auf Rennstrecken - En circuito
Solo pilota * - Rider only - Uniquement pilote - Nur Fahrer - Solo piloto	Frenatura in estensione <i>Rebound damping</i> <i>Freinage en détente</i> <i>Ausdehnungsbremse</i> <i>Frenado en extensión</i>	16 scatti clicks emboîtements Rasten disparos	10 scatti clicks emboîtements Rasten disparos
Con passeggero * - With passenger * - Avec passager * - Mit Beifahrer * - Con pasajero *	Frenatura in estensione <i>Rebound damping</i> <i>Freinage en détente</i> <i>Ausdehnungsbremse</i> <i>Frenado en extensión</i>	16 scatti clicks emboîtements Rasten disparos	-

(*) Per l'utilizzo del veicolo con passeggero, MV Agusta consiglia di aumentare la pressione di gonfiaggio dei pneumatici anteriori e posteriori a **2.5 bar**. / When riding with a passenger, MV Agusta recommends to increase the front and rear tires pressure to **2.5 bars**. / Pour utiliser le véhicule avec le passager, MV Agusta recommande à augmenter la pression de gonflage du pneu avant et arrière à **2.5 bars**. / Für das Verwenden des Trägers mit dem Beifahrer, empfiehlt MV Agusta, die Vorder- und Hinterreifen Druck auf **2,5 bar** zu erhöhen. / Para usar el vehículo con el pasajero, MV Agusta recomienda de aumentar la presión de los neumáticos delanteros y traseros a **2.5 bar**.



MV Agusta Motor S.p.A. - Via G. Macchi, 144
21100 - Schiranna (VA) - ITALY
www.mvagusta.it
Part. N. 8000B3247 Ed. n° 2

MV-AG

BRUT
999

