



Motorcycle Art



MV AGUSTA F4 1000 R-R 1+1 312 / 1078 RR-RR 1+1 312

Manuale dell'utente - User's manual

A large, stylized white gear graphic on the left side of the page. Inside the gear, the 'MV Agusta' logo is written vertically in red and white.

MV
AGUSTA

MV AGUSTA



Manuale dell'utente
Versione Italiana

BIERA
100

Gentile cliente,

La ringraziamo per la fiducia accordataci e ci congratuliamo con Lei per la Sua nuova F4 312.

La Sua scelta premia l'impegno e lo sforzo fatto con passione dai nostri tecnici, per dare alla F4 312 caratteristiche funzionali ed estetiche che la pongono al di sopra delle moto di più alto livello oggi disponibili sul mercato, rendendola così un oggetto ambito ed esclusivo.

Se dal lato puramente tecnico la F4 312 rappresenta, con le sue innumerevoli innovazioni, un punto di riferimento a livello mondiale, la sua linea senza tempo, morbida ed affusolata, è una splendida fusione fra un glorioso passato e un nuovo millennio.

Il connubio di questi elementi, che solo la ricerca del dettaglio, la passione ed il desiderio di realizzare una moto tecnicamente ed esteticamente superiore hanno consentito di raggiungere, eleva la F4 312 al di sopra di qualsiasi moda passeggera, dandole così il privilegio di essere considerata un oggetto unico al mondo.

Se desiderasse ulteriori informazioni, non esiti a contattare il Servizio Assistenza Clienti MV Agusta.

Buon divertimento!

*Claudio Castiglioni
Presidente
MV Agusta*



INDICE GENERALE

<i>cap.</i>	<i>Descrizione argomenti</i>	<i>pag.</i>
1	INFORMAZIONI GENERALI	5
1.1.	Scopo del manuale	5
1.2.	Simbologia	6
1.3.	Contenuto del CD-Rom	7
1.4.	Dati di identificazione	8
2	INFORMAZIONI SULLA SICUREZZA	10
2.1.	Uso consentito del veicolo	10
2.2.	Manutenzione	10
2.3.	Accessori e modifiche	11
2.4.	Carico veicolo	11
3	COMANDI E STRUMENTI	13
3.1.	Posizione comandi e strumenti	13
3.2.	Cavalletto laterale	14
3.3.	Comandi semimanubrio sinistro	15
3.4.	Comandi semimanubrio destro	17
3.5.	Interruttore accensione e bloccasterzo	20
3.6.	Comando cambio	22
3.7.	Strumentazione e spie	23
3.7.1.	Spie luminose di indicazione	24
3.7.2.	Display multifunzione	25
3.8.	Tabella lubrificanti e liquidi	26

<i>cap.</i>	<i>Descrizione argomenti</i>	<i>pag.</i>
4	USO	27
4.1.	Uso della motocicletta	27
4.2.	Rodaggio	28
4.3.	Avviamento motore	30
4.4.	Selezione e modifica funzioni display	32
4.4.1.	Selezione funzioni display	33
4.4.2.	Regolazione delle unità di misura	35
4.4.3.	Azzeramento delle funzioni contachilometri parziali	38
4.4.4.	Regolazione della funzione orologio	41
4.4.5.	Cronometro	43
4.5.	Rifornimento carburante	52
4.6.	Accesso al vano portaoggetti	53
4.7.	Sosta della motocicletta	54
5	REGOLAZIONI	56
5.1.	Elenco regolazioni	56
5.2.	Tabella delle regolazioni	58
5.3.	Regolazione leva freno anteriore	59
5.4.	Regolazione leva frizione	59
5.5.	Regolazione specchietti retrovisori	60
5.6.	Regolazione ammortizzatore di sterzo	60



<i>cap.</i>	<i>Descrizione argomenti</i>	<i>pag.</i>
5.7.	Regolazione sospensione anteriore	61
5.7.1.	Prearico molla (sospensione anteriore)	62
5.7.2.	Dispositivo idraulico di frenatura in estensione (sospensione anteriore)	62
5.7.3.	Dispositivo idraulico di frenatura in compressione (sospensione anteriore)	63
5.8.	Regolazione sospensione posteriore	64
5.8.1.	Prearico molla (sospensione posteriore)	65
5.8.2.	Dispositivo idraulico di frenatura in estensione (sospensione posteriore)	66
5.8.3.	Dispositivo idraulico di frenatura in compressione per alte velocità (sospensione posteriore)	66
5.8.4.	Dispositivo idraulico di frenatura in compressione per basse velocità (sospensione posteriore)	66
5.9.	Regolazione proiettore anteriore	67



1.1. Scopo del manuale

Il presente Manuale fornisce le informazioni necessarie per un uso corretto e sicuro della moto.

Assieme al Manuale viene fornito un Quick Manual tascabile nel quale sono riportate le informazioni minime essenziali per l'uso del veicolo.

Il Manuale viene fornito anche in formato elettronico (.pdf) sul presente CD-Rom e può essere stampato o visualizzato su un qualsiasi PC, sia dotato di sistema Windows che Mac.

Vi raccomandiamo di leggere attentamente il Manuale prima di utilizzare la moto e di sincerarvi che chiunque utilizzi la moto abbia prima fatto lo stesso.

Vi raccomandiamo, infine, di portare sempre con Voi il Quick Manual completandolo con i dati identificativi vostri e della motocicletta.



Copyright
MV AGUSTA Motor Spa
Tutti i diritti riservati



1.2. Simbologia

Le parti di testo di particolare importanza, relative alla sicurezza della persona e all'integrità della motocicletta, sono evidenziate con i seguenti simboli:



Pericolo - Attenzione: la mancata o incompleta osservanza di queste prescrizioni può comportare pericolo grave per la propria incolumità e per quella di altre persone.



Cautela - Precauzione: la mancata o incompleta osservanza di queste prescrizioni può comportare un rischio di danni alla motocicletta.

Per indicare le persone autorizzate allo svolgimento delle operazioni di regolazione e/o manutenzione, esse sono contraddistinte dai seguenti simboli:



Informazioni sulle operazioni consentite al motociclista.



Informazioni sulle operazioni che devono essere svolte solo dal personale autorizzato.

Per evidenziare ulteriori informazioni vengono utilizzati i seguenti simboli:



Il simbolo  indica la necessità di utilizzare un attrezzo od un'attrezzatura specifica per il corretto svolgimento dell'operazione descritta.



Il simbolo “ § ” indica il rimando al capitolo identificato dal numero che lo segue.



1.3. Contenuto del CD-Rom

Nel CD-Rom fornito in dotazione troverete, oltre a questo Manuale, il Manuale di Manutenzione, il Quick Manual (di cui viene fornita anche la versione stampata), la Guida delle Concessionarie ed il Libretto di Garanzia.

Al momento della consegna della moto, il Vs. Concessionario vi ha consegnato il Certificato di Garanzia e Pre-Consegna.

Vi preghiamo di conservarlo unitamente ai documenti della moto ed ai futuri tagliandi di manutenzione che vi verranno via via consegnati in occasione degli interventi previsti.

IMPORTANTE

La copia del Certificato di Garanzia e Pre-Consegna destinata alla MV Agusta deve essere compilata dal Concessionario e resa alla fabbrica entro 10 gg. dalla data di immatricolazione.

Le copie dei tagliandi di manutenzione raccomandata devono essere sempre compilati dal Concessionario e resi alla MV Agusta entro 10 gg. dalla data di esecuzione degli interventi.



=1

2) numero di matricola motore

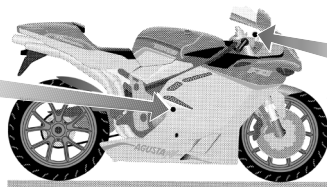
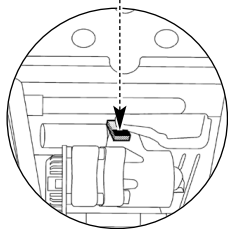

1) numero di matricola telaio

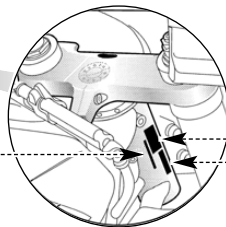

3) dati di omologazione

1.4. Dati di identificazione

- 1) numero di matricola telaio
- 2) numero di matricola motore
- 3) dati di omologazione

► Identificazione motocicletta

La motocicletta è identificata dal numero di matricola del telaio. Per ordinare le parti di ricambio, oltre a questo numero, può essere necessario indicare il numero di matricola motore, il codice colore e il numero di identificazione chiave.

Si consiglia di annotare i dati principali negli spazi sotto riportati.

TELAIO N.: _____

MOTORE N.: _____



► Identificazione chiave della motocicletta

Viene fornita, in duplice copia, una chiave da utilizzare sia per l'avviamento che per l'azionamento di tutte le serrature. Custodire in luogo sicuro la copia di scorta.

La conoscenza del numero di identificazione chiave è essenziale nel caso in cui si renda necessario richiedere un duplicato della chiave a ricambio. Si consiglia di annotare tale numero nel seguente spazio:

CHIAVE N.: _____

► Identificazione combinazione colori motocicletta

Il codice colore è indispensabile per ordinare le parti di ricambio della carrozzeria. Tale codice può essere letto sulla targhetta situata nella parte interna del codone.

Si consiglia di annotare il codice colore della motocicletta nel seguente spazio:

CODICE COLORE : _____

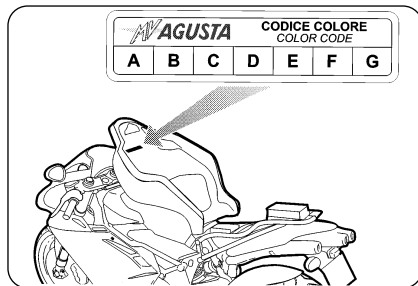
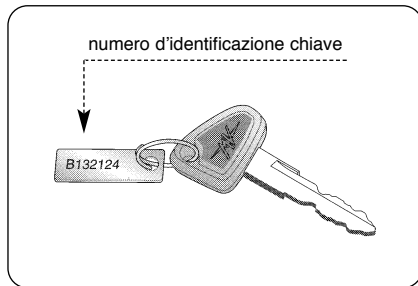



2.1. USO CONSENTITO DEL VEICOLO

La Vostra motocicletta e' stata progettata per un utilizzo esclusivamente stradale ed autostradale.



ATTENZIONE

Saltuariamente e' possibile utilizzare la moto in pista in occasioni non competitive.

In tale caso, tuttavia, a causa delle maggiori sollecitazioni a cui in tale specifico utilizzo la moto e' sottoposta, si raccomanda di far verificare da un Centro Assistenza MV Agusta le condizioni della moto prima e dopo l'uso.

Ogni altro utilizzo e' proibito ed espressamente escluso.

Potete trovare ulteriori informazioni circa l'uso della moto nella sezione 4 del presente Manuale.

2.2. MANUTENZIONE

Per garantire la massima efficienza ed affidabilità del veicolo è essenziale eseguire gli interventi manutentivi previsti nel Manuale di Manutenzione.

MV Agusta raccomanda che tutti gli interventi di manutenzione siano effettuati solo da personale specializzato appartenente ad un Centro Assistenza MV Agusta.

Laddove, viceversa, decidiate di far eseguire gli interventi di manutenzione da officine terze, dovette farVi confermare che le stesse abbiano la capacità e gli strumenti specifici necessari all'esecuzione di tali interventi.



ATTENZIONE

La garanzia MV Agusta potrebbe non operare laddove officine terze abbiano effettuato interventi sulla moto in modo difforme da quanto previsto dalle Circolari Tecniche e nei relativi Manuali di Officina MV Agusta.



2.3. ACCESSORI E MODIFICHE



ATTENZIONE

MV Agusta vieta di apportare qualsiasi modifica alle proprie motociclette.

Questo è necessario al fine di salvaguardare la sicurezza dei suoi Clienti.

È tuttavia possibile personalizzare la Vostra motocicletta attingendo dal ricco catalogo accessori MV Agusta.



ATTENZIONE

L'installazione di alcuni di questi accessori può invalidare l'omologazione della moto e, pertanto, comportare la sua non ulteriore utilizzabilità su strada pubblica.

In caso di dubbio Vi consigliamo di consultarVi con il vostro Concessionario MV Agusta di fiducia per decidere quali accessori siano più adatti alle Vostre esigenze.

2.4. CARICO VEICOLO

Il veicolo nelle versioni **F4 1078 RR 312** e **F4 1000 R 312** è progettato per l'impiego da parte del solo pilota, mentre le versioni **F4 1078 RR 1+1 312** e **F4 1000 R 1+1 312** ne estendono l'impiego anche al trasporto di un passeggero. Per un utilizzo in piena sicurezza e nel rispetto delle norme del codice stradale è obbligatorio non superare mai la massa massima tecnicamente ammissibile dei veicoli, i cui valori sono qui di seguito riportati:

F4 1078 RR 312 / F4 1000 R 312

Peso massimo totale **340 kg**

Peso massimo trasportabile **110 kg**

F4 1078 RR 1+1 312 / F4 1000 R 1+1 312

Peso massimo totale **420 kg**

Peso massimo trasportabile **180 kg**



Il peso massimo totale rappresenta la somma dei seguenti pesi, secondo la direttiva CEE 92/61:

- peso del motociclo;
- peso del pilota;
- peso del passeggero (solo per F4 1078 RR 1+1 312 e F4 1000 R 1+1 312);
- peso del carico e degli accessori.

**ATTENZIONE**

Dato che il carico ha un impatto enorme sulla manovrabilità, la frenata, le prestazioni e le caratteristiche di sicurezza del vostro mezzo, tenere sempre presenti le seguenti precauzioni.

- **NON SOVRACCARICARE MAI IL MOTOCICLO!** L'uso di un motociclo sovraccaricato può provocare danneggiamenti dei pneumatici, perdite del controllo o infortuni gravi. Verificare che il peso totale del pilota, del passeggero, del carico e degli accessori non superi il carico massimo specificato per il motociclo.



3.1. Posizione comandi e strumenti

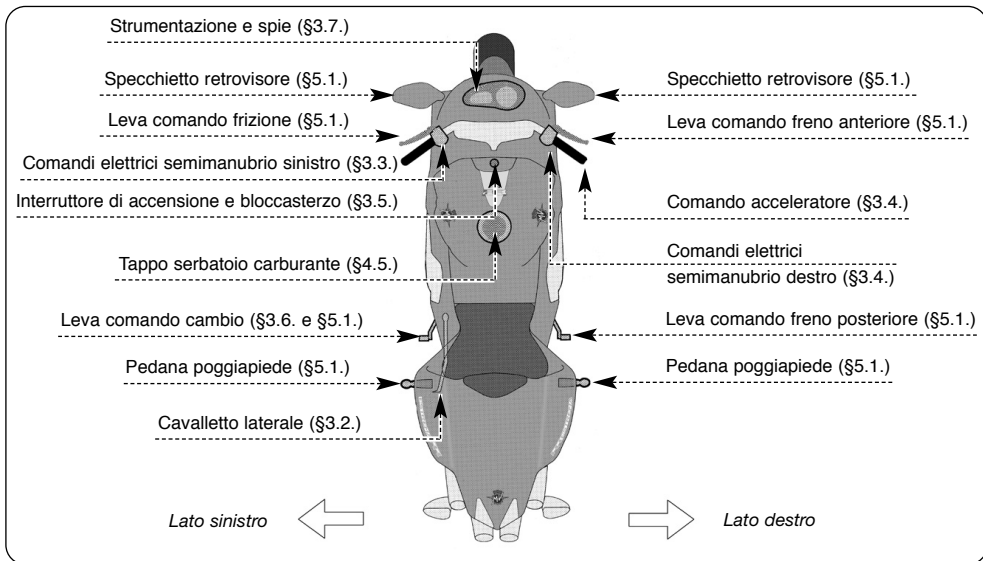



3.2. Cavalletto laterale

Il cavalletto laterale è dotato di un interruttore di sicurezza che impedisce al motociclo di mettersi in marcia con il cavalletto abbassato. Nel caso in cui, a motore avviato e nella condizione di cavalletto abbassato, si azioni il cambio per porsi in movimento, l'interruttore interrompe la corrente al motore provocandone lo spegnimento. Nel caso in cui la moto si trovi invece nella condizione di stazionamento (cavalletto abbassato) e con un rapporto del cambio inserito, l'interruttore impedisce l'avviamento del motore evitando ogni rischio di caduta accidentale del veicolo.

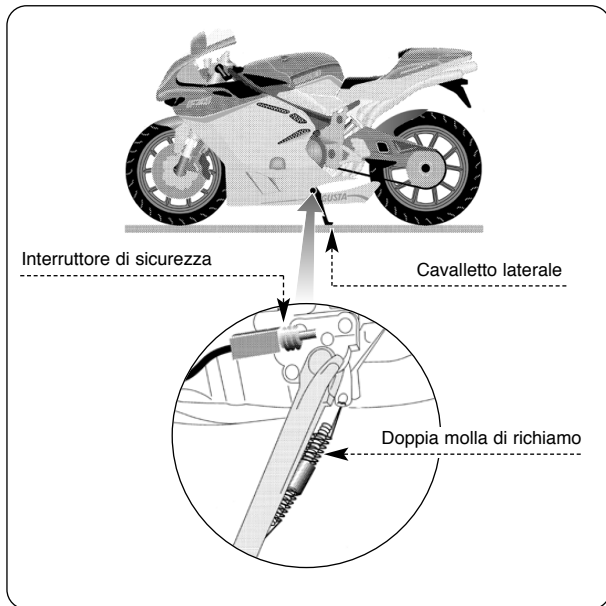

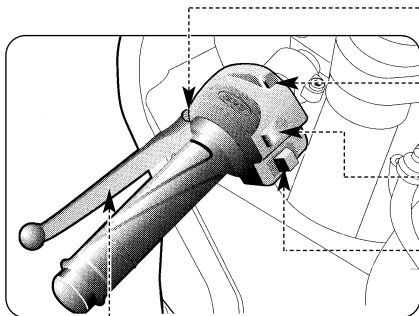

3.3. Comandi semimanubrio sinistro

**Pulsante lampeggio fari**

Premere il pulsante a ripetizione.

Pulsante abbagliante/anabbagliante

Pulsante in fuori ■ : anabbagliante 

Pulsante in dentro ▬ : abbagliante 

Pulsante avvisatore acustico

Premere per attivare l'avvisatore acustico.

Leva indicatori di direzione

Spostando la leva a destra o a sinistra si attivano gli indicatori di direzione destri o sinistri. La leva torna al centro; premere per disattivare gli indicatori.

Leva frizione

Accostare o allontanare dalla manopola per comandare la frizione.



Pulsante Lampeggio Faro

Questa funzione serve a richiamare l'attenzione degli altri utenti della strada in caso di possibili situazioni di pericolo; con l'abbagliante acceso tale funzione non è attiva.

Pulsante Abbagliante/Anabbagliante

Normalmente viene attivata la funzione anabbagliante; quando le condizioni di traffico e di percorso lo consentono, può essere attivata la funzione abbagliante agendo sul pulsante.

Pulsante Avvisatore Acustico

Questa funzione serve a richiamare l'attenzione degli altri utenti della strada in caso di possibili situazioni di pericolo.

Leva Indicatori di Direzione

Questa funzione permette di segnalare agli altri utenti della strada l'intenzione di cambiare direzione o corsia di marcia.



ATTENZIONE

Il mancato uso o la mancata disattivazione degli indicatori di direzione al momento opportuno può essere causa di incidenti; gli altri utenti della strada potrebbero infatti trarre conclusioni sbagliate riguardo all'effettivo tragitto del veicolo. Azionare sempre gli indicatori di direzione prima di svoltare o cambiare corsia.

Accertarsi poi di disattivare gli indicatori non appena effettuata la suddetta manovra.

Leva Frizione

Questa leva, attraverso un dispositivo a controllo idraulico, consente l'innesto ed il disinnesto della frizione.

**3.4. Comandi semimanubrio destro****Interruttore stop motore**

Se azionato arresta il motore e ne impedisce l'avviamento.

Pulsante avviamento motore

Premuto avvia il motore. Va rilasciato appena avviato. Con motore avviato, ripremendo, si selezionano le funzioni del display.

Leva avviamento a freddo del motore (Choke)

Ruotare in senso orario per l'avviamento a freddo del motore. Dopo alcuni secondi riportare la leva nella sua posizione iniziale.

Comando acceleratore

Ruotare per regolare l'alimentazione del motore.

Leva freno anteriore

Avvicinare alla manopola per azionare il freno anteriore.

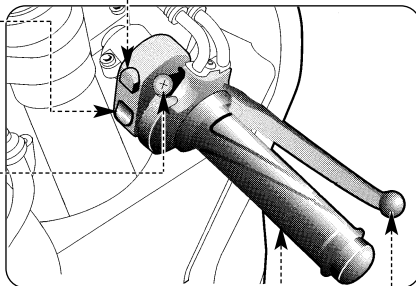

**Interruttore Stop Motore**

Questa funzione permette di arrestare il motore in caso di emergenza; in questo modo viene disattivato il circuito di accensione impedendo il riavvio del motore. Per poter effettuare l'avviamento riportare il pulsante in posizione di riposo.

NOTA

In condizioni normali non utilizzare questo dispositivo per l'arresto del motore.

Pulsante Avviamento Motore

Questo dispositivo consente l'avviamento del motore; inoltre a motore avviato esso permette di selezionare le funzioni del display presente nella strumentazione di bordo.

**CAUTELA**

Per evitare danni all'impianto elettrico non tenere premuto il pulsante per un tempo superiore ai 5 secondi consecutivi.

Se il motore non si avvia dopo alcuni tentativi, consultare il capitolo "GUASTI" nel presente manuale.

Leva Avviamento a freddo del Motore (Choke)

Il dispositivo facilita l'avviamento a freddo agendo sull'alimentazione.

NOTA

Questa funzione deve essere mantenuta attiva per un tempo limitato ed in ogni caso dipendente dalla temperatura del motore e dell'ambiente esterno. Quando il regime minimo di rotazione è sufficiente a mantenere avviato il motore, è opportuno disattivare il comando.

**Comando Acceleratore**

Questo dispositivo consente di regolare l'alimentazione del motore variandone così il regime di rotazione. Per azionare il dispositivo occorre ruotare la manopola dalla posizione di riposo, corrispondente alla condizione di regime minimo del motore.

Nella condizione di avviamento a freddo (Choke attivo), la ripetuta rotazione della manopola nel senso di chiusura del gas permette di riportare la leva di choke in posizione di riposo.

Leva Freno Anteriore

Questo comando permette di azionare attraverso un circuito idraulico l'impianto frenante della ruota anteriore.



3.5. Interruttore accensione e bloccasterzo



ATTENZIONE

Non applicare portachiavi o altri oggetti alla chiave di accensione per non creare ostacoli alla rotazione dello sterzo.



ATTENZIONE

Non tentare di cambiare alcuna funzione dell'interruttore durante la marcia; si potrebbe incorrere nella perdita di controllo del mezzo.

L'interruttore di accensione attiva e disattiva il circuito elettrico ed il bloccasterzo; le quattro posizioni di comando sono di seguito descritte.

Posizione "OFF"

Tutti i circuiti elettrici sono disattivati. La chiave può essere estratta.

Posizione "ON"

Tutti i circuiti elettrici sono attivati, la strumentazione e le spie eseguono l'autodiagnosi; il motore può essere avviato. La chiave non può essere estratta.

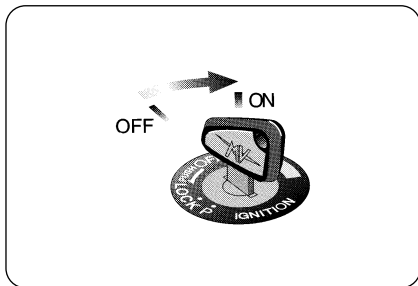

CAUTELA

Non lasciare la chiave sulla posizione "ON" a motore spento per lungo tempo, allo scopo di evitare il danneggiamento dei componenti elettrici della motocicletta.



Posizione "LOCK"

Ruotare il manubrio a destra o a sinistra. Premere leggermente la chiave e contemporaneamente ruotarla in posizione "LOCK".

Tutti i circuiti elettrici sono disattivati e lo sterzo è bloccato. La chiave può essere estratta.

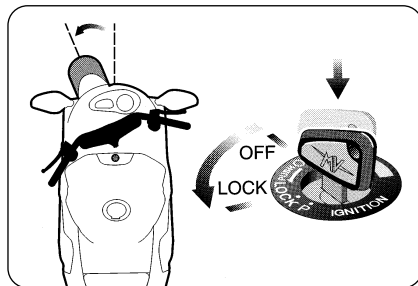

3

Posizione "P"

Ruotare la chiave dalla posizione "LOCK" alla posizione "P". Tutti i circuiti elettrici sono disattivati tranne le luci di parcheggio (luci di posizione) e lo sterzo è bloccato.

La chiave può essere estratta.



CAUTELA

Non lasciare la chiave sulla posizione "P" per lungo tempo, allo scopo di evitare di scaricare la batteria della motocicletta.

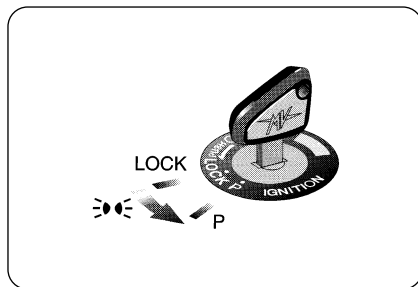



3.6. Comando cambio

La posizione **N** "Neutral" corrisponde alla posizione di folle segnalata dalla relativa spia cruscotto.

Spostando la leva del cambio verso il basso si innesta la prima marcia.

Analogamente, spostando la leva verso l'alto si innesta la seconda marcia; continuando più volte a spostare la leva verso l'alto si innestano, in modo sequenziale, tutte le altre marce fino alla sesta.

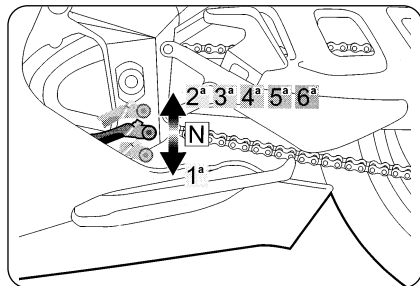



3.7. Strumentazione e spie

Gli strumenti e le spie si attivano ruotando la chiave di accensione in posizione "ON". Dopo un check-up iniziale (~ 7 secondi) le informazioni corrispondono alle condizioni generali della motocicletta in quel momento.

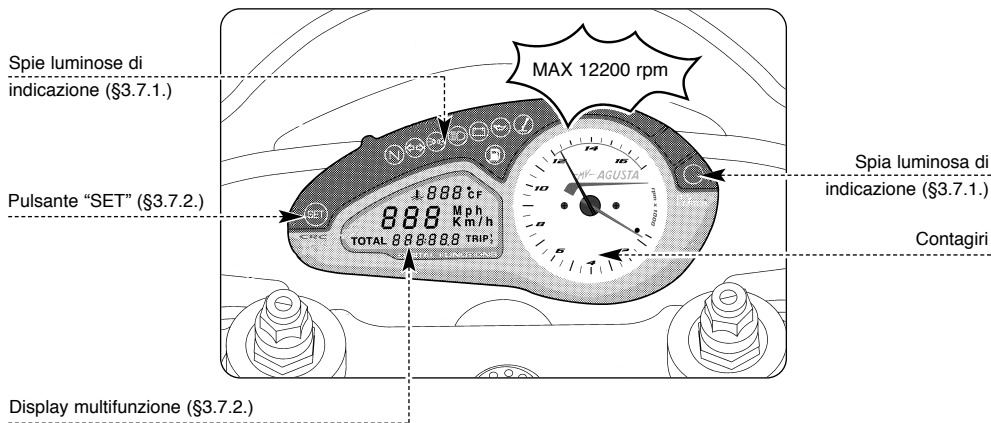



3.7.1. Spie luminose di indicazione

Spia luce abbagliante (blu)

Si accende quando è attivata la luce abbagliante.

Spia luce anabbagliante (verde)

Si accende quando è attivata la luce anabbagliante.

Spia cambio in folle (verde)

Si accende quando il cambio è nella posizione folle "Neutral".

Spia indicatori di direzione (verde)

Si accende quando sono attivati gli indicatori di direzione.

Spia riserva carburante (arancio)

Si accende quando nel serbatoio sono contenuti circa 4 litri di carburante.

Spia carica batteria (rosso)

Si accende quando l'alternatore non fornisce la corrente elettrica sufficiente a caricare la batteria.

Se l'accensione avviene durante la marcia rivolgersi ad un centro assistenza autorizzato.

Spia apertura cavalletto laterale (rosso)

Si accende quando il cavalletto è abbassato.

Spia limitatore giri (rosso)

Si accende quando il motore supera i 12200 rpm; il limitatore interviene a 13000 rpm.

Spia pressione olio motore (rosso)

Si accende quando l'olio è ad una pressione insufficiente.



Pericolo - Attenzione: Se si accende durante la marcia, fermarsi immediatamente, controllare il livello dell'olio e se necessario farne effettuare il rabbocco presso un centro assistenza autorizzato MV Agusta (vedi §3.8). Se la spia si accende nonostante il livello sia corretto, non proseguire la marcia e contattare un centro assistenza autorizzato MV Agusta.

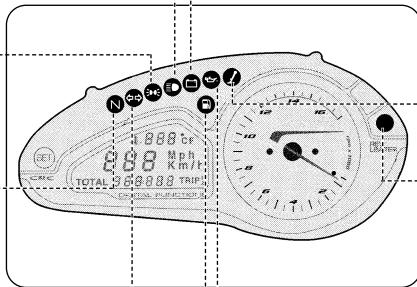



3.7.2. Display multifunzione

Tachimetro

Indica la velocità. Il valore può apparire in chilometri orari (Km/h) oppure in miglia orarie (Mph). Il valore a fondo scala è di 350 Km/h (218 Mph).

Pulsante "SET"

Se premuto, consente di selezionare le cifre del display per effettuare le regolazioni. Se premuto nuovamente consente di confermare le cifre impostate.

Se premuto insieme al pulsante di avviamento motore consente l'attivazione della funzione cronometro.

Contachilometri totale "TOTAL"

Indica la percorrenza totale; da 0 a 99999.9 (Km o mi)

Contachilometri parziale 1 "TRIP 1"

Indica la percorrenza parziale; da 0 a 9999.9 (Km o mi)

Contachilometri parziale 2 "TRIP 2"

Indica la percorrenza parziale; da 0 a 9999.9 (Km o mi)

Orologio

Indica l'ora (0÷24).

Termometro

Indica la temperatura del liquido di raffreddamento. Il valore può apparire in gradi centigradi (° C) oppure in gradi fahrenheit (° F).

Il campo di indicazione è compreso tra 40° e 140° C (104° e 284° F):

- sotto i 40° C (104° F) l'indicazione non appare ma appaiono tre linee lampeggianti; è il segnale di temperatura molto bassa;
- tra 40° e 49° C (104° e 120° F) l'indicazione lampeggia; è il segnale di temperatura bassa;
- tra i 50° e 111° C (122° e 232° F) l'indicazione è fissa;
- tra 112° e 140° C (234° e 284° F) l'indicazione lampeggia; è il segnale di temperatura alta.

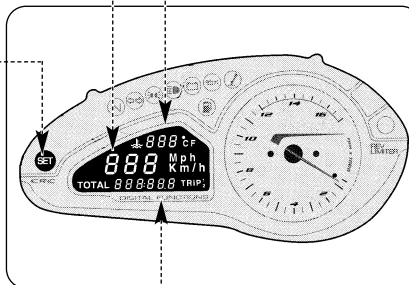

Pericolo - Attenzione: se la temperatura supera i 120° C (248° F) arrestare la motocicletta e controllare il livello del liquido di raffreddamento. Nel caso in cui fosse necessario rabboccarlo, rivolgersi presso un centro assistenza autorizzato MV Agusta (vedi § 3.8). Se la spia si accende nonostante il livello sia corretto, non proseguire la marcia e contattare un centro assistenza autorizzato MV Agusta.



3.8. Tabella lubrificanti e liquidi

Descrizione	Prodotto consigliato	Specifiche
Olio lubrificazione motore	AGIP RACING 4T 10W/60 (*)	SAE 10W/60 - API SJ
Liquido di raffreddamento	AGIP ECO - PERMANENT	Glicole - Etilenico diluito con 50% di acqua distillata
Fluido comando frizione e freni	AGIP BRAKE FLUID DOT4	DOT4
Olio lubrificazione catena	MOTUL CHAIN LUBE ROAD	-

* : Per la reperibilità del prodotto consigliato, MV Agusta consiglia di rivolgersi direttamente ai propri concessionari autorizzati. L'olio motore AGIP Racing 4T 10W/60 è stato realizzato appositamente per il motore del motociclo F4. Qualora il lubrificante descritto non fosse reperibile, MV Agusta consiglia l'utilizzo di olii completamente sintetici con caratteristiche conformi o superiori alle seguenti normative:

- Conforme API SJ
- Conforme ACEA A3
- Conforme JASO MA
- Gradazione SAE 20 W-50 o 10 W-60

NOTA

Le specifiche sopra indicate devono essere riportate, da sole od insieme ad altre, sul contenitore dell'olio lubrificante.





4.1. Uso della motocicletta

In questa sezione vengono esposti gli argomenti principali per il corretto uso della motocicletta.



ATTENZIONE

Il Vostro motociclo presenta elevate caratteristiche di potenza e prestazioni; per il suo uso è pertanto richiesto un'adeguato livello di conoscenza del mezzo. Al momento del primo utilizzo di questo veicolo è necessario adottare un atteggiamento prudente. Uno stile di guida aggressivo o avventato può esporre al rischio di incidenti, compromettendo la Vostra incolumità e quella di altre persone.



ATTENZIONE

LE LIMITAZIONI RELATIVE ALL'USO CONSENTITO DEL VEICOLO SONO RIPORTATE NELLA SEZIONE "INFORMAZIONI PER LA SICUREZZA".



CAUTELA

Le alte temperature derivanti dall'impiego del veicolo in pista potrebbero compromettere l'efficienza del convertitore catalitico e dell'impianto di scarico; pertanto durante l'uso in pista si consiglia di utilizzare un impianto di scarico speciale.



4.2. Rodaggio



Cautela - Precauzione: l'inosservanza delle indicazioni di seguito riportate può pregiudicare la durata e le prestazioni della motocicletta.

È uso comune considerare il rodaggio come una fase applicata al solo motore. In realtà esso va considerato anche per altre parti importanti della moto, in particolare i pneumatici, i freni, la catena di trasmissione, ecc. Nei primissimi chilometri adottare una guida tranquilla.

Da 0 a 500 Km (da 0 a 300 mi) (A)

Durante questa percorrenza variare frequentemente il regime di rotazione del motore. Se possibile, privilegiare percorsi leggermente collinosi, con molte curve ed evitare lunghi tratti rettilinei.

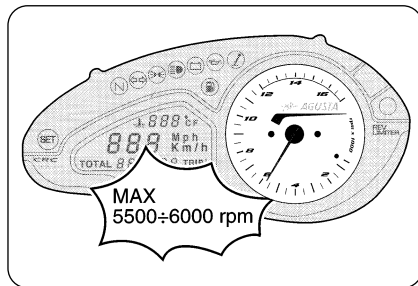

ATTENZIONE

I pneumatici nuovi devono essere sottoposti ad un adeguato rodaggio per raggiungere la completa efficienza. Evitare le accelerazioni, le curve e le frenate brusche per i primi 100 km. Se non si osserva un periodo di rodaggio iniziale dei pneumatici, si rischia di slittare o di perdere il controllo del veicolo con conseguente pericolo di incidenti.



❑ **Da 500 a 1000 Km (da 300 a 600 mi)**

Durante questa percorrenza evitare di mantenere a lungo il motore sotto sforzo.

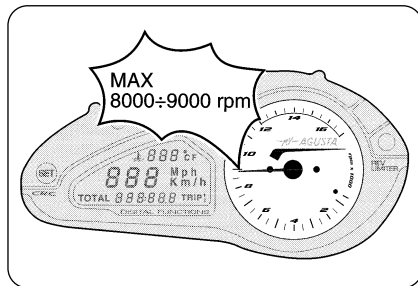

❑ **Da 1000 a 2500 Km (da 600 a 1600 mi)**

Durante questa percorrenza è possibile pretendere maggiori prestazioni dal motore, senza tuttavia superare il regime di rotazione indicato.

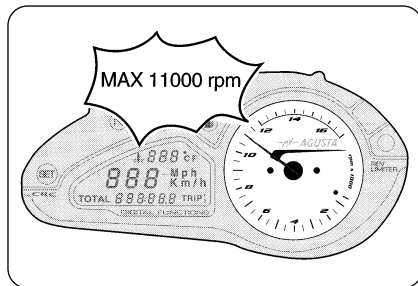



4.3. Avviamento motore



ATTENZIONE

Far funzionare il motore in un ambiente chiuso può essere pericoloso. I gas di scarico contengono monossido di carbonio, un gas incolore ed inodore che può provocare decessi o infortuni gravi. Fare funzionare il motore solo all'esterno, all'aria aperta.

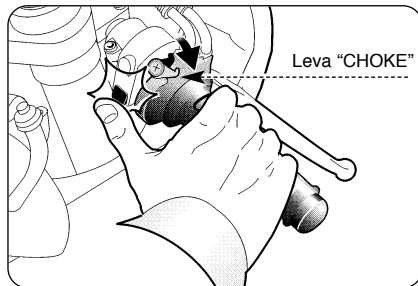

4

► Ruotando l'interruttore d'accensione in posizione "ON", la strumentazione e le spie eseguono l'autodiagnosi; durante questa fase, accertarsi dell'accensione di tutte le spie presenti sul cruscotto. Affinché il sistema di interruzione del circuito di accensione dia il consenso all'avviamento, deve essere stata soddisfatta una delle seguenti condizioni:

- Il cambio è in posizione di folle.
- Il cambio è innestato su una marcia con la leva della frizione tirata ed il cavalletto laterale alzato.

☐ Avviamento a freddo

► Ruotare la leva "CHOKE", senza ruotare la manopola dell'acceleratore e premere il pulsante.



► Appena il motore si è avviato, rilasciare il pulsante e dopo un breve riscaldamento riportare la leva nella sua posizione iniziale.

☐ **Avviamento a caldo**

- Premere il pulsante senza ruotare la manopola dell'acceleratore.
- Appena il motore si è avviato rilasciare il pulsante.



Cautela - Precauzione:

- Per evitare danni all'impianto elettrico non azionare l'avviamento per più di 5 secondi consecutivi.
- Non far funzionare a lungo il motore a motocicletta ferma. Il conseguente surriscaldamento può danneggiare i componenti interni del motore. È preferibile portare il motore alla temperatura di esercizio ponendosi in marcia ad andatura ridotta.
- Per allungare al massimo la vita del motore, non accelerare a fondo quando il motore è freddo.

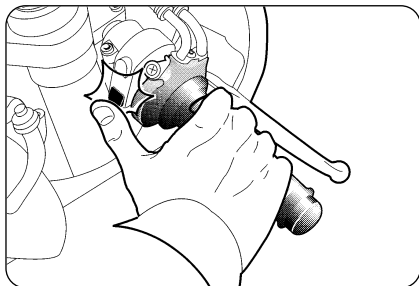



4.4. Selezione e modifica delle funzioni display

La strumentazione prevede la possibilità di intervenire su alcuni dei parametri principali di misurazione e di attivare la funzione cronometro.

Le operazioni possibili sono :

- Selezione delle funzioni:

Contachilometri	Totale	"TOTAL"
Contachilometri	Parziale 1	"TRIP 1"
Contachilometri	Parziale 2	"TRIP 2"
Orologio		
Cronometro		

- Regolazione delle unità di misura relative a:

- Velocità
- Distanza percorsa
- Temperatura

- Azzeramento delle funzioni contachilometri parziali:

Contachilometri	Parziale 1	"TRIP 1"
Contachilometri	Parziale 2	"TRIP 2"

- Regolazione della funzione orologio

- Attivazione della funzione cronometro

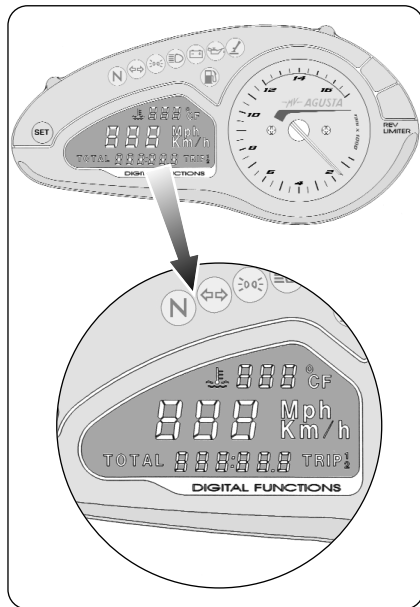



4.4.1. Selezione funzioni display

La selezione riguarda le funzioni:

- Contachilometri Totale "TOTAL"
- Contachilometri Parziale 1 "TRIP 1"
- Contachilometri Parziale 2 "TRIP 2"
- Orologio
- Cronometro

► La visualizzazione delle funzioni "TOTAL", "TRIP 1" e "TRIP 2", avviene premendo il pulsante di avviamento motore. Agendo su tale pulsante appaiono sul display le funzioni in modo ciclico. Selezionare la funzione desiderata.

► La visualizzazione della funzione cronometro è illustrata nella pagina seguente.

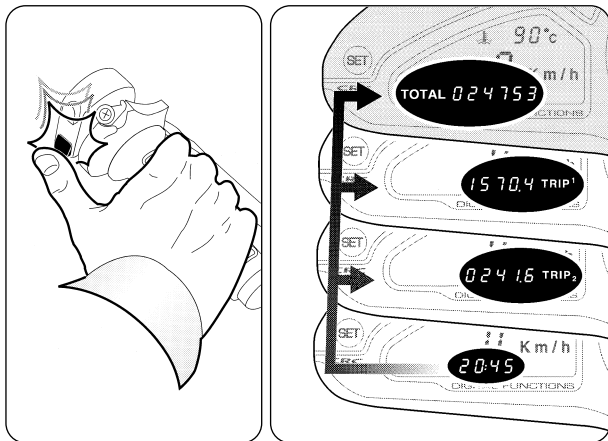

4



ATTENZIONE

Le operazioni di modifica o regolazione delle funzioni display devono essere eseguite con motore acceso, cambio in folle, motocicletta ferma e piedi a terra. È vietato cambiare le impostazioni del display durante la marcia.



□ Cronometro

► L'attivazione del cronometro è possibile solamente se sul display è visualizzata una delle seguenti funzioni:

- Contachilometri Totale "TOTAL"
- Contachilometri Parziale 1 "TRIP 1"
- Contachilometri Parziale 2 "TRIP 2"
- Orologio

► Premere contemporaneamente il pulsante "SET" ed il pulsante di avviamento motore per almeno 2 secondi.

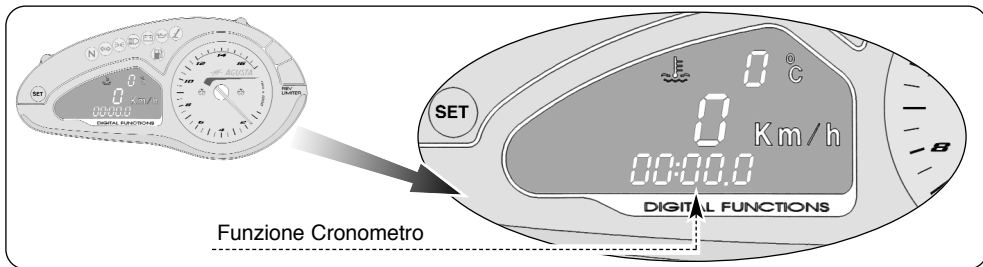
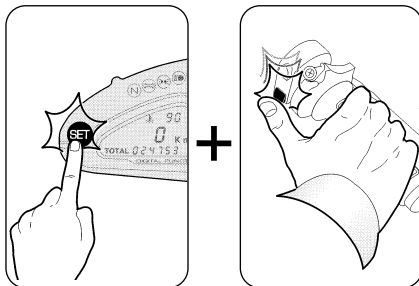

Il funzionamento del Cronometro è illustrato ai paragrafi successivi (§ 4.4.5).



4.4.2. Regolazione delle unità di misura

È possibile eseguire la modifica delle unità di misura.



ATTENZIONE

Le operazioni di modifica o regolazione delle funzioni display devono essere eseguite con motore acceso, cambio in folle, motocicletta ferma e piedi a terra. È vietato cambiare le impostazioni del display durante la marcia.

□ Tachimetro (Km/h - Mph)

- ▶ Premere ripetutamente il pulsante di avviamento motore fino alla visualizzazione della funzione contachilometri totale "TOTAL".
- ▶ Premere il pulsante "SET"; l'unità di misura del tachimetro inizia a lampeggiare.

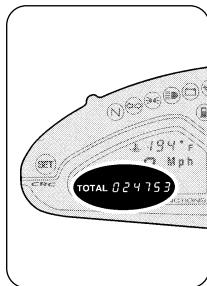
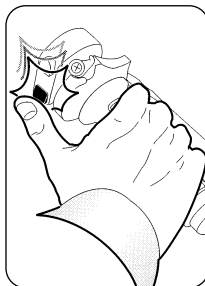

4

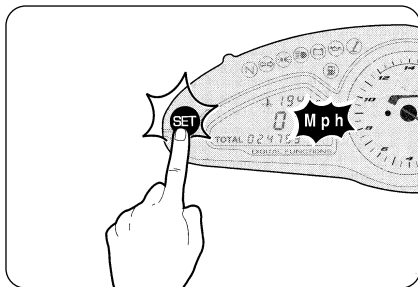



► Premere il pulsante di avviamento motore per passare da Km/h a Mph o viceversa. Variando l'unità di misura del tachimetro, varia automaticamente anche quella del contachilometri (totale e parziale).

Si ricorda che 1 mi = 1,609 Km

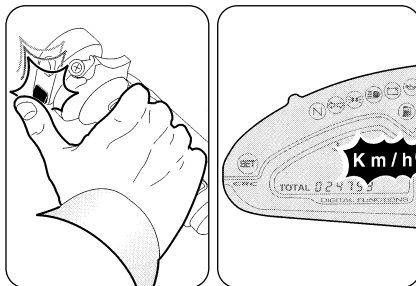

=4

► Premere il pulsante "SET"; l'unità di misura del tachimetro viene confermata e l'unità di misura del termometro inizia a lampeggiare. Si può procedere alla regolazione successiva.

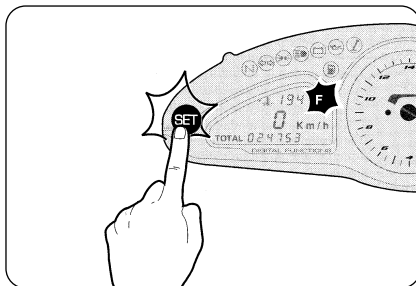



□ Termometro (° C - ° F)

► Premere il pulsante di avviamento motore per passare da ° C a ° F o viceversa.

Si ricorda che $T (^{\circ}\text{F}) = 1,8 \cdot t (^{\circ}\text{C}) + 32$

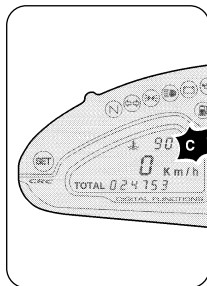
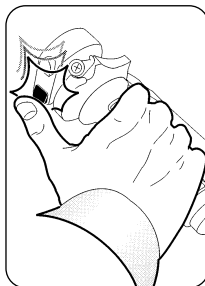

► Premere il pulsante "SET" per confermare l'unità di misura.

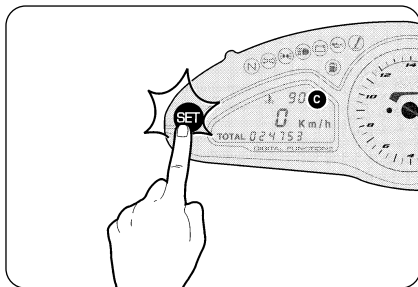



4.4.3. Azzeramento delle funzioni contachilometri parziali

I valori delle funzioni "TRIP 1" e "TRIP 2" possono essere azzerati nel modo seguente.



ATTENZIONE

Le operazioni di modifica o regolazione delle funzioni display devono essere eseguite con motore acceso, cambio in folle, motocicletta ferma e piedi a terra. È vietato cambiare le impostazioni del display durante la marcia.

► Premendo il pulsante di avviamento motore attivare la funzione "TRIP 1".

► Premere il pulsante di avviamento motore per un tempo superiore ai quattro secondi; il valore "TRIP 1" inizia a lampeggiare.

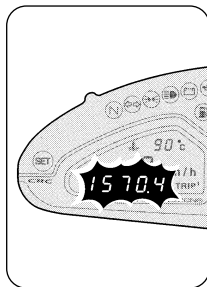
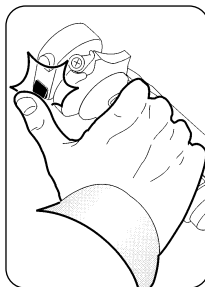
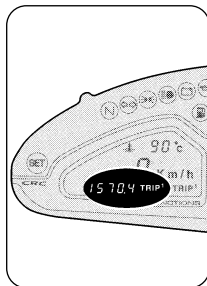
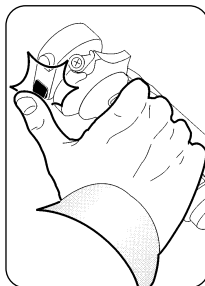



► Premendo ora il pulsante di avviamento motore per un tempo inferiore a quattro secondi il valore si azzerava. Se invece si preme il pulsante di avviamento motore per un tempo superiore ai quattro secondi la procedura di azzeramento viene interrotta.

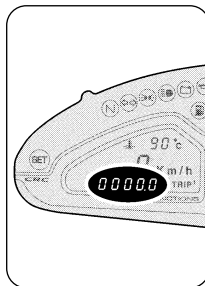
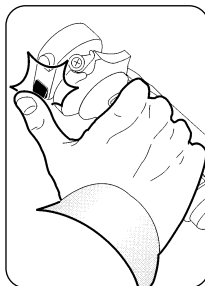

► Premendo il pulsante di avviamento motore attivare la funzione "TRIP 2".

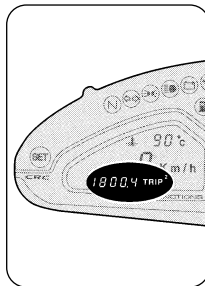
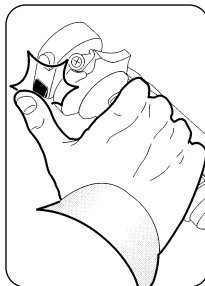

4



► Premere il pulsante di avviamento motore per un tempo superiore ai quattro secondi; il valore "TRIP 2" inizia a lampeggiare.

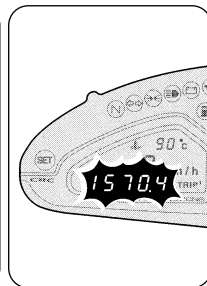
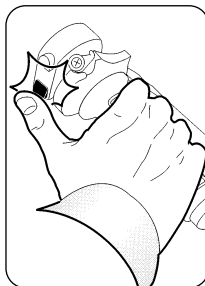

4

► Premendo ora il pulsante di avviamento motore per un tempo inferiore a quattro secondi il valore si azzerava. Se invece si preme il pulsante di avviamento motore per un tempo superiore ai quattro secondi la procedura di azzeramento viene interrotta.

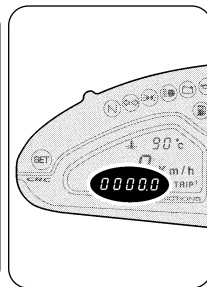
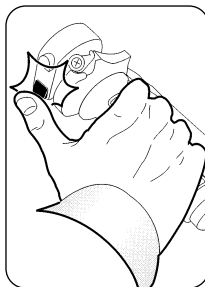



4.4.4. Regolazione della funzione orologio

E' possibile eseguire la regolazione della funzione orologio.



ATTENZIONE

Le operazioni di modifica o regolazione delle funzioni display devono essere eseguite con motore acceso, cambio in folle, motocicletta ferma e piedi a terra. È vietato cambiare le impostazioni del display durante la marcia.

- ▶ Premere ripetutamente il pulsante di avviamento motore fino alla visualizzazione della funzione orologio.
- ▶ Premere il pulsante "SET"; la prima cifra dell'ora inizierà a lampeggiare.

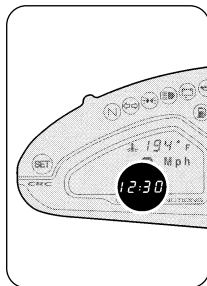
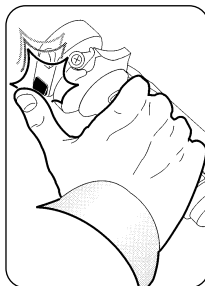

4

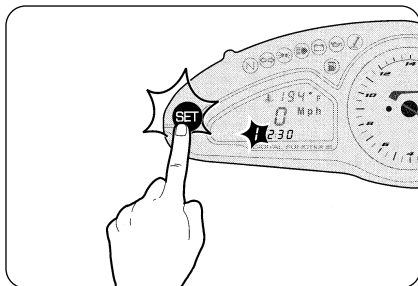



► Premere il pulsante di avviamento motore per la regolazione della cifra; rilasciare appena si raggiunge la cifra desiderata.

NOTA

Per ottenere lo scorrimento veloce della cifra selezionata tenere premuto il pulsante di avviamento motore per oltre due secondi.

► Premere il pulsante “SET” per la conferma e per procedere alla regolazione della cifra successiva.

► Ripetere la procedura per regolare la seconda cifra dell'ora, la prima e la seconda cifra dei minuti.

► Premere il pulsante “SET” per confermare la regolazione dell'ora e per interrompere la selezione (il lampeggio).

NOTA

La strumentazione dispone di una memoria integrale che conserva tutti i parametri anche a motore spento. Ad eccezione dell'orologio, che viene azzerato, tutti gli altri parametri rimangono in memoria anche in caso di scollegamento della batteria.

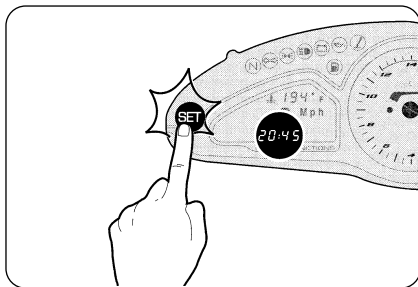
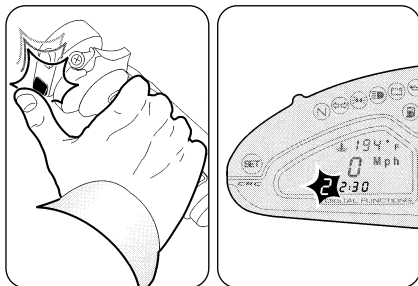



4.4.5. Cronometro

► L'attivazione del cronometro è possibile solamente se sul display è visualizzata una delle seguenti funzioni:

- Contachilometri Totale "TOTAL"
- Contachilometri Parziale 1 "TRIP 1"
- Contachilometri Parziale 2 "TRIP 2"
- Orologio

► Premere contemporaneamente il pulsante "SET" ed il pulsante di avviamento motore per almeno 2 secondi. In questo modo si attiva la funzione cronometro. Sul display vengono visualizzate le cifre "00:00.0".



ATTENZIONE

Le operazioni di modifica o regolazione delle funzioni display devono essere eseguite con motore acceso, cambio in folle, motocicletta ferma e piedi a terra. È vietato cambiare le impostazioni del display durante la marcia.

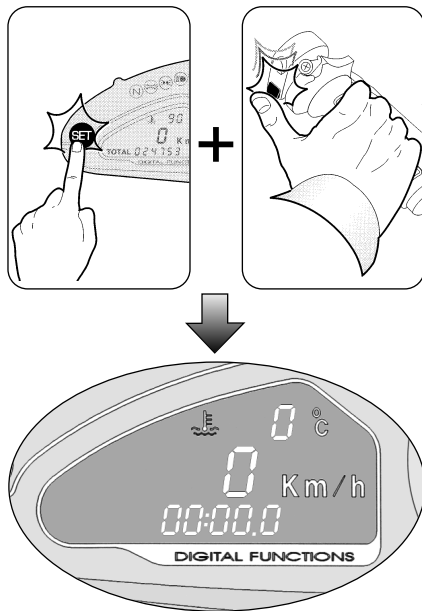

4



□ Acquisizione Dati

Dopo aver attivato la funzione cronometro è possibile iniziare l'acquisizione dei dati azionando il pulsante del lampeggio faro abbagliante. L'esecuzione di tale operazione determina l'inizio della misurazione dei tempi. I puntini che separano i minuti dai secondi e dai decimi di secondo iniziano a lampeggiare. Lo strumento sta acquisendo i tempi.

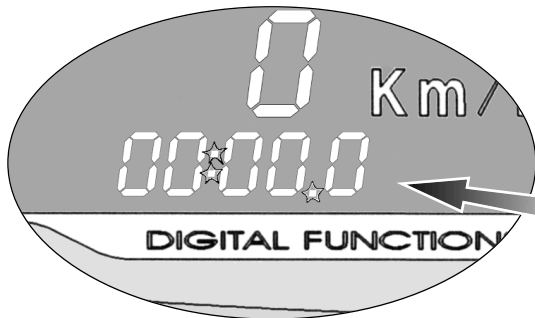
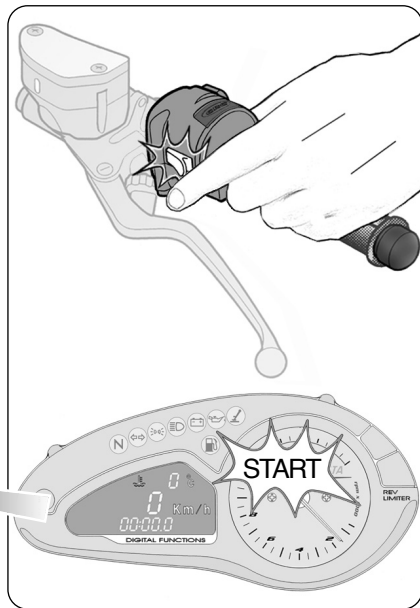



Premendo nuovamente il pulsante del lampeggio fanale abbagliante viene registrata la misurazione del tempo relativo al 1° giro percorso. Contemporaneamente lo strumento inizia ad acquisire il tempo relativo al secondo giro.

La misurazione del tempo relativo al primo giro viene conservata in memoria e rimane visualizzata sul display sino all'acquisizione del giro successivo.

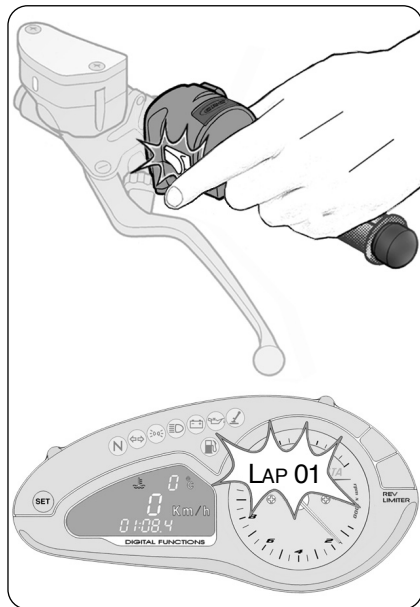



Continuando nell'utilizzo del cronometro, ad ogni azionamento del pulsante di lampeggio viene registrato un tempo.

Lo strumento ha la possibilità di eseguire un numero massimo di 80 memorizzazioni consecutive.

Nel caso in cui il tempo del giro appena rilevato fosse inferiore al tempo misurato durante il giro precedente, lo strumento visualizza il simbolo “ - ” davanti alle cifre.

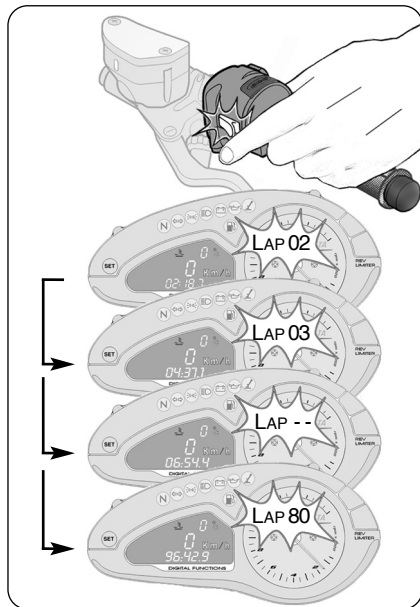
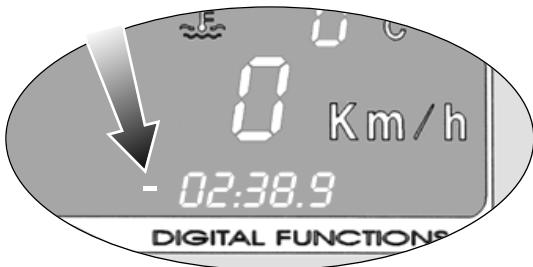



Visualizzazione dei Dati

Terminata la fase di acquisizione tempi è possibile eseguire la visualizzazione.

NOTA

Prestare attenzione a non spegnere il motore del veicolo. Un eventuale spegnimento del motore provocherebbe la perdita di tutti i dati memorizzati.

- Premere il pulsante SET per un tempo compreso tra 0,25 e 2 secondi.

NOTA

Premendo il pulsante SET per un tempo superiore ai 2 sec. vengono cancellati tutti i dati memorizzati.

- Sul display compare la scritta "LAP 01"; dopo 1 secondo compare il tempo corrispondente al 1° giro memorizzato.

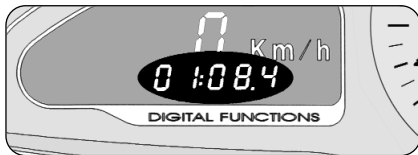
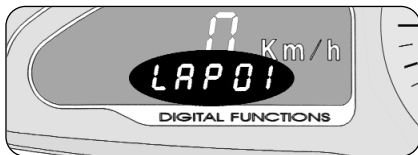
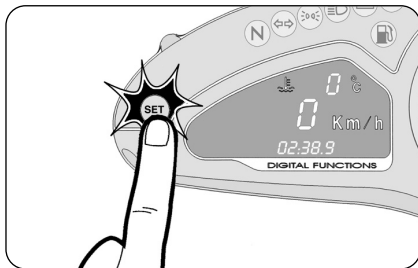

4



► Azionando il pulsante del lampeggio fanale abbagliante, sul display compare la scritta "LAP 02"; dopo 1 secondo compare il tempo corrispondente al 2° giro memorizzato.

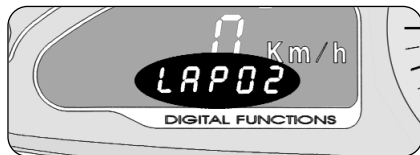
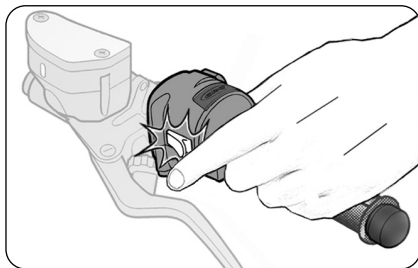

► Continuando a premere il pulsante di lampeggio, compaiono di volta in volta i dati dei giri successivi. Dopo la visualizzazione dei dati dell'ultimo giro memorizzato, premendo nuovamente il pulsante di lampeggio si ritorna alla visualizzazione dei dati del 1° giro ("LAP 01").

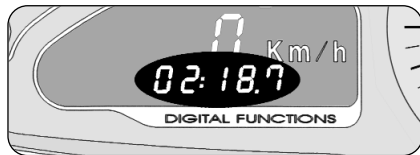



Visualizzazione dei dati del giro più veloce

- ▶ Assicurarsi che il display si trovi nella modalità di visualizzazione dati, e che su di esso compaia il tempo relativo al 1° giro memorizzato ("LAP 01").
- ▶ Premere il pulsante "SET" per un tempo uguale o superiore a 2 secondi.

NOTA

Premendo il pulsante "SET" per un tempo inferiore ai 2 secondi si esce dalla modalità visualizzazione dati.

- ▶ Sul display compare il numero del giro in cui è stato registrato il miglior tempo; dopo 1 secondo compare il tempo corrispondente.

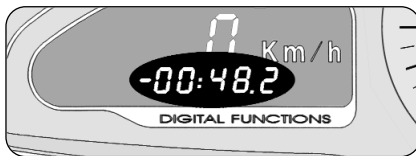
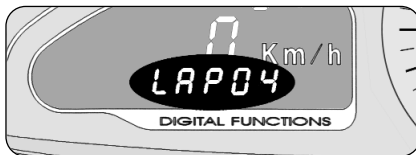
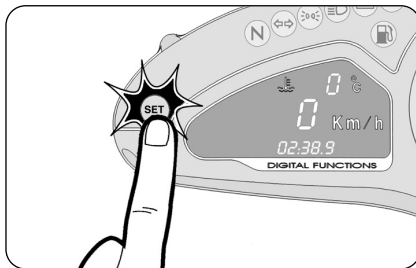



□ Ritorno alla modalità acquisizione dati

► Premendo il pulsante “SET” per un tempo compreso tra 0,25 e 2 secondi, si ritorna alla modalità di acquisizione dati; in questo modo è possibile continuare ad acquisire tempi, o cominciare una nuova sessione di cronometraggio.

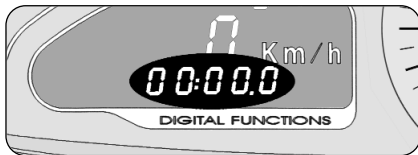
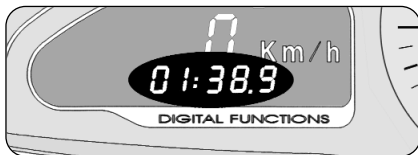
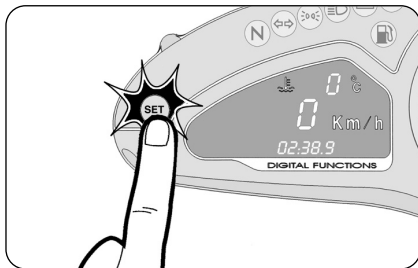

4

► Dopo avere premuto il pulsante “SET”, sul display vengono visualizzati i dati relativi all’ultimo giro memorizzato.

NOTA

Ritornando alla modalità acquisizione dati, se in precedenza non è stato memorizzato alcun dato, sul display verrà visualizzata la scritta “00:00.0”.



❑ Cancellazione dei dati

L'operazione di cancellazione di tutti i dati memorizzati si esegue premendo per 2 secondi il tasto "SET".

NOTE

Una volta cancellati i dati non sono più recuperabili. L'operazione di pulizia dei dati può essere eseguita anche durante le fasi in cui il cronometro è attivo. In tali situazioni viene interrotta l'operazione di cronometraggio.

A cancellazione avvenuta il cronometro visualizzerà le cifre "00:00.0".

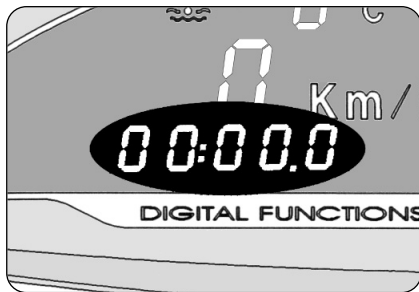
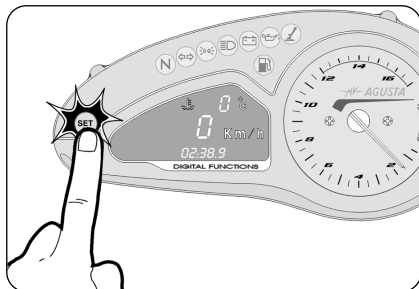



4.5. Rifornimento carburante



Pericolo - Attenzione: la benzina e i suoi vapori sono estremamente infiammabili e nocivi. Evitare il contatto e l'inalazione. Durante il rifornimento spegnere il motore, non fumare, tenere lontane fiamme, scintille e fonti di calore. Effettuate il rifornimento all'aperto o in locale ben ventilato.



Cautela - Precauzione: utilizzare esclusivamente benzina super senza piombo con un numero di ottano (R.O.N.) di 95 o più. Tale necessità è ricordata da un punto verde sul lato inferiore del tappo serbatoio.

- ▶ Sollevare il coperchio parapolvere.
- ▶ Inserire la chiave, ruotarla in senso orario e sollevare il tappo.
- ▶ Dopo il rifornimento premere il tappo verso il basso ruotando contemporaneamente la chiave in senso orario per facilitare la chiusura. Quindi rilasciare la chiave ed estrarla.

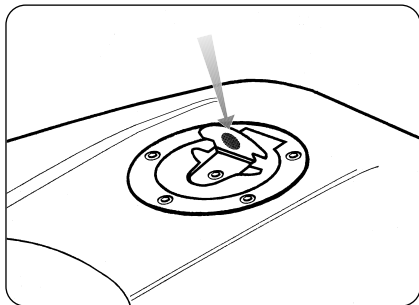
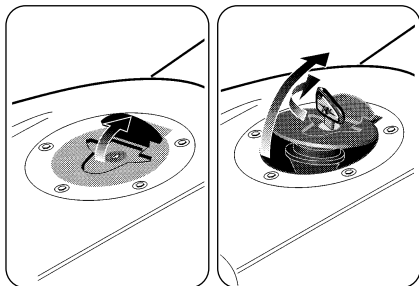

**ATTENZIONE**

Un riempimento eccessivo del serbatoio può far traboccare il carburante a causa dell'espansione dovuta al calore del motore o all'esposizione della motocicletta alla luce solare. Eventuali fuoriuscite di carburante possono provocare incendi. Il livello del carburante nel serbatoio non deve mai superare la base del bocchettone di riempimento.



Cautela-Precauzione: asciugare subito con un panno pulito l'eventuale carburante versato, in quanto può deteriorare le superfici verniciate o di plastica.

**ATTENZIONE**

Verificare che il tappo del serbatoio del carburante sia chiuso correttamente prima di utilizzare il motociclo.

4

4.6. Accesso al vano portaoggetti

- ▶ Inserire la chiave.
- ▶ Premere il codone nella parte terminale e contemporaneamente ruotare la chiave in senso orario.
- ▶ Sollevare leggermente il codone dall'estremità posteriore; farlo scorrere all'indietro e completare il sollevamento fino al contatto col serbatoio carburante.

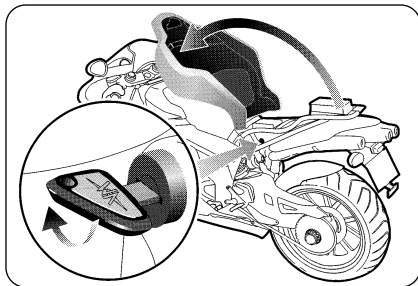



4.7. Sosta della motocicletta

☐ Sosta con cavalletto laterale



CAUTELA

- Parcheggiare la motocicletta in condizioni di sicurezza e su terreno stabile.
- Per la sosta in pendenza parcheggiare con la ruota anteriore a monte e con la prima marcia inserita; ricordarsi di riportare il cambio in folle prima di riavviare la moto.
- Non lasciare il veicolo incustodito con la chiave di accensione inserita nel quadro.

► Abbassare il cavalletto col piede fino alla battuta ed inclinare lentamente la motocicletta per porre il piedino di appoggio in contatto col suolo.

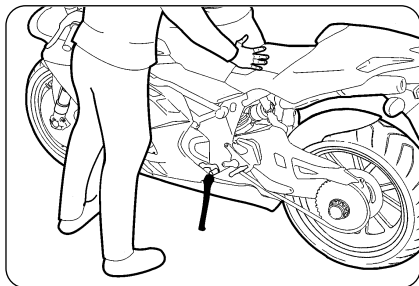

**ATTENZIONE**

Quando il veicolo è in sosta sul cavalletto laterale, è pericoloso sedere a bordo gravando perciò col proprio peso sull'unico appoggio di stazionamento.

**ATTENZIONE**

Prima di mettersi in marcia verificare il funzionamento dell'interruttore di sicurezza accertandosi che la spia di apertura cavalletto laterale sul cruscotto si spenga; in ogni caso verificare che il cavalletto sia rientrato.

Se si nota una disfunzione, fare controllare l'impianto da un concessionario MV Agusta prima di utilizzare il mezzo.

□ Sosta con cavalletto posteriore

Inserire il perno del cavalletto nel foro dell'asse ruota posteriore dal lato sinistro della motocicletta; appoggiare il cavalletto al suolo e facendo forza su di esso sollevare il veicolo fino al raggiungimento della condizione di stabilità.

**CAUTELA**

Questa operazione deve essere eseguita da due persone.

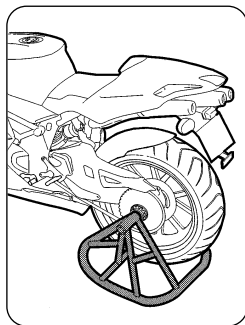
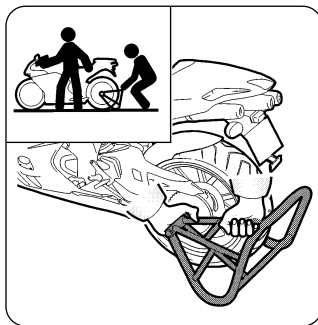



5.1. Elenco regolazioni

La motocicletta possiede un'ampia possibilità di regolazioni che possono migliorare l'ergonomia, l'assetto e la sicurezza.

Tuttavia, poiché una errata regolazione di componenti particolarmente importanti può creare una situazione di pericolo, alcune di queste regolazioni sono riservate soltanto ai Centri Assistenza MV Agusta.



ATTENZIONE

Tutte le regolazioni devono essere effettuate a veicolo fermo.



(F) Regolazione specchietto retrovisore (§5.5.)

(A) Regolazione leva frizione (§5.4.)

(F) Regolazione specchietto retrovisore (§5.5.)

(C) Regolazione pedana
destra (§5.2.)

(E) Regolazione leva freno
posteriore (§5.2.)

(B) Regolazione leva freno
anteriore (§5.3.)

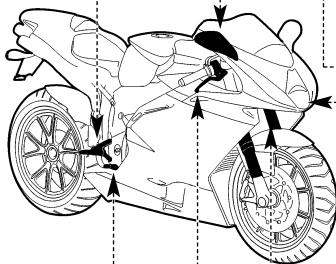

(H) Regolazione sospensione
anteriore (§5.7.)

(G) Regolazione ammortizzatore
di sterzo (§5.6.)

(D) Regolazione leva
cambio (§5.2.)

(L) Regolazione sospensione
posteriore (§5.8.)

(N) Orientamento
faro (§5.9.)

(M) Regolazione
catena (§5.2.)

(C) Regolazione pedana
sinistra (§5.2.)

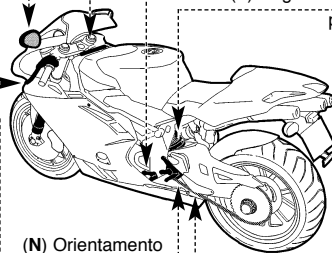



5.2. Tabella delle regolazioni



A - Regolazione leva frizione: per ottimizzare la presa in funzione delle esigenze del motociclista (§5.4).



B - Regolazione leva freno anteriore: per ottimizzare la presa in funzione delle esigenze del motociclista (§5.3).



C - Regolazioni pedane poggipiedi (destra e sinistra) : per ottimizzare la posizione dei piedi in funzione delle esigenze del motociclista.



D - Regolazione leva cambio: per ottimizzare il movimento del comando in funzione delle esigenze del motociclista.



E - Regolazione leva freno posteriore: per ottimizzare il movimento del comando in funzione delle esigenze del motociclista.



F - Regolazione specchietti retrovisori: per ottimizzare l'orientamento (§5.5).



G - Regolazione ammortizzatore di sterzo: per adattare la durezza dello sterzo alle preferenze di guida del motociclista (§5.6).



H - Regolazione sospensione anteriore: per adattare la risposta alle preferenze del motociclista si possono regolare:

- precarico molla (§5.7.1.)
- dispositivo idraulico di frenatura in estensione (§5.7.2.)
- dispositivo idraulico di frenatura in compressione (§5.7.3.)



L - Regolazione sospensione posteriore: per adattare la risposta alle preferenze del motociclista si possono regolare:

- altezza assetto
- precarico molla (§5.8.1.)
- dispositivo idraulico di frenatura in estensione (§5.8.2.)
- dispositivo idraulico di frenatura in compressione per alte velocità (§5.8.3.)
- dispositivo idraulico di frenatura in compressione per basse velocità (§5.8.4.)



M - Regolazione catena: per l'efficienza e la sicurezza della trasmissione.



N - Orientamento faro: per regolare la profondità del fascio luminoso in funzione dell'assetto (§5.9).



5.3. Regolazione leva freno anteriore

Tirare la leva per neutralizzare la spinta della molla e, contemporaneamente, regolarne la posizione ruotando la ghiera in senso orario o antiorario. In senso orario: la leva si allontana dalla manopola. In senso antiorario: la leva si avvicina alla manopola.

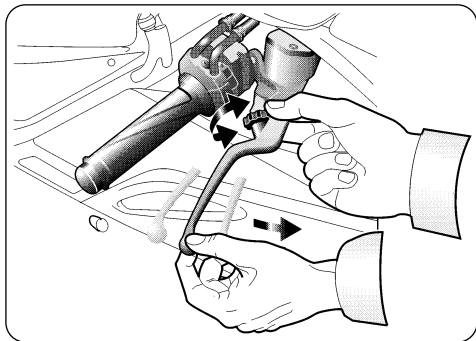

5.4. Regolazione leva frizione

Tirare la leva per neutralizzare la spinta della molla e, contemporaneamente, regolarne la posizione ruotando la ghiera in senso orario o antiorario. In senso orario: la leva si allontana dalla manopola. In senso antiorario: la leva si avvicina alla manopola.

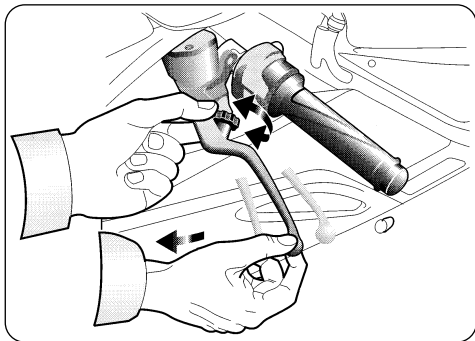



5.5. Regolazione specchietti retrovisori

Premere nei punti evidenziati per regolare la posizione nelle quattro direzioni.

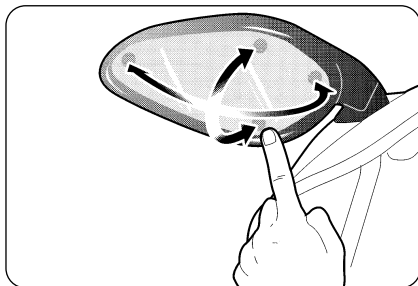

5

5.6. Regolazione ammortizzatore di sterzo

La regolazione standard si ottiene ruotando il pomello in senso antiorario fino a fondo corsa; in questa posizione l'ammortizzatore offre la minima resistenza all'azione dello sterzo.

In base alle proprie esigenze di guida è possibile aumentare gradualmente l'azione frenante dell'ammortizzatore di sterzo ruotando il pomello in senso orario.

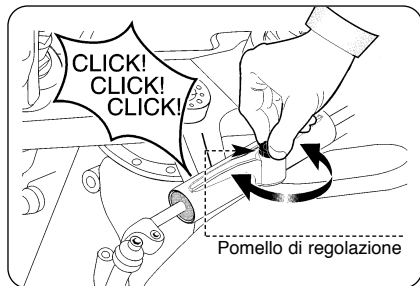



5.7. Regolazione sospensione anteriore

**ATTENZIONE**

È essenziale che i registri di entrambi gli steli della forcella siano regolati nella stessa posizione.

NOTA

La regolazione delle sospensioni deve essere preferibilmente effettuata con il serbatoio carburante pieno.

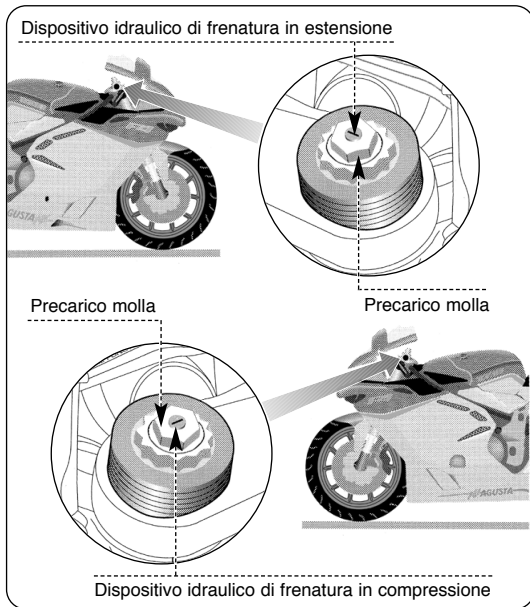



5.7.1. Precarico molla (sospensione anteriore)

La regolazione deve essere effettuata partendo dalla posizione standard. Per trovare tale posizione, occorre ruotare in senso antiorario fino a fondo corsa, quindi in senso orario fino alla posizione standard (vedi tabella allegata). Ruotare in senso orario per aumentare il precarico molla, oppure ruotare in senso antiorario per diminuirlo.

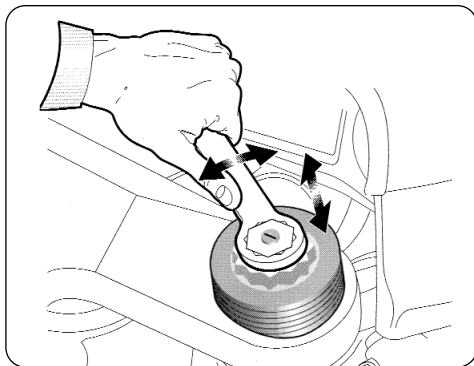

5.7.2. Dispositivo idraulico di frenatura in estensione (sospensione anteriore)

La regolazione deve essere effettuata partendo dalla posizione standard. Per trovare tale posizione, occorre ruotare in senso orario fino a fondo corsa, quindi in senso antiorario fino alla posizione standard (vedi tabella). Ruotare in senso orario per aumentare l'azione frenante, oppure ruotare in senso antiorario per diminuirla.

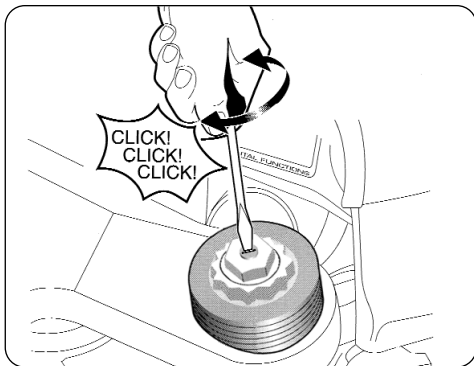



5.7.3. Dispositivo idraulico di frenatura in compressione (sospensione anteriore)

La regolazione deve essere effettuata partendo dalla posizione standard. Per trovare tale posizione, occorre ruotare in senso orario fino a fondo corsa, quindi in senso antiorario fino alla posizione standard (vedi tabella). Ruotare in senso orario per aumentare l'azione frenante, oppure ruotare in senso antiorario per diminuirla.

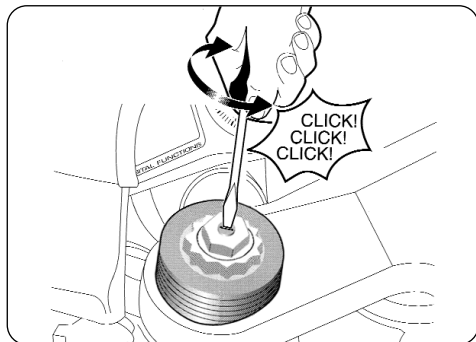



5.8. Regolazione sospensione posteriore



ATTENZIONE: L'alta temperatura dei tubi di scarico può provocare scottature. Spegner il motore ed attendere che i tubi di scarico si siano raffreddati prima di effettuare la regolazione.



ATTENZIONE: L'ammortizzatore contiene gas ad alta pressione. Non tentare in alcun modo di effettuarne lo smontaggio.



CAUTELA: Per valutare la taratura della sospensione posteriore non agire in nessun modo sui terminali di scarico. Essi sarebbero sicuramente soggetti a danneggiamento.

NOTA: Al momento della consegna, la sospensione posteriore viene regolata nella configurazione standard (vedi tabella allegata).

NOTA: La regolazione delle sospensioni deve essere preferibilmente effettuata con il serbatoio carburante pieno.

5

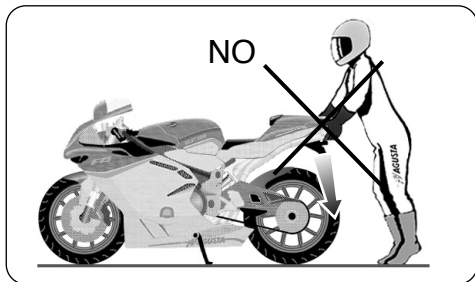
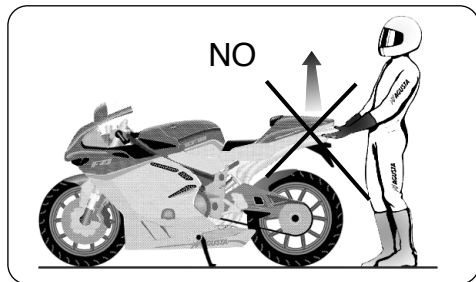

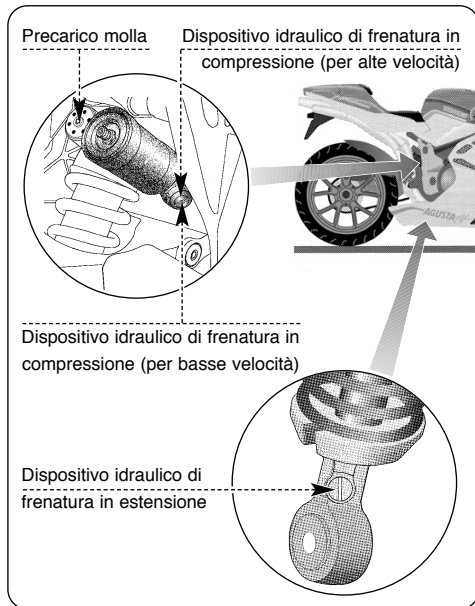

5.8.1. Precarico molla (sospensione posteriore)

La regolazione deve essere effettuata partendo dalla posizione standard. Per trovare tale posizione, occorre ruotare in senso antiorario fino a fondo corsa, quindi in senso orario fino alla posizione standard (vedi tabella allegata). Ruotare in senso orario per aumentare il precarico molla, oppure ruotare in senso antiorario per diminuirlo.



CAUTELA: Non ruotare il registro del precarico molla oltre la posizione di fondo corsa in senso orario o antiorario per evitare il danneggiamento del dispositivo.

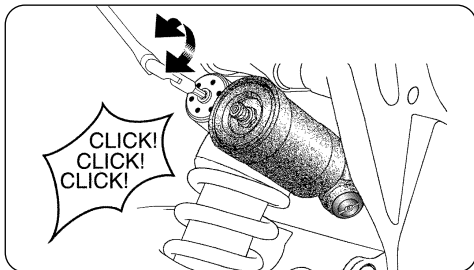

5



5.8.2. Dispositivo idraulico di frenatura in estensione (sospensione posteriore)

La regolazione deve essere effettuata partendo dalla posizione standard. Per trovare tale posizione, occorre ruotare in senso orario fino a fondo corsa, quindi in senso antiorario fino alla posizione standard (vedi tabella). Ruotare in senso orario per aumentare l'azione frenante, oppure ruotare in senso antiorario per diminuirla.

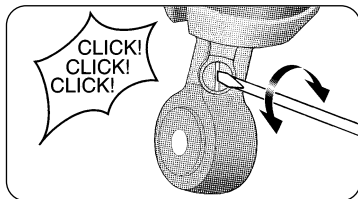

5.8.3. Dispositivo idraulico di frenatura in compressione per alte velocità (sospensione posteriore)

La regolazione deve essere effettuata partendo dalla posizione standard. Per trovare tale posizione, occorre ruotare in senso antiorario fino a fondo corsa, quindi in senso orario fino alla posizione standard (vedi tabella). Ruotare in senso orario per aumentare l'azione frenante, oppure ruotare in senso antiorario per diminuirla.



5.8.4. Dispositivo idraulico di frenatura in compressione per basse velocità (sospensione posteriore)

La regolazione deve essere effettuata partendo dalla posizione standard. Per trovare tale posizione, occorre ruotare in senso orario fino a fondo corsa, quindi in senso antiorario fino alla posizione standard (vedi tabella). Ruotare in senso orario per aumentare l'azione frenante, oppure ruotare in senso antiorario per diminuirla.

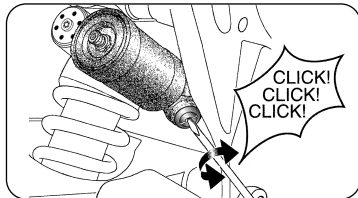



5.9. Regolazione proiettore anteriore

Porre il veicolo a 10 metri di distanza da una parete verticale.

Assicurarsi che il terreno sia piano e che l'asse ottico del proiettore sia perpendicolare alla parete.

Il veicolo deve trovarsi in posizione verticale. Misurare l'altezza del centro del proiettore da terra e riportare sulla parete una crocetta alla medesima altezza.

Accendendo la luce anabbagliante, il limite superiore di demarcazione tra la zona oscura e la zona illuminata deve risultare ad un'altezza non superiore a $9/10$ dell'altezza da terra del centro del proiettore.

Per la regolazione del faro il range di valori é di $\pm 4^\circ$.

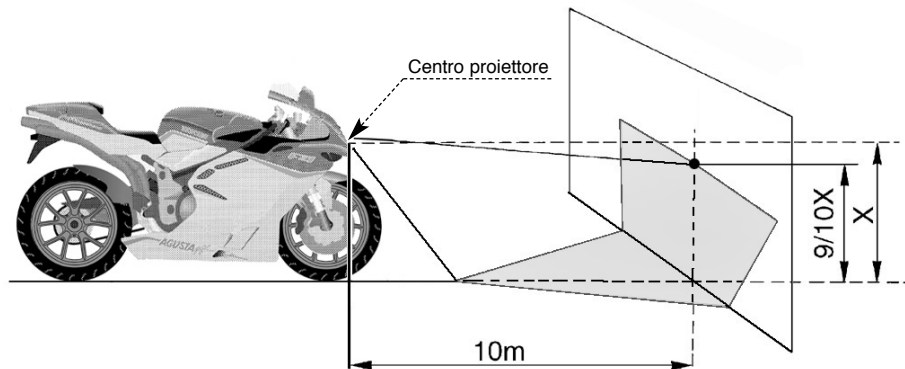



Nota informativa

MV Agusta S.p.A. è impegnata in una politica di continuo miglioramento dei propri prodotti; per questa ragione potrebbe essere possibile riscontrare leggere differenze tra quanto riportato nel presente documento ed il veicolo da Voi acquistato. I modelli MV Agusta vengono esportati in numerosi Paesi, nei quali valgono norme differenti in relazione al Codice della Strada ed alle procedure di omologazione. Contando sulla Vostra comprensione, MV Agusta S.p.A. ritiene quindi necessario riservarsi il diritto di apportare modifiche ai propri prodotti ed alla propria documentazione tecnica in qualsiasi momento e senza fornirne preavviso.

Vi consigliamo di visitare periodicamente il sito Internet www.mvagusta.it per ottenere informazioni ed aggiornamenti sui prodotti MV Agusta e sulla relativa documentazione.



Rispettiamo e difendiamo l'ambiente

Tutto ciò che facciamo ha ripercussioni sull'intero pianeta e sulle sue risorse.

MV Agusta, a tutela degli interessi della comunità, sensibilizza i Clienti e gli operatori dell'assistenza tecnica ad adottare modalità d'uso del mezzo e di smaltimento di sue parti, nel pieno rispetto delle normative vigenti in termini di inquinamento ambientale, smaltimento e riciclaggio dei rifiuti.

5

© 2007

È vietata la riproduzione anche parziale di questo documento senza il consenso scritto della MV Agusta S.p.A.

Part. n° 8000B1113

Edizione n° 1 - Novembre 2007

MV AGUSTA



User's manual
English Version

BIERA
100

Dear Customer,

We wish to thank you for your preference and congratulate you on purchasing your new F4 312. Your choice is a reward for the passionate effort our technicians have put into giving the F4 312 functional and aesthetic characteristics that place it above the finest motorcycles currently available on the market, making it an exclusive and sought-after item.

If, from a purely technical standpoint, the F4 312 represents an internationally recognized point of reference on account of the innumerable innovations it introduces, its sleek, timeless design wonderfully combines a glorious past with the new millennium.

The combination of these elements, which was made possible by love of detail, passion, and the desire to realize a technically and aesthetically superior motorcycle, allows the F4 312 to soar above passing fashions, giving it the privilege of being considered a unique item.

For further information, please feel free to contact the MV Agusta Customer Care Service.

Have a good time!

*MV Agusta
Claudio Castiglioni
Chairman*



CONTENTS

<i>chap.</i>	<i>Subjects covered</i>	<i>page</i>
1	GENERAL INFORMATION	5
1.1.	Purpose of the manual	5
1.2.	Symbols	6
1.3.	Contents of the CD-Rom	7
1.4.	Identification data	8
2	SAFETY INFORMATION	10
2.1.	Allowed use of the vehicle	10
2.2.	Maintenance	10
2.3.	Accessories and modifications	11
2.4.	Vehicle load	11
3	CONTROLS AND INSTRUMENTS	13
3.1.	Location of controls and instruments	13
3.2.	Sidestand	14
3.3.	Handlebar controls, left side	15
3.4.	Handlebar controls, right side	17
3.5.	Ignition switch and steering lock	20
3.6.	Gear lever	22
3.7.	Instruments and warning lights	23
3.7.1.	Warning lights	24
3.7.2.	Multifunction display	25
3.8.	Table of lubricants and fluids	26

<i>chap.</i>	<i>Subjects covered</i>	<i>page</i>
4	OPERATION	27
4.1.	Using the motorcycle	27
4.2.	Running-in	28
4.3.	Starting the engine	30
4.4.	Selecting and setting the display functions	32
4.4.1.	Selecting the display functions	33
4.4.2.	Setting the measurement units	35
4.4.3.	Resetting the trip mileage counters	38
4.4.4.	Setting the clock	41
4.4.5.	Chronometer	43
4.5.	Refuelling	52
4.6.	Glove compartment	53
4.7.	Parking the motorcycle	54
5	ADJUSTMENTS	56
5.1.	List of adjustments	56
5.2.	Table of adjustments	58
5.3.	Adjusting the front brake lever	59
5.4.	Adjusting the clutch lever	59
5.5.	Adjusting the rearview mirrors	60
5.6.	Adjusting the steering damper	60



CONTENTS

<i>chap.</i>	<i>Subjects covered</i>	<i>page</i>
5.7.	Adjusting the front suspension	61
5.7.1.	Spring preload (front suspension)	62
5.7.2.	Rebound damper (front suspension)	62
5.7.3.	Compression damper (front suspension)	63
5.8.	Adjusting the rear suspension	64
5.8.1.	Spring preload (rear suspension)	65
5.8.2.	Rebound damper (rear suspension)	66
5.8.3.	High speed compression damper (rear suspension)	66
5.8.4.	Low speed compression damper (rear suspension)	66
5.9.	Headlight adjustment	67



1.1. Purpose of the manual

This User's Manual contains the necessary information for a correct and safe use of the motorcycle.

Together with this manual, a pocket Quick Manual is also supplied, in which the minimum essential informations for the use of the vehicle are reported.

The User's Manual is also supplied in electronic format (.pdf) on this CD-Rom and it can be printed or viewed on any PC, equipped either with Windows or Mac operative system.

We recommend to carefully read the User's Manual before using your motorcycle, and to make sure that anyone who uses the motorcycle had previously made the same.

Finally, we recommend to always take with you the Quick Manual, after having filled it in with your personal ID data and the specifications of your motorcycle.

1 GB



Copyright
MV AGUSTA Motor Spa
All rights reserved



1.2. Symbols

Sections of text that are particularly important in terms of personal safety or possible damage to the motorcycle are marked with the following symbols:



Danger - Failure to observe these prescriptions, even in part, may pose a serious hazard to the driver's and other people's safety.



Caution - Failure to observe these prescriptions, even in part, may result in damage to the motorcycle.

The following symbols give an indication of who is supposed to perform the different adjustments and/or maintenance operations:



Information on operations that can be carried out by the user.



Information on operations that must be carried out only by authorized personnel.

The following symbols are used to provide further information:



The “” symbol points out the requirement to use a tool or a special equipment in order to correctly perform the described operation.



The “§” symbol refers the reader to the chapter identified by the number that follows.



1.3. Contents of the CD-Rom

Inside the CD-Rom supplied you will find, besides the User's Manual, the Maintenance Manual, the Quick Manual (which is also supplied in a paper copy), the World Dealer Guide and the Warranty Booklet.

When delivering the bike, your Dealer has also supplied the Warranty and Pre-Delivery Certificate.

We recommend to keep it together with the motorcycle documents and with the service coupons that are given at the moment of servicing the bike.

IMPORTANT

The copy of the Warranty and Pre-Delivery Certificate to be sent to MV Agusta must be filled in by the dealer and returned to the factory within 10 days from the date of registration.

The dealer must always fill in the service coupon and return it to MV Agusta within 10 days from the date of the servicing.

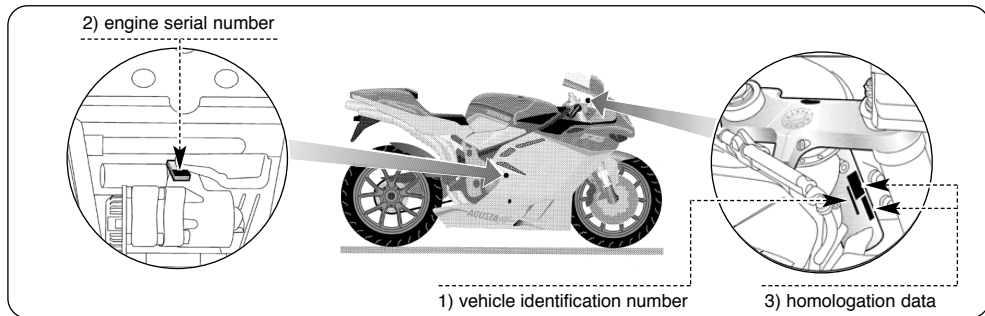
GB
1

1.4. Identification data

- 1) vehicle identification number
- 2) engine serial number
- 3) homologation data

► Motorcycle identification

The motorcycle is identified by the vehicle identification number. When placing orders for spare parts, in addition to this number, you may be required to provide the engine serial number, the color code and the key identification.

We recommend writing down the main numbers in the spaces provided below.

FRAME No.: _____

ENGINE No.: _____



► Motorcycle key identification

A key is supplied in duplicate for both the ignition and all the locks. Keep the duplicate in a safe place.

When placing orders for spare keys, you may be required to provide the key identification number. We recommend writing down this number in the space provided below:

KEY No.: _____

► Identification of motorcycle colour combination

The colour code must be mentioned when ordering body spares. This code can be read on the label placed on the internal side of the tail piece.

We recommend writing down the colour code in the space provided below:

COLOUR CODE : _____

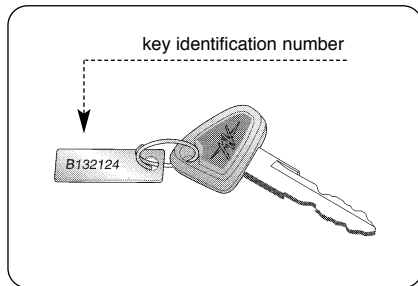

1 GB

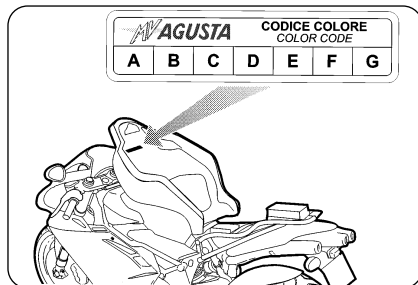



2.1. ALLOWED USE OF THE VEHICLE

Your motorcycle has been strictly designed for use on road or highway route.



WARNING

Occasionally, it is possible to use your motorcycle on race track during non-competitive events.

In this case, however, in consequence of the higher stresses affecting the bike during this specific use, we recommend to have its conditions checked by an authorized MV Agusta Service Center before and after using it.

Any other use of the vehicle is prohibited and explicitly excluded.

You can find further information about the use of the vehicle in the section no. 4 of this Manual.

2.2. MAINTENANCE

In order to guarantee the maximum efficiency and reliability of the vehicle, it is necessary to perform the programmed maintenance operations reported in the Maintenance Manual.

MV Agusta recommends that all maintenance operations are performed only by skilled personnel from an authorized MV Agusta Service Center. Anyway, if you decide to have the maintenance operations performed by non-authorized workshops, you must ensure that they have the skills and the specific tools necessary to perform the above operations.



WARNING

The MV Agusta Warranty could not be valid if non-authorized workshops had performed operations on the bike in a different way from what is described on the Technical Circular Letters and on the related MV Agusta Workshop Manuals.



2.3. ACCESSORIES AND MODIFICATIONS



WARNING

MV Agusta prohibits to make any modification to its motorcycles.

This is necessary to preserve the safety of its Customers.

Anyway, it is possible to customize your motorcycle by consulting the extensive MV Agusta Accessory Catalogue.



WARNING

The installation of some of the above accessories could invalidate the bike homologation, and consequently make the bike not furtherly usable on public roads.

If you have doubts, we suggest to refer to your MV Agusta Dealer in order to choose the accessories which can better suit your needs.

2.4. VEHICLE LOAD

The **F4 1078 RR 312** and **F4 1000 R 312** versions are designed for use by the rider only, whereas the **F4 1078 RR 1+1 312** and **F4 1000 R 1+1 312** versions can also seat a passenger. To use the vehicle in complete safety and in accordance with the Highway Code provisions, it is compulsory that the following maximum load conditions are never exceeded:

F4 1078 RR 312 / F4 1000 R 312

Maximum total weight **340 kg**

Maximum load weight **110 kg**

F4 1078 RR 1+1 312 / F4 1000 R 1+1 312

Maximum total weight **420 kg**

Maximum load weight **180 kg**



The maximum total weight comes out from the sum of the following weights, according to the European standard CEE 92/61:

- weight of the motorcycle;
- weight of the driver;
- weight of the passenger (for F4 1078 RR 1+1 312 and F4 1000 R 1+1 312 only);
- weight of the load and all the accessories.

**WARNING**

Since the load can strongly affect handling, braking, performance and safety characteristics of your motorcycle, you should always keep in mind the following warnings.

- **NEVER OVERLOAD YOUR MOTORCYCLE!** Driving an overloaded motorcycle can cause damage to the tyres, loss of control of the vehicle and serious injury. Verify that the total weight (including the weight of the motorcycle, the driver, the passenger, the load and all the accessories) does not exceed the maximum load value specified for your vehicle.



3.1. Location of controls and instruments

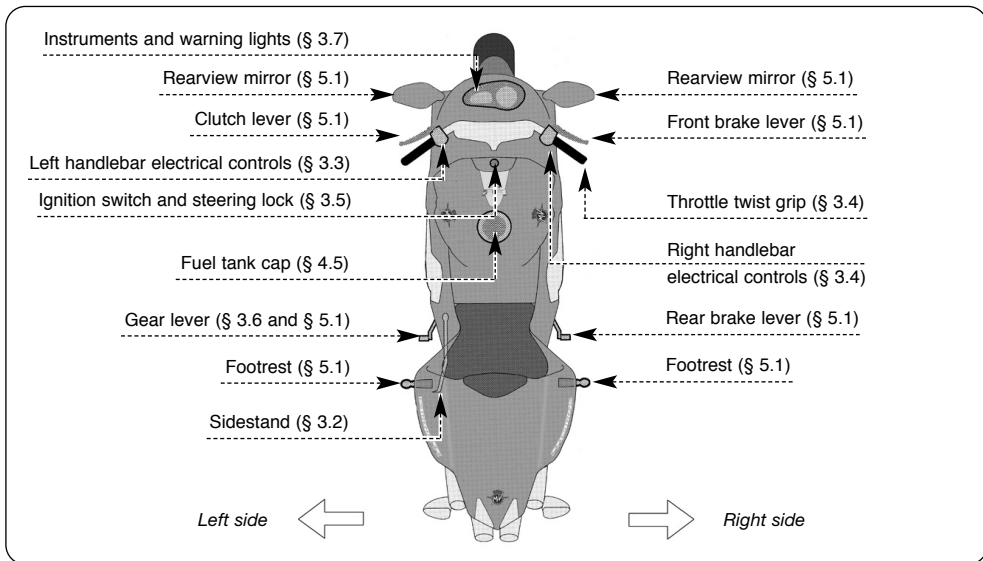

3 GB



3.2. Sidestand

The sidestand is equipped with a safety switch that prevents the motorcycle from moving off while the stand is down.

If the rider attempts to engage the gears while the engine is running and the stand is down, the switch automatically turns off the engine by cutting the current supply.

If the motorcycle is parked (side-stand down) and the gears are engaged, the switch prevents the engine from being started, thereby avoiding the risk of accidentally toppling the vehicle.

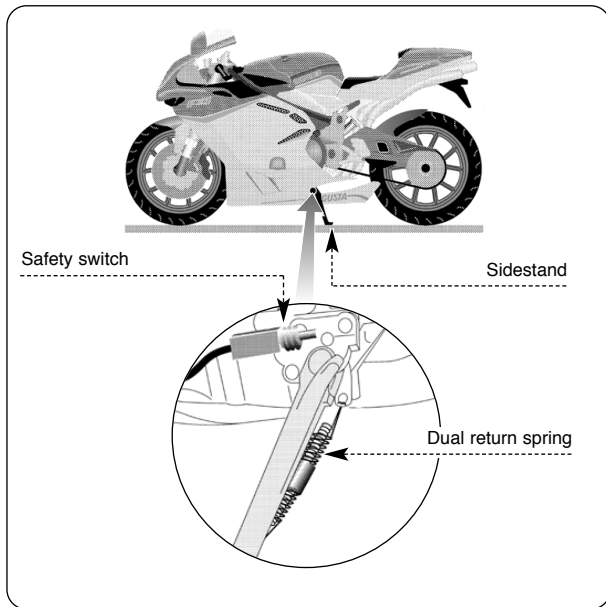

GB 3

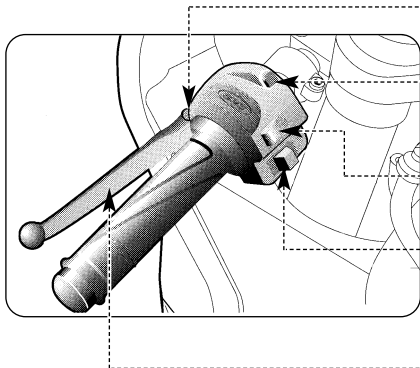
**3.3. Handlebar controls, left side****High beam flasher button**

Press the button repeatedly.

Low/high beam button

Button not pressed in  : low beam

Button pressed in  : high beam

Horn button

Press to operate the warning horn.

Turn indicator switch

Shifting the lever to the left or right switches on the left or right turn indicators. The switch then returns to the central position. Press to turn off the indicators.

Clutch lever

Move towards/away from the handgrip to release/engage the clutch.



High beam flasher button

It is used to attract the attention of other road users in case of danger. When the high beam is on, the function is inactive.

Low/high beam button

Under normal conditions, the low beam is on. The high beam can be switched on by pressing the button when allowed by the traffic and road conditions.

Horn button

It is used to attract the attention of other road users in case of danger.

Turn indicator switch

It is used to show the rider's intention to change direction or lane.



WARNING

Failure to switch the turn indicators on or off at the right time may cause an accident in that the other road users may draw incorrect conclusions about the direction of motion of the vehicle. Always switch on the indicators before turning or changing lanes. Then be sure to switch off the indicators after completing the operation.

Clutch lever

It engages/disengages the clutch through a hydraulically controlled device.

**3.4. Handlebar controls, right side****Engine stop switch**

Stops the engine and prevents it from being restarted.

Engine start button

Starts the engine. To be released as soon as the engine starts. When the engine is running, pressing the button selects the display functions.

Cold start (choke) lever

Rotate clockwise when cold starting. After the engine has run for a few seconds, return the lever to its original position.

Throttle twist grip

Rotate counterclockwise to increase engine speed.

Front brake lever

Pull to the lever to apply the front brake.

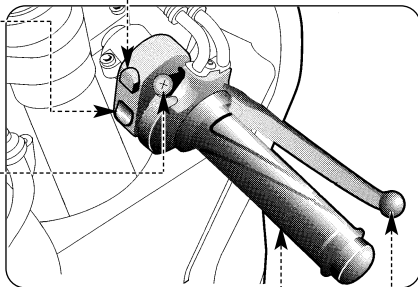



Engine stop switch

It is used to switch off the engine in an emergency. The ignition circuit is disabled, preventing the engine from being restarted. To be able to restart the engine, return the switch to its original position.

NOTE

Under normal conditions, do not use this switch to shut off the engine.

Engine start button

It is used to start the engine and, when the engine is running, to select the different functions of the display installed on the instrument panel.



CAUTION

To avoid damaging the electrical equipment, be sure not to hold down the button for longer than 5 consecutive seconds.

If, after some attempts, the engine does not start, refer to the chapter “TROUBLESHOOTING” later in this manual.

Cold start (choke) lever

It facilitates cold starting by slightly enrichening the fuel-air mixture during start-up.

NOTE

This function must remain active only for a short time depending on the engine and environmental temperature. As soon as the idle speed keeps the engine running, it is advisable to disable the control.

**Throttle twist grip**

It controls the fuel-air mixture supplied to the engine, which regulates engine speed. To increase engine speed, rotate the hand grip from its idle position counterclockwise.

When cold starting (choke on), rotating the throttle twist grip clockwise fully and repeatedly causes the choke lever to return to its original position.

Front brake lever

It controls a hydraulic circuit that operates the front wheel braking system.



3.5. Ignition switch and steering lock

**WARNING**

Do not attach a ring or any other object to the ignition key as they may hinder the steering action.

**WARNING**

Never attempt to change the switch functions while riding, as you may lose control of the vehicle.

The ignition switch enables and disables the electrical circuit and the steering lock. The four positions of the switch are described below.

OFF position

All electrical circuits are deactivated. The key can be removed.

ON position

All electrical circuits are activated. The instruments and warning lights perform the self-diagnostic cycle. The engine can be started. The key cannot be removed.

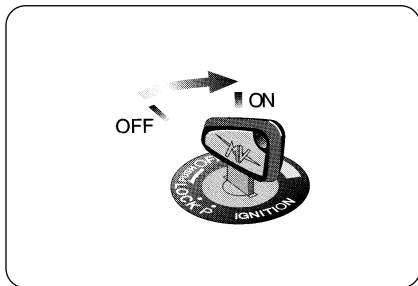
**CAUTION**

Do not leave the key on the ON position for a long time when the engine is not running, in order to avoid damage to the electrical parts of the motorcycle.



LOCK position

Turn the handlebar to the left or right. Press the key in gently while rotating it to the LOCK position. All electrical circuits are deactivated and the steering is locked. The key can be removed.

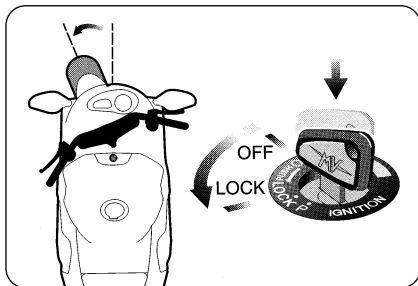

3 GB

P (PARKING) position

Turn the key from the LOCK position to the P position. All electrical circuits are deactivated except the parking lights. The steering is locked. The key can be removed.



CAUTION

Do not leave the key on the P position for a long time, in order to avoid discharging the battery of your motorcycle.

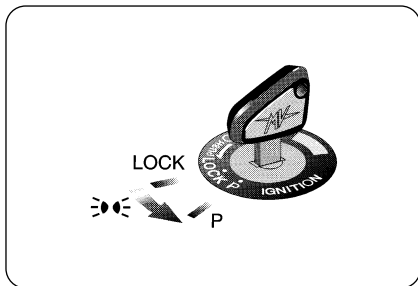



3.6. Gear lever

The **N** (neutral) position is indicated by the warning light on the instrument panel.

To change into first gear, push the lever down.

To change into second gear, lift the lever up. Lifting the lever up repeatedly engages all the other gears in succession up to the sixth speed.

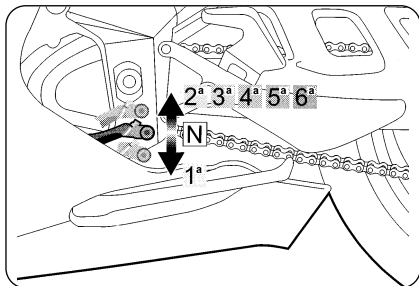



3.7. Instruments and warning lights

The instruments and warning lights are activated by turning the ignition switch to the ON position. After a preliminary check (approx. 7 seconds) the displayed information reflects the current general condition of the motorcycle.

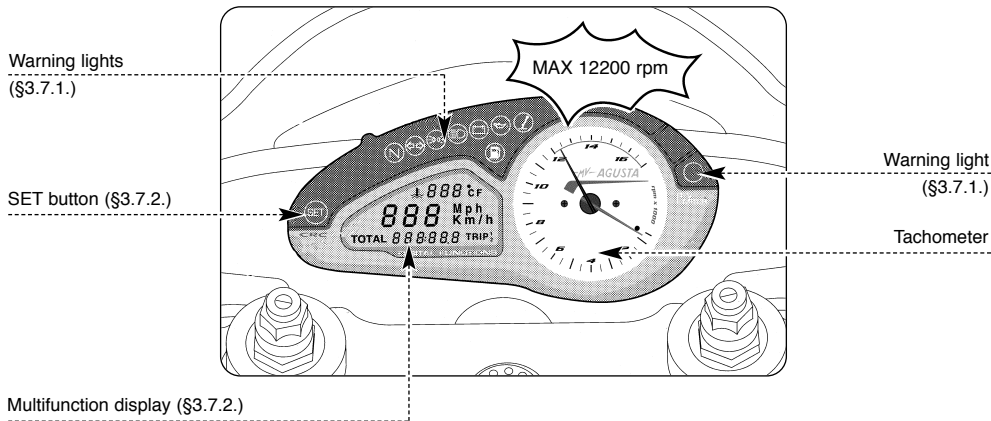



3.7.1. Warning lights

High beam warning light (blue)

Lights up when the high beam is activated.

Battery charge indicator (red)

Lights up when the alternator does not supply enough current to charge the battery.

Low beam warning light (green)

Comes on when the low beam is activated.

If the indicator comes on while riding, contact an authorized service centre.

Sidestand down warning light (red)

Lights up when the sidestand is down.

Neutral indicator (green)

Lights up when the gears are in neutral.

Rev limiter warning light (red)

Lights up when the engine speed exceeds 12,200 rpm. The rev limiter limits the rpm to 13,000.

Turn indicator light (green)

Lights up when the turn indicators are activated.

Engine oil pressure warning light (red)

Lights up when the oil pressure is insufficient.

Reserve fuel indicator (amber)

Comes on when approximately 4 litres of fuel are left.



WARNING: If the warning light comes on while riding, stop the motorcycle immediately. Check the oil level and if necessary have it restored by a MV Agusta authorized service centre (see §3.8.). If the warning light comes on even if the oil level is correct, do not resume riding and contact a MV Agusta authorized service centre.

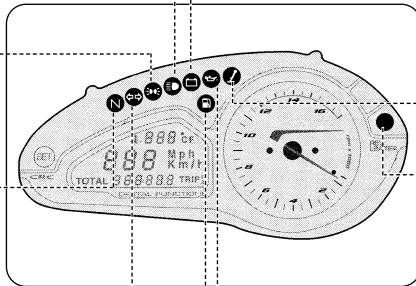



3.7.2. Multifunction display

Speedometer

Measures the speed of the vehicle. The speed can be displayed in kilometres per hour (km/h) or miles per hour (mph). The full-scale value is 350 km/h (218 mph).

SET button

Pressing the button allows the setting of the different display functions. Pressing the button again confirms the entered values.

Pressing the SET button while pressing the engine start button activates the chronometer function.

TOTAL mileage counter

Displays the total distance covered: from 0 to 99,999.9 (km or mi)

TRIP 1 mileage counter

Displays a first trip mileage count: from 0 to 9,999.9 (km or mi)

TRIP 2 mileage counter

Displays a second trip mileage count: from 0 to 9,999.9 (km or mi)

Clock

Displays the time (0÷24)

Thermometer

Displays the coolant temperature in degrees centigrade (°C) or Fahrenheit (°F).

The display range is 40° to 140° C (104° to 284° F):

- Below 40° C (104° F) no temperature is displayed but three blinking lines denote a very low temperature.

- Between 40° and 49° C (104° and 120° F) the temperature reading blinks to indicate a low temperature.

- Between 50° and 111° C (122° and 232° F) the temperature reading is fixed.

- Between 112° and 140° C (234° and 284° F) the temperature reading blinks to indicate a high temperature.

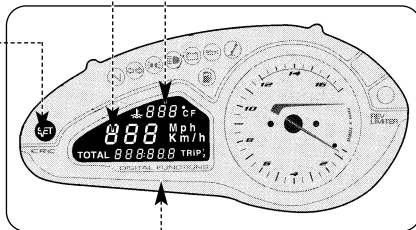

WARNING: If the temperature exceeds 120° C (248° F), stop the motorcycle immediately and check the coolant level. If the coolant level is low, have it topped up by a MV Agusta authorized service centre (see § 3.8.). If the high temperature indication is given even when the coolant level is correct, do not resume riding and contact a MV Agusta authorized service centre.



3.8. Table of lubricants and fluids

<i>Description</i>	<i>Recommended product</i>	<i>Specifications</i>
Engine lubrication oil	AGIP RACING 4T 10W/60 (*)	SAE 10W/60 - API SJ
Coolant	AGIP ECO - PERMANENT	Ethylene glycol diluted with 50 percent distilled water
Brake and clutch fluid	AGIP BRAKE FLUID DOT4	DOT4
Drive chain lubrication oil	MOTUL CHAIN LUBE ROAD	-

* : MV Agusta suggests to refer directly to its authorized dealers in order to purchase the recommended product. The AGIP Racing 4T 10W/60 engine oil has been expressly produced for the F4 motorcycle engine. If the above described lubricant is not available, MV Agusta suggests to use a fully synthetic engine oil having characteristics equal or better than the ones prescribed in the following standards:

- Consistent with: API SJ
- Consistent with: ACEA A3
- Consistent with: JASO MA
- SAE Rating: SAE 20 W-50 or 10 W-60

NOTE

The above standard denominations must be written, alone or together, on the engine oil container label.





4.1. Using the motorcycle

This section provides the basic information needed to correctly operate the motorcycle.



WARNING

Your motorcycle shows high power and performance characteristics; therefore, its use requires an adequate level of knowledge of the vehicle. When you use this motorcycle for the first time, it is essential to adopt a cautious attitude. An aggressive or reckless riding attitude can lead to accidents, compromising the driver's and other people's safety.



WARNING

THE RESTRICTIONS RELATED TO THE ALLOWED USE OF THE VEHICLE ARE DESCRIBED IN THE SECTION "SAFETY INFORMATIONS".



CAUTION

The high temperatures caused by the use of the vehicle on race circuits could compromise the efficiency of the catalytic converter and of the exhaust system; therefore, we suggest assembling a special exhaust system when using the vehicle on race circuits.



4.2 Running-in



CAUTION

Failure to observe the indications provided below can reduce performance and shorten the life of the motorcycle.

Running-in is generally considered to apply only to the engine. In fact, it should be regarded as an essential phase for other important parts such as the tyres, the brakes and the drive chain. During the very first miles, adopt a relaxed riding style.

□ 0 to 500 km (0 to 300 mi) (A)

Frequently change the engine speed. If possible, prefer hilly routes with gentle slopes and many bends. Avoid long straight stretches.

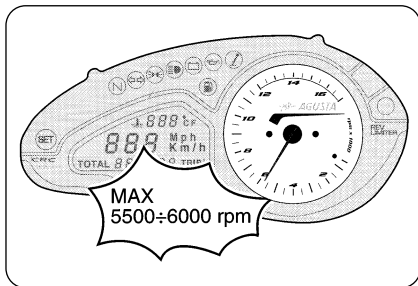

WARNING

New tyres must undergo a proper running-in period to reach their complete efficiency. Avoid abrupt acceleration, turning and braking during the first 100 km. Failure to observe these prescriptions can lead to the sliding of the wheels and the loss of control of the vehicle with subsequent risk of accidents.



❑ **500 to 1000 km (300 to 600 mi)**

Avoid lugging or overspeeding the engine, and vary your speed frequently.

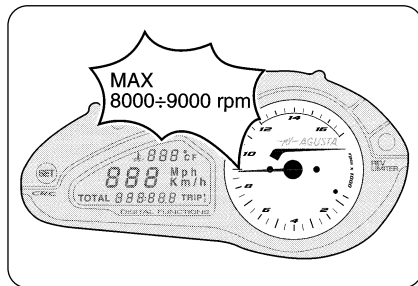

❑ **1000 to 2500 km (600 to 1600 mi)**

Higher engine performance can be demanded, but it is advisable not to exceed the engine speed shown in the figure.

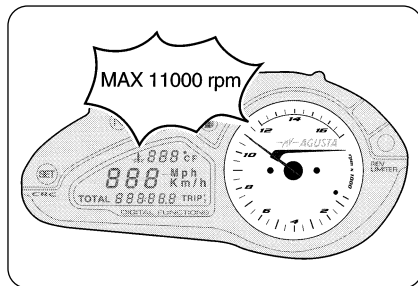



4.3. Starting the engine



WARNING

Starting the engine in a closed place can be dangerous. Exhaust emissions contain carbon monoxide, a colourless and odourless gas that can lead to serious harm or even death when inhaled.

Only start the engine outdoor, in the open air.

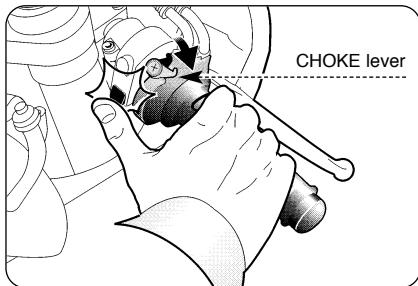

CB 4

▶ As you turn the ignition switch to the ON position, the instruments and the warning lights will go through the self-diagnostic cycle; during this phase, make sure that all the warning lights on the dashboard come on. One of the following conditions must be verified, in order that the ignition switch system allows engine starting:

- The gears are in neutral.
- The gears are engaged, the clutch lever is pulled and the side stand is up.

Cold starting

▶ Rotate the CHOKE lever without turning the throttle twist grip and then press the start button.



► As soon as the engine starts, release the button and, after warming up the engine for a short time, return the CHOKE lever to its original position.

❑ **Hot starting**

- Press the start button without turning the throttle twist grip.
- As soon as the engine starts, release the button.



CAUTION

- Do not press the start button for longer than 5 consecutive seconds.
- Avoid warming up the engine while the vehicle is stationary. The subsequent engine overheating can cause damage to the internal parts of the engine. It is advisable to bring the engine to the working temperature by riding at reduced speed.
- To ensure the maximum life of the engine, never speed up at full throttle when the engine is cold.

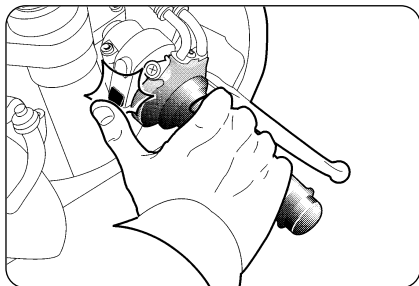



4.4. Selecting and setting the display functions

The multifunction display allows to change some of the main measuring parameters and to activate the chronometer function.

The main possible operations are the following:

- Selection of the display functions:
 - TOTAL Mileage Counter
 - TRIP 1 Mileage Counter
 - TRIP 2 Mileage Counter
 - Clock
 - Chronometer
- Setting the unit of the following quantities:
 - Speed
 - Mileage
 - Engine Oil Temperature
- Resetting the trip mileage counters:
 - TRIP 1 Mileage Counter
 - TRIP 2 Mileage Counter
- Setting the clock
- Activation of the chronometer function

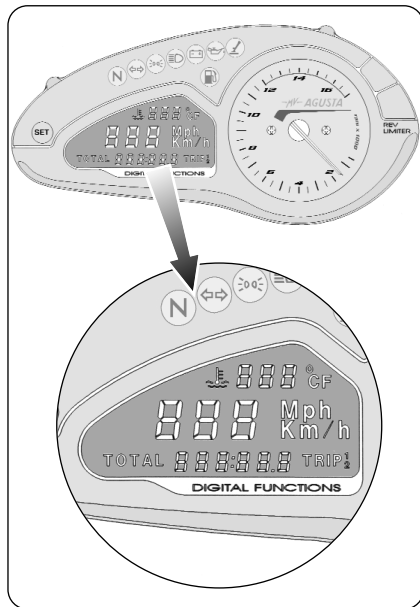



4.4.1. Selecting the display functions

You can select the following functions:

- TOTAL Mileage Counter
- TRIP 1 Mileage Counter
- TRIP 2 Mileage Counter
- Clock
- Chronometer

► The TOTAL, TRIP 1 and TRIP 2 functions can be displayed by pressing the engine start button. Pressing the button repeatedly cycles through the different functions. Select the desired function.

► The displaying of the chronometer function is shown in the following page.

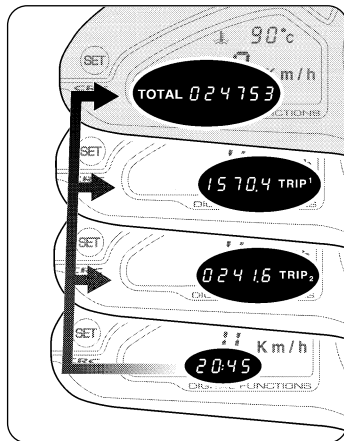
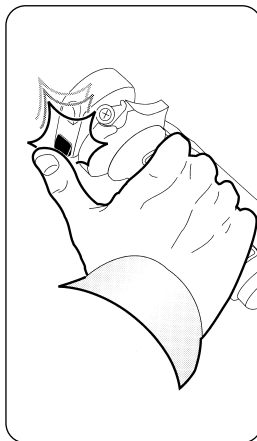

4 GB



WARNING

The operation must be performed while the engine is running, the gears are in neutral, the motorcycle is stationary, and with the feet on the ground. Do not set the display functions while riding as it may cause loss of control of the vehicle.



❑ Chronometer

► The chronometer function can be activated only when one of the following functions is selected:

- TOTAL Mileage Counter
- TRIP 1 Mileage Counter
- TRIP 2 Mileage Counter
- Clock

► Press the SET button and the engine start button at the same time for longer than 2 seconds.

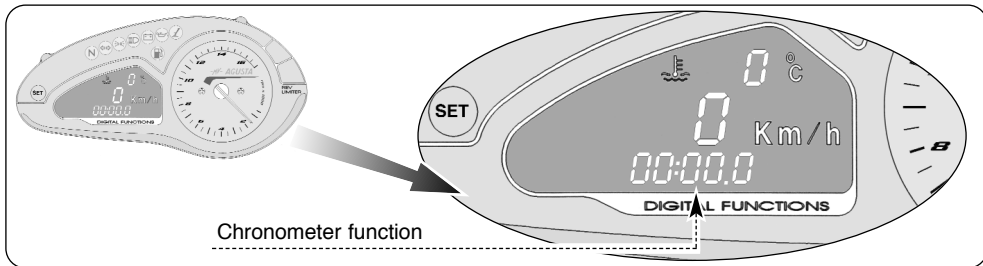
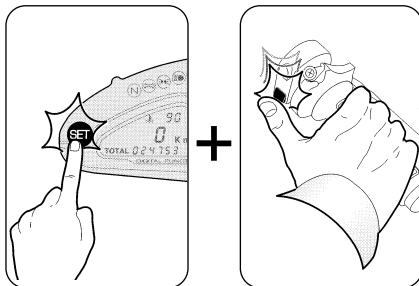

The chronometer function is explained in the following paragraphs (see § 4.4.5).



4.4.2. Setting the measurement units

It is possible to set the measurement units of the displayed quantities.



WARNING

The operation must be performed while the engine is running, the gears are in neutral, the motorcycle is stationary, and with the feet on the ground. Do not set the display functions while riding as it may cause loss of control of the vehicle.

□ Speedometer (Km/h - Mph)

- ▶ Repeatedly press the engine start button until the TOTAL mileage counter is displayed.
- ▶ Press the SET button; the speedometer unit starts blinking.

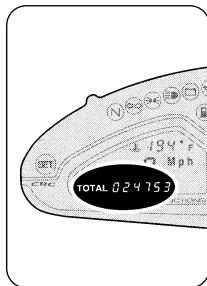
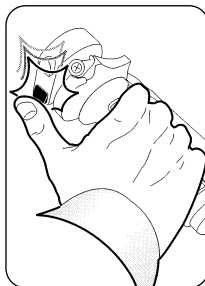

4 GB

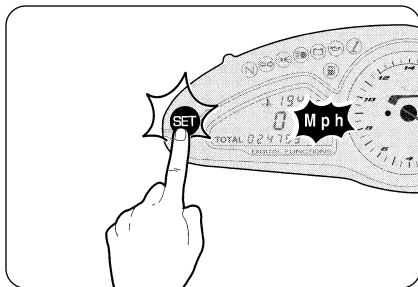



► Press the engine start button to toggle between Km/h and Mph. Changing the speedometer unit also changes the units for the total and trip mileage counters.

Remember that: 1 mi = 1,609 Km

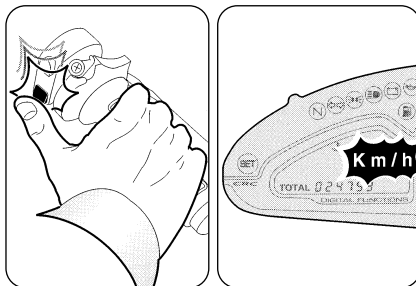

► Press the SET button to confirm the speedometer unit. The thermometer unit will start blinking, indicating that the display is ready for the next setting.

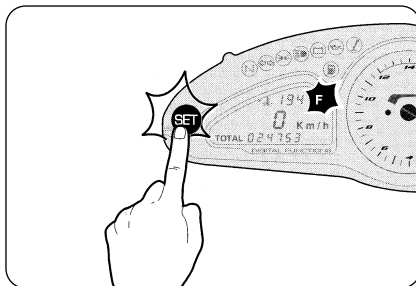

CB 4



❑ Thermometer (° C - ° F)

- ▶ Press the engine start button to toggle between ° C and ° F.

Remember that: $T (^{\circ}\text{F}) = 1.8 \cdot t (^{\circ}\text{C}) + 32$

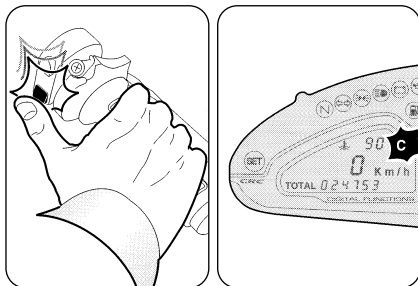

- ▶ Press SET to confirm the temperature unit.

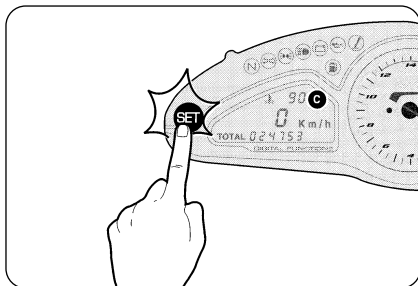



4.4.3. Resetting the trip mileage counters

The TRIP 1 and TRIP 2 counters can be reset as follows:



WARNING

The operation must be performed while the engine is running, the gears are in neutral, the motorcycle is stationary, and with the feet on the ground. Do not set the display functions while riding as it may cause loss of control of the vehicle.

▶ Select the TRIP 1 function by pressing the engine start button.

▶ Press the button for longer than four seconds. The TRIP 1 mileage will start blinking.

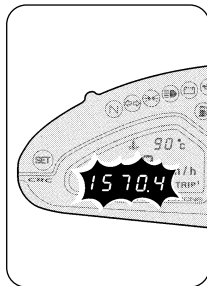
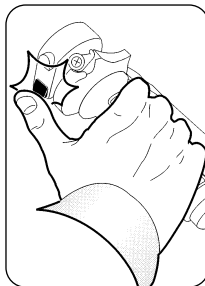
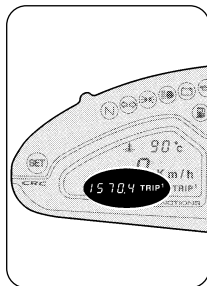
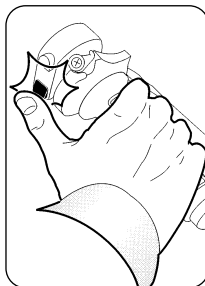



► Pressing the button for less than four seconds sets the mileage to zero. If, on the other hand, the button is pressed for longer than four seconds the entire resetting procedure is cancelled.

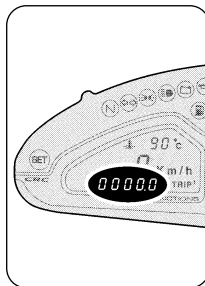
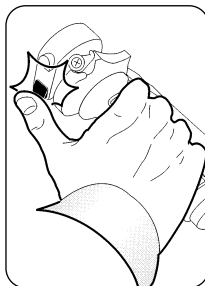

► Select the TRIP 2 function by pressing the engine start button.

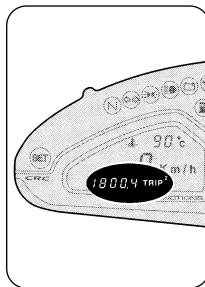
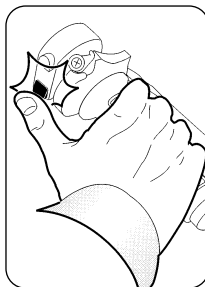

4 GB



► Press the engine start button for longer than four seconds; the TRIP 2 mileage will start blinking.

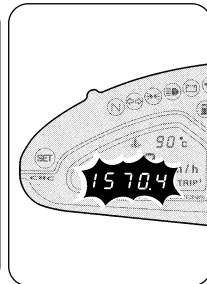
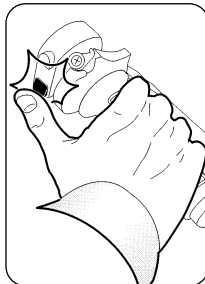

► Pressing the button for less than four seconds sets the mileage to zero. If, on the other hand, the button is pressed for longer than four seconds the entire resetting procedure is cancelled.

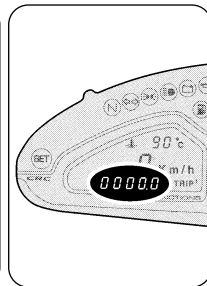
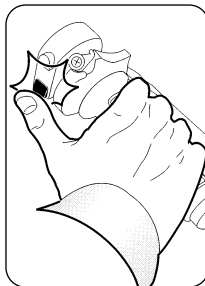



4.4.4. Setting the clock

It is possible to set the clock function.



WARNING

The operation must be performed while the engine is running, the gears are in neutral, the motorcycle is stationary, and with the feet on the ground. Do not set the display functions while riding as it may cause loss of control of the vehicle.

- ▶ Repeatedly press the engine start button until the time is displayed.
- ▶ Press the SET button – the first hour digit will start blinking.

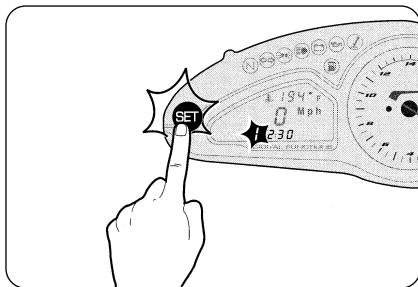
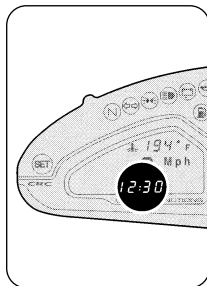
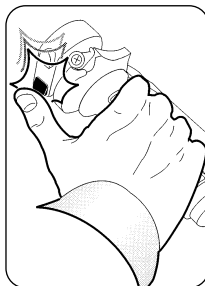



- ▶ Hold down the engine start button and release it as soon as the desired figure is displayed.

NOTE

To quickly cycle through the selected digit, hold the start button depressed for longer than two seconds.

- ▶ Press SET to confirm the first hour digit and to be able to set the following digit.

- ▶ Repeat the procedure to set the second hour digit and the first and second minute digits.

- ▶ Press SET to confirm the time and exit the set (blinking) mode.

NOTE

The instrument panel has an integrated memory which retains all the parameters even when the engine is not running. Except for the clock, which is reset, all the parameters are retained even when the battery is disconnected.

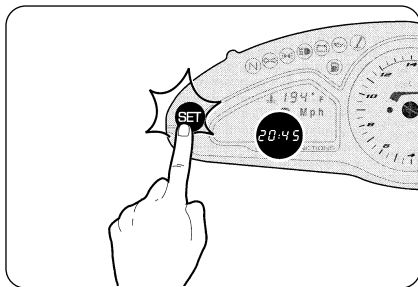
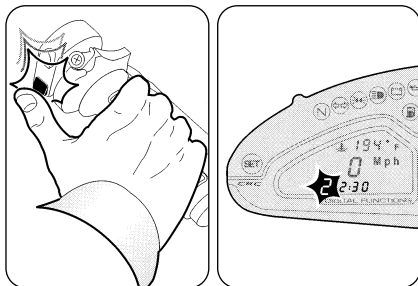



4.4.5. Chronometer

► The chronometer function can be activated only when one of the following functions is displayed:

- TOTAL Mileage Counter
- TRIP 1 Mileage Counter
- TRIP 2 Mileage Counter
- Clock

► Press the SET button and the engine start button at the same time for longer than 2 seconds. The chronometer function is activated. The digits “00:00.0” are displayed.



WARNING

The operation must be performed while the engine is running, the gears are in neutral, the motorcycle is stationary, and with the feet on the ground. Do not set the display functions while riding as it may cause loss of control of the vehicle.

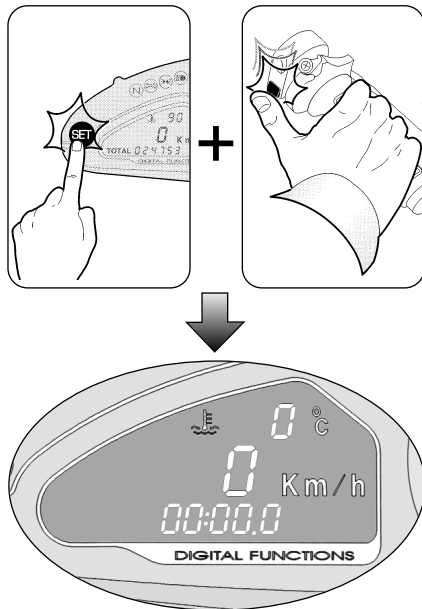



□ Lap Time Recording

After the chronometer function has been activated, it is possible to begin the data storing by pressing the high beam flasher button. Performing this operation starts the first lap time measurement.

The two points between the minutes and seconds digits will start blinking. The instrument will start measuring the first lap time.

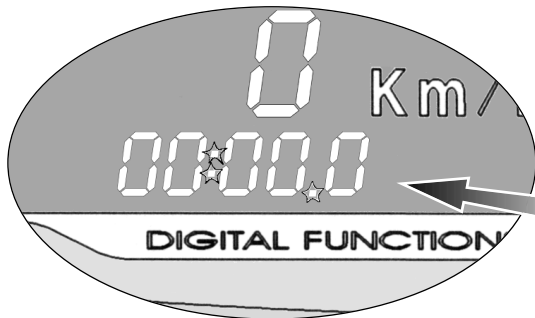
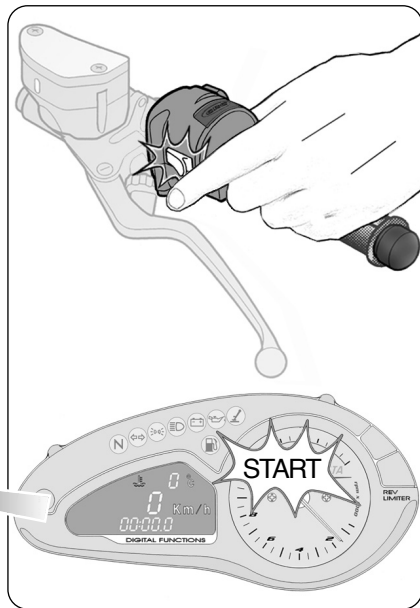



The first lap time is recorded by pressing the high beam flasher button again. At the same time, the instrument will start measuring the second lap time.

The first lap time is stored in the instrument memory, and it remains displayed until the next lap time is recorded.

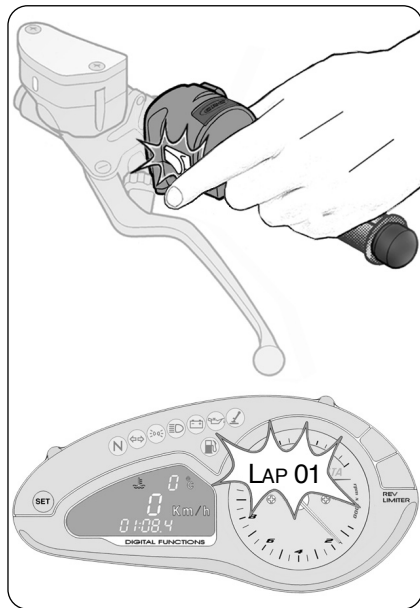



Repeating the above mentioned operations, you record one lap time every time you press the high beam button. The instrument can perform up to 80 consecutive recordings.

If the present lap time is lower than the previous one, the symbol “ - ” is displayed near the chronometer digits.

CB 4

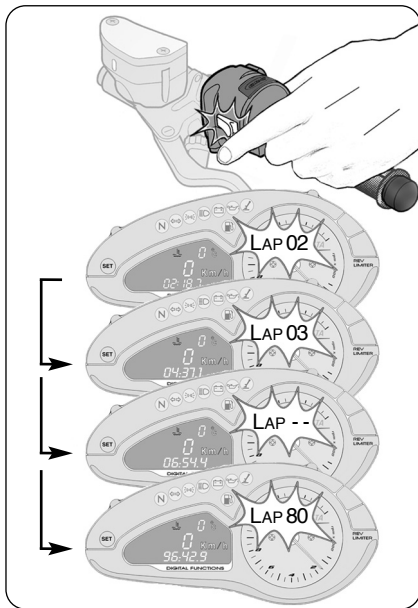
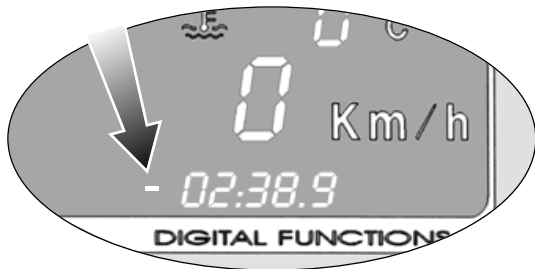



□ Lap Time Displaying

At the end of the lap time recording, it is possible to display the stored data.

NOTE

Make sure not to shut off the engine. This would cause the loss of all the stored data.

- ▶ Press the SET button for a time longer than 0.25 sec and less than 2 sec.

NOTE

Pressing the SET button for longer than 2 seconds would cause the loss of all the stored data.

- ▶ The “LAP 01” writing is displayed; after one second, the display shows the time corresponding to the first recorded lap.

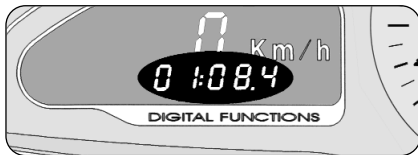
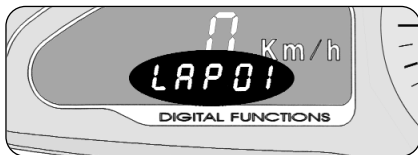
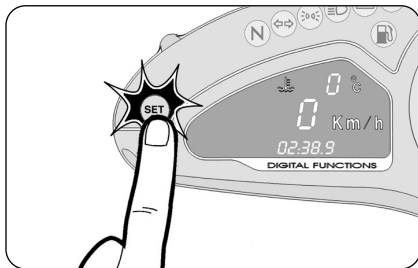



► The writing “LAP 02” is displayed by pressing the high beam flasher button; after one second, the display shows the time corresponding to the second recorded lap.

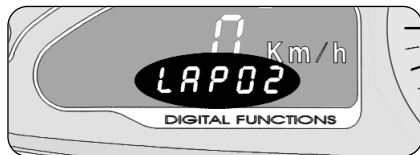
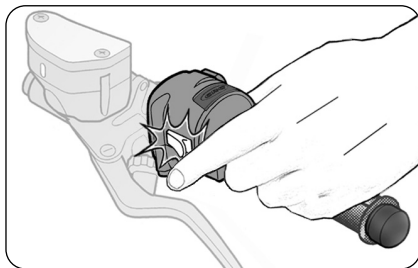

► Repeatedly pressing the high beam flasher button, the following lap times are displayed. After the last lap time has been displayed, the display shows the first lap data (“LAP 01”) by pressing the high beam button once more.

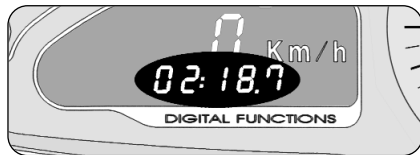



□ Fastest Lap Time Displaying

- ▶ Make sure that the display is on the lap time displaying mode, and that the first lap data are displayed ("LAP 01").
- ▶ Press the SET button for longer than 2 seconds.

NOTE

Pressing the SET button for less than 2 seconds would cause the exit from the lap time displaying mode.

- ▶ The number of the fastest lap is displayed; after one second, the display shows the corresponding fastest lap time.

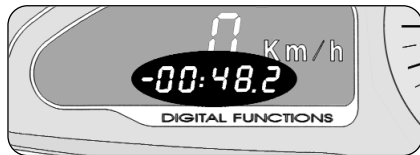
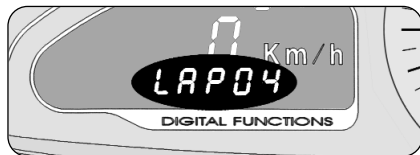
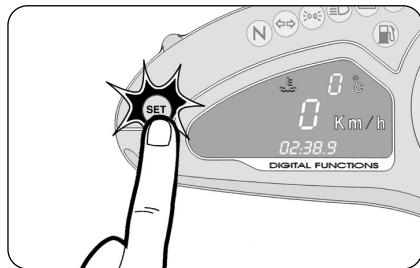



□ Return to the Lap Time Recording mode

▶ Pressing the SET button for longer than 0.25 sec and less than 2 sec, the display returns to the lap time recording mode. By now, you can continue your previous timing session or begin a new one.

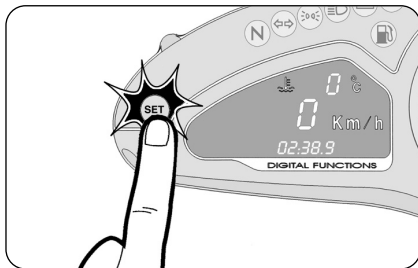

▶ The display shows the time corresponding to the last stored lap.

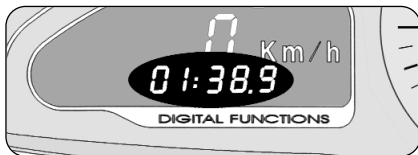

NOTE

When you return to the lap time recording mode, the digits “00:00.0” will be displayed if no lap time has been previously stored.

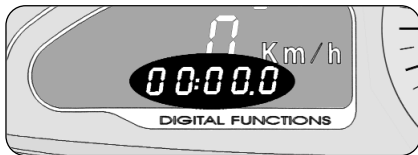



❑ Resetting the chronometer

You can reset the chronometer by pressing the SET button for longer than 2 seconds. This operation will cancel all the previously stored data from the instrument memory.

NOTE

Once you cancel the previously stored data, they cannot be retrieved.

Chronometer resetting can also be performed when the chronometer function is active. In this case, the timing session will be stopped.

After resetting the chronometer, the digits “00:00.0” will be displayed.

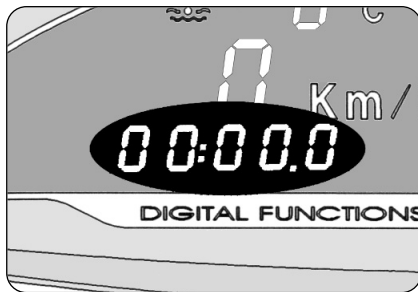
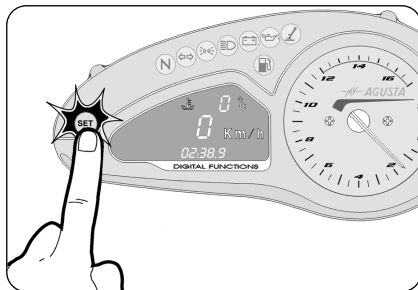



4.5. Refuelling

**WARNING**

Petrol and its fumes are highly toxic and flammable. Avoid contact and inhalation. When refuelling, switch off the engine, avoid smoking, and keep away from flames, sparks and heat sources. Perform refuelling in the open air or in a well ventilated area.

**CAUTION**

Only use unleaded fuel with a R.O.N. octane rating of 95 or higher. The green dot on the lower side of the tank cap serves as a reminder of this.

- ▶ Lift the dust cover.
- ▶ Insert the key into the lock, rotate it clockwise and lift the tank cap.
- ▶ After refuelling, press down the tank cap while rotating the key clockwise to facilitate the locking. Then release the key and remove it.

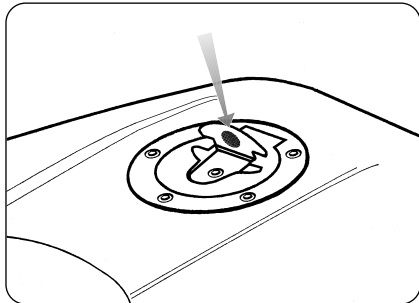
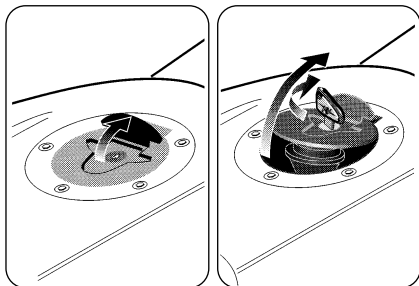

**WARNING**

Overfilling the tank may cause the fuel to overflow as a result of the expansion due to the heat from the engine or to exposure to sunlight. Fuel spills can catch fire. The level of the fuel in the tank must never be higher than the base of the filler.

**CAUTION**

Immediately wipe the overflowed fuel with a clean cloth, to avoid damage to the painted or plastic surfaces.

**WARNING**

Verify that the tank filler cap is correctly closed before using the motorcycle.

4 GB

4.6. Glove compartment

- ▶ Insert the key into the lock.
- ▶ Press the rearmost portion of the tail section down while turning the key clockwise.
- ▶ Gently lift the tail section while gently pulling backwards. Fold the tail section up over the fuel tank.

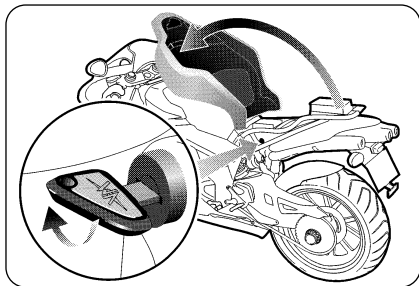



4.7. Parking the motorcycle

□ Using the sidestand



CAUTION

- Park the motorcycle safely on solid ground.
- On slopes, engage the first gear and park the vehicle so that the front wheel faces uphill. Remember to put the gear lever in the neutral position before restarting the engine.
- Never leave the vehicle unattended while the engine key is in the dashboard.

► Using your foot, lower the sidestand as far as it will go, and then slowly tip the motorcycle toward you to bring the stand supporting foot into contact with the ground's surface.

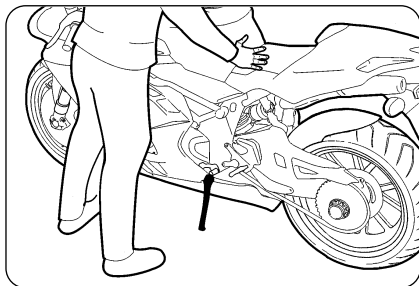

**WARNING**

Do not sit on the vehicle when it is parked on the sidestand, as your full weight would rest on the vehicle's only support.

**WARNING**

Before riding off, ensure that the sidestand warning light on the instrument panel goes out. In any case, make sure that the stand has been retracted.

If you notice a malfunction of the side stand switch, have it controlled by your MV Agusta dealer before using the motorcycle.

□ Using the rear stand

Insert the stand pin into the rear wheel axle hole on the left side of the motorcycle. Rest the stand on the ground and, pressing down on the stand, lift the vehicle until it reaches a stable condition.

**CAUTION**

This operation is best carried out with two people, one to steady the motorcycle and one to manipulate the rear stand.

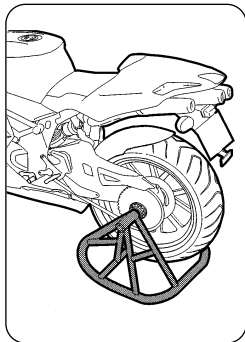
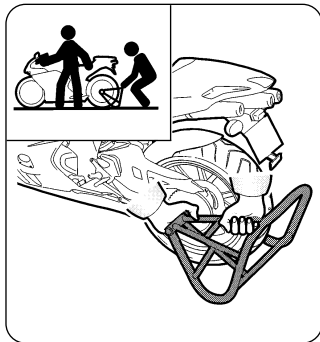



5.1. List of adjustments

There are many adjustments that can significantly improve the ergonomics, geometry and safety of the motorcycle.

However, since an incorrect adjustment of particularly important components can lead to dangerous situations, some of the above adjustments must be performed only by authorized MV Agusta Service Centers.

**WARNING**

All adjustments must be performed when the vehicle is stationary.



(F) Rearview mirror adjustment (§5.5.)

(A) Clutch lever adjustment (§5.4.)

(F) Rearview mirror adjustment (§5.5.)

(C) Right-hand footrest adjustment (§5.2.)

(E) Rear brake lever adjustment (§5.2.)

(B) Front brake lever adjustment (§5.3.)

(G) Steering damper adjustment (§5.6.)

(D) Gear lever adjustment (§5.2.)

(L) Rear suspension adjustment (§5.8.)

(N) Headlight adjustment (§5.2.)

(M) Drive chain adjustment (§5.2.)

(C) Left-hand footrest adjustment (§5.2.)

(H) Front suspension adjustment (§5.7.)

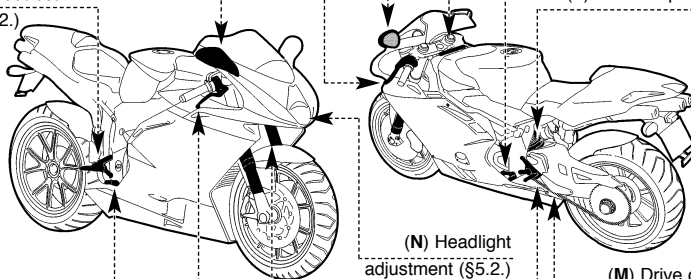



5.2. Table of adjustments



A - Clutch lever adjustment: Optimizes the grip to suit the rider's needs (§5.4).



B - Front brake lever adjustment: Optimizes the grip to suit the rider's needs (§5.3).



C - LH and RH footrest adjustment: Optimizes the position of the footrests to suit the rider's needs.



D - Gear lever adjustment: Optimizes the position of the lever to suit the rider's needs.



E - Rear brake lever adjustment: Optimizes the position of the lever to suit the rider's needs.



F - Rearview mirror adjustment: Optimizes the orientation of the rearview mirrors (§ 5.5).



G - Steering damper adjustment: Adjusts the steering stiffness to the rider's preference (§5.6).



H - Front suspension adjustment: The following can be adjusted to adapt the response of the suspension to the rider's preference:

- spring preload (§ 5.7.1.)
- rebound damper (§ 5.7.2.)
- compression damper (§ 5.7.3.)



L - Rear suspension adjustment: The following can be adjusted to adapt the response of the suspension to the rider's preference:



- geometry height
- spring preload (§ 5.8.1.)
- rebound damper (§ 5.8.2.)
- high speed compression damper (§ 5.8.3.)
- low speed compression damper (§ 5.8.4.)



M - Drive chain adjustment: To ensure safe and effective transmission of power.



N - Headlight adjustment: To adjust the range of the light beam to the geometry of the motorcycle (§5.9).



5.3. Adjusting the front brake lever

While pulling the lever to counter the action of the spring, turn the ring clockwise or counterclockwise to move the lever away or towards the hand-grip respectively.

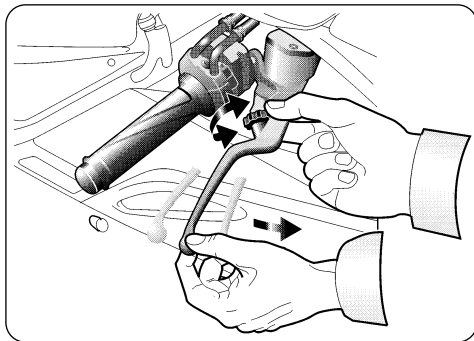

5.4. Adjusting the clutch lever

While pulling the lever to counter the action of the spring, turn the ring clockwise or counterclockwise to move the lever away or towards the hand-grip respectively.

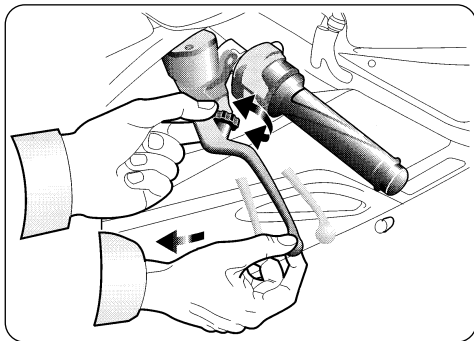



5.5. Adjusting the rearview mirrors

Press the mirror at the points shown in the figure to adjust its position in the four directions.

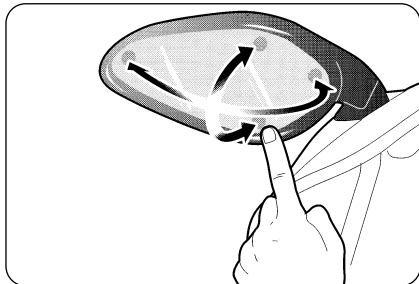

5.6. Adjusting the steering damper

The standard adjustment is obtained by fully rotating the knob counterclockwise. In this position the damper offers the least resistance to the rotation of the steering. To suit the rider's needs, the action of the damper can be gradually increased by rotating the knob clockwise.

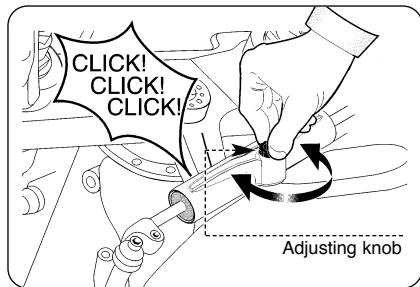



5.7. Adjusting the front suspension



WARNING

It is essential that the adjusters of both fork rods are adjusted to the same position.

NOTE

The adjustment of the suspensions must be preferably performed with the fuel tank full.

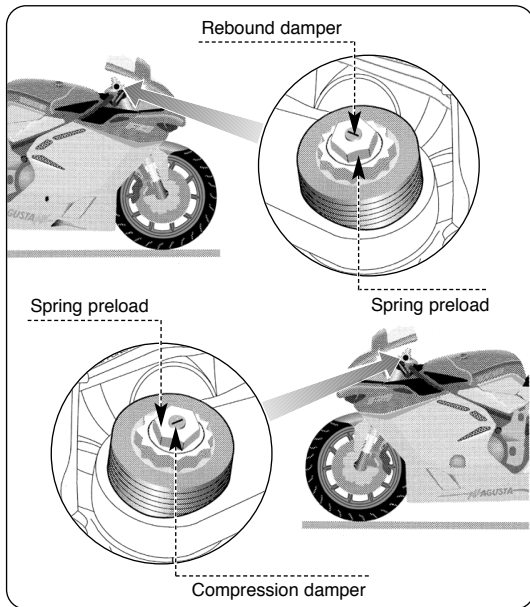



5.7.1. Spring preload (front suspension)

The adjustment is obtained from the standard position, which is found by fully turning the adjusting nut counterclockwise and then clockwise (see enclosed table). Rotate clockwise to increase the spring preload or counterclockwise to decrease it.

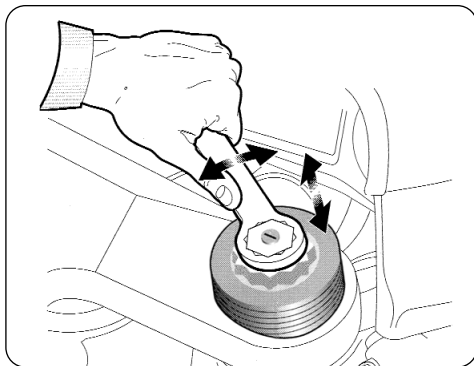

5.7.2. Rebound damper (front suspension)

The adjustment is obtained from the standard position, which is found by fully turning the screw clockwise and then counterclockwise (see table). Rotate clockwise to increase the damping action or counterclockwise to decrease it.

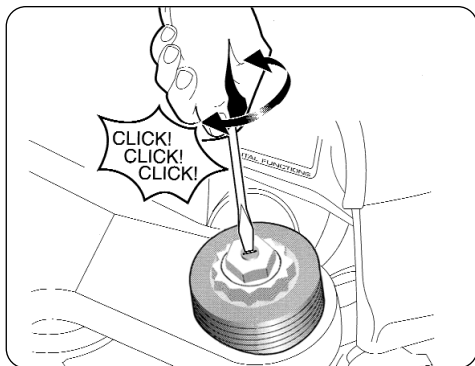



5.7.3. Compression damper (front suspension)

The adjustment is obtained from the standard position, which is found by fully turning the screw clockwise and then counterclockwise (see table). Rotate clockwise to increase the damping action or counterclockwise to decrease it.

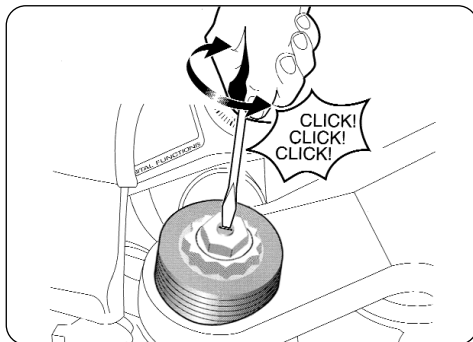



5.8. Adjusting the rear suspension



WARNING: The high temperature of the exhaust pipes can cause burns. Before adjusting the rear suspension, shut off the engine and wait until the exhaust pipes have thoroughly cooled.



WARNING: The rear shock absorber contains highly compressed gas. Do not try to open or disassemble it in any way.



CAUTION: When you estimate the rear suspension settings, never push or pull in any way on the exhaust mufflers. They would be certainly damaged.

NOTE: At the moment of delivery of the motorcycle, the rear suspension is adjusted in the standard configuration (see enclosed table).

NOTE: The adjustment of the suspensions must be preferably performed with the fuel tank full.

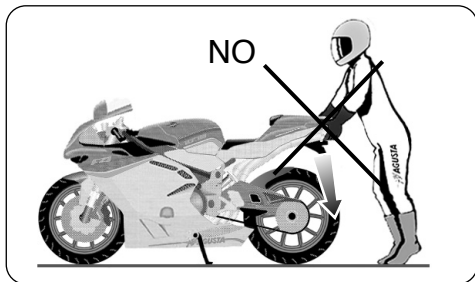
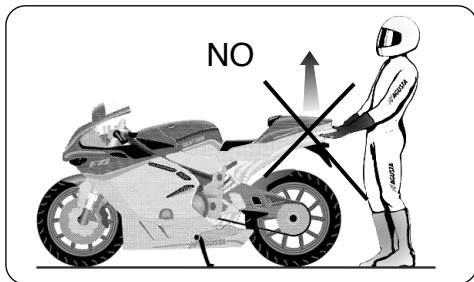

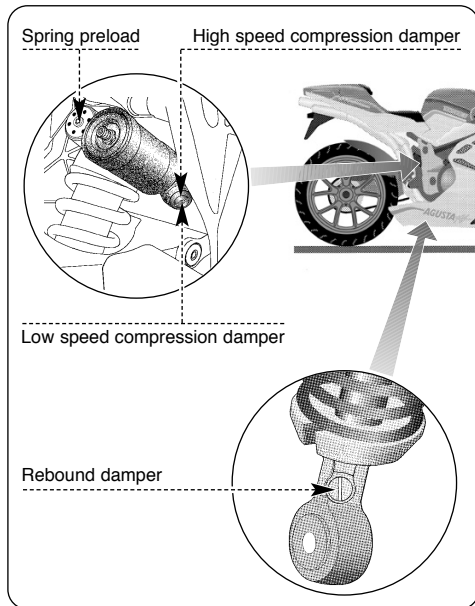

5.8.1. Spring preload (rear suspension)

The adjustment is obtained from the standard position, which is found by fully rotating the screw counterclockwise and then clockwise (see attached table). Rotate clockwise to increase the spring preload or counterclockwise to decrease it.



CAUTION: Do not rotate the screw past its fully clockwise or counterclockwise position, in order to avoid the damage of the hydraulic device.

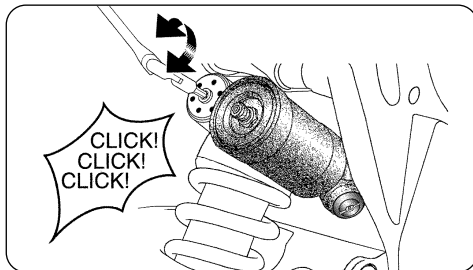



5.8.2. Rebound damper (rear suspension)

The adjustment is obtained from the standard position, which is found by fully rotating the ring clockwise and then counterclockwise (see table). Rotate clockwise to increase the damping action or counterclockwise to decrease it.

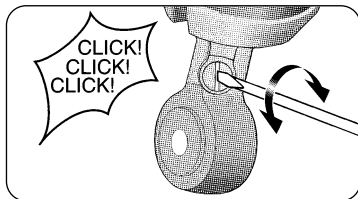

5.8.3. High speed compression damper (rear suspension)

The adjustment is obtained from the standard position, which is found by fully rotating the screw counterclockwise and then clockwise (see table). Rotate clockwise to increase the damping action or counterclockwise to decrease it.



5.8.4. Low speed compression damper (rear suspension)

The adjustment is obtained from the standard position, which is found by fully rotating the screw clockwise and then counterclockwise (see table). Rotate clockwise to increase the damping action or counterclockwise to decrease it.

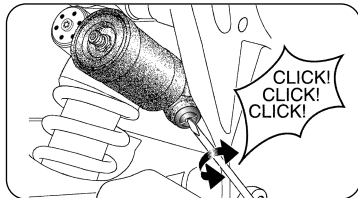



5.9. Headlight adjustment

Place the vehicle at a distance of 10 m from a vertical wall.

Make sure that the motorcycle is placed on an even horizontal surface, and that the headlight's optical axis is perpendicular to the wall.

The vehicle must be held in an upright position. Measure the "X" distance between the headlight center and the ground surface, then trace a small cross on the wall at the same height.

When you turn the headlight on, the upper boundary line between the dark area and the lighted area must be at a height equal or lower than the 9/10 of the headlight center height (X).

For the adjustment of the headlight, the possible adjustment range is : $\pm 4^\circ$.

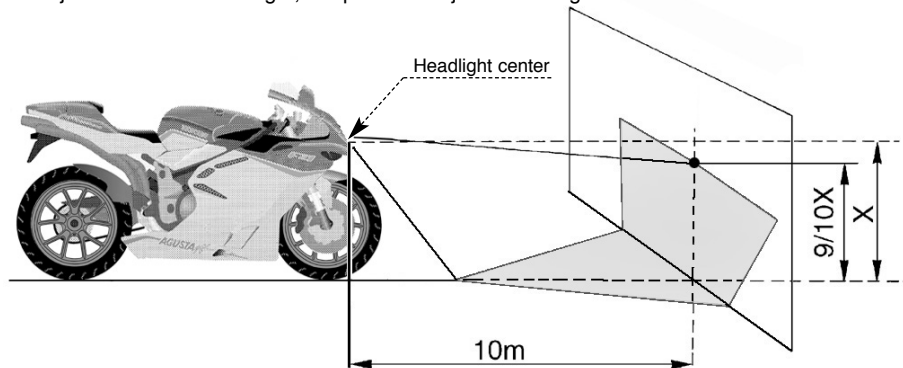



Information

MV Agusta S.p.A. is committed to a policy of constant improvement; therefore, you may find slight differences between the information provided in this document and the vehicle you purchased. MV Agusta motorcycles are exported in several countries, in which different rules and regulations (concerning both the Highway Code and the homologation procedures) are in force. Relying on your understanding, MV Agusta S.p.A. deems it necessary to reserve the right to change its products and the related documentation at any time and without notice.

We suggest to often visit the Internet site **www.mvagusta.it** in order to obtain informations and updates about the MV Agusta products and the related documentation.



Respect and defend natural environment

Everything we do affects the whole planet as well as its resources.

MV Agusta, in order to protect the interests of the community, awakens the Customers and the Technical Assistance operators to use the vehicle and dispose of its replaced parts respecting the laws in force concerning environmental pollution and waste disposal and recycling.

© 2007

This document may not, in whole or in part, be reproduced without prior consent, in writing, from MV Agusta S.p.A.

Part No. 8000B1113

Edition No. 1 - November 2007

MV AGUSTA



Manuel d'utilisation
Version Française

BIERA

Cher client,

Nous vous remercions de la confiance que vous nous accordez et vous félicitons pour votre nouvelle F4 312.

Votre choix récompense l'application et l'effort passionné de nos techniciens pour donner à la F4 312 des caractéristiques fonctionnelles et esthétiques qui la placent au dessus des motos de plus haut niveau actuellement disponibles sur le marché et font d'elle un objet convoité et exclusif.

Si d'un point de vue purement technique, la F4 312 représente avec ses nombreuses innovations, une référence au niveau mondial, sa ligne hors du temps douce et fuselée est une magnifique fusion entre un passé glorieux et un nouveau millénaire.

Le mariage de ces éléments, que seuls la recherche du détail, la passion et le désir de réaliser une moto techniquement et esthétiquement supérieure, ont permis d'atteindre, élève la F4 312 au dessus de toutes les modes passagères et lui confère le privilège d'être considérée comme un objet unique au monde.

Si vous désirez plus d'information, n'hésitez pas à contacter notre Service Après-Vente MV Agusta.

Bon divertissement

*Claudio Castiglioni
Président
MV Agusta*



TABLE DES MATIÈRES

<i>Chap.</i>	<i>Sujets abordés</i>	<i>page</i>	<i>Chap.</i>	<i>Sujets abordés</i>	<i>page</i>
1	GÉNÉRALITÉS	5	4	UTILISATION	27
1.1.	Utilité de ce livret	5	4.1.	Utilisation de la moto	27
1.2.	Symboles	6	4.2.	Rodage	28
1.3.	Contenu du CD-Rom	7	4.3.	Démarrage	30
1.4.	Données d'identification	8	4.4.	Sélection et modification des fonctions d'affichage	32
2	INFORMATIONS SUR LA SÉCURITÉ	10	4.4.1.	Sélection des fonctions d'affichage	33
2.1.	Utilisation admise du véhicule	10	4.4.2.	Réglage de l'unité de mesure	35
2.2.	Entretien	10	4.4.3.	Mise à zéro des compteurs kilométriques partiels	38
2.3.	Accessoires et modifications	11	4.4.4.	Réglage de la fonction horloge	41
2.4.	Chargement du véhicule	11	4.4.5.	Chronomètre	43
3	COMMANDES ET APPAREILS	13	4.5.	Approvisionnement en carburant	52
3.1.	Position des commandes et appareils	13	4.6.	Accès à la boîte à gants	53
3.2.	Béquille latérale	14	4.7.	Stationnement de la moto	54
3.3.	Commandes au guidon gauche	15	5	RÉGLAGES	56
3.4.	Commandes au guidon droit	17	5.1.	Liste des réglages	56
3.5.	Contacteur principal et verrouillage de direction	20	5.2.	Tableau des réglages	58
3.6.	Sélecteur de vitesses	22	5.3.	Réglage du levier de frein avant	59
3.7.	Appareils et voyants	23	5.4.	Réglage du levier d'embrayage	59
3.7.1.	Voyants lumineux	24	5.5.	Réglage des rétroviseurs	59
3.7.2.	Affichage multifonctions	25	5.6.	Réglage de l'amortisseur de direction	60
3.8.	Tableau des lubrifiants et liquides	26			



TABLE DES MATIÈRES

<i>Chap.</i>	<i>Sujets abordés</i>	<i>page</i>
5.7.	Réglage de la suspension avant	61
5.7.1.	Précharge du ressort (suspension avant)	62
5.7.2.	Dispositif hydraulique de freinage en détente (suspension avant)	62
5.7.3.	Dispositif hydraulique de freinage en compression (suspension avant)	63
5.8.	Réglage de la suspension arrière	64
5.8.1.	Précharge du ressort (suspension arrière)	65
5.8.2.	Dispositif hydraulique de freinage en détente (suspension arrière)	66
5.8.3.	Dispositif hydraulique de freinage en compression pour vitesse élevée (suspension arrière)	66
5.8.4.	Dispositif hydraulique de freinage en compression pour vitesse basse (suspension arrière)	66
5.9.	Réglage du projecteur avant	67



1.1. Utilité de ce livret

Le présent Manuel fournit les informations nécessaires pour une utilisation correcte et sûre de la moto.

Est également fourni un Manuel Rapide de poche contenant les informations essentielles pour l'utilisation du véhicule.

Le Manuel est fourni aussi sous format électronique (.pdf) sur le présent CD-ROM et peut être imprimé ou affiché sur tout PC avec système Windows ou Mac.

Nous vous recommandons de lire attentivement le Manuel avant d'utiliser la moto et de vous assurer que toutes les personnes utilisant la moto ont lu attentivement le Manuel.

Nous vous conseillons de toujours avoir sur vous le Manuel Rapide avec vos données d'identification et celles de la moto.



Copyright
MV AGUSTA Motor Spa
Tous droits réservés



1.2. Symboles

Les parties du texte particulièrement importantes qui concernent la sécurité de la personne et l'intégrité de la moto, sont mises en évidences par les pictogrammes suivants:



Danger - Attention: le non respect partiel ou total de ces prescriptions peut être source de danger pour soi-même et pour autrui.



Prudence - Précautions: le non respect partiel ou total de ces prescriptions peut être cause de dommages pour la moto.

Pour indiquer les personnes autorisées à exécuter les opérations de réglage et/ou d'entretien, celles-ci sont mises en évidences par les pictogrammes suivants:



Informations sur les opérations permises au motard.



Informations sur les opérations qui doivent être effectuées uniquement par le personnel autorisé.

Pour mettre en évidence les informations supplémentaires, les symboles suivants sont utilisés:



Le symbole  indique la nécessité d'utiliser un outil ou un appareil spécial pour l'exécution correcte de l'opération décrite.



Le symbole “§” renvoie au chapitre correspondant au numéro qui l'accompagne.



1.3. Contenu du CD-Rom

Le CD-ROM fourni contient en sus du présent Manuel le Manuel d'Entretien, le Manuel Rapide (est également fournie une version imprimée), le Guide des Concessionnaires et le Livret de Garantie.

Au moment de vous remettre la moto, votre Concessionnaire vous a remis le Certificat de Garantie et de Préparation à la route.

Nous vous invitons à conserver le Certificat avec les documents de la moto et les coupons qui vous seront remis à toutes les opérations de révision prévues par la garantie.

IMPORTANT

La copie du Certificat de Garantie et de Préparation à la route destinée à MV Agusta doit être remplie par le Concessionnaire et retournée à l'usine dans un délai de 10 jours après la date d'immatriculation.

Les copies des coupons de révision doivent toujours être remplies par le concessionnaire et retournées à MV Agusta dans un délai de 10 jours après la date d'exécution des interventions.



2) numéro de série du moteur

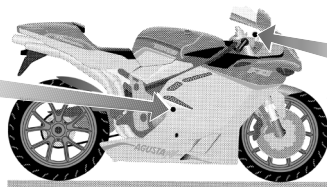
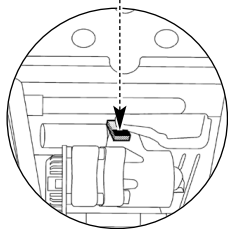

1) numéro de série du cadre

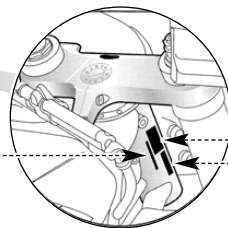

3) données d'homologation

1.4. Données d'identification

- 1) numéro de série du cadre
- 2) numéro de série du moteur
- 3) données d'homologation

► Identification de la moto

La moto est identifiable grâce au numéro de série du cadre. Pour les commandes de pièces détachées, il peut être nécessaire d'indiquer également le numéro de série du moteur, le code couleur et le numéro d'identification des clés.

Il est conseillé de noter les données principales dans les espaces ci-dessous:

CADRE N.: _____

MOTEUR N.: _____



► Identification des clés de la moto

Une clé est fournie en double exemplaire, elle sert pour le contacteur de démarrage et pour toutes les autres serrures. Garder le double en lieu sûr.

Il est indispensable de connaître le numéro d'identification de la clé pour en demander un double.

Il est conseillé de noter le numéro d'identification dans l'espace suivant:

CLÉ N.: _____

► Identification de la combinaison de couleur de la moto

Le code couleur est indispensable pour la commande de pièces détachées de la carrosserie. On peut lire ce code sur la plaque qui se trouve à l'intérieur de la queue.

Il est conseillé de noter le numéro d'identification du code couleur de la moto dans l'espace suivant:

CODE COULEUR: _____

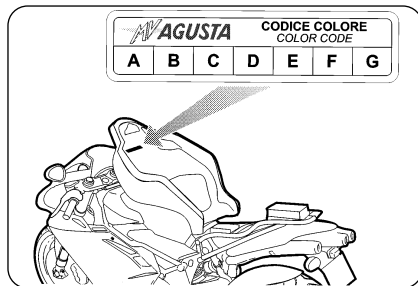
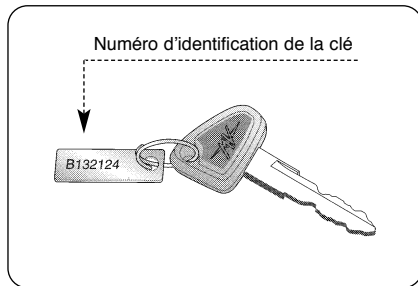



2.1. UTILISATION ADMISE DU VÉHICULE

La moto a été conçue pour une utilisation sur route et autoroute.



ATTENTION

Il est possible d'utiliser occasionnellement la moto sur piste mais pas dans le cadre de compétitions.

En raison des contraintes supplémentaires auxquelles est alors soumise la moto, nous vous recommandons de faire contrôler par un Centre d'Assistance MV Agusta les conditions de la moto avant et après l'emploi. Toute autre utilisation est interdite et expressément exclue.

Vous trouverez d'autres informations sur l'utilisation de la moto dans la section 4 du présent Manuel.

2.2. ENTRETIEN

Pour garantir l'efficacité et la fiabilité maximum du véhicule, il est indispensable d'effectuer les opérations d'entretien indiquées dans le Manuel d'Entretien.

MV Agusta insiste sur le fait que toutes les opérations d'entretien doivent être effectuées uniquement par un personnel qualifié appartenant à un Centre d'Assistance MV Agusta.

Si toutefois vous décidez de faire exécuter les interventions d'entretien par des ateliers non agréés, nous vous conseillons de vous assurer qu'ils disposent des instruments spécifiques nécessaires à de telles opérations.



ATTENTION

La garantie MV Agusta pourrait ne pas être valable si les ateliers non agréés ont effectué des interventions sur la moto de manière incorrecte et non prévue par les Circulaires Techniques et les Manuels d'Atelier MV Agusta.



2.3. ACCESSOIRES ET MODIFICATIONS



ATTENTION

Pour garantir la sécurité de ses Clients, MV Agusta interdit toute modification aux motos.

Toutefois, vous pouvez personnaliser votre moto en utilisant les Accessoires MV Agusta.



ATTENTION

L'installation de quelques-uns de ces accessoires peut annuler l'homologation de la moto et entraîner la non-utilisation sur route publique.

Dans le doute, nous vous invitons à contacter votre Concessionnaire de confiance pour identifier les accessoires les plus appropriés à vos exigences.

2.4. CHARGEMENT DU VÉHICULE

Le véhicule dans les versions **F4 1078 RR 312** et **F4 1000 R 312** est conçu pour l'emploi par le pilote uniquement, alors que les versions **F4 1078 RR 1+1 312** et **F4 1000 R 1+1 312** étendent l'utilisation au transport d'un passager. Pour une utilisation en toute sécurité et dans le respect des normes du code de la route, il est obligatoire de ne jamais dépasser le poids lourd total maximum admis des véhicules dont les valeurs sont données à la suite.

F4 1078 RR 312 / F4 1000 R 312

Poids total maximum	340 kg
Poids de charge maximum	110 kg

F4 1078 RR 1+1 312 / F4 1000 R 1+1 312

Poids total maximum	420 kg
Poids de charge maximum	180 kg



Le poids total maximum est la somme des poids suivants, conformément à la directive CEE 92/61:

- poids de la moto;
- poids du pilote;
- poids du passager (seulement pour F4 1078 RR 1+1 312 et F4 1000 R 1+1 312);
- poids de la charge et des accessoires.

**ATTENTION**

Etant donné que le chargement a un impact énorme sur la maniabilité, le freinage, les performances et les caractéristiques de sécurité de votre moyen de transport, prenez toujours les précautions suivantes.

- **NE SURCHARGEZ JAMAIS LE MOTOCYCLE !** L'utilisation d'une moto surchargée peut provoquer des dégâts aux pneumatiques, des pertes de contrôle ou des accidents graves. Vérifiez que le poids total du pilote, du passager, du chargement et des accessoires ne dépasse pas la charge maximum indiquée pour la moto.



3.1. Position des commandes et appareils

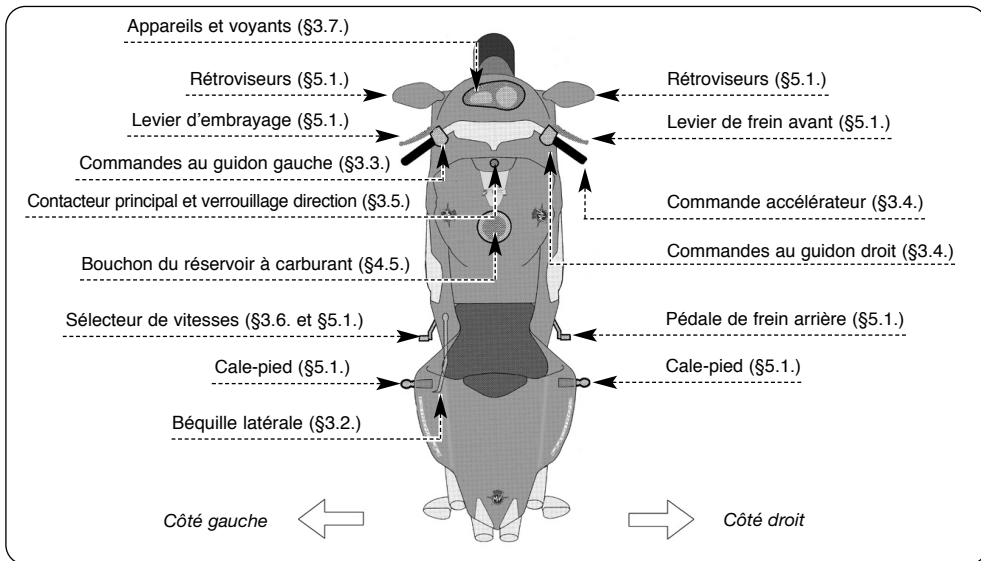



3.2. Béquille latérale

La béquille latérale est équipée d'un contacteur qui empêche à la moto de démarrer avec la béquille baissée.

Si le sélecteur de vitesses est actionné pour mettre la moto en mouvement lorsque le moteur tourne avec la béquille abaissée, le contacteur coupe le courant au moteur et provoque son arrêt.

Dans le cas où la moto se trouve en condition de stationnement (béquille baissée) avec un rapport engagé, le contacteur empêche le démarrage du moteur pour éviter tout risque de chute accidentelle.

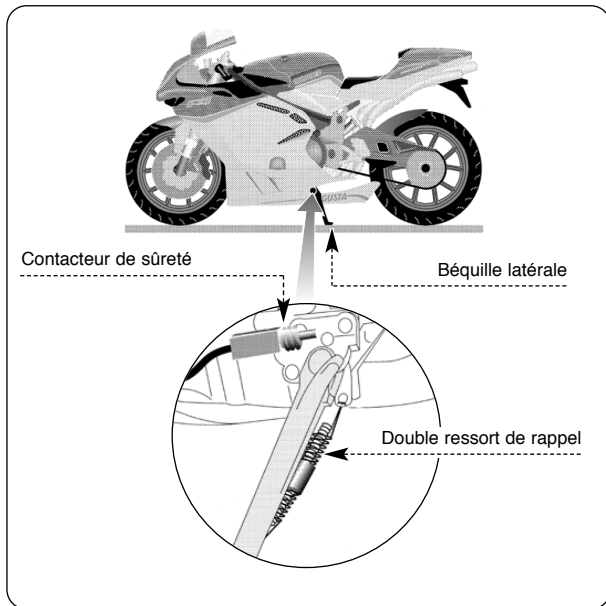



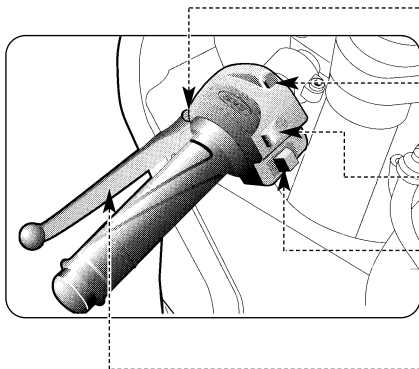

3.3. Commandes au guidon gauche



Bouton de clignotement des phares

Appuyer sur le bouton à répétition

Inverseur code/phare

Bouton sorti ■ : feu de croisement 
Bouton enfoncé ▬ : feu de route 

Bouton de l'avertisseur sonore

Appuyer pour utiliser l'avertisseur.

Poussoir de clignotants

En le déplaçant vers la droite ou la gauche on allume les clignotants correspondants. Le poussoir revient au centre, appuyer dessus pour éteindre les clignotants.

Levier d'embrayage

Tirer ou relâcher la poignée pour débrayer ou embrayer.



Bouton d'appel de phare

Cette fonction sert pour rappeler l'attention des autres usagers de la route en présence d'une situation dangereuse. Avec le feu de route éclairé, cette fonction est désactivée.

Bouton inverseur code/phare

C'est normalement la fonction code qui s'allume. Lorsque les de trafic et de route le permettent, il est possible d'allumer le feu de route en agissant sur l'inverseur.

Bouton de klaxon

Cette fonction sert pour attirer l'attention des autres usagers en cas de situations éventuelles de danger.

Levier des clignotants

Cette fonction permet de signaler aux autres usagers de la route, l'intention de changer de direction ou de voie de circulation.



ATTENTION

Si les clignotants ne sont pas utilisés ou coupés au moment opportun, il peut y avoir un risque d'accidents. En effet, les autres conducteurs pourraient tirer des conclusions erronées concernant la trajectoire du véhicule. Actionnez toujours les clignotants avant de tourner ou de changer de voie.

Veillez à les couper dès que la manoeuvre est terminée.

Levier d'embrayage

Ce levier, à travers un dispositif à contrôle hydraulique, permet de débrayer et d'embrayer.



3.4. Commandes au guidon droit

Coupe-circuit

Coupe le moteur et empêche le démarrage

Bouton du démarreur

Actionne le démarreur. Dès que le moteur part, il faut le relâcher.

Une fois le moteur en marche, il sert pour sélectionner les fonctions d'affichage.

Levier de démarrage à froid du moteur (Choke)

Tourner dans le sens des aiguilles d'un montre pour les démarrages à froid. Au bout de quelques secondes, le ramener dans sa position initiale.

Commande d'accélérateur

Tourner pour régler l'alimentation du moteur.

Levier de frein avant

Tirer vers la poignée pour actionner le frein avant.

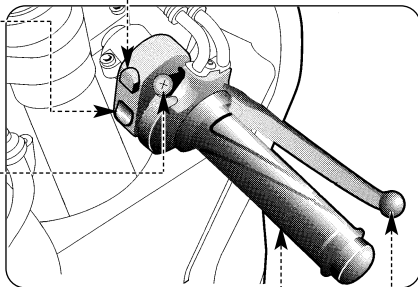

**Coupe-circuit moteur**

Cette fonction permet d'éteindre le moteur en cas d'urgence. De cette manière, le circuit d'allumage est coupé empêchant le redémarrage du moteur. Pour pouvoir démarrer, ramener le bouton en position de repos.

NOTE

En conditions normales, n'utilisez pas ce dispositif pour couper le moteur.

Bouton de démarrage moteur

Ce dispositif permet le démarrage du moteur. De plus, une fois le moteur démarré, il permet de sélectionner les fonctions de l'affichage du tableau de bord.

**RAPPEL**

Pour éviter des dommages à l'installation électrique, ne tenez pas le bouton enfoncé plus de 5 secondes consécutives.

Si le moteur ne démarre après plusieurs tentatives, consultez le chapitre "RECHERCHE DES PANNES" du livret.

Levier de démarrage à froid du moteur (Choke)

Le dispositif facilite le démarrage à froid en agissant sur l'alimentation.

NOTE

Cette fonction ne doit être maintenue actionnée que pour un temps limité et dans tous les cas dépendant de la température du moteur ainsi que de l'environnement. Lorsque le régime de ralenti est suffisant pour faire tourner le moteur sans qu'il s'éteigne, ramener la commande de démarrage à froid en position de repos.



Commande d'accélérateur

Ce dispositif permet d'agir sur l'alimentation du moteur pour varier son régime de rotation. Pour actionner le dispositif, il faut faire pivoter la poignée à partir de la position de repos qui correspond au régime de ralenti moteur.

En condition de démarrage à froid (Choke actionné), la répétée rotation de la poignée dans le sens de fermeture des gaz permet de ramener le levier de Choke en position de repos.

Levier frein avant

Cette commande provoque l'actionnement par l'intermédiaire d'un circuit hydraulique du système de freinage de la roue avant.



3.5. Contacteur principal et verrouillage de direction



ATTENTION

Ne pas appliquer de porte-clés ou autre à la clé de contact pour ne pas risquer de gêner la rotation de la direction.



ATTENTION

Ne jamais chercher à changer certaines fonctions du contacteur en cours de route sous peine de perdre le contrôle du véhicule.

Le contacteur à clé branche et coupe le circuit électrique et le verrouillage de la direction; les quatre positions de commande sont décrites à la suite.

Position "OFF"

Tous les circuits électriques sont coupés. La clé peut être retirée.

Position "ON"

Tous les circuits électriques sont branchés, les appareils et les voyants effectuent l'auto-diagnostic; le moteur peut démarrer. La clé peut être retirée.

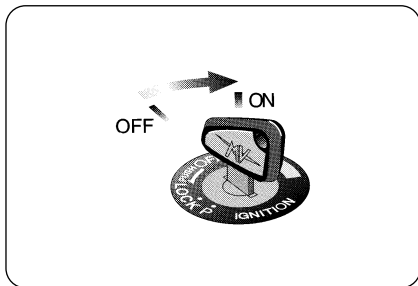

RAPPEL

Ne pas laisser la clé sur la position "ON" à moteur éteint pendant trop longtemps sous peine d'endommager les composants électriques de la moto.

**Position "LOCK"**

Braquer le guidon à droite ou à gauche. Pousser légèrement sur la clé et la tourner simultanément en position "LOCK".

Tous les circuits sont coupés et la direction est verrouillée. La clé peut être retirée.

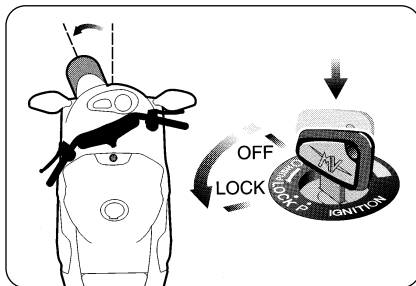

3 FR

Position "P"

Tourner la clé de la position "LOCK" à la position "P". Tous les circuits électriques sont coupés à l'exception des feux de stationnement (feux de positions) et la direction est verrouillée.

La clé peut être retirée.

**RAPPEL**

Ne pas laisser la clé sur la position "P" pendant trop longtemps pour éviter de décharger la batterie de la moto.

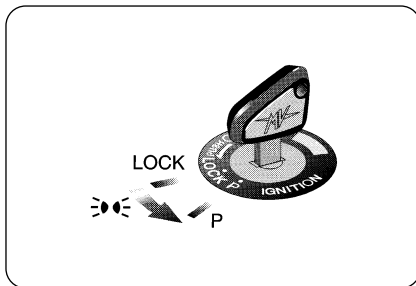



3.6. Sélecteur de vitesses

La position **N** "Neutral" correspond au point mort signalé par le voyant correspondant sur le tableau de bord. En déplaçant le sélecteur vers le bas, on engage la première vitesse. De la même manière, en déplaçant le sélecteur vers le haut, on passe la seconde vitesse et ainsi de suite à mesure que l'on déplace le sélecteur vers le haut, on passe dans l'ordre toutes les vitesses suivantes jusqu'à la sixième.

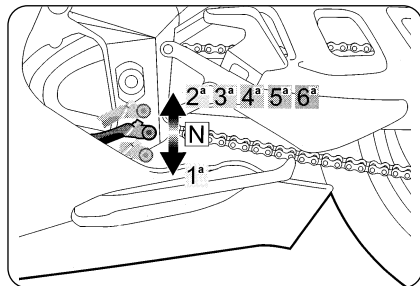



3.7. Appareils et voyants

Les appareils et les voyants sont activés lorsque la clé de contact est mise sur "ON". Après un check-up initial (~7 secondes), les informations correspondent aux conditions générales de la moto à ce moment là.

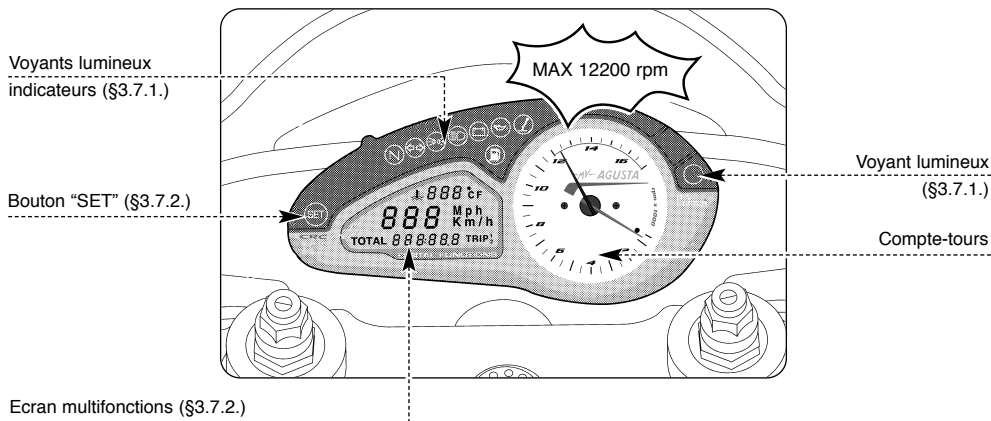



3.7.1. Voyants lumineux

Voyant feu de route (bleu)

Il s'éclaire lorsque le feu de route est allumé.

Voyant de charge batterie (rouge)

Il s'éclaire lorsque l'alternateur ne fournit pas le courant électrique suffisant pour charger la batterie.

Voyant feu de croisement (vert)

Il s'éclaire lorsque le feu de croisement est allumé.

S'il s'allume pendant la marche, s'adresser à un centre de réparation agréé.

Voyant d'ouverture de la béquille latérale (rouge)

Il s'allume lorsque la béquille est baissée.

Voyant de point mort (vert)

Il s'allume lorsque les vitesses sont au point mort "Neutral".

Voyant limiteur de tours (rouge)

Il s'allume lorsque le régime moteur dépasse 12.200 tr/mn; le limiteur de tours intervient à 13.000 tr/mn.

Voyant des feux clignotants (vert)

Il s'éclaire pendant le fonctionnement des clignotants.

Voyant de pression d'huile moteur (rouge)

Il s'allume lorsque la pression d'huile est insuffisante.

Voyant de réserve carburant (orange)

Il s'éclaire lorsqu'il reste environ 4 litres de carburant dans le réservoir.



Danger - Attention: S'il s'allume en marche, il faut s'arrêter immédiatement, contrôler le niveau d'huile et, si nécessaire le font rajouter par un centre de réparation agréé MV Agusta (voir §3.8.). Si le voyant s'allume même lorsque le niveau est correct, ne pas continuer à rouler et contacter un centre de réparation agréé.

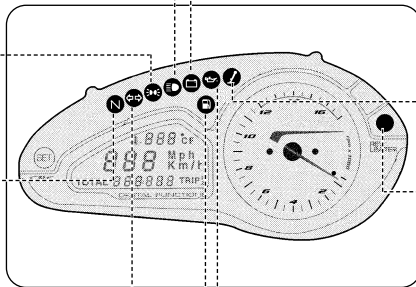



3.7.2. Affichage multifonctions

Compteur de vitesse

Il indique la vitesse qui peut être indiquée en kilomètres/heure (km/h) ou en miles/heure (Mph). La valeur maximum sur l'échelle est de 350 km/h (218 Mph).

Bouton "SET"

En appuyant dessus, il permet de sélectionner les chiffres de l'écran pour effectuer les réglages. En appuyant une seconde fois, il permet de confirmer les chiffres saisis.

En poussant simultanément ce bouton et celui du démarreur, on met en service la fonction de chronomètre.

Totaliseur kilométrique "TOTAL"

Il indique le nombre total de kilomètres parcourus; de 0 à 99999,9 (km ou mi)

Compteur kilométrique partiel 1 "TRIP 1"

Indique les kilomètres d'un parcours; de 0 à 9999.9 (km ou mi)

Compteur kilométrique partiel 2 "TRIP 2"

Indique les kilomètres d'un parcours ; de 0 à 9999.9 (km ou mi)

Montre de bord Indique l'heure (0-24)

Thermomètre

Indique la température du liquide de refroidissement. La valeur peut apparaître en degrés centigrades (°C) ou encore en degrés fahrenheit (°F).

L'échelle est comprise entre 40° et 140°C (104° et 284°F):

- en dessous de 40°C (104°F) l'indication n'apparaît pas mais trois tirets clignotants s'affichent, c'est le signal d'une température très basse;
- entre 40° et 49°C (104° et 120° F), l'affichage clignote, c'est le signal d'une température basse;
- entre 50° et 111°C (122° et 232° F), l'affichage est fixe;
- entre 112° et 140°C (234° et 284° F), l'affichage clignote, c'est le signal d'une température haute.

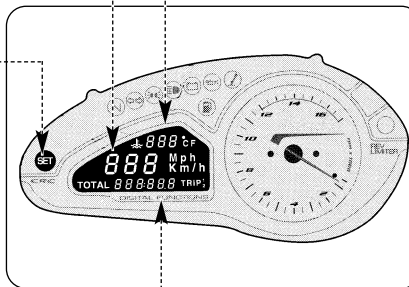

Danger - Attention: si la température dépasse les 120°C (248°F), couper le moteur et contrôler le niveau de liquide de refroidissement. Dans le cas où il serait nécessaire de le rectifier, contacter un centre de réparation agréé MV Agusta (voir §3.8.). Si le voyant s'allume bien que le niveau soit correct, ne pas continuer à rouler et contacter un centre de réparation agréé MV Agusta.



3.8. Tableau des lubrifiants et liquides

Description	Produit préconisé	Caractéristiques
Huile moteur	AGIP RACING 4T 10W/60 (*)	SAE 10W/60 - API SJ
Liquide de refroidissement	AGIP ECO - PERMANENT	Glycol-éthylène dilué à 50% avec eau distillée
Liquide d'embrayage et freins	AGIP BRAKE FLUID DOT4	DOT4
Huile de graissage de la chaîne	MOTUL CHAIN LUBE ROAD	-

* : Pour la disponibilité du produit conseillé, MV Agusta conseille de s'adresser directement aux propres concessionnaires autorisés. L'huile moteur AGIP Racing 4T 1W/60 a été réalisée spécialement pour le moteur de la motocyclette F4 1000. Au cas où le lubrifiant décrit ne serait pas possible à trouver, MV Agusta conseille d'utiliser des huiles complètement synthétiques avec des caractéristiques conformes ou supérieures aux normes suivantes:

- Conforme API SJ
- Conforme ACEA A3
- Conforme JASO MA
- Gradation SAE 20 W-50 ou 10 W-60

NOTE

Les caractéristiques indiquées ci-dessus doivent être indiquées seules ou avec d'autres sur l'emballage de l'huile.





4.1. Utilisation de la moto

Cette partie du livret expose les principaux points qui permettent une utilisation correcte de la moto.



ATTENTION

La Votre moto montre caractéristiques élevées de puissance et de performances; pour l'utilisation, il est donc requise un niveau adéquat de connaissance du véhicule. Lors de la première utilisation de la moto, il est nécessaire de garder une attitude prudente. Une agressive ou impulsive attitude de conduite peut augmenter les risques d'accidents et représenter un danger pour Votre sécurité et celle d'autrui.



ATTENTION

LES LIMITATIONS CONCERNANT L'UTILISATION ADMISE DU VEHICULE SONT REPORTÉES DANS LA SECTION "INFORMATIONS POUR LA SÉCURITÉ".



RAPPEL

Les températures élevées provoquées par l'utilisation du véhicule sur des circuits de course ont pu compromettre l'efficacité de le convertisseur catalytique et de l'échappement; donc, nous suggérons assembler un dispositif d'échappement spécial à l'aide du véhicule sur des circuits de course.



4.2. Rodage



Prudence - Précautions: le non respect des indications suivantes peut porter préjudice à la durée et aux performances de la moto.

Le rodage est communément considéré comme une phase appliquée uniquement au moteur. En réalité, il est nécessaire également pour d'autres parties importantes de la moto, en particulier les pneumatiques, les freins, la chaîne de transmission etc. Durant les premiers kilomètres adopter une conduite tranquille.

De 0 à 500 km (de 0 à 300 mi) (A)

Pendant cette période, varier fréquemment le régime de rotation du moteur. Si possible, préférer les parcours en colline légère avec beaucoup de virages et éviter les longues lignes droites.

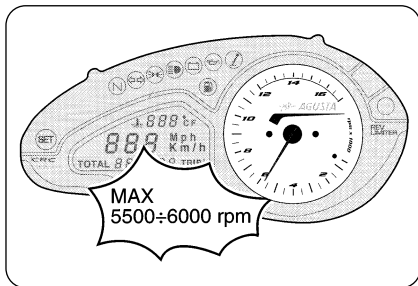

ATTENTION

Les pneumatiques neufs doivent être soumis à un rodage adéquat pour atteindre une efficacité complète. Éviter les accélérations, les virages et les freinages brusques pendant les premiers 100 km. Si la période de rodage initial des pneus n'est pas respectée, il y a risque de dérapage ou de perte de contrôle du véhicule entraînant un grave danger d'accident.



❑ De 500 à 1000 km (de 300 à 600 mi)

Pendant cette période, éviter les efforts prolongés du moteur.

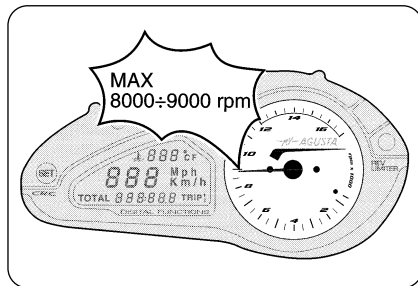

❑ De 1000 à 2500 km (de 600 à 1600 mi)

Pendant cette période, il est possible de pousser un peu plus le moteur sans toutefois dépasser le régime indiqué.

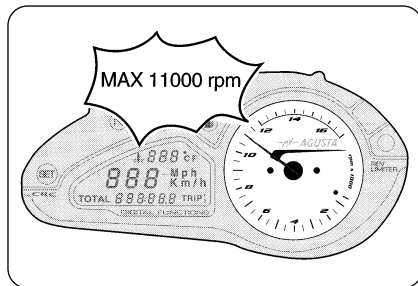



4.3. Démarrage



ATTENTION

Faire fonctionner le moteur dans un espace clos peut être dangereux. Les gaz d'échappement contiennent du monoxyde de carbone, un gaz incolore et inodore qui peut provoquer la mort ou des accidents graves. Faire fonctionner le moteur uniquement à l'extérieur, à l'air libre.

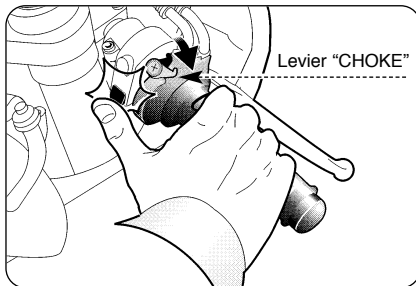

- Tourner le contacteur principal en position "ON", les voyants et indicateurs effectuent l'autodiagnostic. Pendant cette phase, veiller à ce que tous les voyants du tableau de bord s'allument. Pour que le système de sûreté du circuit d'allumage donne l'autorisation au démarrage, l'une de ces conditions doit être remplie:
- Le sélecteur est en position de point mort.
 - Le sélecteur se trouve sur une vitesse avec le débrayage tiré et la béquille latérale levée.

❑ Démarrage à froid

- Tourner le levier "CHOKE" sans tourner la poignée d'accélérateur et appuyer sur le bouton.



► Dès que le moteur démarre, relâcher le bouton et après un bref chauffage, ramener le levier sur sa position initiale.

Démarrage à chaud

- Appuyer sur le bouton sans tourner la poignée de l'accélérateur.
- Dès que le moteur tourne, relâcher le bouton.



Rappel – Précautions:

- Pour éviter les dommages au circuit électrique, ne pas actionner le démarreur plus de 5 secondes consécutives.
- Ne pas faire tourner trop longtemps le moteur lorsque la moto est à l'arrêt. La surchauffe peut endommager les composants intérieurs du moteur. Il est préférable de chauffer le moteur en se mettant en route à une allure réduite.
- Pour préserver au maximum la durée de vie du moteur, ne pas accélérer à fond lorsque le moteur est froid.

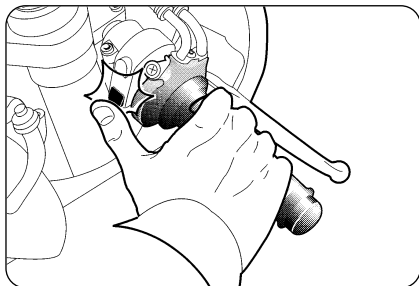



4.4. Sélection et modification des fonctions d'affichage

L'instrumentation prévoit la possibilité d'intervenir sur quelques-uns des paramètres principaux de mesure et de mettre en service la fonction chronomètre.

Les opérations possibles sont:

- Sélection des fonctions:

Totaliseur kilométrique Totale "TOTAL"

Compteur kilométrique Partiel 1 "TRIP 1"

Compteur kilométrique Partiel 2 "TRIP 2"

Horloge

Chronomètre

- Réglage des unités de mesures relatives à:

Vitesse

Distance parcourue

Température

- Mise à zéro des fonctions compteurs kilométriques partiels:

Compteur kilométrique Partiel 1 "TRIP 1"

Compteur kilométrique Partiel 2 "TRIP 2"

- Réglage de la fonction horloge

- Mise en service de la fonction chronomètre

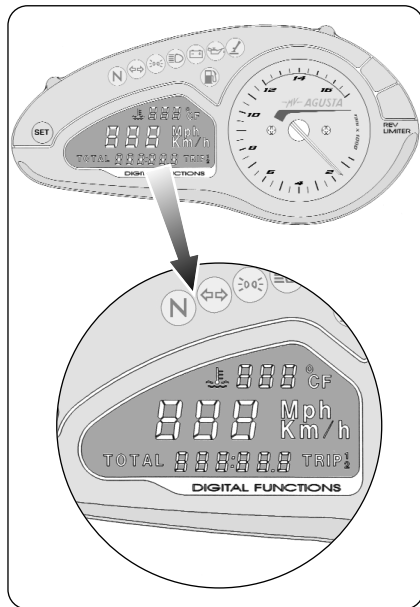



4.4.1. Sélection des fonctions d'affichage

La sélection concerne les fonctions:

- Totaliseur kilométrique "TOTAL"
- Compteur kilométrique partiel 1 "TRIP 1"
- Compteur kilométrique partiel 2 "TRIP 2"
- Horloge
- Chronomètre

► Pour l'affichage des fonctions "TOTAL", "TRIP 1" et "TRIP 2", appuyer sur le bouton du démarreur. En agissant sur ces boutons, les fonctions s'affichent en mode cyclique. Sélectionner la fonction désirée.

► L'affichage de la fonction chronomètre est illustré à la page suivante.

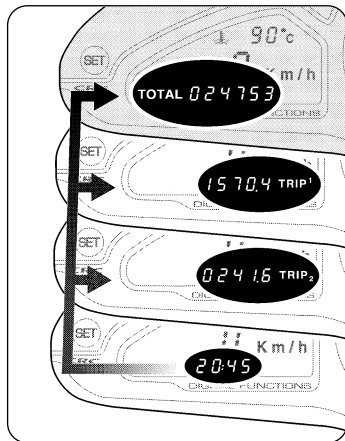
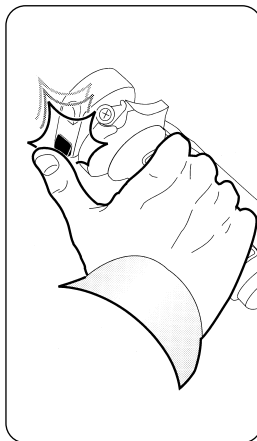
4^{RE}

ATTENTION

Les opérations de modification ou de réglage des fonctions d'affichage doivent être effectuées avec le moteur allumé, le sélecteur de vitesses au point mort, la moto à l'arrêt et les pieds au sol. Il est interdit de changer les réglages de l'affichage en cours de route.



❑ Chronomètre

► La mise en service du chronomètre est possible uniquement si l'une des fonctions suivantes est affichée:

- Totaliseur kilométrique "TOTAL"
- Compteur kilométrique Partiel 1 "TRIP 1"
- Compteur kilométrique Partiel 2 "TRIP 2"
- Horloge

► Appuyer simultanément sur le bouton "SET" et sur le bouton du démarreur pendant au moins 2 secondes.

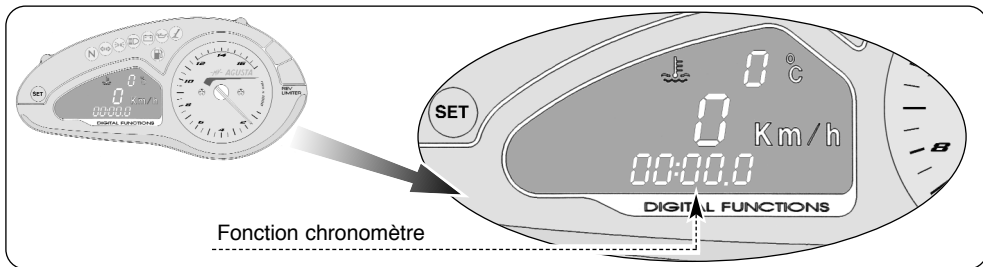
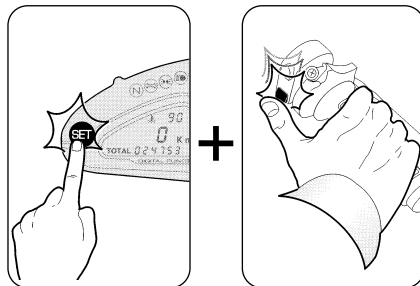

Le fonctionnement du chronomètre est illustré aux paragraphes suivants (§ 4.4.5).



4.4.2. Réglage de l'unité de mesure

Il est possible de modifier l'unité de mesure.



ATTENTION

Les opérations de modification ou de réglage des fonctions d'affichage s'effectuent moteur en marche, sélecteur au point mort, moto à l'arrêt et pieds à terre. Il est interdit de changer les réglages de l'affichage pendant la marche.

□ Le compteur de vitesses (km/h - Mph)

- ▶ Appuyer de manière répétée sur le bouton du démarreur jusqu'à l'affichage de la fonction totaliseur kilométrique "TOTAL".
- ▶ Appuyer sur le bouton "SET"; l'unité de mesure du compteur de vitesse commence à clignoter.

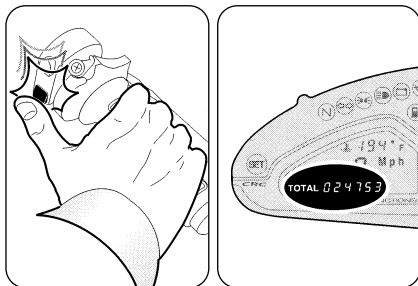
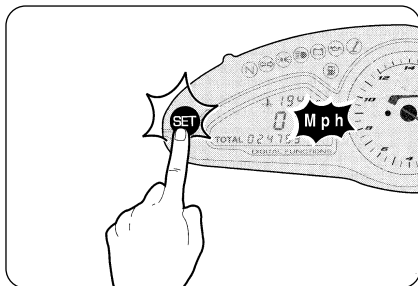
4^{LE}



► Appuyer sur le bouton du démarreur pour passer de km/h à Mph ou inversement. En modifiant l'unité de mesure du compteur de vitesse, celle des compteurs-kilométriques (totaliseur ou partiels) est automatiquement modifiée.

Rappel: 1 mi = 1,609 km

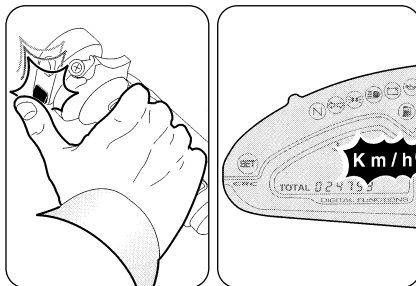

► Appuyer sur le bouton "SET"; l'unité de mesure du compteur de vitesses est validée et l'unité de mesure du thermomètre commence à clignoter. Il est possible de passer au réglage suivant.

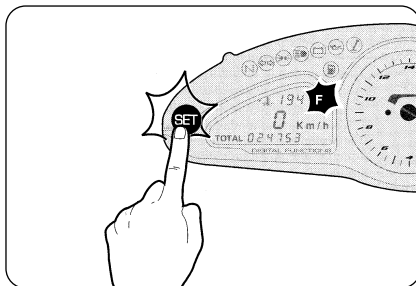

FR 4



□ Thermomètre (° C - ° F)

- ▶ Appuyer sur le bouton du démarreur pour passer de °C à °F ou inversement.

Rappel : $T (°F) = 1,8 \cdot t(°C) + 32$

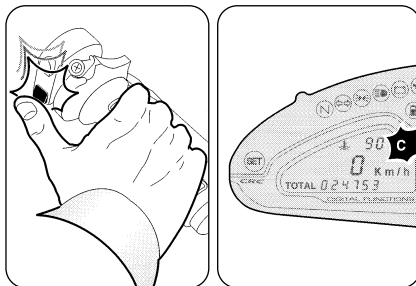

4

- ▶ Appuyer sur le bouton "SET" pour valider l'unité de mesure.

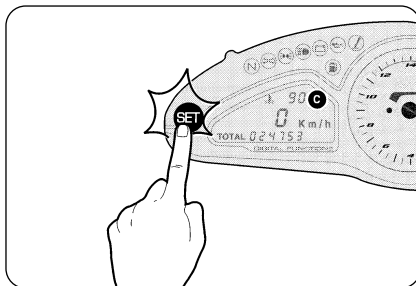



4.4.3. Mise à zéro des fonctions de compteurs kilométriques partiels

Les valeurs des fonctions “TRIP1” et “TRIP2” peuvent se remettre à zéro de la manière suivante.



ATTENTION

Les opérations de modification ou de réglage des fonctions d’affichage doivent être effectuées avec le moteur allumé, le sélecteur de vitesses au point mort, la moto à l’arrêt et les pieds au sol. Il est interdit de changer les réglages de l’affichage en cours de route.

► Appuyer sur le bouton du démarreur pour actionner la fonction “TRIP 1”.

► Appuyer sur le bouton du démarreur pendant un laps de temps supérieur à 4 secondes; la valeur “TRIP1” se met à clignoter.

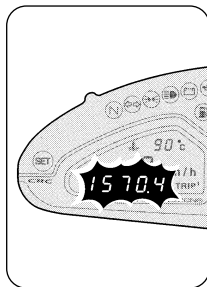
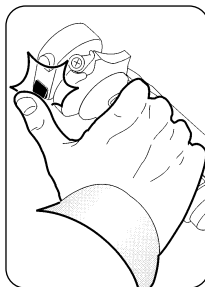
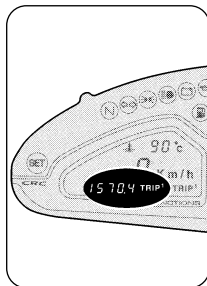
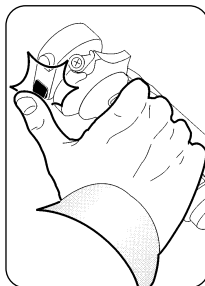



► En appuyant maintenant sur le bouton du démarreur, pendant un laps de temps inférieur à 4 secondes, la valeur se remet à zéro. Si le bouton reste appuyé plus de 4 secondes, la procédure de remise à zéro est interrompue.

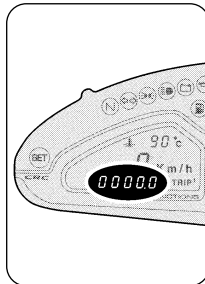
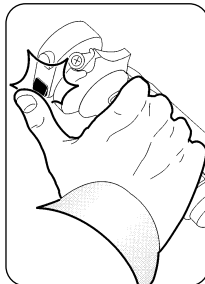

► En appuyant sur le bouton du démarreur, mettre en service la fonction "TRIP 2".

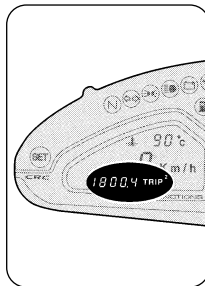
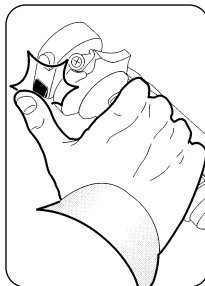



► Appuyer sur le bouton du démarreur pendant un laps de temps supérieur à 4 secondes; la valeur "TRIP 2" commence à clignoter.

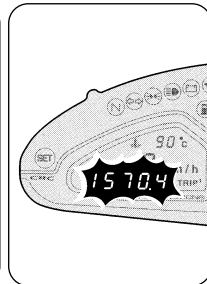
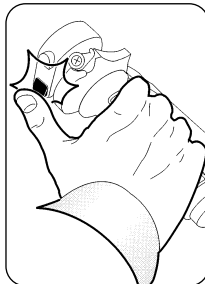

► En appuyant maintenant sur le bouton du démarreur, pendant un laps de temps inférieur à 4 secondes, la valeur se remet à zéro. Si le bouton reste appuyé plus de 4 secondes, la procédure de remise à zéro est interrompue.

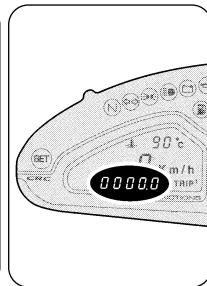
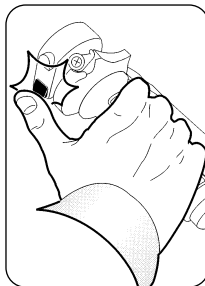



4.4.4. Réglage de la fonction horloge

Il est possible d'effectuer le réglage de l'horloge.



ATTENTION

Les opérations de modification ou de réglage des fonctions d'affichage doivent être effectuées avec le moteur allumé, le sélecteur de vitesses au point mort, la moto à l'arrêt et les pieds au sol. Il est interdit de changer les réglages de l'affichage en cours de route.

► Appuyer de manière répétée sur le bouton du démarreur du moteur jusqu'à l'affichage de la fonction horloge.

► Appuyer sur le bouton "SET", le premier chiffre de l'heure commence à clignoter.

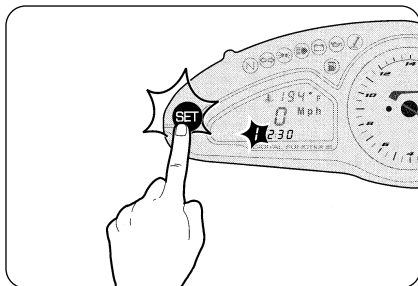
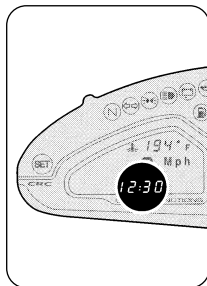
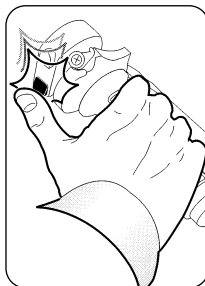



► Appuyer sur le bouton du démarreur pour le réglage du nombre. Relâcher dès que le nombre correct est atteint.

NOTE

Pour obtenir le défilement rapide des nombres sélectionnés, tenir le bouton du démarreur enfoncé pendant plus de deux secondes.

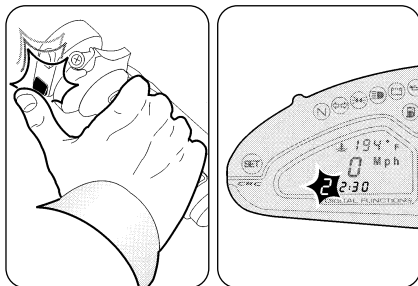

- FR 4** ► Appuyer sur le bouton “SET” pour confirmer ou pour procéder au réglage du chiffre suivant.
► Répéter le procédé pour régler le second chiffre des heures, le premier et le second chiffre des minutes.
► Appuyer sur le bouton “SET” pour valider le réglage de l’heure et interrompre la sélection (le clignotement).

NOTE

L’instrumentation dispose d’une mémoire intégrale qui conserve tous les paramètres même à moteur coupé. A l’exception de l’horloge, qui est remise à zéro, tous les autres paramètres restent en mémoire même en cas de débranchement de la batterie.

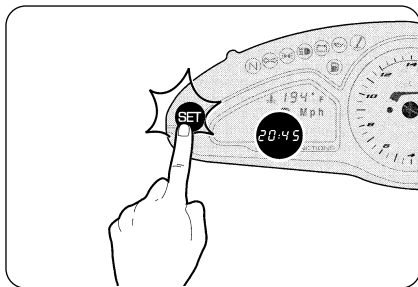



4.4.5. Chronomètre

► La mise en service du chronomètre est possible uniquement si l'une des fonctions suivantes est affichée :

- Totaliseur kilométrique Total "TOTAL"
- Compteur kilométrique 1 Partiel 1 "TRIP 1"
- Compteur kilométrique 2 Partiel 2 "TRIP 2"
- Horloge

► Appuyer simultanément sur le bouton "SET" et sur le bouton du démarreur pendant au moins 2 secondes. Ceci permet de mettre le chronomètre en service. L'écran affiche les chiffres "00.00.0".



ATTENTION

Les opérations de modification ou de réglage des fonctions d'affichage s'effectuent moteur en marche, sélecteur au point mort, moto à l'arrêt et pieds à terre. Il est interdit de changer les réglages de l'affichage pendant la marche.

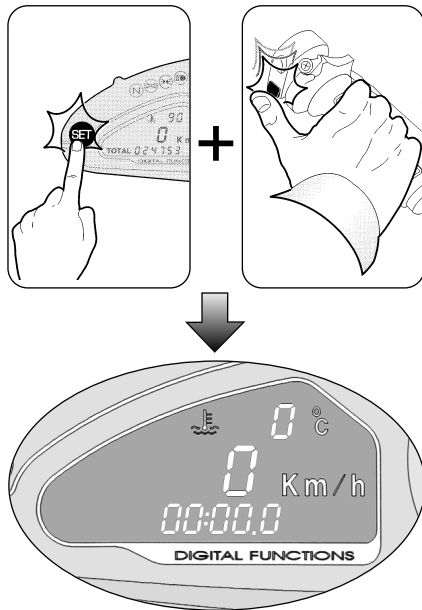



□ Saisie de données

Après avoir mis la fonction chronomètre en service, il est possible de commencer la saisie des données en actionnant le bouton d'appel de phare. L'exécution de cette opération détermine le début du chronométrage. Les points qui séparent les minutes des secondes commencent à clignoter. L'instrument est en train de mesurer les temps.

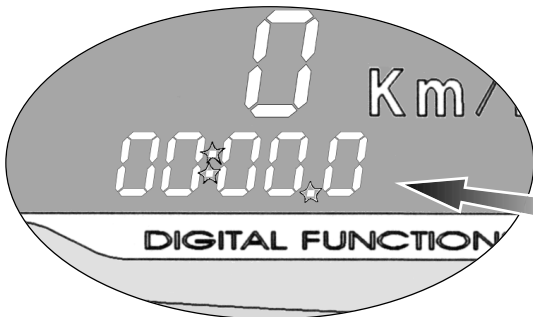
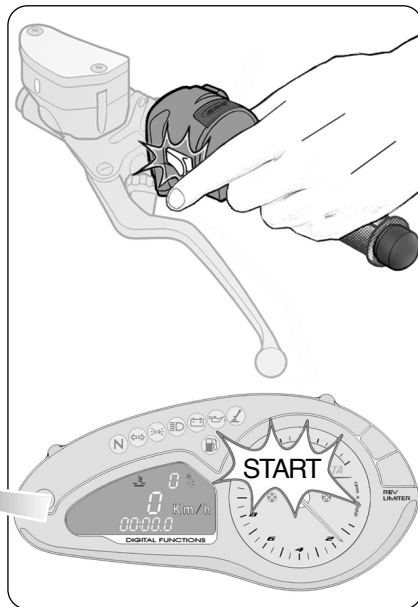



En appuyant de nouveau sur le bouton d'appel de phare, on enregistre le chronométrage relatif au 1^o tour parcouru. Simultanément, l'instrument commence à chronométrer le temps relatif au second tour.

Le chronométrage relatif au premier tour est conservé en mémoire et reste affiché sur l'écran jusqu'à la saisie du tour suivant.

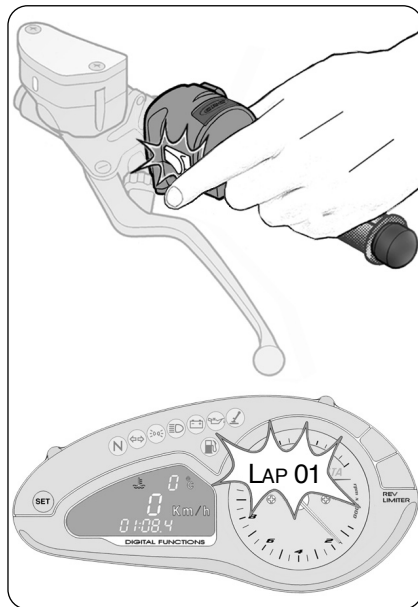



Au fur et à mesure que l'on continue à chronométrer, un temps est enregistré à chaque actionnement de l'appel de phare.

Le chronomètre peut enregistrer jusqu'à un maximum de 80 temps consécutifs.

Dans le cas où le temps à peine enregistré serait inférieur à celui du tour précédent, le chronomètre affiche le symbole " - " devant les chiffres.

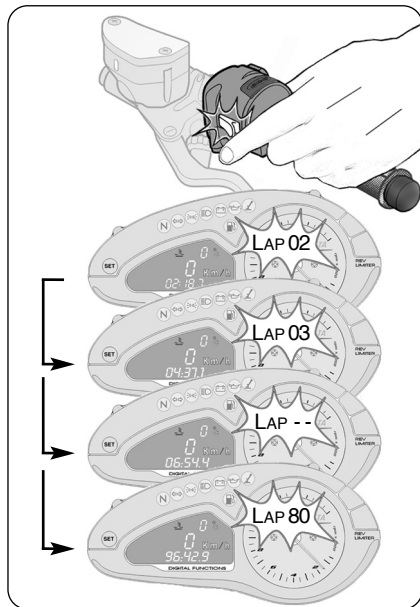
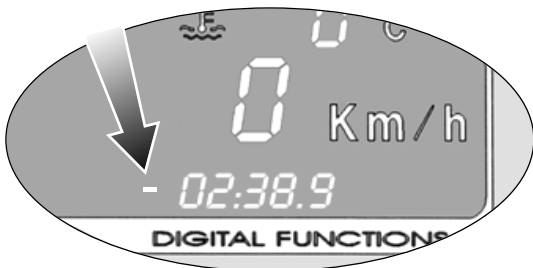



□ Affichage des Données

Une fois la saisie des temps terminée, il est possible d'afficher les différents temps.

NOTE

Attention à ne pas couper le moteur. Une éventuelle coupure du moteur, provoquerait la perte de toutes les données enregistrées.

► Appuyer sur le bouton "SET" pendant un temps compris entre 0,25 et 2 secondes.

NOTE

En appuyant sur le bouton SET pendant un laps de temps supérieur à 2 sec., toutes les données enregistrées s'effacent.

► L'écran affiche "LAP 01" puis, une seconde après, le temps du 1° tour mémorisé.

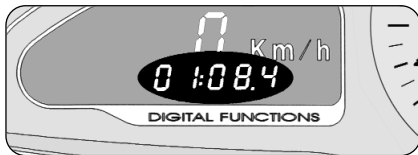
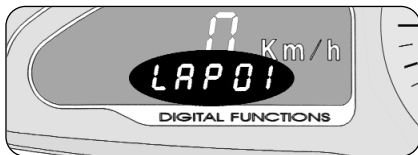
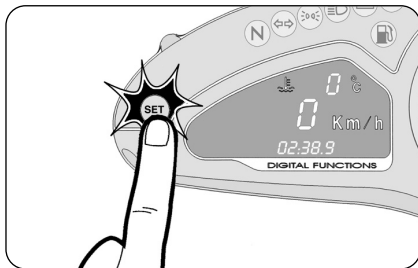



► En actionnant le bouton d'appel de phare, l'écran affiche "LAP 02" et une seconde après, le temps du 2° tour mémorisé.

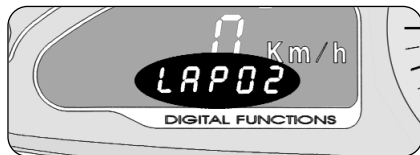
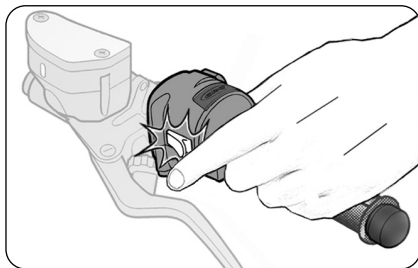

► En continuant à appuyer sur le bouton d'appel de phare, les temps des tours suivants s'affichent l'un après l'autre selon le même principe. Après l'affichage du temps du dernier tour mémorisé, on revient à l'affichage du temps du 1° tour ("LAP 01").

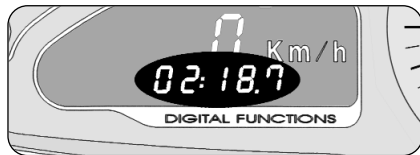



□ Affichage des données du tour le plus rapide

- ▶ Faire en sorte que l'écran se trouve en modalité d'affichage des temps et que le temps relatif au premier tour mémorisé soit affiché ("LAP 01").
- ▶ Appuyer sur le bouton "SET" pendant un temps égal ou supérieur à 2 secondes.

NOTE

Appuyer sur le bouton "SET" pendant moins de 2 secondes pour sortir du mode d'affichage des données.

- ▶ L'écran affiche le numéro du tour correspondant au meilleur temps enregistré puis le temps en question une seconde après.

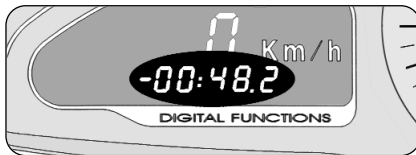
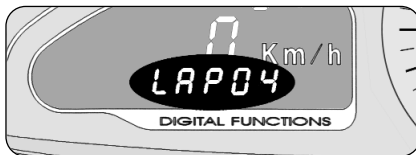
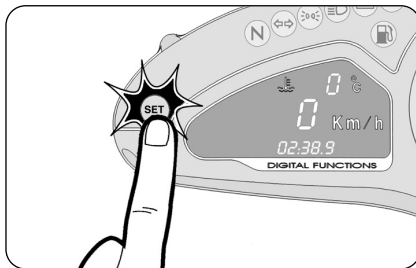



□ Retour au mode de saisie de données

► Appuyer sur le bouton "SET" pendant un temps compris entre 0,25 et 2 secondes pour revenir au mode de saisie des données. De cette manière, il est possible de continuer à mesurer les temps ou de commencer une nouvelle session de chronométrage.

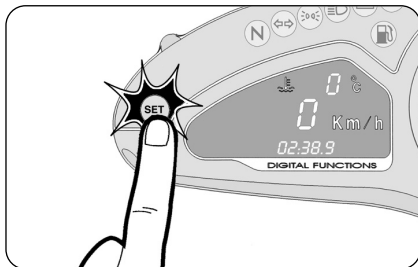

► Après avoir appuyé sur le bouton "SET", l'écran affiche les temps du dernier tour mémorisé.

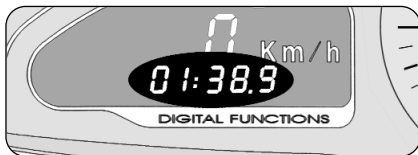

NOTE

Si aucune donnée n'a été mémorisée, l'écran affiche "00:00.0" au moment du retour au mode saisie de données.

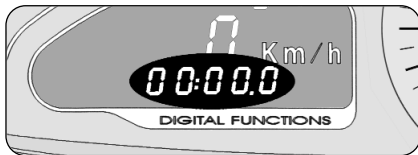



❑ Effacement des données

L'opération d'effacement de toutes les données mémorisées s'effectue en appuyant sur la touche "SET" pendant 2 secondes.

NOTE

Une fois effacées, les données ne sont plus récupérables. L'opération de nettoyage peut s'effectuer également pendant les phases où le chronomètre est en service. Dans ces situations, le chronométrage s'interrompt.

Une fois l'effacement effectué, le chronomètre affiche "00.00.0".

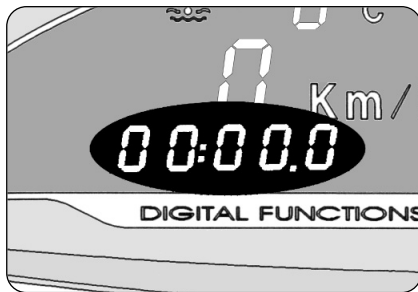
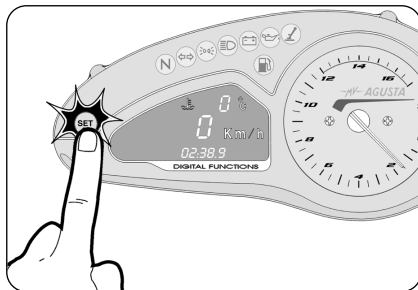



4.5. Approvisionnement en carburant



Danger - Attention: l'essence et ses vapeurs sont extrêmement inflammables et nocifs. Eviter le contact et l'inhalation. Pendant l'approvisionnement, couper le moteur, ne pas fumer, tenir à distance les flammes, étincelles et sources de chaleur. Effectuer l'approvisionnement à l'air libre ou dans un local suffisamment aéré.



Rappel - Précaution: utiliser exclusivement de l'essence super sans plomb avec un indice d'octane (R.O.N.) de 95 ou plus. Cette nécessité est rappelé par une pastille verte sur le côté inférieur du bouchon du réservoir.

- ▶ Soulever le cache poussière.
- ▶ Introduire la clé, tourner dans le sens des aiguilles d'une montre et soulever le couvercle.
- ▶ Une fois l'approvisionnement effectué, pousser le bouchon vers le bas en tournant simultanément la clé dans le sens des aiguilles d'une montre pour faciliter la fermeture, puis relâcher la clé et l'extraire.

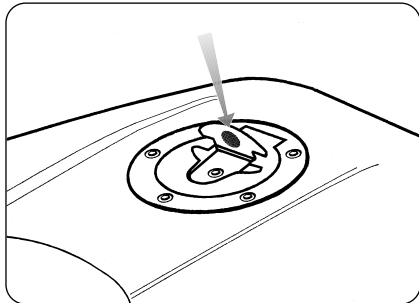
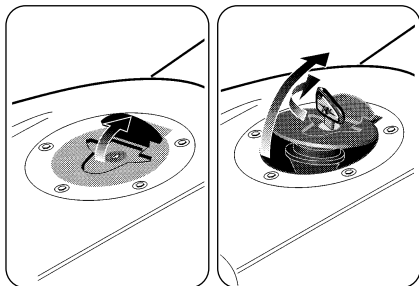

**ATTENTION**

Un remplissage excessif du réservoir peut faire déborder le carburant à cause de l'expansion due à la chaleur du moteur ou à l'exposition de la moto à la lumière du soleil. Les écoulements éventuels de carburant peuvent provoquer des incendies. Le niveau de carburant dans le réservoir ne doit jamais dépasser la base de l'embout de remplissage.



Rappel - Précaution: sécher immédiatement avec un chiffon propre le carburant éventuellement renversé, car il peut détériorer les peintures ou les plastiques.

**ATTENTION**

Vérifier que le bouchon du réservoir à carburant est fermé correctement avant d'utiliser le véhicule.

4^{LE}**4.6. Accès à la boîte à gants**

- ▶ Introduire la clé.
- ▶ Appuyer sur l'élément de carénage arrière et tourner simultanément la clé en sens d'horloge.
- ▶ Soulever légèrement l'élément par l'arrière, le faire coulisser vers l'arrière et le soulever jusqu'au contact avec le réservoir.

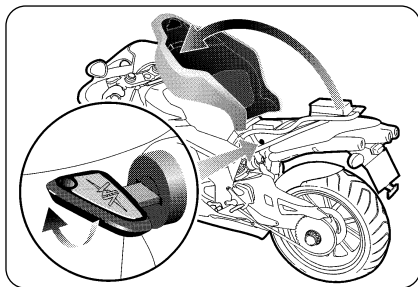



4.7. Stationnement de la moto

☐ Stationnement avec béquille latérale



RAPPEL

- Garer la moto en conditions de sécurité et sur un terrain stable.
- Pour le stationnement en côte, garer la moto avec la roue avant en amont et la première vitesse engagée. Ne pas oublier de remettre le sélecteur de vitesses au point mort avant de redémarrer la moto.
- Ne pas laisser le véhicule sans surveillance avec la clé sur le contact.

► Abaisser la béquille avec le pied jusqu'à la butée et incliner lentement la moto pour mettre le pied d'appui au contact du sol.

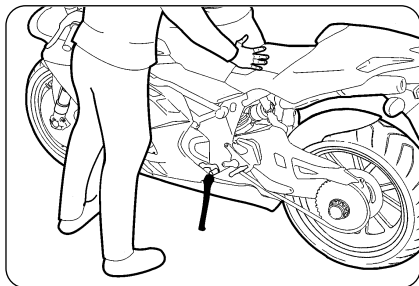

**ATTENTION**

Lorsque le véhicule stationne sur la béquille latérale, il est dangereux de s'asseoir dessus et de peser avec tout le poids du corps sur l'unique appui de stationnement.

**ATTENTION**

Avant de se mettre en route, vérifier le fonctionnement de l'interrupteur de sûreté en s'assurant que le voyant d'ouverture de la béquille latérale sur le tableau de bord s'éteint. Dans tous les cas, vérifier que la béquille est bien rentrée. En cas de fonctionnement défectueux, faire contrôler le dispositif par un concessionnaire MV Agusta avant d'utiliser la moto.

□ Stationnement avec la béquille arrière

Introduire l'axe de béquille dans l'orifice de l'axe de roue arrière du côté gauche de la moto. Appuyer la béquille au sol et en forçant dessus, soulever le véhicule jusqu'à ce qu'il se stabilise.

**RAPPEL**

Cette opération doit être effectuée par deux personnes.

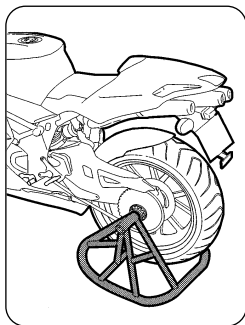
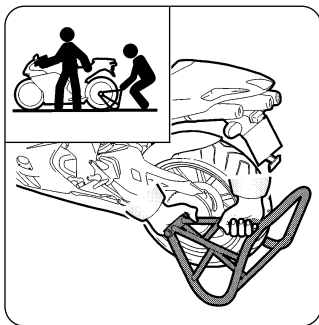



5.1. Liste des réglages

La moto dispose d'une grande diversité de réglages qui peuvent améliorer l'ergonomie, l'assiette et la sécurité.

Toutefois, étant donné qu'un réglage incorrect de pièces particulièrement importantes peut engendrer une situation de danger, quelques-uns des réglages sont réservés aux Centres d'Assistance MV Agusta.



ATTENTION

Tous les réglages s'effectuent à l'arrêt.



(F) Réglage du rétroviseur (§5.5.)

(A) Réglage du levier d'embrayage (§5.4.)

(F) Réglage du rétroviseur (§5.5.)

(C) Réglage du cale-pieds droit (§5.2.)

(E) Réglage de la pédale de frein arrière (§5.2.)

(B) Réglage de la pédale de frein avant (§5.3.)

(G) Réglage de l'amortisseur de direction (§5.6.)

(D) Réglage du sélecteur de vitesses (§5.2.)

(L) Réglage de la suspension arrière (§5.8.)

(N) Orientation du phare (§5.9.)

(M) Réglage de la chaîne (§5.2.)

(C) Réglage du cale-pieds gauche (§5.2.)

(H) Réglage de la suspension avant (§5.7.)

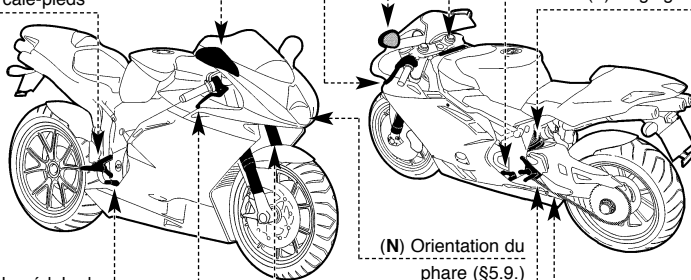



5.2. Tableau des réglages



A - Réglage du levier d'embrayage: pour améliorer la prise en fonction des nécessités du pilote (§5.4.).



B - Réglage du levier de frein avant: pour améliorer la prise en fonction des nécessités du pilote (§5.3.).



C - Réglage des cale-pieds (droit et gauche): pour améliorer la position des pieds en fonction des exigences du motocycliste.



D - Réglage du sélecteur de vitesses: pour améliorer le mouvement de commande en fonction des nécessités du pilote.



E - Réglage de la pédale de frein arrière: pour améliorer le mouvement de commande en fonction des nécessités du pilote.



F - Réglage des rétroviseurs: pour améliorer l'orientation (§5.5.).



G - Réglage de l'amortisseur de direction: pour adapter la dureté de la direction aux préférences du pilote (§5.6.).



H - Réglage de la suspension avant: pour adapter la réponse aux préférences du motard, on peut régler:

- la précharge du ressort (§5.7.1.)
- le dispositif hydraulique de freinage en détente (§5.7.2.)
- le dispositif hydraulique de freinage en compression (§5.7.3.)



L - Réglage de la suspension arrière: pour adapter la réponse aux préférences du motard, on peut régler:

- la hauteur d'assiette
- la précharge du ressort (§5.8.1.)
- le dispositif hydraulique de freinage en détente (§5.8.2.)
- le dispositif hydraulique de freinage en compression pour vitesse élevée (§5.8.3.)
- le dispositif hydraulique de freinage en compression pour vitesse basse (§5.8.4.)



M - Tension de la chaîne: pour l'efficacité et la fiabilité de la transmission.



N - Orientation du phare: pour optimiser la profondeur du faisceau lumineux en fonction de l'assiette (§5.9.).



5.3. Réglage du levier de frein avant

Tirer le levier pour neutraliser la poussée du ressort et simultanément, régler la position en visant ou en dévissant l'écrou. En vissant: le levier s'éloigne de la poignée. En dévissant: le levier se rapproche de la poignée.

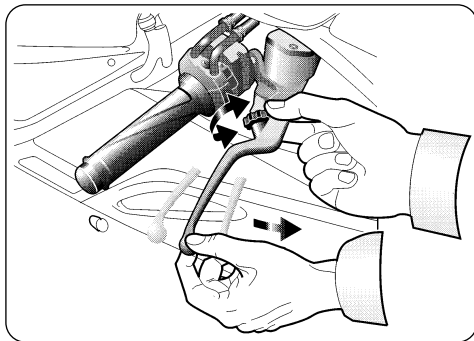

5.4. Réglage du levier d'embrayage

Tirer le levier pour neutraliser la poussée du ressort et simultanément, régler la position en visant ou en dévissant l'écrou. En vissant: le levier s'éloigne de la poignée. En dévissant: le levier se rapproche de la poignée.

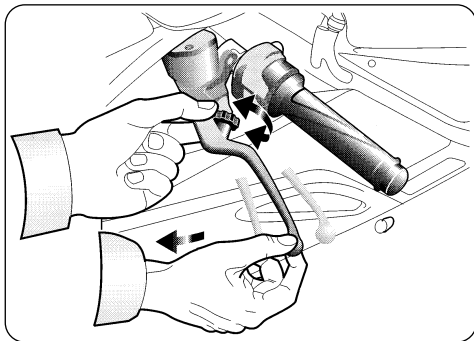



5.5. Réglage des rétroviseurs

Pousser sur les points indiqués pour orienter le rétroviseur dans les quatre directions.

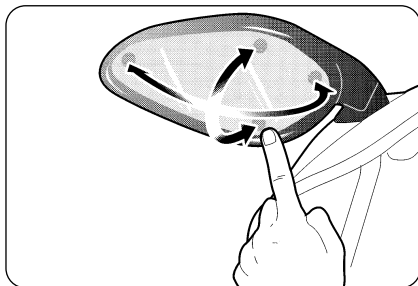

5

5.6. Réglage de l'amortisseur de direction

Le réglage standard s'obtient en dévissant le pommeau à fond, dans cette position l'amortisseur offre le minimum de résistance à l'action de la direction.

En fonction des propres impératifs de conduite, il est possible d'augmenter progressivement l'action de freinage de l'amortisseur de direction en revissant le pommeau.

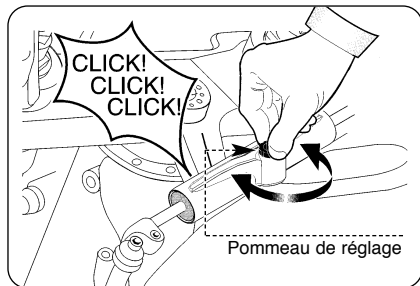



5.7. Réglage suspension avant



ATTENTION

Il est impératif que les bagues des deux tubes de fourche soient réglées sur la même position.

NOTE

L'ajustement des suspensions doit être de préférence effectué avec le réservoir de carburant plein.

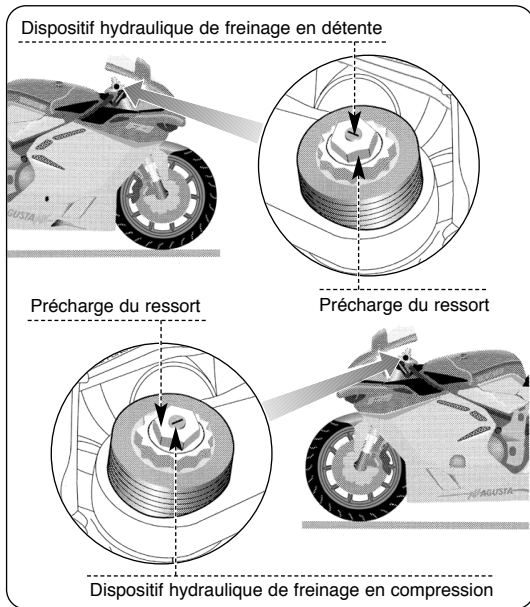



5.7.1. Précharge du ressort (suspension avant)

Le réglage s'effectue en partant de la position standard. Pour trouver cette position, il faut dévisser à fond, puis visser jusqu'à la position standard (voir tableau en annexe).

Visser pour augmenter la précharge du ressort ou dévisser pour la diminuer.

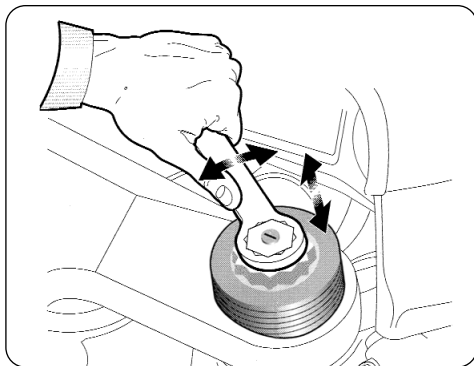

5.7.2. Dispositif hydraulique de freinage en détente (suspension avant)

Le réglage s'effectue en partant de la position standard. Pour trouver cette position, il faut visser à fond, puis dévisser jusqu'à la position standard (voir tableau).

Visser pour augmenter l'action du freinage ou dévisser pour la diminuer.

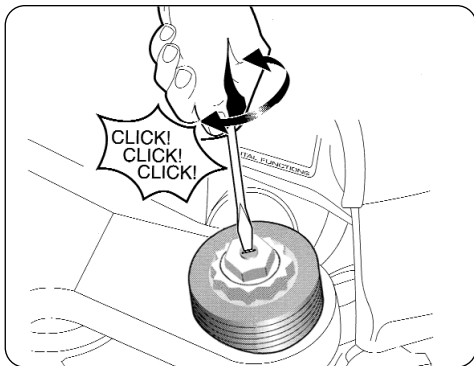



5.7.3. Dispositif hydraulique de freinage en compression (suspension avant)

Le réglage s'effectue en partant de la position standard. Pour trouver cette position, il faut visser à fond, puis dévisser jusqu'à la position standard (voir tableau).

Visser pour augmenter l'action du freinage ou dévisser pour la diminuer.

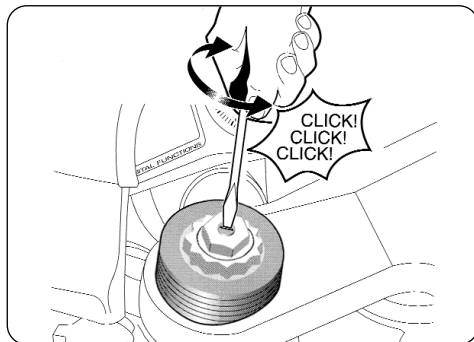



5.8. Réglage de la suspension arrière



ATTENTION: La haute température des tuyaux d'échappement peut provoquer des brûlures. Couper le moteur et attendre que les tuyaux d'échappement aient refroidi avant d'effectuer le réglage.



ATTENTION: L'amortisseur contient du gaz sous haute pression. Ne pas tenter de le démonter sous aucun prétexte.



RAPPEL: Pour évaluer le tarage de la suspension arrière, ne pas appuyer sur l'extrémité des pots d'échappement sous peine de les endommager.

NOTE: Au moment de la livraison, la suspension arrière est réglée selon la configuration standard (voir tableau en annexe).

NOTE: L'ajustement des suspensions doit être de préférence effectué avec le réservoir de carburant plein.

FR 5

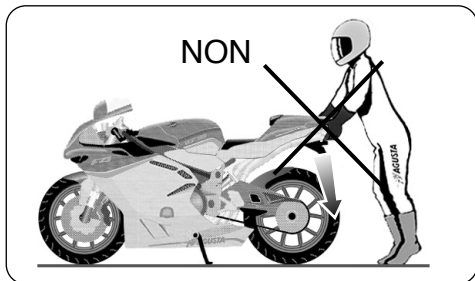
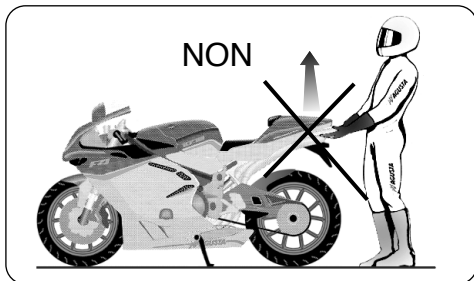



Précharge du ressort:

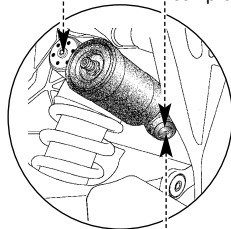

Dispositif hydraulique de freinage en compression (pour vitesse élevée)

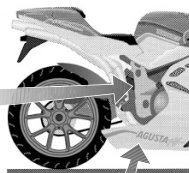

Dispositif hydraulique de freinage en compression (pour vitesse basse)

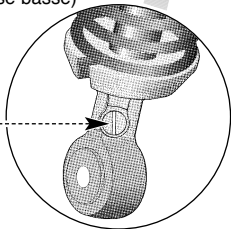

Dispositif hydraulique de freinage en détente

5.8.1. Précharge du ressort (suspension arrière)

Le réglage s'effectue en partant de la position standard. Pour trouver cette position, il faut dévisser à fond, puis visser jusqu'à la position standard (voir tableau en annexe). Visser pour augmenter la précharge du ressort ou dévisser pour la diminuer.



RAPPEL: Ne tournez pas la vis après sa position entièrement dans le sens des aiguilles d'une montre ou dans le sens contraire des aiguilles d'une montre, afin d'éviter les dommages du dispositif hydraulique.

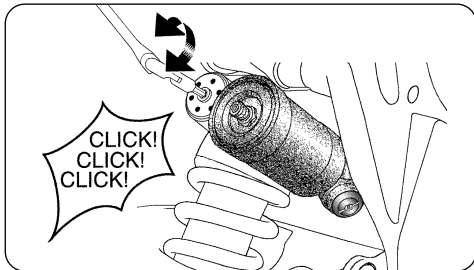



5.8.2. Dispositif hydraulique de freinage en détente (suspension arrière)

Le réglage s'effectue en partant de la position standard. Pour trouver cette position, il faut visser à fond, puis dévisser jusqu'à la position standard (voir tableau).

Visser pour augmenter l'action du freinage ou dévisser pour la diminuer.

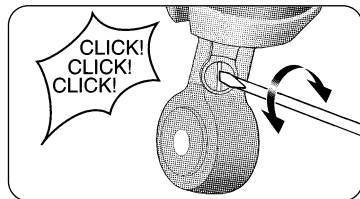

5.8.3. Dispositif hydraulique de freinage en compression pour vitesse élevée (suspension arrière)

Le réglage s'effectue en partant de la position standard. Pour trouver cette position, il faut dévisser à fond, puis visser jusqu'à la position standard (voir tableau).

Visser pour augmenter l'action du freinage ou dévisser pour la diminuer.



5.8.4. Dispositif hydraulique de freinage en compression pour vitesse basse (suspension arrière)

Le réglage s'effectue en partant de la position standard. Pour trouver cette position, il faut visser à fond, puis dévisser jusqu'à la position standard (voir tableau).

Visser pour augmenter l'action du freinage ou dévisser pour la diminuer.

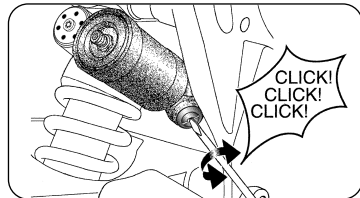



5.9. Réglage du projecteur avant

Placer le véhicule à 10 mètres d'une paroi verticale.

Veiller à ce que le terrain soit plat et l'axe du véhicule perpendiculaire à la paroi.

Le véhicule doit se trouver en position verticale. Mesurer la hauteur du centre du projecteur au sol et faire une croix sur la paroi à la même hauteur.

Allumer le code, la limite supérieure de démarcation entre la zone sombre et la zone éclairée ne doit pas dépasser $9/10$ de la hauteur au sol du centre du projecteur. Pour le réglage horizontal du phare, le champ de valeur est de $\pm 4^\circ$.

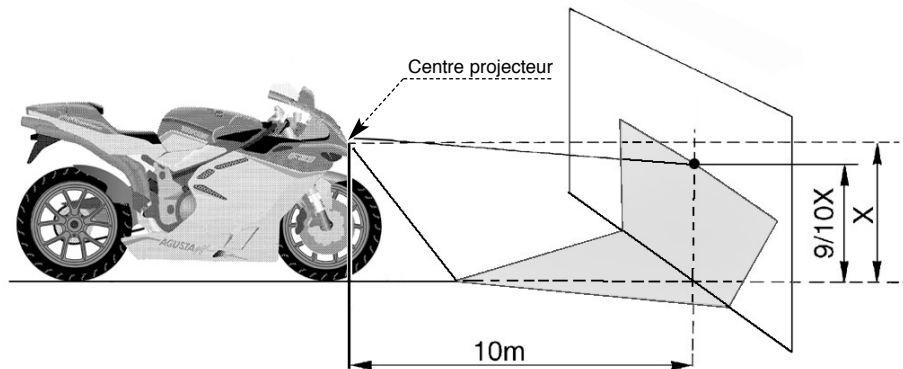



Note d'information

MV Agusta S.p.A. poursuit une politique de continuelle amélioration de ses produits. Pour cette raison, de légères différences pourraient éventuellement se présenter entre les informations de ce livret et le véhicule que vous avez acheté. Les modèles MV Agusta s'exportent dans de nombreux pays où des normes différentes sont en vigueur en ce qui concerne le Code de la Route et les procédures d'homologation. En espérant pouvoir compter sur votre compréhension, il est indispensable à MV Agusta S.p.A. de se réserver le droit d'apporter des modifications à ses produits et à la documentation technique à tout moment sans fournir de préavis.

Nous suggérons de visiter souvent le site Internet **www.mvagusta.it** afin d'obtenir des informations et des mises à jour sur les produits MV Agusta et la documentation relative.



Respectons et défendons l'environnement

Toutes nos actions ont des répercussions sur la planète entière et sur ses ressources.

MV Agusta, au profit des intérêts de tous, sensibilise les Clients et les opérateurs du service après-vente pour leur faire adopter des modalités d'utilisation du véhicule et de traitement de ses parties dans le respect des normes en vigueur en terme de pollution, traitement et recyclage des déchets.

© 2007

Toute reproduction même partielle de ce document est formellement interdite sans autorisation écrite de MV Agusta S.p.A.

Dét. n° 8000B1113

Edition n° 1 - Novembre 2007

MV AGUSTA



Bedienungsanleitung
Deutsche Version

FASTER
RIDER

Sehr geehrter Kunde,

wir danken Ihnen für das Vertrauen, dass Sie uns ausgesprochen haben und gratulieren Ihnen zur Wahl Ihres neuen F4 312.

Ihre Wahl prämiert den Einsatz unserer Techniker, die dem F4 312 funktionelle und ästhetische Merkmale gegeben haben, die dieses Fahrzeug über die besten heute verfügbaren Motorräder stellt. Damit wird es zu einem begehrten und exklusiven Fahrzeug.

Auf rein technischer Ebene repräsentiert der F4 312 mit seinen zahlreichen Innovationen einen weltweiten Bezugs- und Vergleichspunkt. Seine zeitlose, weiche und runde Linie ist ein gelungenes Zusammenspiel aus einer glanzvollen Vergangenheit und einem neuen Jahrtausend.

Die Verbindung dieser Elemente, die nur durch die Suche nach Detaillösungen, Arbeit mit Leidenschaft und dem Wunsch ein technisch und ästhetisch überlegenes Fahrzeug herzustellen, zustande kommen konnte, hebt dieses Fahrzeug aus vorübergehenden Modeerscheinungen heraus und verleiht ihm das Privileg als ein weltweit einzigartiges Objekt angesehen zu werden.

Falls Sie weitere Informationen wünschen, wenden Sie sich bitte an den Kundendienst der MV Agusta.

Viel Spaß!

*Claudio Castiglioni
Präsident
MV Agusta*



ALLGEMEINES INHALTSVERZEICHNIS

<i>Kap.</i>	<i>Inhalt</i>	<i>Seite</i>
1	ALLGEMEINE INFORMATIONEN	5
1.1.	Zweck der Bedienungsanleitung	5
1.2.	Zeichenerklärung	6
1.3.	Inhalt der CD-Rom	7
1.4.	Rahmen- und Motornummer	8
2	SICHERHEITSINFORMATIONEN	10
2.1.	Sachgemässer gebrauch des Fahrzeuges	10
2.2.	Wartung	10
2.3.	Zubehör und Änderungen	11
2.4.	Fahrzeugbeladung	11
3	BEDIENUNGSELEMENTE UND INSTRUMENTE	13
3.1.	Anbringung der Bedienungselemente und Instrumente	13
3.2.	Seitlicher Ständer	14
3.3.	Bedienungselemente links am Lenker	15
3.4.	Bedienungselemente rechts am Lenker	17
3.5.	Zündschloß und Lenkerschloß	20
3.6.	Schaltung	22
3.7.	Instrumente und Kontrolllampen	23
3.7.1.	Kontrolllampen	24
3.7.2.	Multifunktions-Display	25
3.8.	Schmiermitteltabelle	26

<i>Kap.</i>	<i>Inhalt</i>	<i>Seite</i>
4	EINSATZ	27
4.1.	Einsatz des Motorrads	27
4.2.	Einfahren	28
4.3.	Starten des Motors	30
4.4.	Auswahl und Modifizieren der Display-Funktionen	32
4.4.1.	Auswahl der Display-Funktionen	33
4.4.2.	Einstellen des Maßeinheiten	35
4.4.3.	Nullstellen der Tageskilometerzähler	38
4.4.4.	Einstellen der Uhrzeit	41
4.4.5.	Chronometer	43
4.5.	Tanken	52
4.6.	Zugang zum Staufach	53
4.7.	Parken des Motorrads	54
5	EINSTELLUNGSARBEITEN	56
5.1.	Liste der Einstellungsarbeiten	56
5.2.	Tabelle der Einstellungsarbeiten	58
5.3.	Einstellung Bremshebel Vorderradbremse	59
5.4.	Einstellung Kupplungshebel	59
5.5.	Einstellung Rückspiegel	60
5.6.	Einstellung Lenkungsdämpfer	60
5.7.	Einstellung vordere Federung	61



<i>Kap.</i>	<i>Inhalt</i>	<i>Seite</i>
5.7.1.	Federvorspannung (Vorderradfederung)	62
5.7.2.	Hydraulische Ausdehnungsbremse (Vorderradfederung)	62
5.7.3.	Hydraulische Kompressionsbremse (Vorderradfederung)	63
5.8.	Einstellung hintere Federung	64
5.8.1.	Federvorspannung (Hinterradfederung)	65
5.8.2.	Hydraulische Ausdehnungsbremse (Hinterradfederung)	66
5.8.3.	Hydraulische Kompressionsbremse für hohe Gänge (Hinterradfederung)	66
5.8.4.	Hydraulische Kompressionsbremse für niedrige Gänge (Hinterradfederung)	66
5.9.	Scheinwerfereinstellung	67



1.1. Zweck der Bedienungsanleitung

Dieses Handbuch enthält alle für einen korrekten und sicheren Gebrauch Ihres Motorrads erforderlichen Informationen.

Zusammen mit dem Handbuch erhalten Sie auch ein Quick Manual im Taschenformat mit den wichtigsten gebrauchrelevanten Informationen.

Das Handbuch wird in elektronischem Format (.pdf) auf dieser CD-Rom geliefert und kann auf jedem PC mit Windows oder Mac eingesehen oder ausgedruckt werden.

Wir bitten Sie, dieses Handbuch vor der ersten Benutzung des Motorrads aufmerksam durchzulesen und sich immer zu vergewissern, dass auch andere Personen, die das Motorrad benutzen, dies tun.

Vergessen Sie bitte nicht, in das Quick Manual Ihre Daten und die Daten Ihres Motorrads einzutragen und es immer mitzuführen.



Copyright
MV AGUSTA Motor Spa
Alle Rechte vorbehalten



1.2. Zeichenerklärung

Besonders wichtige Textstellen die sich auf die Sicherheit der Personen oder des Fahrzeugs beziehen, sind mit folgenden Symbolen gekennzeichnet:



Gefahr - Achtung: Die mangelnde oder unvollständige Beachtung dieser Vorschriften stellt eine schwere Unfallgefahr für den Arbeiter oder Dritte dar.



Vorsicht - Vorsichtsmaßnahme: Die Nichteinhaltung der Anweisungen kann schwere und dauerhafte Schäden am Fahrzeug verursachen.

Folgende Symbole werden benutzt, um anzuzeigen, wer die angegebenen Wartungs- und Einstellungsarbeiten ausführen darf:



Informationen zu Arbeiten, die vom Motorradfahrer ausgeführt werden dürfen.



Informationen zu arbeiten, die ausschließlich von ausgebildetem Fachpersonal ausgeführt werden dürfen.

Um weitere Informationen hervorzuheben, werden folgende Symbole verwendet:



Das Symbol  zeigt an, dass für die richtige Durchführung der angegebenen Arbeit ein Spezialwerkzeug oder Sonderausrüstung benötigt werden.



Das Zeichen “§” gefolgt von einer Ziffer verweist auf das entsprechende Kapitel.



1.3. Inhalt der CD-Rom

Auf der mitgelieferten CD-Rom finden Sie außer diesem Handbuch auch das Wartungshandbuch, das Quick Manual (das Sie auch als Büchlein erhalten haben), die Händlerliste und das Garantieheft.

Bei der Übergabe des Motorrades hat Ihnen Ihr Händler auch das Garantiebescheinigung ausgehändigt.

Bewahren Sie es bitte sorgfältig zusammen mit den Fahrzeugpapieren und den zukünftigen Bescheinigungen auf, die Sie bei jeder Inspektion ausgehändigt bekommen werden.

WICHTIG

Eine Kopie der Garantiebescheinigung muß vom Vertragshändler ausgefüllt und innerhalb von 10 Tagen nach Zulassung an die MV Agusta geschickt werden.

Die Wartungscoupons müssen nach Abschluss der jeweiligen Wartungsarbeiten ebenfalls innerhalb von 10 Tagen vom Vertragshändler ausgefüllt und an die MV Agusta geschickt werden.

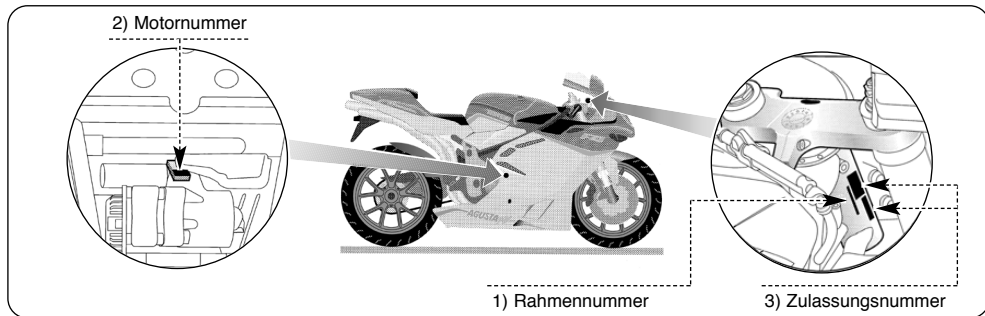

1.4. Rahmen- und Motornummer

- 1) Rahmennummer
- 2) Motornummer
- 3) Zulassungsnummer

► Kennzeichnung des Motorrads

Das Motorrad wird durch die Rahmennummer eindeutig gekennzeichnet. Bei Ersatzteilbestellungen müssen die Rahmennummer und gegebenenfalls auch die Motornummer, die Farbkennziffer und die Schlüsselnummer angegeben werden.

Wir empfehlen Ihnen die wichtigsten Angaben nachstehend einzutragen.

RAHMENNUMMER: _____

MOTORNUMMER: _____



► Schlüsselnummer

Sie erhalten einen Schlüssel und einen Ersatzschlüssel. Die Schlüssel dienen als Zündschlüssel und zum Öffnen aller Schlösser. Den Ersatzschlüssel an einem sicheren Ort aufbewahren.

Bei Nachfrage eines Duplikates ist die Kenntnis der Identifikationsnummer des Schlüssels grundlegend. Tragen Sie Ihre Schlüsselnummer hier ein:

SCHLÜSSELNUMMER: _____

► Farbkennziffer

Die Farbkennziffer wird bei Bestellung von Karosserieteilen benötigt. Diese Kennziffer kann am Schild an der Innenseite des Heckteils abgelesen werden.

Es wird geraten, die Farbkennziffer des Motorrads im nachfolgenden Leerraum einzutragen:

FARBKENNZIFFER: _____

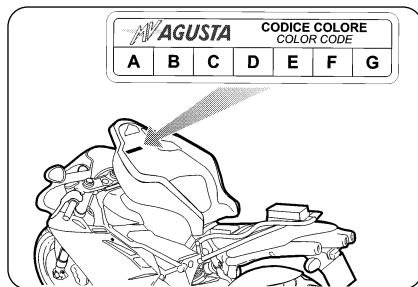
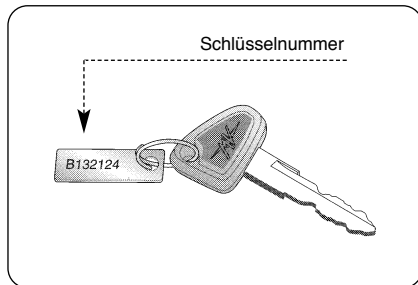



2.1. SACHGEMÄSSER GEBRAUCH DES FAHRZEUGES

Ihr Motorrad wurde ausschließlich für die Benutzung auf Straßen und Autobahnen geplant.



ACHTUNG

Ausnahmeweise können Sie Ihr Motorrad auch auf einer Rennstrecke benutzen – allerdings nicht, um Rennen zu fahren.

Dabei ist das Motorrad jedoch sehr hohen Beanspruchungen ausgesetzt und daher sollte es vorher und nachher in einer MV Agusta-Vertragswerkstatt überprüft werden.

Jeder andere Einsatz ist ausdrücklich ausgeschlossen und strengstens untersagt.

Weitere Informationen zur Benutzung des Motorrades finden Sie im Abschnitt 4 dieses Handbuches.

2.2. WARTUNG

Damit Ihr Motorrad stets einwandfrei und zuverlässig funktioniert, müssen Sie die im Wartungshandbuch vorgesehenen Inspektionstermine unbedingt einhalten.

Sie sollten diese ausschließlich von Fachleuten in einer MV Agusta-Vertragswerkstatt durchführen lassen.

Sollten Sie sich hingegen für eine freie Werkstatt entscheiden, müssen Sie sich von dieser bestätigen lassen, dass sie über alle für die Durchführung der erforderlichen Kontrollen und Einstellungen notwendigen Ausrüstungen, Möglichkeiten und Kenntnisse verfügt.



ACHTUNG

Die Garantie von MV Agusta könnte im Fall von in freien Werkstätten ausgeführten Eingriffen an Ihrem Motorrad, die nicht den technischen Rundschreiben und den MV Agusta-Werkstatthandbüchern entsprechen, verfallen.

**2.3. ZUBEHÖR UND ÄNDERUNGEN****ACHTUNG**

Der Hersteller untersagt jegliche eigenmächtige Änderung an seinen Fahrzeugen.

Nur so kann die Sicherheit der Benutzer gewährleistet werden.

Allerdings besteht die Möglichkeit, Ihr Motorrad anhand des umfangreichen MV Agusta-Zubehörkatalogs zu personalisieren.

**ACHTUNG**

Durch die Installation einiger dieser Zubehörteile kann die Zulassung des Motorrades jedoch ungültig werden, was bedeutet, dass Sie damit nicht mehr auf öffentlichen Straßen fahren dürfen.

Wenden Sie sich daher im Zweifelsfall an Ihren Vertragshändler MV Agusta, bevor Sie entscheiden, welches Zubehör für Ihre Erfordernisse geeignet ist.

2.4. FAHRZEUGBELADUNG

Die Fahrzeugmodelle **F4 1078 RR 312** und **F4 1000 R 312** sind für einen Einsatz ausschließlich mit Fahrer entwickelt worden. Die Modelle **F4 1078 RR 1+1 312** und **F4 1000 R 1+1 312** hingegen sind für einen Einsatz mit Fahrer und Beifahrer vorgesehen. Für einen sicheren Einsatz und unter Beachtung der Straßenverkehrsordnung darf das zulässige Gesamtgewicht des Fahrzeugs nie überschritten werden. Nachstehend die Gewichtsangaben:

F4 1078 RR 312 / F4 1000 R 312

Maximales Gesamtgewicht	340 kg
Maximallastgewicht	110 kg

F4 1078 RR 1+1 312 / F4 1000 R 1+1 312

Maximales Gesamtgewicht	420 kg
Maximallastgewicht	180 kg



Das maximale Gesamtgewicht ist die Summe der folgenden Gewichte, gemäß der Richtlinien CEE 92/61:

- Motorradgewicht;
- Fahrergewicht;
- Beifahrgewicht (nur bei Modelle F4 1078 RR 1+1 312 und F4 1000 R 1+1 312);
- Ladegewicht und das der Zubehörteile.

**ACHTUNG**

Da das Gewicht einen enormen Einfluss auf die Lenkbarkeit, die Bremsleistung, die Fahrzeugeigenschaften und die Fahrzeugsicherheit hat, müssen die folgenden Vorschriften stets eingehalten werden.

- **DAS MOTORRAD NIE ÜBERLADEN!** Ein überladenes Motorrad kann die Reifen beschädigen, zu einem Kontrollverlust und schweren Unfällen führen. Überprüfen, dass das Gesamtgewicht mit Fahrer, Beifahrer, Gepäck und Zubehör das zulässige Fahrzeug-Gesamtgewicht nicht überschreitet.



3.1. Anbringung der Bedienungselemente und Instrumente

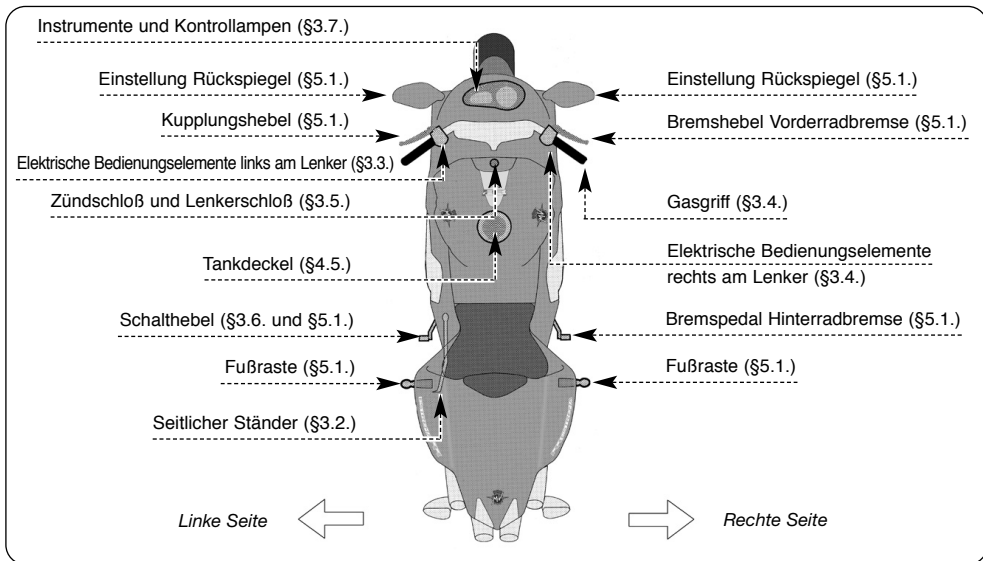



3.2. Seitlicher Ständer

Der Seitenständer ist mit einem Sicherheitsschalter (Startfreigabe) ausgerüstet, der ein Losfahren bei runtergeklapptem Seitenständer verhindert.

Ist der Motor bei runtergeklapptem Seitenständer angelassen worden und wird der Kupplungshebel gezogen, um zu Losfahren einen Gang einzulegen, wird die Stromversorgung zum Motor unterbrochen und der Motor stellt sich ab.

Ist der Seitenständer runtergeklappt und gleichzeitig ein Gang eingelegt, verhindert der Schutzschalter, dass der Motor gestartet werden kann. Auf diese Weise wird ein Umfallen des Motorrads vermieden.

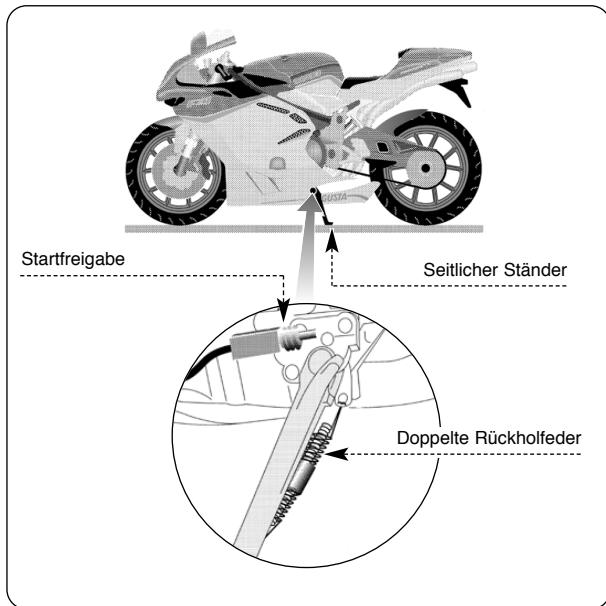



3.3. Bedienungselemente links am Lenker

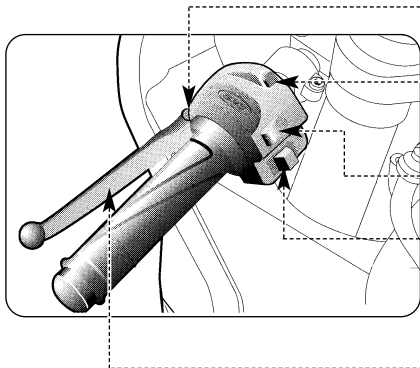

Druckschalter Lichtupe

Den Schalter mehrmals drücken

Druckschalter Fernlicht/Fahrlicht

Druckschalter hoch ■ : Fahrlicht 

Druckschalter tief ▬ : Fernlicht 

Hupenschalter

Zur Betätigung der Hupe den Schalter drücken.

Blinkerschalter

Bei Verstellen des Hebels nach rechts oder links werden jeweils die rechten oder linken Blinker eingeschaltet. Der Hebel stellt sich auf Mittelstellung zurück. Zum Ausschalten der Blinker auf den Hebel drücken.

Kupplungshebel

Zur Betätigung der Kupplung den Kupplungshebel ziehen und wieder loslassen.



Lichthupenschalter

Die Betätigung der Lichthupe durch den Lichthupenschalter dient dazu andere Verkehrsteilnehmer auf sich aufmerksam zu machen oder Gefahren zu signalisieren. Bei eingeschaltetem Fernlicht funktioniert die Lichthupe nicht.

Druckschalter Fernlicht/ Abblendlicht

Schaltet sich normalerweise das Abblendlicht ein. Wenn es der Verkehr und die Straßenführung zulassen, kann mit diesem Druckschalter auf Fernlicht umgeschaltet werden.

Hupenschalter

Die Betätigung der Hupe durch den Hupenschalter dient dazu andere Verkehrsteilnehmer auf sich aufmerksam zu machen oder Gefahren zu signalisieren.

Blinkerschalter

Mit diesem Schalter kann anderen Verkehrsteilnehmern ein Fahrtrichtungs- oder Spurwechsel angezeigt werden.



ACHTUNG

Das Nichtbetätigen oder die falsche Betätigung/ das Nichtausschalten des Blinkerschalters kann Unfälle verursachen. Die anderen Verkehrsteilnehmer können dadurch falsche Rückschlüsse auf die tatsächliche Fahrtrichtung ziehen. Vorm Abbiegen oder Spurwechsel stets die Blinker betätigen.

Kupplungshebel

Mit diesem Hebel wird die Kupplung über eine hydraulische Vorrichtung ein- und ausgekuppelt.



3.4. Bedienungselemente rechts am Lenker

Schalter zum Abstellen des Motors

Bei Betätigung wird der Motor abgestellt und kann nicht gestartet werden.

Druckschalter zum Anlassen des Motors

Bei Betätigung wird der Motor gestartet. Sobald der Motor läuft muß der Schalter losgelassen werden. Wird der Schalter bei laufendem Motor erneut betätigt, können die Display-Funktionen ausgewählt werden.

Chokehebel (Kaltstart)

Bei Kaltstart des Motors in Uhrzeigersinn drehen. Nach einigen Sekunden den Hebel in Ausgangsstellung zurückstellen.

Gasgriff

Zum Gasgeben den Griff drehen.

Bremshebel Vorderradbremse

Zum Bremsen mit der Vorderradbremse den Bremshebel ziehen.

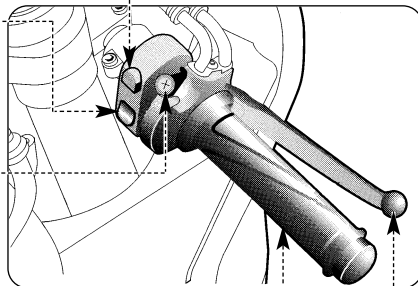



Schalter zum Abstellen des Motors

Mit diesem Schalter kann der Motor in Notfällen abgestellt werden. Wird dieser Schalter betätigt, wird der Zündkreislauf unterbrochen, der Motor kann nicht gestartet werden. Soll der Motor neu gestartet werden, muss vorher dieser Schalter in Ausgangsstellung zurückgestellt werden.

ANMERKUNG

Unter normalen Bedingungen wird dieser Schalter nie zum Abstellen des Motors verwendet.

Druckschalter zum Anlassen des Motors

Mit diesem Schalter wird der Motor gestartet. Bei laufendem Motor können über diesen Schalter die einzelnen Display-Funktionen ausgewählt werden.



VORSICHT

Um Schäden an der elektrischen Anlage zu vermeiden, sollte dieser Schalter bei Startversuchen nie länger als 5 Sekunden gedrückt werden.

Sprint der Motor nach einigen Startversuchen nicht an, siehe Kapitel "STÖRUNGEN" in der vorliegenden Bedienungsanleitung.

Chokehebel (Kaltstart)

Mit dieser Vorrichtung wird der Kaltstart des Motors vereinfacht.

ANMERKUNG

Der Chokehebel sollte nur kurze Zeit und bei der entsprechenden Motor- und Außentemperatur gezogen werden. Reicht die Motordrehzahl aus, um den Motor im Leerlauf laufen zu lassen, sollte der Chokehebel zurückgestellt werden.



Gasgriff

Mit dem Gasgriff wird die Benzinversorgung des Motors geregelt. Zum Gasgeben den Gasgriff aus Ruhestellung (Leerlaufstellung) drehen.

Wird nach einem Kaltstart des Motors (eingeschalteter Choke) der Gasgriff wiederholt in Ruhestellung zurückgedreht, wird der Chokehebel in Ausgangsstellung zurückgestellt.

Bremshebel der Vorderradbremse

Diese Steuerung ermöglicht die Einschaltung des Vorderrad-Bremssystems durch einen hydraulischen Kreislauf.



3.5. Zündschloß und Lenkerschloß



ACHTUNG

Keine Schlüsselanhänger oder anderes am Zündschlüssel anbringen, damit die Lenkerdrehung nicht eingeschränkt wird.



ACHTUNG

Den Zündschlüssel niemals während der Fahrt drehen, Sie könnten sonst die Kontrolle über das Fahrzeug verlieren.

Über das Zündschloß werden der elektrische Kreislauf und das Lenkerschloß ein- bzw. ausgeschaltet. Es gibt folgende vier Stellungen für den Zündschlüssel:

Stellung "OFF"

Alle elektrischen Stromkreise sind ausgeschaltet, der Zündschlüssel kann abgezogen werden.

Stellung "ON"

Alle elektrischen Stromkreise sind eingeschaltet, die Instrumente und Kontrolllampen führen eine Autodiagnose durch, der Motor kann gestartet werden. Der Zündschlüssel kann nicht abgezogen werden.

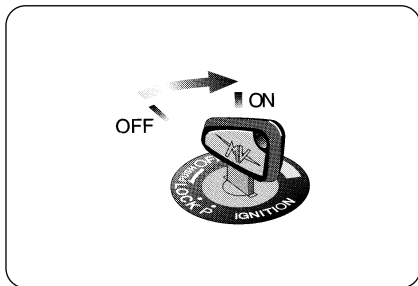

VORSICHT

Um Schäden an den elektrischen Bauteilen des Motorrades zu vermeiden, bei ausgeschaltetem Motor den Zündschlüssel nicht über längere Zeit auf Stellung "ON" lassen.



Stellung "LOCK"

Den Lenker nach rechts oder links drehen. Den Schlüssel leicht drücken und auf Stellung "LOCK" drehen.

Alle elektrischen Stromkreise sind ausgeschaltet, das Lenkerschloß ist eingerastet, der Zündschlüssel kann abgezogen werden.

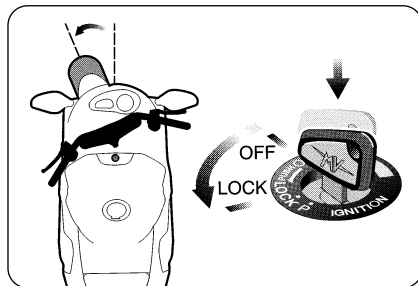

3 DE

Stellung "P"

Den Schlüssel von Stellung "LOCK" auf Stellung "P" drehen. Alle elektrischen Stromkreise sind mit Ausnahme des Parklichts (Standlichts) ausgeschaltet, das Lenkerschloß ist eingerastet. Der Zündschlüssel kann abgezogen werden.



VORSICHT

Um ein Entladen der Motorradbatterie zu vermeiden, den Schlüssel nicht längere Zeit in Stellung "P" lassen.

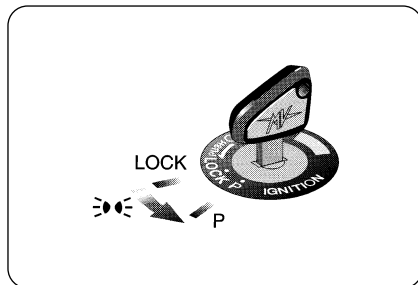



3.6. Schaltung

Die Stellung **N** "Neutral" ist die Leerlaufstellung, die auch durch Aufleuchten der entsprechenden Kontrolllampe am Armaturenbrett angezeigt wird.

Durch Drücken nach unten wird der erste Gang eingelegt.

Durch Drücken nach oben wird der zweite Gang, durch weiteres Drücken der dritte Gang usw. bis zum sechsten Gang eingelegt.

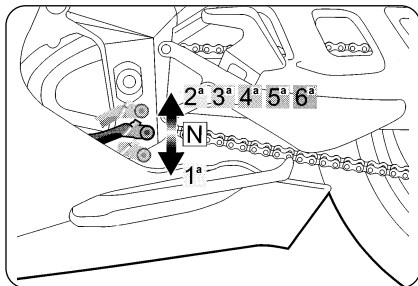



3.7. Instrumente und Kontrolllampen

Die Instrumente und Kontrolllampen werden durch Drehen des Zündschlüssels auf "ON" eingeschaltet. Nach einer ersten Überprüfung (ungefähr 7 Sekunden) zeigen die Instrumente den allgemeinen Zustand des Motorrads in diesem Moment an.

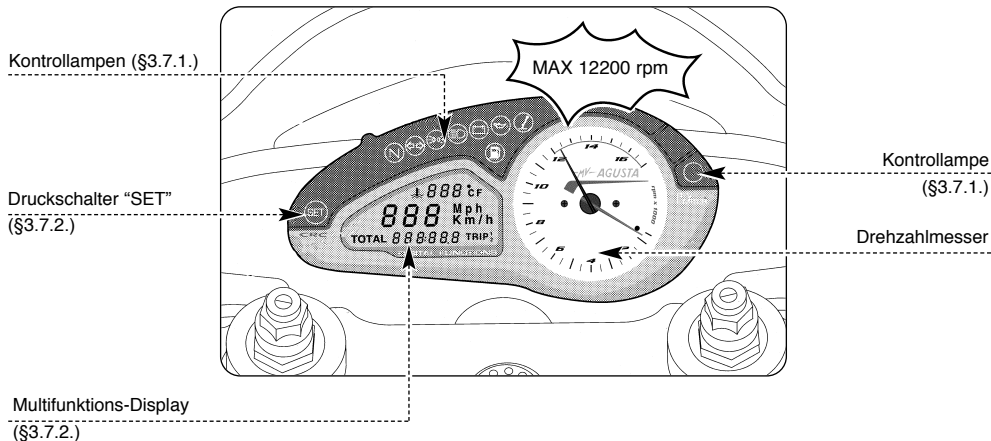



3.7.1. Kontrollampen

Fernlichtkontrolle (blau)

Leuchtet auf, wenn das Fernlicht eingeschaltet ist.

Kontrollampe Fahrlicht (grün)

Leuchtet auf, wenn Fahrlicht eingeschaltet sind.

Kontrollampe Leerlauf (grün)

Leuchtet auf, wenn sich der Schalthebel in Leerlaufstellung "Neutral" befindet.

Blinkerkontrolle (grün)

Leuchtet auf, wenn die Blinker eingeschaltet sind.

Benzinreserve (orange)

Leuchtet auf, wenn die 4-Liter Reserve im Tank erreicht ist.

Batterieladekontrolle (rot)

Leuchtet auf, wenn die Lichtmaschine nicht ausreichend Strom zum Laden der Batterie liefert.

Leuchtet die Batterieladekontrolle während der Fahrt auf, wenden Sie sich bitte an einen Kundendienst.

Kontrolle ausgeklappter Seitenständer (rot)

Leuchtet auf, wenn der Seitenständer ausgeklappt ist.

Kontrollampe Drehzahlbegrenzung (rot)

Leuchtet auf, wenn die Motordrehzahl über 12200 U/min liegt. Die Drehzahlbegrenzung schaltet sich ab 13000 U/min ein.

Kontrollampe Motoröldruck (rot)

Leuchtet bei unzureichendem Motoröldruck auf.



Gefahr - Achtung: Wenn diese Kontrollampe während der Fahrt aufleuchtet, sofort anhalten, den Motorölstand überprüfen und läß durch eine MV Agusta-Kundendienst Motoröl nachfüllen (siehe §3.8.). Leuchtet die Kontrollampe trotz ausreichendem Motorölstand weiterhin auf, nicht weiterfahren und einen MV Agusta-Kundendienst rufen.

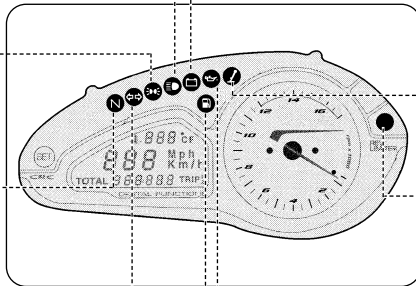



3.7.2. Multifunktions-Display

Tachometer

Zeigt die Geschwindigkeit an. Die Geschwindigkeit kann in Kilometer pro Stunde (km/h) oder Meilen pro Stunde (Mph) angezeigt werden. Die Tachometerskala reicht bis 350 km/h (218 Mph).

Druckschalter "SET"

Durch Drücken können die Ziffern am Display eingestellt werden. Durch erneutes Drücken wird die Eingabe bestätigt.

Wenn dieser Schalter zusammen mit dem Anlasserschalter gedrückt wird, wird die Chronometer-Funktion eingeschaltet.

Kilometerzähler "TOTAL"

Zeigt die gesamten gefahrenen Kilometer an; von 0 bis 99999,9 (km oder mile)

Tageskilometerzähler "TRIP 1"

Zeigt die gefahrenen Kilometer einer Teilstrecke an; von 0 bis 9999,9 (km oder mile)

Tageskilometerzähler "TRIP 2"

Zeigt die gefahrenen Kilometer einer Teilstrecke an; von 0 bis 9999,9 (km oder mile)

Uhr - Zeigt die Uhrzeit an (0 - 24)

Thermometer

Zeigt die Temperatur der Kühlflüssigkeit an. Die Temperatur kann in °C oder in °F angezeigt werden.

Der Anzeigebereich liegt zwischen 40° und 140°C (104° und 284°F):

- Temperaturen unter 40°C (104°F) werden nicht angezeigt, es erscheinen drei blinkende Linien, die niedrige Temperatur anzeigen.
- Zwischen 40° und 49° C (104° und 120° F) blinkt die Anzeige, das ist die Warnung vor niedriger Temperatur.
- Zwischen 50° und 111°C (122° und 232°F) ist die Anzeige konstant.
- Zwischen 112° und 140°C (234° und 284°F) blinkt die Anzeige, das ist die Warnung vor hoher Temperatur.

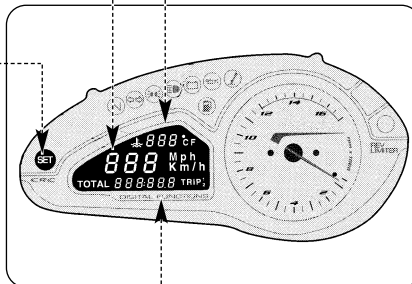

Gefahr - Achtung: Bei Temperaturen von mehr als 120°C (248°F) das Motorrad anhalten, den Motor abstellen und den Kühlflüssigkeitsstand überprüfen. Muss Kühlflüssigkeit nachgefüllt werden, den MV Agusta-Kundendienst benachrichtigen (siehe §3.8.). Leuchtet die Anzeige trotz richtigem Kühlflüssigkeitsstand auf, nicht weiterfahren und einen MV Agusta-Kundendienst rufen.



3.8. Schmiermitteltabelle

Beschreibung	Empfohlenes Produkt	Technische Angaben
Motoröl	AGIP RACING 4T 10W/60 (*)	SAE 10W/60 - API SJ
Kühlflüssigkeit	AGIP ECO - PERMANENT	Glykolethylen mit 50% destilliertem Wasser verdünnt
Brems- und Kupplungsflüssigkeit	AGIP BRAKE FLUID DOT4	DOT4
Kettenöl	MOTUL CHAIN LUBE ROAD	-

* : Damit Sie die empfohlenen Produkte finden und kaufen können, empfiehlt Ihnen MV Agusta sich direkt an die autorisierten Vertragshändler zu wenden. Das Motoröl AGIP Racing 4T 10W/60 wurde speziell für den Motor des Motorrads F4 entwickelt. Steht das empfohlene Schmiermittel nicht zu Verfügung, rät MV Agusta zum Gebrauch vollständig synthetischer Öle, die die gleichen oder bessere Eigenschaften als folgende Normen haben:

- Konform API SJ
- Konform ACEA A3
- Konform JASO MA
- Grad SAE 20 W-50 o 10 W-60

ANMERKUNG

Die o. a. Spezifizierungen müssen entweder allein oder zusammen mit anderen auf dem Behälter des Motoröl aufgedruckt sein.





4.1. Einsatz des Motorrads

In diesem Abschnitt werden die wichtigsten Themen für einen richtigen Einsatz des Motorrades behandelt.



ACHTUNG

Das Motorrad zeigt hohe Leistungsmerkmale. Für sein Gebrauch wird ein ausreichendes Niveau des Wissens des Fahrzeugs angefordert. Wenn Sie dieses Motorrad zum ersten Mal benutzen, ist es notwendig, eine vorsichtige Haltung anzunehmen. Eine konkurrenzfähige Ridinghaltung kann die Gefahr der Unfälle erhöhen, welche die Sicherheit des Treibers und der Leute gefährden.



ACHTUNG

DIE BESCHRÄNKUNGEN FÜR DIE ERLAUBTE NUTZUNG DES FAHRZEUGES FINDEN SIE IM ABSCHNITT "SICHERHEITSINFORMATIONEN".



VORSICHT

Die hohen Temperaturen, die durch den Gebrauch auf Rennstrecken verursacht wurden, konnten die Leistungsfähigkeit des katalytischen Konverters und der Abgasanlage verringern; folglich schlagen wir das Zusammenbauen einer speziellen Abgasanlage vor, wenn Sie den Fahrzeug auf Rennstrecken benutzen.



4.2. Einfahren



Vorsicht - Vorsichtsmaßnahme: Die Nichteinhaltung der Anweisungen kann schwere und dauerhafte Schäden am Fahrzeug verursachen.

Normalerweise denkt man beim Einfahren nur an den Motor. Tatsächlich muß die Einfahrzeit auch für andere wichtige Motorradteile berücksichtigt werden. Dies gilt besonders für die Reifen, die Bremsen, die Antriebskette usw. Die ersten Kilometer müssen besonders langsam und ruhig gefahren werden.

Von 0 bis 500 km (von 0 bis 300 mile) (A)

In dieser ersten Einfahrphase sollte die Motordrehzahl häufig geändert werden. Möglichst auf leicht hügeligen und kurvenreichen Strecken fahren und lange grade Strecken vermeiden.

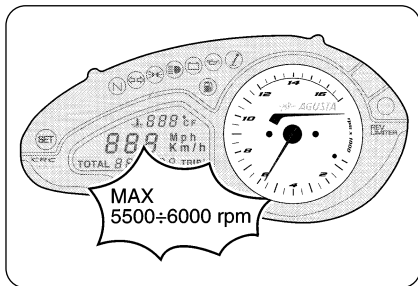

ACHTUNG

Neue Reifen müssen auf geeignete Weise eingefahren werden, so dass sie ihre komplette Effizienz erhalten. Während der ersten 100 km sollte ein Anfahren bei Vollgas, schnelle Kurvenfahrten und Vollbremsungen vermieden werden. Wird der Einfahrzeitraum nicht beachtet, besteht Schleuder- oder Unfallgefahr, weil die Kontrolle über das Fahrzeug verloren gehen kann.



☐ **Von 500 bis 1000 km (von 300 bis 600 mile)**

In dieser Phase Vollgas vermeiden und nie über lange Strecken mit konstanter Geschwindigkeit fahren.

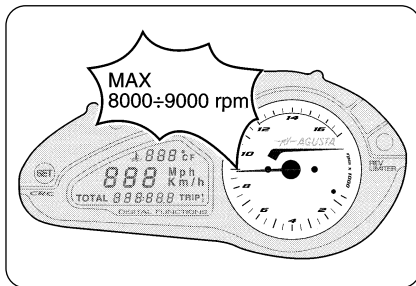

☐ **Von 1000 bis 2500 km (von 600 bis 1600 mile)**

Das Motorrad kann jetzt stärker beansprucht werden. Trotzdem sollte die angegebene Motordrehzahl nicht überschritten werden.

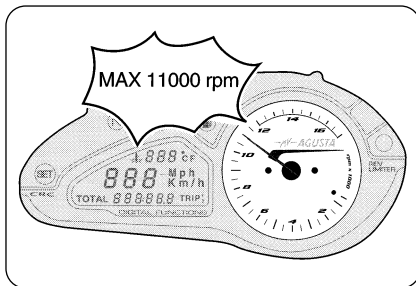



4.3. Starten des Motors



ACHTUNG

Niemals den Motor in geschlossenen Räumen laufen lassen. Vergiftungsgefahr! Die Abgase enthalten Kohlenmonoxyd, ein farb- und geruchloses Gas, dessen Einatmen zu schweren Vergiftungen oder zum Tod führen kann. Den Motor nur im Freien laufen lassen.

► Wird der Zündschlüssel auf "ON" gedreht, führen die Instrumente und Kontrolllampen eine Autodiagnose durch. Überprüfen Sie während dieser Phase, dass alle Kontrolllampen am Armaturenbrett aufleuchten. Damit der Zündkreislauf-Unterbrechungssystem den Start freigibt, muss einer der folgenden Voraussetzungen erfüllt sein:

- Der Schalthebel muss auf Leerlaufstellung stehen.
- Ein Gang ist eingelegt, gleichzeitig ist der Kupplungshebel gezogen, der Seitenständer ist hochgeklappt.

☐ Kaltstart

► Den "CHOKE" Hebel drehen, ohne dabei den Gasgriff zu drehen, und den Anlasserschalter drücken.

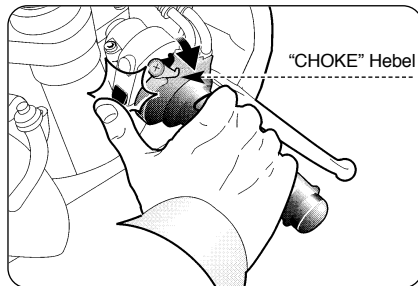



► Sobald der Motor angesprungen ist, den Anlasserschalter loslassen. Nach kurzem Warmlaufen des Motors den "CHOKE" Hebel in Ausgangsstellung zurückstellen.

☐ **Warmstart**

- Den Anlasserschalter drücken, ohne dabei den Gasgriff zu drehen.
► Sobald der Motor gestartet ist, den Anlasserschalter loslassen.



Vorsicht – Vorsichtsmassnahme

- Um Schäden an der Elektroanlage zu vermeiden, den Anlasserschalter nie länger als 5 Sekunden gedrückt halten.
- Den Motor nicht lange im Stand laufen lassen. Der Motor kann sich dabei überhitzen und Motorbauteile beschädigen. Der Motor sollte durch langsames Fahren auf Betriebstemperatur gebracht werden.
- Bei kaltem Motor kein Vollgas geben, der Motor hält dann wesentlich länger.

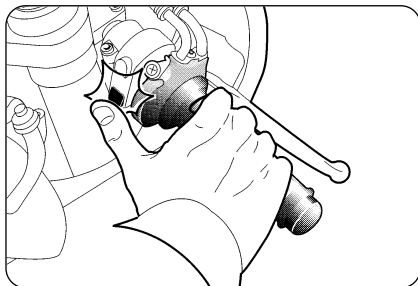



4.4. Auswahl und Modifizieren der Display-Funktionen

Am Instrument können einige wichtige Messparameter geändert und die Chronometerfunktion eingestellt werden. Folgendes kann eingestellt bzw. ausgewählt werden:

- Auswahl folgender Funktionen:

Kilometerzähler	Gesamtkilometer	“TOTAL”
Kilometerzähler	Tageskilometer 1	“TRIP 1”
Kilometerzähler	Tageskilometer 2	“TRIP 2”
Uhrzeit		
Chronometer		

- Maßeinheiten können eingestellt werden für:

Geschwindigkeit
Fahrstrecke
Temperatur

- Nullstellen der Tageskilometeranzeige:

Kilometerzähler	Tageskilometer 1	“TRIP 1”
Kilometerzähler	Tageskilometer 2	“TRIP 2”

- Einstellen der Uhrzeit

- Einschalten des Chronometers

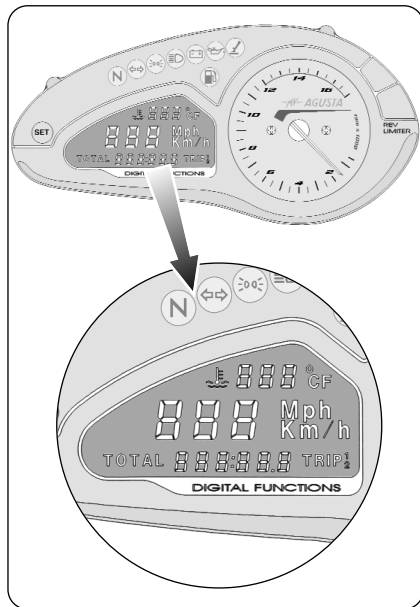



4.4.1. Auswahl der Display-Funktionen

Die Auswahl betrifft die Funktionen des:

- Kilometerzähler Gesamtkilometer "TOTAL"
- Kilometerzähler Tageskilometer 1 "TRIP 1"
- Kilometerzähler Tageskilometer 2 "TRIP 2"
- Uhrzeit
- Chronometer

► Durch Drücken des Anlasserschalters werden nacheinander die Funktionen "TOTAL", "TRIP1" und "TRIP2" angezeigt. Die gewünschte Anzeige auswählen.

► Die Anzeige der Chronometerfunktion wird auf der nächsten Seite beschrieben.

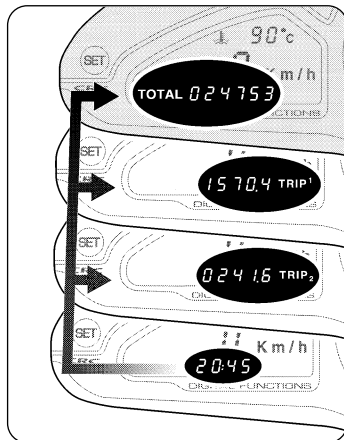
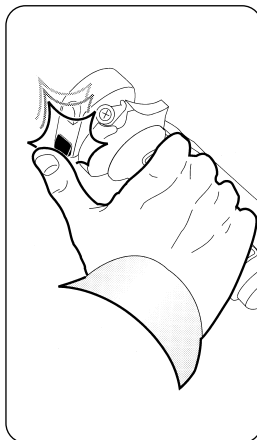

4



ACHTUNG

Änderungen oder Einstellung der Display-Funktionen müssen bei laufendem Motor, eingelegtem Leerlauf, angehaltenem Motorrad und beiden Füßen auf der Erde vorgenommen werden. Einstellungen am Display während der Fahrt zu ändern ist verboten.



□ Chronometer

► Der Chronometer kann nur eingeschaltet werden, wenn eine der folgenden Funktionen am Display angezeigt werden:

- Kilometerzähler Gesamtkilometer "TOTAL"
- Kilometerzähler Tageskilometer 1 "TRIP 1"
- Kilometerzähler Tageskilometer 2 "TRIP 2"
- Uhrzeit

► Für länger als 2 Sekunden gleichzeitig den Schalter "SET" und den Anlasserschalter drücken.

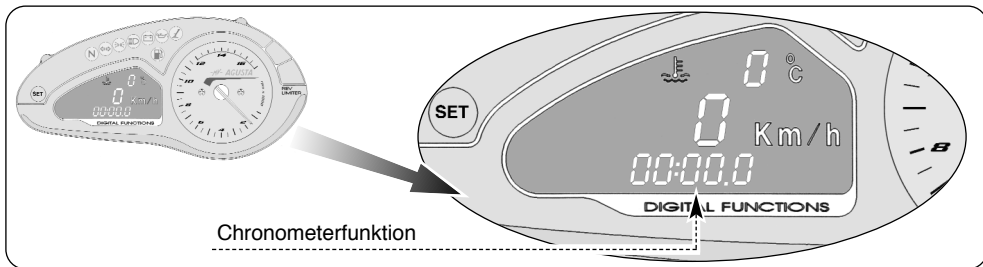
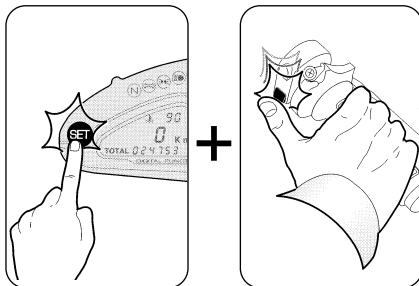

Die Chronometerfunktion wird auf den nächsten Seiten beschrieben (§ 4.4.5).



4.4.2. Einstellen des Maßeinheiten

Es besteht die Möglichkeit die Maßeinheiten zu ändern.



ACHTUNG

Änderungen oder Einstellung der Display-Funktionen müssen bei laufendem Motor, eingelegetem Leerlauf, angehaltenem Motorrad und beiden Füßen auf der Erde vorgenommen werden. Einstellungen am Display während der Fahrt zu ändern ist verboten.

□ Tachometer (km/h - Mph)

- ▶ Den Anlasserschalter mehrfach drücken, bis der Gesamt-Kilometerzähler "TOTAL" angezeigt wird.
- ▶ Den Druckschalter "SET" drücken, die Maßeinheit des Tachometers beginnt zu blinken.

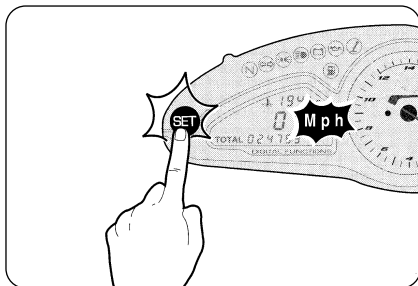
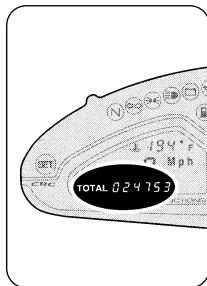
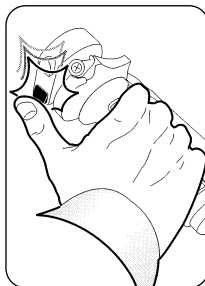



► Den Anlasserschalter drücken, um von km/h auf Mph oder umgekehrt umzuschalten. Wird die Maßeinheit am Tachometer verändert, ändert sich automatisch auch die Maßeinheit am Kilometerzähler (Gesamtkilometer und Tageskilometer).

Beachten: 1 mi = 1,609 km

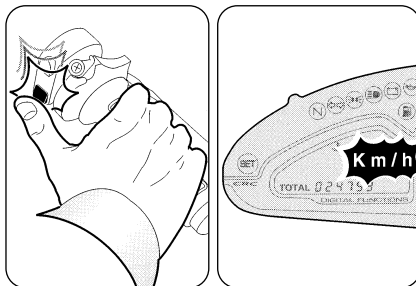

► Den Druckschalter "SET" zur Bestätigung der Änderung der Maßeinheit am Tachometer drücken. Anschließend beginnt die Maßeinheit der Temperaturanzeige zu blinken. Jetzt kann die nächste Änderung vorgenommen werden.

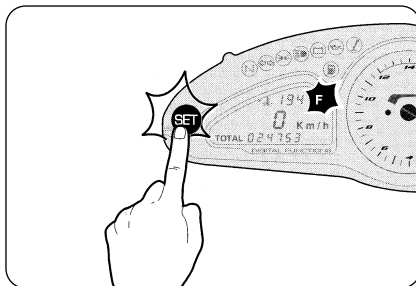

DE 4



□ Thermometer (° C - ° F)

► Den Anlasserschalter drücken, um von °C auf °F oder umgekehrt umzuschalten.

Beachten: $T (^{\circ}\text{F}) = 1,8 \cdot t (^{\circ}\text{C}) + 32$

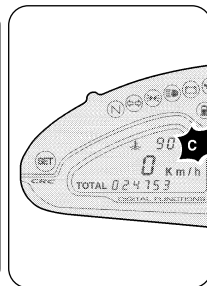
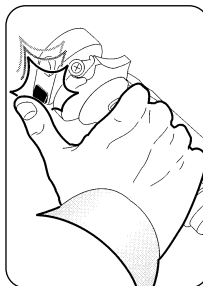

► Den Druckschalter "SET" zur Bestätigung der Änderung der Maßeinheit am Thermometer drücken.

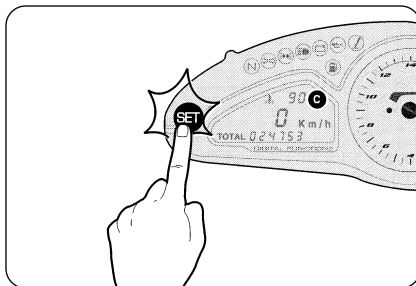



4.4.3. Nullstellen der Tageskilometerzähler

Die Anzeigen des Tageskilometerzählers "TRIP1" und des Tageskilometerzählers "TRIP2" können folgendermaßen auf Null zurückgestellt werden.



ACHTUNG

Änderungen oder Einstellung der Display-Funktionen müssen bei laufendem Motor, eingelegetem Leerlauf, angehaltenem Motorrad und beiden Füßen auf der Erde vorgenommen werden. Einstellungen am Display während der Fahrt zu ändern ist verboten.

► Durch Drücken des Anlasserschalters können die Funktionen "TRIP1" eingeschaltet werden.

► Wird der Anlasserschalter länger als 4 Sekunden gedrückt gehalten; der Wert "TRIP 1" fängt an zu blinken.

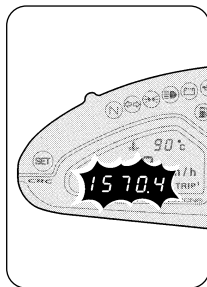
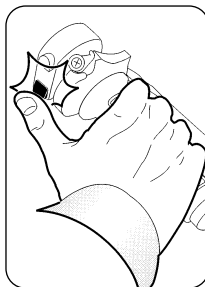
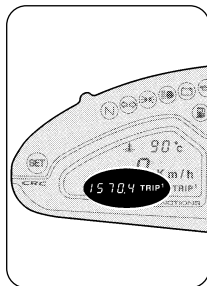
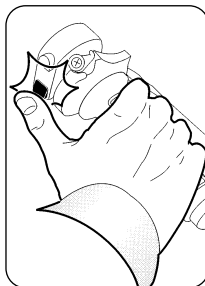



► Wird der Anlasserschalter kürzer als 4 Sekunden gedrückt, wird der angezeigte Wert am Display auf Null zurückgestellt. Wird der Anlasserschalter hingegen länger als 4 Sekunden gedrückt gehalten, wird das Nullstellen abgebrochen.

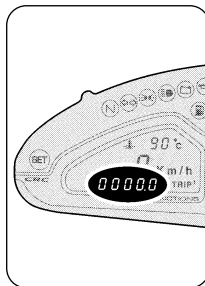
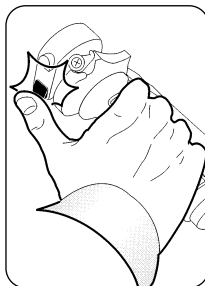

► Durch Drücken des Anlasserschalters die Funktion "TRIP2" einschalten.

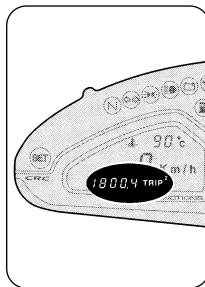
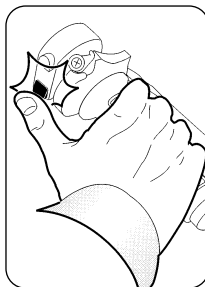

4 DE



► Wird der Anlasserschalter länger als 4 Sekunden gedrückt gehalten; der Wert "TRIP 2" fängt an zu blinken.

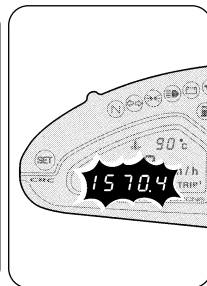
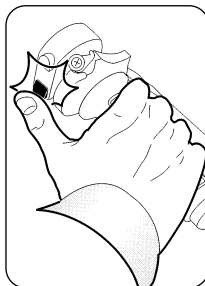

► Wird der Anlasserschalter kürzer als 4 Sekunden gedrückt, wird der angezeigte Wert am Display auf Null zurückgestellt. Wird der Anlasserschalter hingegen länger als 4 Sekunden gedrückt gehalten, wird das Nullstellen abgebrochen.

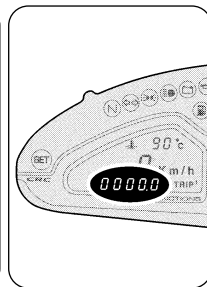
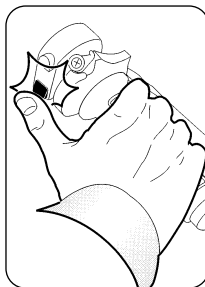



4.4.4. Einstellen der Uhrzeit

Die Uhrzeit kann wie folgt eingestellt werden.



ACHTUNG

Änderungen oder Einstellung der Display-Funktionen müssen bei laufendem Motor, eingelegetem Leerlauf, angehaltenem Motorrad und beiden Füßen auf der Erde vorgenommen werden. Einstellungen am Display während der Fahrt zu ändern ist verboten.

- ▶ Den Anlasserschalter mehrfach drücken, bis die Uhrzeit angezeigt wird.
- ▶ Den Druckschalter "SET" drücken, die erste Ziffer der Stundenanzeige beginnt zu blinken.

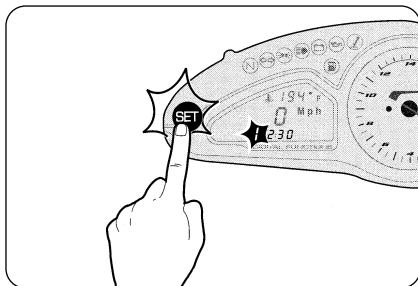
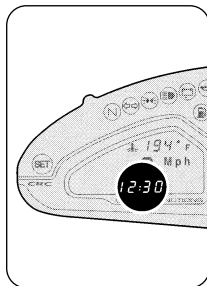
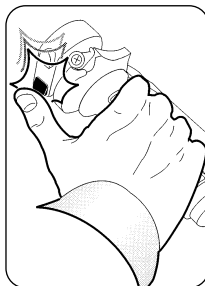



► Den Druckschalter drücken und loslassen, sobald die gewünschte Ziffer erreicht ist.

ANMERKUNG

Zum Schnelldurchlauf der Ziffern den Anlasserschalter länger als 2 Sekunden gedrückt halten.

► Zur Bestätigung der Eingabe den Schalter "SET" drücken und mit der Einstellung der zweiten Ziffer weitermachen.

► Die gleiche Vorgehensweise wie oben gilt für die zweite Ziffer sowie die erste und zweite Ziffer der Minutenanzeige.

► Zur Bestätigung der Uhrzeiteinstellung oder zum Abbrechen (Blinken) den Schalter "SET" drücken.

ANMERKUNG

Die Instrumentenausstattung hat einen integrierten Speicher, der alle Parameter auch bei ausgeschaltetem Motor speichert. Beim Abklemmen der Batterie wird dieser Speicher nicht gelöscht, in diesem Fall wird nur die Uhrzeit auf Null zurückgestellt.

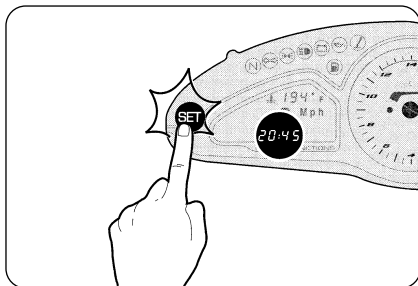
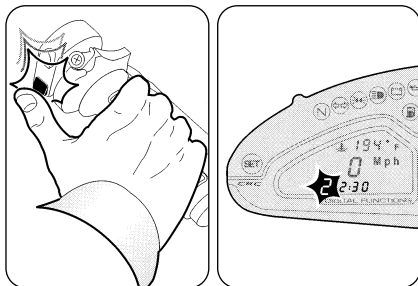



4.4.5. Chronometer

► Der Chronometer kann nur eingeschaltet werden, wenn eine der folgenden Funktionen am Display angezeigt werden:

- Kilometerzähler Gesamtkilometer "TOTAL"
- Kilometerzähler Tageskilometer 1 "TRIP 1"
- Kilometerzähler Tageskilometer 2 "TRIP 2"
- Uhrzeit

► Für mindestens 2 Sekunden gleichzeitig den Schalter "SET" und den Anlasserschalter drücken. Auf diese Weise wird die Chronometerfunktion eingeschaltet. Am Display werden die Ziffern "00:00.0" angezeigt.



ACHTUNG

Änderungen oder Einstellung der Display-Funktionen müssen bei laufendem Motor, eingelegetem Leerlauf, angehaltenem Motorrad und beiden Füßen auf der Erde vorgenommen werden. Einstellungen am Display während der Fahrt zu ändern ist verboten.

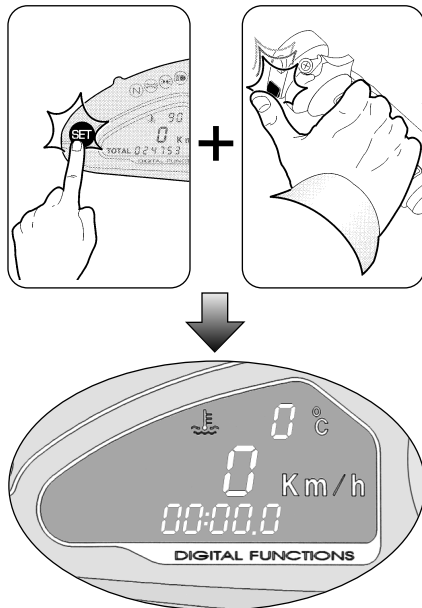



□ Zeitmessung

Nach Einschalten der Chronometerfunktion kann durch Betätigung des Lichttupenschalters mit der Zeitmessung begonnen werden. Die Zeitmessung beginnt mit der Betätigung des Lichttupenschalters. Die Trennpunkte zwischen der Minuten- und Sekundenanzeige sowie zwischen Sekunden- und Zehntelsekundenanzeige beginnen zu blinken. Das Instrument hat mit der Zeitmessung begonnen.

DE 4

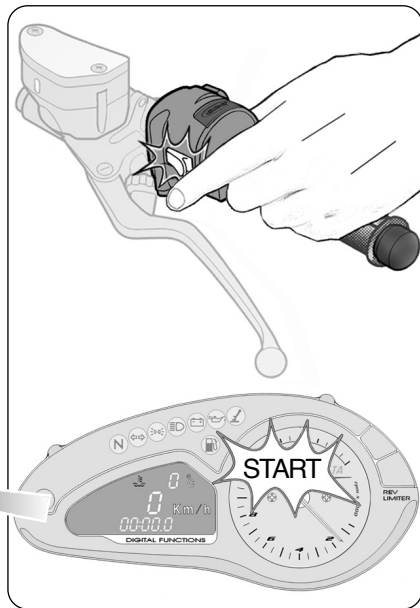
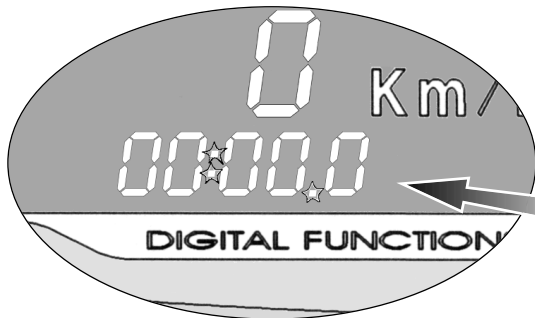



Bei erneuter Betätigung des Lichthupenschalters wird die erste Rundenzeit registriert. Gleichzeitig beginnt die Zeitmessung für die zweite Runde.

Die erste Rundenzeit wird gespeichert und bis zur Erfassung der nächsten Rundenzeit am Display angezeigt.

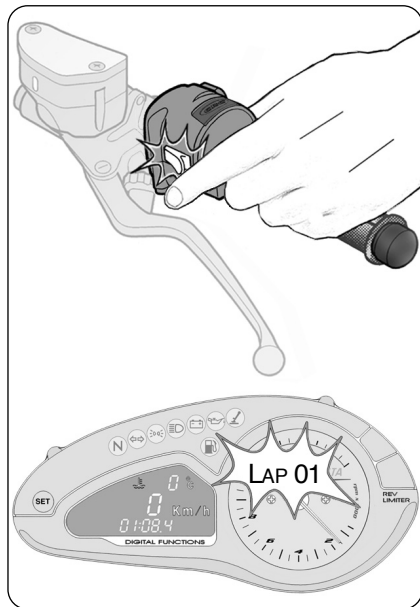



Bei jeder weiteren Betätigung des Lichthupenschalters werden weitere Zeiten erfasst und gespeichert. Das Instrument kann bis zu 80 aufeinander folgende Zeiten speichern.

Ist die letzte gemessene Zeit kürzer als die in der vorherigen Runde gefahrene Zeit, wird an Display ein Minuszeichen " - " vor der Ziffer eingeblendet.

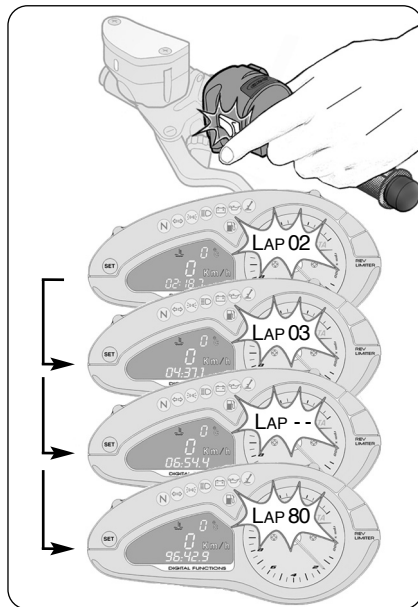
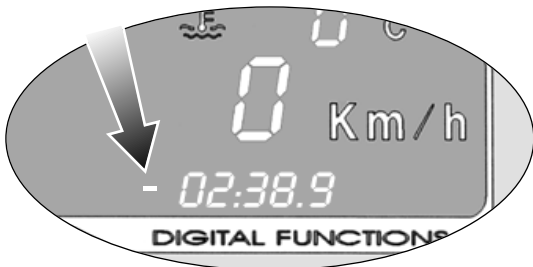



□ Anzeige der Zeitwerte

Nach Abschluss der Zeiterfassung können die gespeicherten Rundenzeiten am Display angezeigt werden.

ANMERKUNG

Auf keinen Fall den Motor abstellen, da andernfalls alle gespeicherten Werte gelöscht werden.

- ▶ Den Schalter "SET" für 0,25 bis 2 Sekunden drücken.

ANMERKUNG

Wird der Schalter "SET" länger als 2 Sekunden gedrückt, werden die gespeicherten Werte gelöscht.

- ▶ Am Display erscheint der Schriftzug "LAP 01", nach 1 Sekunde wird der für Runde 1 gespeicherte Wert am Display angezeigt.

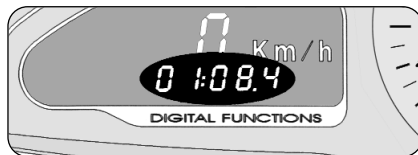
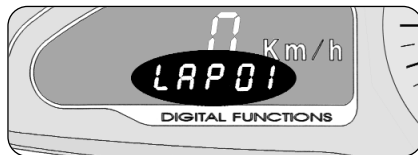
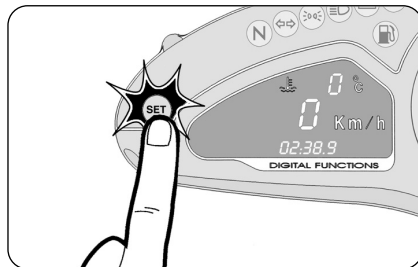



► Nach Betätigung des Lichtupenschalters erscheint am Display der Schriftzug "LAP 02", nach 1 Sekunde wird der für Runde 2 gespeicherte Wert am Display angezeigt.

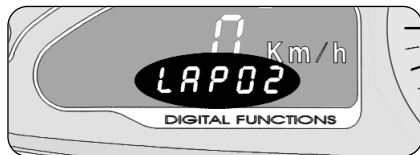
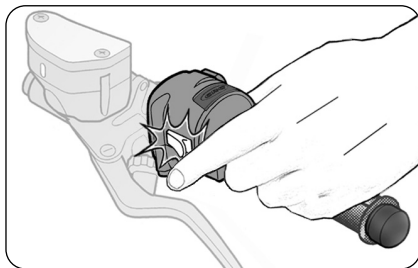

► Durch weitere Betätigung des Lichtupenschalters werden nach und nach alle folgenden Rundenzeiten angezeigt. Wird nach Anzeige der letzten Rundenzeit erneut der Lichtupenschalter betätigt, wird erneut die erste Rundenzeit ("LAP 01") angezeigt.

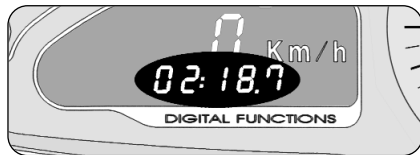



□ Anzeige der schnellsten Rundenzeiten

- ▶ Sicherstellen, dass das Display auf die Anzeige der Zeitwerte eingestellt ist und das am Display die erste Rundenzeit ("LAP 01") angezeigt wird.
- ▶ Den Schalter "SET" für 2 Sekunden oder länger drücken.

ANMERKUNG

Wird der Schalter "SET" kürzer als 2 Sekunden gedrückt, werden die gespeicherten Werte gelöscht.

- ▶ Am Display wird zuerst die Rundenummer mit der besten registrierten Zeit angezeigt. Nach 1 Sekunde wird die Rundenzeit angezeigt.

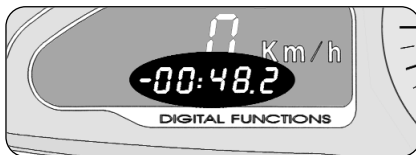
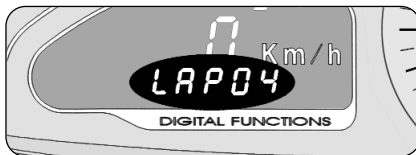
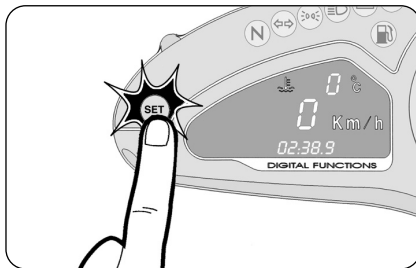



□ Zurückstellen auf Modalität Zeitmessung

► Durch Drücken des Schalters "SET" für 0,25 bis 2 Sekunden drücken wird auf Modalität Zeitmessung zurückgestellt. In dieser Modalität können weitere Rundenzeiten erfasst oder neu mit der Zeiterfassung begonnen werden.

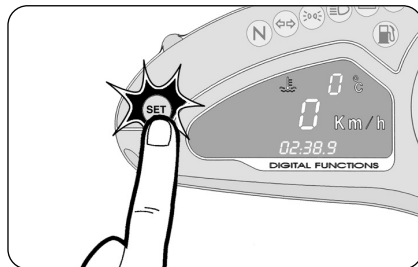

► Nach Drücken des Schalters "SET", wird am Display die letzte gespeicherte Rundenzeit angezeigt.

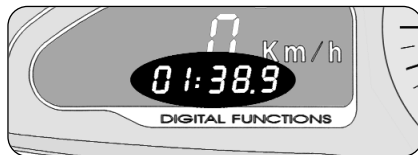

ANMERKUNG

Sind vor dem Zurückstellen auf die Modalität Zeitmessung keine Daten gespeichert worden, wird am Display die Ziffer "00:00.0" angezeigt.

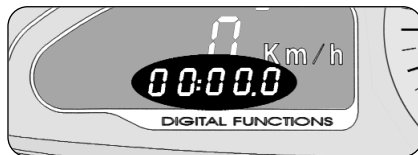



□ Löschen der gespeicherten Werte

Alle gespeicherten Werte werden gelöscht, wenn der Schalter "SET" zwei Sekunden lang gedrückt wird.

ANMERKUNG

Einmal gelöschte Daten können sind endgültig verloren. Das Löschen der Daten kann auch während des Chronometerbetriebs vorgenommen werden. In diesem Fall wird das Zeitnehmen unterbrochen.

Nach dem Löschen wird am Display "00:00.0" angezeigt.

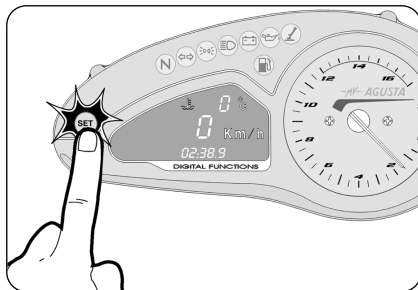

4

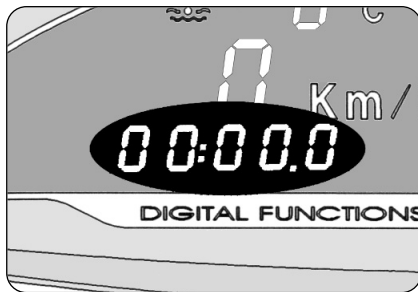



4.5. Tanken



Gefahr - Achtung: Benzin und Benzindämpfe sind leicht entzündbar und giftig. Kontakt mit Benzin und Einatmen vermeiden. Beim Tanken den Motor abschalten und nicht rauchen, offene Flammen und Hitzequellen fernhalten. Im Freien oder in gut belüfteten Räumen tanken.



Vorsicht - Vorsichtsmassnahme: Ausschließlich bleifreies Superbenzin mit einer Oktanzahl (R.O.N.) von 95 oder mehr tanken. Der grüne Punkt auf der unteren Seite der Behälterkappe dient als Anzeige für den Gebrauch des bleifreien Benzins.

- ▶ Den Staubschutzdeckel anheben.
 - ▶ Den Schlüssel in das Schloß stecken, in Uhrzeigersinn drehen und den Tankdeckel anheben.
 - ▶ Nach dem Tanken den Tankdeckel nach unten drücken und gleichzeitig den Schlüssel in Uhrzeigersinn drehen. Den Schlüssel loslassen und abziehen.

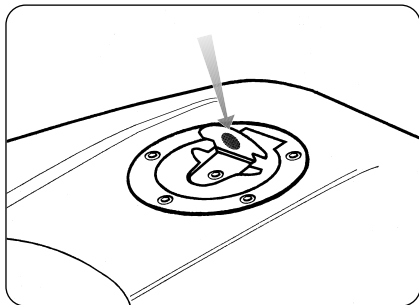
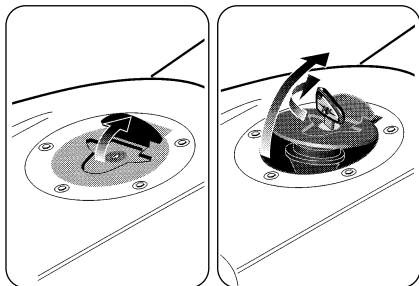

**ACHTUNG**

Wird der Tank bis zum Rand gefüllt, kann Benzin austreten, das sich das Benzin durch Sonneneinwirkung oder die Motorwärme ausdehnen kann. Bei austretendem Benzin besteht Brandgefahr. Der Benzinstand darf nie über dem Ende des Einfüllstutzens stehen.



Vorsicht - Vorsichtsmassnahme: Eventuelle ausgetropftes Benzin sofort mit einem sauberen Lappen abwischen, andernfalls können Lack oder Plastikteile beschädigt werden.

**ACHTUNG**

Vorm Losfahren prüfen, ob der Tankdeckel richtig verschlossen ist.

4.6. Zugang zum Staufach

- ▶ Den Schlüssel in das Schloß stecken.
- ▶ Das Heckteil nach unten drücken und gleichzeitig den Schlüssel in Uhrzeigersinn drehen.
- ▶ Das Heckteil am hinteren Ende leicht anheben, nach hinten schieben und bis auf den Tank umklappen.

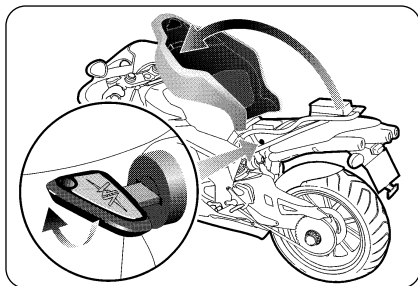



4.7. Parken des Motorrads

☐ Parken auf dem Seitenständer



VORSICHT

- Das Motorrad stets sicher auf festem Untergrund abstellen.
- Beim Parken auf abschüssigem Gelände das Vorderrad bergauf stellen und den ersten Gang einlegen. Vorm Starten muss wieder der Leerlauf eingelegt werden.
- Niemals den Zündschlüssel stecken lassen, wenn das Fahrzeug unbeaufsichtigt ist.

- ▶ Den Seitenständer mit dem Fuß bis zum Anschlag ausklappen und das Motorrad langsam neigen, bis der Ständerfuß auf dem Untergrund fest aufliegt.

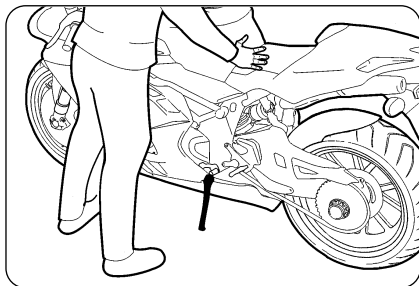

**ACHTUNG**

Wird das Motorrad zum Parken auf den Seitenständer gestellt, ist es gefährlich sich auf das Fahrzeug zu setzen, da das gesamte Gewicht nur auf dem Seitenständer aufliegt.

**ACHTUNG**

Vorm Losfahren die Funktion des Sicherheitsschalters prüfen. Die Kontrolllampe am Armaturenbrett für den abgeklappten Seitenständer muss sich ausschalten. Auf jeden Fall prüfen, dass der Seitenständer richtig hochgeklappt ist.

Wird eine Störung bemerkt, muss die Anlage vor Fahrtantritt bei einem MV Agusta Vertragshändler überprüft werden.

☐ Parken auf dem hinteren Ständer

Den Zapfen des Ständer von der linken Fahrzeugseite aus in die Öffnung an der Radachse stecken. Den Ständer auf den Boden stellen, festhalten und das Fahrzeug soweit anheben, bis es sicher steht.

**VORSICHT**

Dieser Vorgang muss von zwei Personen zusammen ausgeführt werden.

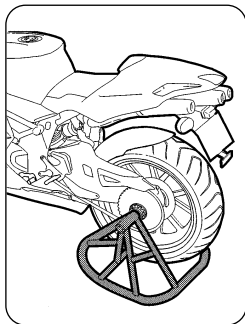
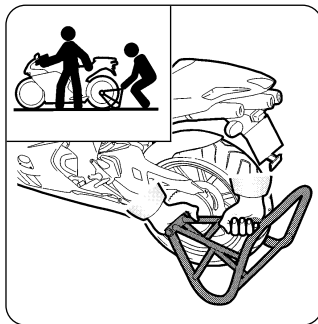



5.1. Liste der Einstellungsarbeiten

Das Motorrad bietet eine breite Auswahl von Einstellungsmöglichkeiten, die Ergonomie, die Sitzposition und die Sicherheit verbessern können.

Da eine falsche Einstellung von wichtigen Komponenten eine Gefahrenquelle darstellen kann, dürfen einige dieser Einstellungen nur von einer MV Agusta-Vertragswerkstatt vorgenommen werden.



ACHTUNG

Alle Einstellungsarbeiten müssen bei stehendem Fahrzeug vorgenommen werden.



(F) Einstellung Rückspiegel (§5.5.)

(A) Einstellung Kupplungshebel (§5.4.)

(F) Einstellung Rückspiegel (§5.5.)

(C) Einstellung der rechten
Fußraste (§5.2.)

(E) Einstellung Bremspedal
Hinterradbremse (§5.2.)

(B) Einstellung Bremshebel
Vorderradbremse (§5.3.)

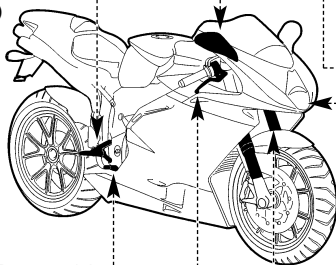

(H) Einstellung vordere
Federung (§5.7.)

(N) Einstellung
Scheinwerfer (§5.9.)

(G) Einstellung
Lenkungsdämpfer (§5.6.)

(D) Einstellung
Schaltpedal (§5.2.)

(L) Einstellung hintere
Federung (§5.8.)

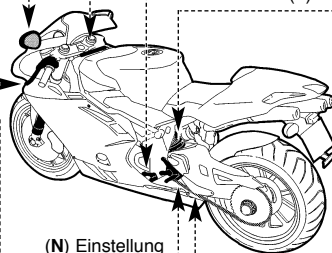

(M) Einstellung
Kette (§5.2.)

(C) Einstellung der linken
Fußraste (§5.2.)



5.2. Tabelle der Einstellungsarbeiten



A - Einstellung Kupplungshebel: Bessere Einstellung des Kupplungshebels auf die persönlichen Anforderungen des Fahrers (§5.4).



B - Einstellung Bremshebel Vorderradbremse: Bessere Einstellung des Bremshebels auf die persönlichen Anforderungen des Fahrers (§5.3).



C - Einstellung der Fußrasten (rechts und links): um abhängig von den Ansprüchen des Fahrers die günstigste Fußstellung einzustellen.



D - Einstellung Schaltpedal: Bessere Einstellung des Schaltpedals auf die persönlichen Anforderungen des Fahrers.



E - Einstellung Bremspedal Hinterradbremse: Bessere Einstellung des Bremspedals auf die persönlichen Anforderungen des Fahrers.



F - Einstellung Rückspiegel: Zur besseren Einstellung (§5.5).



G - Einstellung Lenkungsdämpfer: Einstellung der Dämpfung auf die persönlichen Anforderungen des Fahrers (§5.6.).



H - Einstellung vordere Federung: um die Federung an den persönlichen Fahrstil anzupassen, gibt es folgende Einstellmöglichkeiten:

- Federvorspannung (§5.7.1.)
- Hydraulische Ausdehnungsbremse (§5.7.2.)
- Hydraulische Kompressionsbremse (§5.7.3.)



L - Einstellung hintere Federung: um die Federung an den persönlichen Fahrstil anzupassen, gibt es folgende Einstellmöglichkeiten:

- Höhe Sitzposition
- Federvorspannung (§5.8.1.)
- Hydraulische Ausdehnungsbremse (§5.8.2.)
- Hydraulische Kompressionsbremse – Hohe Gänge (§5.8.3.)
- Hydraulische Kompressionsbremse – Niedrige Gänge (§5.8.4.)



M - Einstellung Kette: Für Funktion und Sicherheit des Antriebs.



N - Einstellung Scheinwerfer: Um den Lichtstrahl des Scheinwerfers entsprechend der Sitzposition einzustellen (§5.9).



5.3. Einstellung Bremshebel Vorderradbremse

Den Hebel ziehen, um den Federdruck auszugleichen. Gleichzeitig die Hebelposition durch Drehen der Nutmutter einstellen. Drehen in Uhrzeigersinn: der Hebel entfernt sich vom Handgriff. Drehen gegen den Uhrzeigersinn: der Hebel nähert sich an den Handgriff an.

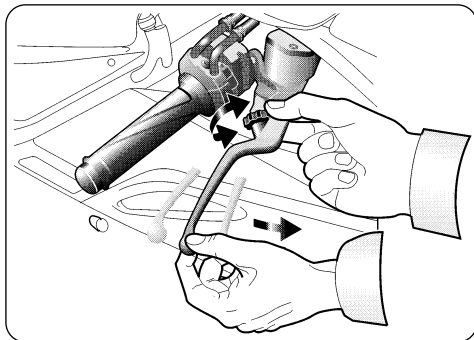

5.4. Einstellung Kupplungshebel

Den Hebel ziehen, um den Federdruck auszugleichen. Gleichzeitig die Hebelposition durch Drehen der Nutmutter einstellen. Drehen in Uhrzeigersinn: der Hebel entfernt sich vom Handgriff. Drehen gegen den Uhrzeigersinn: der Hebel nähert sich an den Handgriff an.

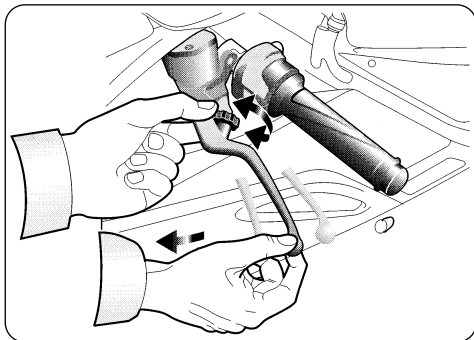



5.5. Einstellung Rückspiegel

Zur Einstellung des Rückspiegels an den vier in der Abbildung gezeigten Stellen drücken.

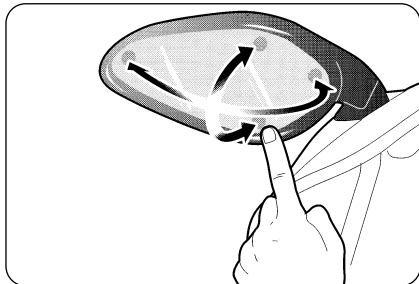

DE 5

5.6. Einstellung Lenkungsdämpfer

Für die Standardeinstellung wird der Einstellungsknauf gegen den Uhrzeigersinn bis zum Anschlag gedreht. In dieser Stellung wird die Lenkung am wenigsten gedämpft.

Je nach persönlichen Bedürfnissen kann die Dämpfungswirkung durch Drehen des Einstellungsknauf in Uhrzeigersinn erhöht werden.

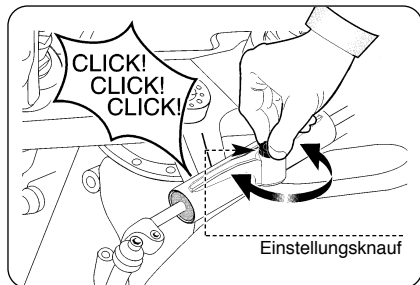



5.7. Einstellung vordere Federung



ACHTUNG

Die Einstellvorrichtungen müssen an beiden Gabelbeinen gleich eingestellt werden.

ANMERKUNG

Die Einstellung der Federungen muß vorzugsweise mit dem Benzintank volle durchgeführt werden.

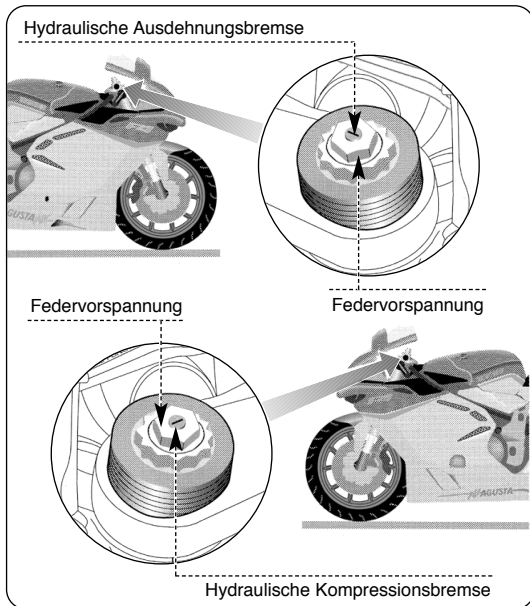



5.7.1. Federvorspannung (Vorderradfederung)

Für die Einstellungsarbeiten muß von der Standardeinstellung ausgegangen werden. Um die Standardeinstellung zu erreichen, gegen den Uhrzeigersinn bis zum Anschlag drehen, anschließend in Uhrzeigersinn bis Standardposition (siehe beiliegende Tabelle) drehen. In Uhrzeigersinn drehen um die Federvorspannung zu erhöhen, gegen den Uhrzeigersinn drehen, um die Federvorspannung abzuschwächen.

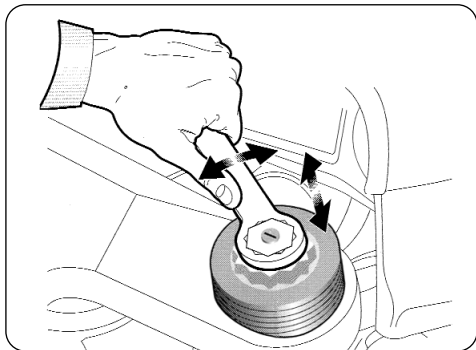

5.7.2. Hydraulische Ausdehnungsbremse (Vorderradfederung)

Für die Einstellungsarbeiten muß von der Standardeinstellung ausgegangen werden. Um die Standardeinstellung zu erreichen, in Uhrzeigersinn bis zum Anschlag drehen, anschließend gegen den Uhrzeigersinn bis Standardposition (siehe Tabelle) drehen. In Uhrzeigersinn drehen um die Bremsleistung zu erhöhen, gegen den Uhrzeigersinn drehen, um die Bremsleistung abzuschwächen.

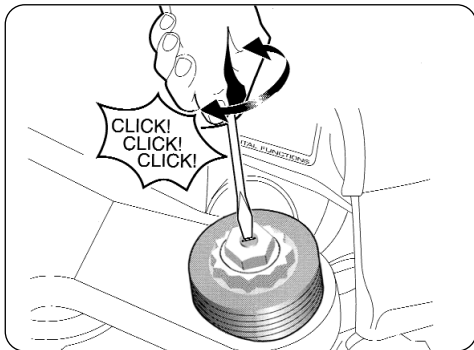

5.7.3. Hydraulische Kompressionsbremse (Vorderradfederung)

Für die Einstellungsarbeiten muß von der Standardeinstellung ausgegangen werden. Um die Standardeinstellung zu erreichen, in Uhrzeigersinn bis zum Anschlag drehen, anschließend gegen den Uhrzeigersinn bis Standardposition (siehe Tabelle) drehen. In Uhrzeigersinn drehen um die Bremsleistung zu erhöhen, gegen den Uhrzeigersinn drehen, um die Bremsleistung abzuschwächen.

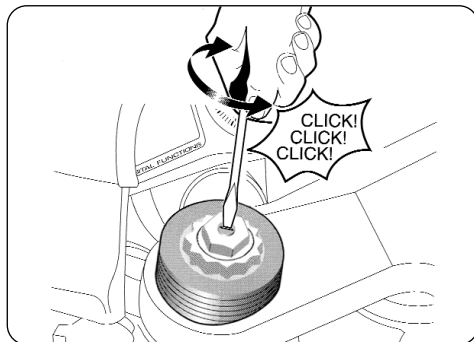



5.8. Einstellung hintere Federung



ACHTUNG: Die Auspuffrohre sind heiß - Verbrennungsgefahr. Den Motor ausschalten und vor der Einstellung abwarten, bis die Auspuffrohre abgekühlt sind.



ACHTUNG: Der Stoßdämpfer enthält unter hohem Druck stehendes Gas. Den Stoßdämpfer auf keinen Fall zerlegen.



VORSICHT: Um die Einstellung der Hinterradfederung einschätzen zu können, niemals an den Auspuff-Endrohren anfassen. Die Auspuff-Endrohre könnten beschädigt werden.

ANMERKUNG: Bei Fahrzeugübergabe ist die hintere Federung nach der Standardkonfiguration (siehe beiliegende Tabelle) geregelt.

ANMERKUNG: Die Einstellung der Federungen muß vorzugsweise mit dem Benzintank volle durchgeführt werden.

DE 5

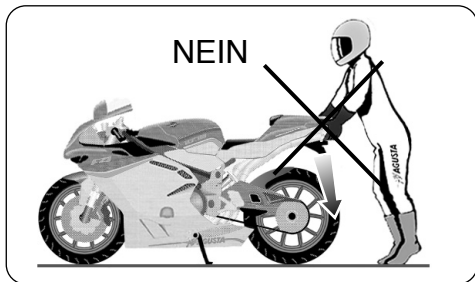
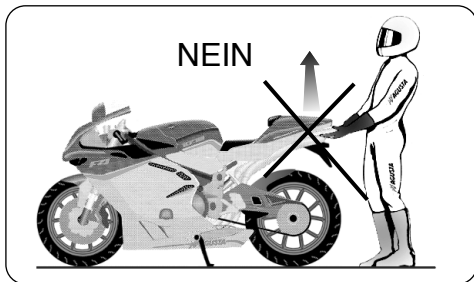

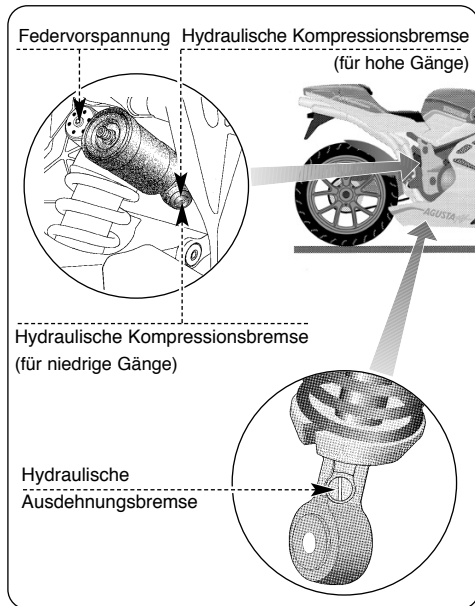

5.8.1. Federvorspannung (Hinterradfederung)

Für die Einstellungsarbeiten muß von der Standardeinstellung ausgegangen werden. Um die Standardeinstellung zu erreichen, gegen den Uhrzeigersinn bis zum Anschlag drehen, anschließend in Uhrzeigersinn bis Standardposition (siehe beiliegende Tabelle) drehen. In Uhrzeigersinn drehen um die Federvorspannung zu erhöhen, gegen den Uhrzeigersinn drehen, um die Federvorspannung abzuschwächen.



VORSICHT: Drehen Sie nicht die Schraube hinter seiner völlig Uhrzeigersinn oder gegen Uhrzeigersinn, um die Beschädigung der hydraulischen Vorrichtung zu vermeiden.

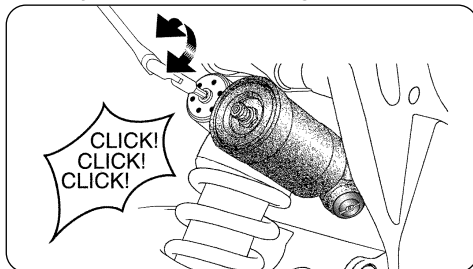

5.8.2. Hydraulische Ausdehnungsbremse (Hinterradfederung)

Für die Einstellungsarbeiten muß von der Standardeinstellung ausgegangen werden. Um die Standardeinstellung zu erreichen, in Uhrzeigersinn bis zum Anschlag drehen, anschließend gegen den Uhrzeigersinn bis Standardposition (siehe Tabelle) drehen. In Uhrzeigersinn drehen um die Bremsleistung zu erhöhen, gegen den Uhrzeigersinn drehen, um die Bremsleistung abzuschwächen.

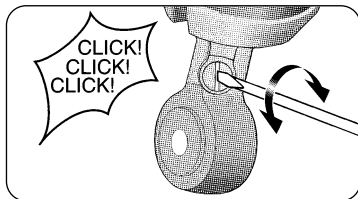
5.8.3. Hydraulische Kompressionsbremse für hohe Gänge (Hinterradfederung)

Für die Einstellungsarbeiten muß von der Standardeinstellung ausgegangen werden. Um die Standardeinstellung zu erreichen, gegen den Uhrzeigersinn bis zum Anschlag drehen, anschließend in Uhrzeigersinn bis Standardposition (siehe Tabelle) drehen. In Uhrzeigersinn drehen um die Bremsleistung zu erhöhen, gegen den Uhrzeigersinn drehen, um die Bremsleistung abzuschwächen.

5.8.4. Hydraulische Kompressionsbremse für niedrige Gänge (Hinterradfederung)

Für die Einstellungsarbeiten muß von der Standardeinstellung ausgegangen werden. Um die Standardeinstellung zu erreichen, in Uhrzeigersinn bis zum Anschlag drehen, anschließend gegen den Uhrzeigersinn bis Standardposition (siehe Tabelle) drehen. In Uhrzeigersinn drehen um die Bremsleistung zu erhöhen, gegen den Uhrzeigersinn drehen, um die Bremsleistung abzuschwächen.

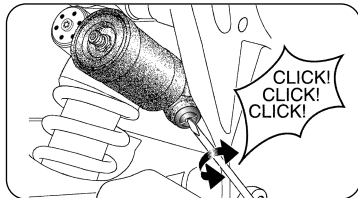



5.9. Scheinwerfereinstellung

Das Fahrzeug auf ebenem Untergrund in einem Abstand von 10 m vor eine Wand stellen. Das Fahrzeug muss aufrecht senkrecht zur Wand stehen. Den Abstand zwischen Scheinwerfermitte und Boden messen. Den Wert an der Wand mit einem Kreuz anzeichnen. Den Scheinwerfer einschalten und Fahrlicht einstellen. Den Lichtstrahl so einstellen, dass sich die Hell-Dunkel-Linie 9/10 unterhalb der an der Wand angebrachten Linie befindet. Der Scheinwerfer kann in einem Bereich von $\pm 4^\circ$ horizontal eingestellt werden.

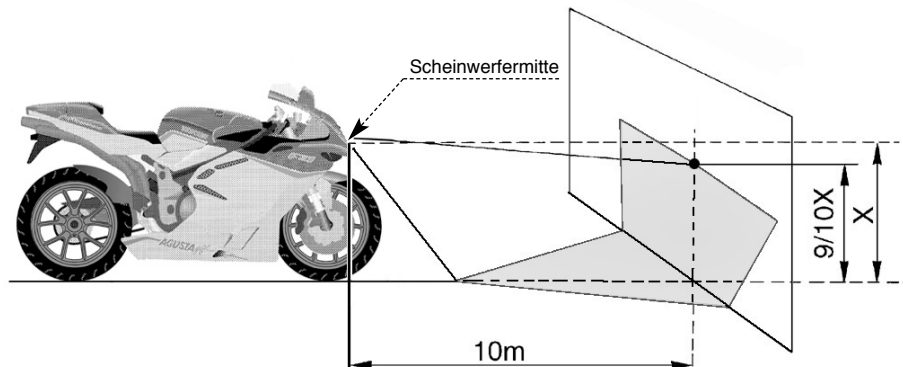



Informationshinweis

MV Agusta S.p.A. verfolgt eine Politik ständiger Verbesserung ihrer Produkte. Aus diesem Grund kann es vorkommen, dass kleine Abweichungen zwischen dem vorliegenden Dokument und dem von Ihnen erworbenen Fahrzeug bestehen. Die Modelle MV Agusta werden in zahlreiche Länder exportiert, in denen unterschiedliche Straßenverkehrsordnungen und Zulassungsverfahren bestehen. In der Hoffnung auf Ihr Verständnis behält sich MV Agusta S.p.A. deshalb das Recht vor, jederzeit und ohne Vorankündigung, Änderungen an ihren Produkten und den technischen Dokumentationen vorzunehmen.

Wir schlagen vor, um den Internetplatz www.mvagusta.it häufig zu besichtigen, um Informationen und Updates über die MV Agusta-Produkte und die in Verbindung stehenden Unterlagen zu erhalten.



Die Umwelt schützen und respektieren

Alles was wir tun hat Auswirkungen auf den gesamten Planeten und seine Ressourcen. Zum Schutz der Gemeinschaft weist MV Agusta die Kunden und die Angestellten im Kundendienst darauf hin, wie das Motorrad umweltschonend genutzt und Motorradbauteile und Flüssigkeiten entsprechend der geltenden Umweltschutzgesetze entsorgt bzw. dem Recycling zugeführt werden können.

© 2007

Die vollständige oder teilweise Vervielfältigung dieses Dokuments ist ohne vorherige schriftliche Genehmigung der MV Agusta S.p.A. verboten.

Teilnr. 8000B1113

Ausgabe Nr. 1 - November 2007

MV AGUSTA



Manual de uso
Versión en Español

BIERA
100

Estimado cliente:

Le agradecemos la confianza que nos ha otorgado y le felicitamos por su nueva F4 312.

Su elección premia el compromiso y el esfuerzo hecho con pasión por nuestros técnicos que han dado a la F4 312 características funcionales y estéticas que la sitúan por encima de las motos de más alto nivel hoy en el mercado, convirtiéndola en un objeto codiciado y exclusivo.

Si desde el punto de vista puramente técnico la F4 312 representa, con sus innumerables innovaciones, un punto de referencia a nivel mundial, su línea sin tiempo, suave y aerodinámica, es una espléndida fusión entre un glorioso pasado y un nuevo milenio.

La unión de estos elementos, que sólo la búsqueda del detalle, la pasión y el deseo de realizar una moto técnicamente y estéticamente superior han permitido lograr, pone a la F4 312 por encima de cualquier moda pasajera, dándole así el privilegio de ser considerada un objeto único en el mundo.

Si desea más información, no dude en ponerse en contacto con el Servicio de Asistencia Clientes de MV Agusta.

¡Buena diversión!

*Claudio Castiglioni
Presidente
MV Agusta*



ÍNDICE GENERAL

<i>Cap.</i>	<i>Descripción temas</i>	<i>pág.</i>	<i>Cap.</i>	<i>Descripción temas</i>	<i>pág.</i>
1	INFORMACIÓN GENERAL	5	4	USO	27
1.1.	Finalidad del manual	5	4.1.	Uso de la motocicleta	27
1.2.	Símbolos	6	4.2.	Rodaje	28
1.3.	Contenido del CD-Rom	7	4.3.	Arranque del motor	30
1.4.	Datos de identificación	8	4.4.	Selección y modificación funciones display	32
2	INFORMACIÓN SOBRE LA SEGURIDAD	10	4.4.1.	Selección de las funciones de la pantalla	33
2.1.	Uso consentido del vehículo	10	4.4.2.	Ajuste de la unidad de medida	35
2.2.	Mantenimiento	10	4.4.3.	Anulación de las funciones cuentakilómetros parciales	38
2.3.	Accesorios y modificaciones	11	4.4.4.	Ajuste de la función reloj	41
2.4.	Carga vehículo	11	4.4.5.	Cronómetro	43
3	MANDOS Y INSTRUMENTOS	13	4.5.	Reabastecimiento combustible	52
3.1.	Posición mandos y instrumentos	13	4.6.	Acceso al hueco portaobjetos	53
3.2.	Caballote lateral	14	4.7.	Estacionamiento de la motocicleta	54
3.3.	Mandos semimanillar izquierdo	15	5	REGULACIONES	56
3.4.	Mandos semimanillar derecho	17	5.1.	Lista de las regulaciones	56
3.5.	Interruptor encendido y bloqueo del manillar	20	5.2.	Tabla de las regulaciones	58
3.6.	Mando cambio	22	5.3.	Regulación de la palanca del freno delantero	59
3.7.	Instrumentos y testigos	23	5.4.	Regulación de la palanca de embrague	59
3.7.1.	Testigos	24	5.5.	Regulación de los espejos retrovisores	60
3.7.2.	Pantalla multifunción	25	5.6.	Regulación del amortiguador de dirección	60
3.8.	Tabla de lubricantes y líquidos	26			



ÍNDICE GENERAL

<i>Cap.</i>	<i>Descripción temas</i>	<i>pág.</i>
5.7.	Regulación de la suspensión delantera	61
5.7.1.	Precarga muelle (suspensión delantera)	62
5.7.2.	Dispositivo hidráulico de frenado en extensión (suspensión delantera)	62
5.7.3.	Dispositivo hidráulico de frenado en compresión (suspensión delantera)	63
5.8.	Regulación de la suspensión trasera	64
5.8.1.	Precarga muelle (suspensión trasera)	65
5.8.2.	Dispositivo hidráulico de frenado en extensión (suspensión trasera)	66
5.8.3.	Dispositivo hidráulico de frenado en compresión para alta velocidad (suspensión trasera)	66
5.8.4.	Dispositivo hidráulico de frenado en compresión para baja velocidad (suspensión trasera)	66
5.9.	Ajuste proyector delantero	67



1.1. Finalidad del manual

El presente manual proporciona toda la información necesaria para un uso correcto y seguro de la moto.

Junto al manual se entrega también un “Quick Manual” de bolsillo, con una síntesis esencial de la información necesaria para el uso del vehículo.

El manual se entrega también en formato electrónico (.pdf) en este CD-Rom, y puede ser impreso o visualizado en cualquier ordenador, ya sea en sistema Windows que Macintosh.

Le recomendamos leer atentamente el manual antes de utilizar la moto y cerciorarse de cualquier otra persona que la use haya hecho lo mismo.

Por último, le aconsejamos llevar siempre con Usted el “Quick Manual” y de rellenarlo con los datos identificativos suyos y de la motocicleta.



Copyright
MV AGUSTA Motor Spa
Todos los derechos reservados



1.2. Símbolos

Las partes del texto de particular importancia, correspondientes a la seguridad de la persona y a la integridad de la motocicleta, están evidenciadas con los siguientes símbolos:



Peligro - Atención: la falta o el incompleto cumplimiento de estas prescripciones puede comportar un grave peligro para su incolumidad o para la de otras personas.



Prudencia - Precaución: la falta o el incompleto cumplimiento de estas prescripciones puede comportar un riesgo de daños a la motocicleta.

Para indicar las personas autorizadas al desarrollo de las operaciones de ajustes y/o mantenimiento, las mismas se encuentran marcadas con los símbolos siguientes:



Información de las operaciones permitidas al motociclista.



Información de las operaciones que deben ser llevadas a cabo sólo por personal autorizado.

Para poner en evidencia ulteriores informaciones se utilizan los siguientes símbolos:



El símbolo  indica que es necesario utilizar una herramienta o utillaje específico para realizar correctamente la operación descrita.



El símbolo “§” indica que nos remitimos al capítulo indicado por el número que lo sigue.



1.3. Contenido del CD-Rom

En el CD-Rom proporcionado Usted podrá encontrar, además de este manual, el Manual de Mantenimiento, el “Quick Manual” (del que también se entrega una versión impresa), la Guía de las Concesionarias y el Folleto de la Garantía.

Al momento de la entrega de la motocicleta, su Concesionario le habrá entregado también el Certificado de Garantía y Pre-Entrega.

Le rogamos conservarlo junto con los documentos de la moto y los futuros cupones de mantenimiento que recibirá cada vez que realice las intervenciones programadas.

IMPORTANTE

La copia del Certificado de Garantía y Pre-entrega destinada a MV Agusta debe ser rellena por el Concesionario y devuelta a la fábrica dentro de 10 días a partir de la fecha de matriculación.

Las copias de los cupones de manutención recomendada deben ser rellenas siempre por los Concesionarios y devueltos a MV Agusta dentro de los 10 días siguientes a la fecha de la realización de las intervenciones.



2) número de matrícula motor

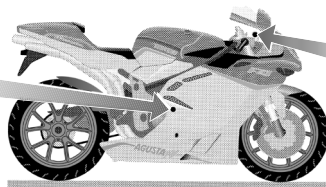
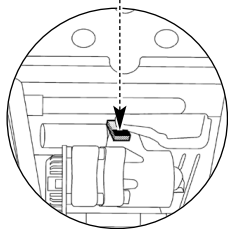

1) número de matrícula del chasis

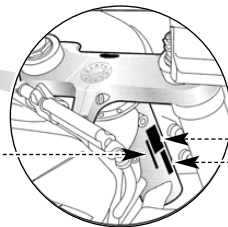

3) datos de homologación

1.4. Datos de identificación

- 1) número de matrícula chasis
- 2) número de matrícula motor
- 3) datos de homologación

► Identificación motocicleta

La motocicleta está identificada por el número de matrícula del chasis. Para pedir piezas de recambio, además de este número, puede ser necesario indicar el número de matrícula del motor, el código del color y el número de identificación de la llave.

Se recomienda anotar los datos principales en los siguientes espacios:

CHASIS N.: _____

MOTOR N.: _____



► Identificación de la llave de la motocicleta

Se suministran dos llaves, una llave se utiliza sea para el arranque para accionar las cerraduras. Guarde en un lugar seguro la llave de reserva.

Tener conocimiento del número de identificación de la llave es indispensable en el caso sea necesario pedir un duplicado de la llave como recambio. Se recomienda anotar el número de identificación de la llave en el espacio siguiente:

LLAVE N.: _____

► Identificación combinación colores motocicleta

El código del color es indispensable para pedir las piezas de recambio de la carrocería. Dicho código se puede leer en la placa ubicada en la parte interior de la cola.

Se aconseja anotar el código color de la motocicleta en el espacio siguiente:

CÓDIGO COLOR : _____

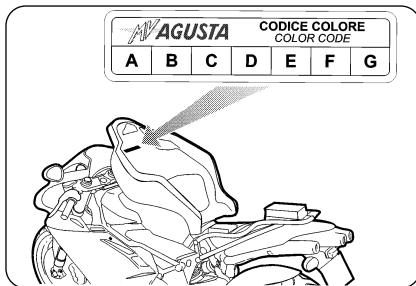
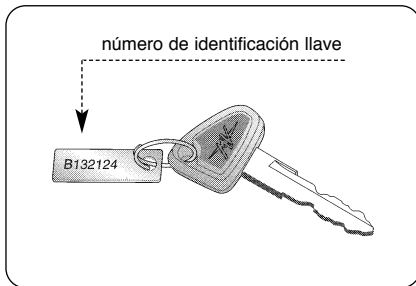



2.1. USO CONSENTIDO DEL VEHÍCULO

Su motocicleta ha sido proyectada para transitar exclusivamente por carreteras y autopistas.



ATENCIÓN

Saltuariamente es posible utilizar la motocicleta en pistas, pero en ocasiones que no prevean la competición. Sin embargo, a causa del mayor esfuerzo al que se somete la moto en tales ocasiones, en ese caso se recomienda hacer controlar las condiciones del vehículo por un Centro de Asistencia MV Agusta antes y después del uso. Cualquier otro uso está prohibido y expresamente excluido.

Para más información acerca del uso de la moto, consulte la sección 4 del presente manual.

2.2. MANTENIMIENTO

A fin de garantizar la máxima eficiencia y fiabilidad del vehículo, es esencial efectuar las intervenciones de mantenimiento previstas en el Manual de Mantenimiento.

MV Agusta recomienda que todas las operaciones de mantenimiento sean efectuadas exclusivamente por personal especializado perteneciente a un Centro de Asistencia MV Agusta.

En caso de que Usted decida efectuar las intervenciones de mantenimiento en otros talleres, deberá constatar que los mismos cuenten con la capacidad y los instrumentos específicos necesarios para la ejecución de tales operaciones.



ATENCIÓN

La garantía MV Agusta puede perder validez en caso de que otros talleres hayan efectuado intervenciones no conformes con las previstas en las Circulares Técnicas y los Manuales de Taller MV Agusta.

**2.3. ACCESORIOS Y MODIFICACIONES****ATENCIÓN**

MV Agusta prohíbe aportar cualquier tipo de modificación a sus motocicletas. Ello es necesario para tutelar la seguridad de sus Clientes.

De todos modos, Usted puede personalizar su motocicleta utilizando los artículos del vasto Catálogo de Accesorios MV Agusta.

**ATENCIÓN**

La instalación de algunos de estos accesorios puede invalidar la homologación de la moto y, por ende, comprometer su posibilidad de tránsito por las vías públicas.

En caso de dudas, le aconsejamos recurrir a su Concesionario MV Agusta de confianza para decidir cuáles son los accesorios más adecuados a sus propias exigencias.

2.4. CARGA DEL VEHICULO

El vehículo en las versiones **F4 1078 RR 312** y **F4 1000 R 312** ha sido proyectado para ser usado solo por el piloto, mientras las versiones **F4 1078 RR 1+1 312** y **F4 1000 R 1+1 312** se pueden usar también transportando un pasajero. Para una utilización totalmente segura y respetando las normas del código del tránsito es obligatorio no superar nunca el peso bruto total máximo permitido de los vehículos, valores indicados a continuación:

F4 1078 RR 312 / F4 1000 R 312

Peso total máximo	340 kg
Peso de la carga máxima	110 kg

F4 1078 RR 1+1 312 / F4 1000 R 1+1 312

Peso total máximo	420 kg
Peso de la carga máxima	180 kg



El peso total máximo representa la adición de los siguientes pesos, según la directiva CEE 92/61:

- peso de la motocicleta;
- peso del piloto;
- peso del pasajero (solo para F4 1078 RR 1+1 312 y F4 1000 R 1+1 312);
- peso de la carga y de los accesorios.



ATENCIÓN: Considerado que la carga tiene una enorme importancia en la manejabilidad, la frenada, el rendimiento y las características de seguridad de vuestro vehículo, tener presente siempre las siguientes precauciones.

- **NO SOBRECARGAR NUNCA EL VEHICULO!** La utilización de una moto sobrecargada puede provocar daños a los neumáticos, pérdida del control o graves accidentes. Comprobar que el peso total del piloto, del pasajero, de la carga y de los accesorios no supere el peso máximo especificado para la moto.



3.1. Posición mandos e instrumentos

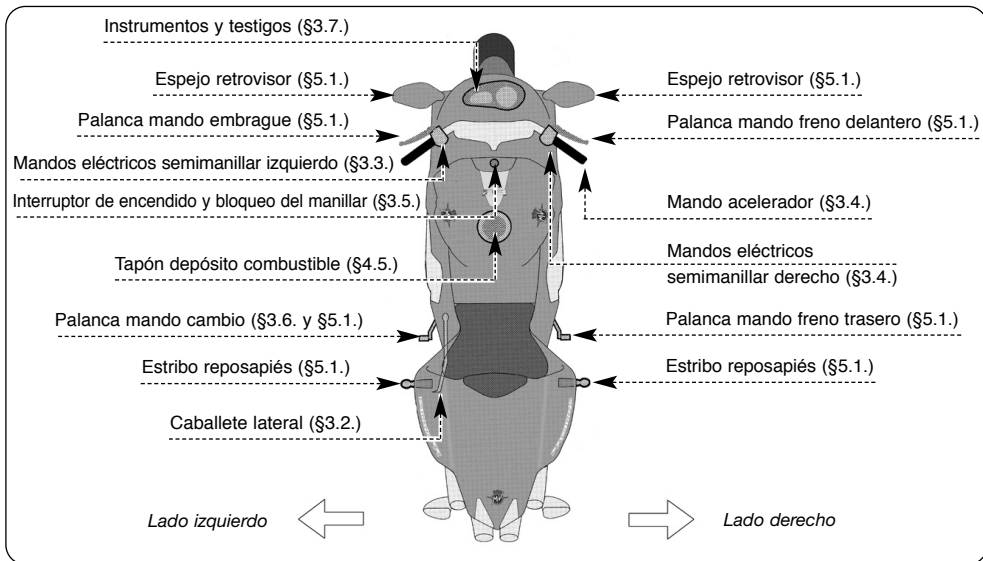



3.2. Caballete lateral

El caballete lateral está equipado con un interruptor de seguridad que impide a la moto de ponerse en marcha con el caballete bajado. En el caso que con el motor en marcha y con el caballete bajado, se acciona el cambio para salir, el interruptor corta la corriente al motor provocando la parada.

En el caso que la moto se encuentre estacionada (con el caballete abajo) y con una velocidad engranada, el interruptor impide el arranque del motor evitando el peligro de caída accidental del vehículo.

ES 3

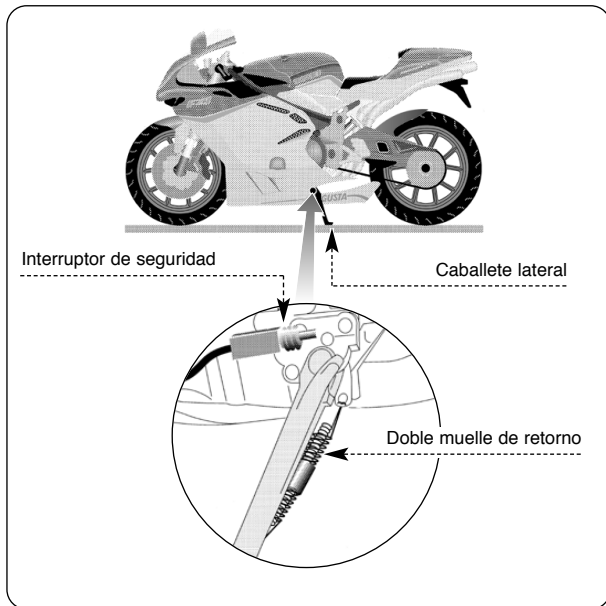

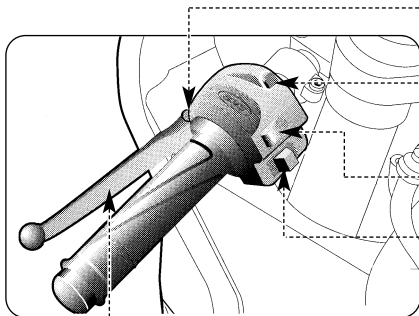
**3.3. Mandos semimanillar izquierdo****Pulsador centelleo faros**

Apriete el pulsador repetidas veces.

Pulsador carretera/cruce

Pulsador hacia fuera ■ : cruce 

Pulsador hacia dentro — : carretera 

Pulsador claxon

Apriete para activar el claxon.

Palanca indicadores de dirección

Desplazando la palanca hacia la derecha o hacia la izquierda se activan los indicadores de dirección derechos o izquierdos. La palanca regresa al centro; apriete para desactivar los indicadores.

Palanca embrague

Acercar o alejar de la manecilla para accionar el embrague.



Pulsador Destello Faro

Esta función sirve para llamar la atención de los demás en el caso de posible situaciones de peligro; con la luz de carretera encendida dicha función no se activa.

Pulsador De carretera/De cruce

Normalmente es activada la función luz de cruce; cuando las condiciones del tráfico y de recorrido lo permiten, puede ser activada la función luz de carretera actuando en el pulsador.

Pulsador del Claxon

Esta función sirve para llamar la atención de los demás conductores en el caso de posible condición de peligro.

Leva Indicadores de Dirección

Esta función permite señalar a los demás la intención de cambiar dirección o carril de marcha.



PELIGRO

No usar o no desactivar los indicadores de dirección en el momento oportuno puede provocar accidentes; los demás conductores podrían interpretar erróneamente el trayecto del vehículo.

Accionar siempre los indicadores de dirección antes de girar o cambiar carril.

Asegurarse después de desactivar los indicadores apenas efectuada dicha maniobra.

Palanca Embrague

Esta palanca, a través de un dispositivo controlado hidráulicamente, permite accionar el embrague.

**3.4. Mandos semimanillar derecho****Interruptor stop motor**

Si se acciona detiene el motor e impide su arranque.

Pulsador arranque motor

Apretado arranca el motor. Se debe soltar apenas arranca el motor. Con motor arrancado, apretándolo de nuevo, se seleccionan las funciones de la pantalla.

Palanca arranque en frío del motor (Choke)

Gire en sentido horario para el arranque en frío del motor. Pasados algunos segundos lleve la palanca a su posición inicial.

Mando acelerador

Girar para regular la alimentación del motor.

Palanca freno delantero

Acercarse a la manecilla para accionar el freno delantero.

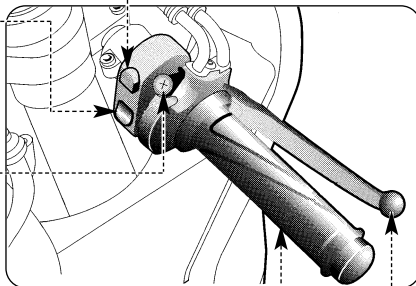

**Interruptor Parada Motor**

Esta función permite parar el motor en caso de emergencia; de ésta manera se desactiva el circuito de encendido impidiendo el arranque del motor. Para poder efectuar el arranque colocar nuevamente el pulsador en posición de descanso.

NOTA

En condiciones normales no utilizar éste dispositivo para parar el motor.

Pulsador Puesta en marcha del Motor

Este dispositivo permite la puesta en marcha del motor; además con el motor en marcha permite seleccionar las funciones del display presente en la instrumentación de a bordo.

**PRUDENCIA - PRECAUCION**

Para evitar daños a la instalación eléctrica no tener presionado el pulsador por mas de 5 segundos consecutivos.

Si el motor no arranca después de varios tentativos, consultar el capítulo “AVERÍAS” en éste manual.

Leva Puesta en marcha en frío del Motor (Choke)

El dispositivo facilita el arranque en frío actuando en la alimentación.

NOTA

Esta función debe estar activa por un tiempo limitado y de cualquier manera dependiendo de la temperatura del motor y del ambiente externo. Cuando el régimen de ralentí es suficiente para mantener prendido el motor, es oportuno desactivar el mando.



Mando Acelerador

Este dispositivo permite regular la alimentación del motor variando el régimen de rotación. Para accionar el dispositivo es necesario girar la manecilla en la posición de descanso, que corresponde al régimen de ralentí del motor.

Arrancando en frío (Choke activo), la rotación repetida de la manecilla hacia el cierre del gas permite retornar la leva del choke en posición de descanso.

Palanca Freno Delantero

Este mando permite accionar a través de un circuito hidráulico la instalación de frenos de la rueda delantera.



3.5. Interruptor de encendido y bloqueo del manillar

**PELIGRO**

No colocar llaveros u otros objetos en la llave de encendido para no crear obstáculos en la rotación de la dirección.

**PELIGRO**

No intentar cambiar la posición del interruptor durante la marcha; se podría perder el control del vehículo.

El interruptor de encendido activa y desactiva el circuito eléctrico y el bloqueo del manillar; las cuatro posiciones de mando se describen a continuación.

Posición "OFF"

Todos los circuitos eléctricos están desactivados. Se puede extraer la llave.

Posición "ON"

Todos los circuitos eléctricos están activados, los instrumentos y los testigos efectúan el autodiagnóstico; se puede arrancar el motor. La llave no se puede extraer.

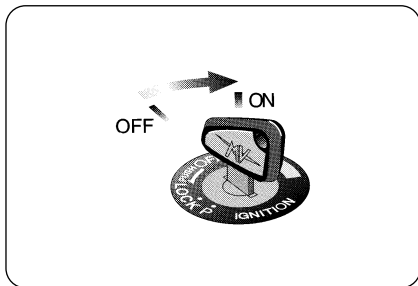
**PRUDENCIA - PRECAUCION**

No dejar la llave en la posición de "ON" por mucho tiempo con el motor apagado, para no dañar los componentes eléctricos de la motocicleta.

**Posición “LOCK”**

Gire el manillar a la derecha o a la izquierda. Empujar levemente la llave y al mismo tiempo girarla en posición “LOCK”.

Todos los circuitos eléctricos están desactivados y el manillar está bloqueado. Se puede extraer la llave.

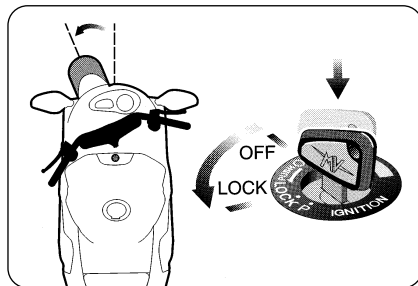
**3 ES****Posición “P”**

Gire la llave de la posición “LOCK” a la posición “P”. Todos los circuitos eléctricos están desactivados excepto las luces de estacionamiento (luces de posición) y el manillar está bloqueado. Se puede extraer la llave.

**PRUDENCIA - PRECAUCION**

No dejar la llave en posición “P” por mucho tiempo, para evitar descargar la batería de la motocicleta.

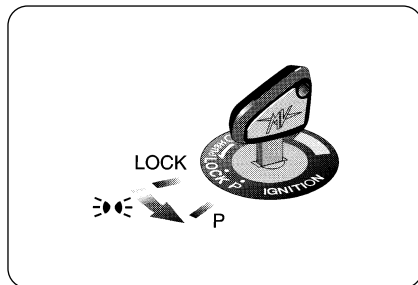



3.6. Mando cambio

La posición **N** "Neutral" corresponde a la posición de punto muerto señalada por el correspondiente testigo en el cuadro mandos.

Desplazando la palanca del cambio hacia abajo se engrana la primera velocidad.

De igual manera, desplazando la palanca hacia arriba se engrana la segunda; continuando varias veces a desplazar la palanca hacia arriba se engranan, en secuencia, todas las demás velocidades hasta la sexta.

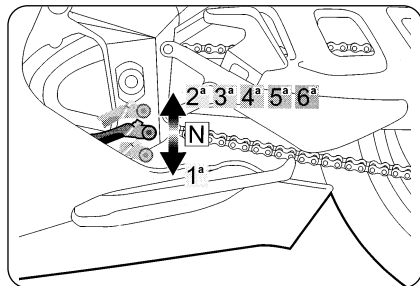



3.7. Instrumentos y testigos

Los instrumentos y los testigos se activan girando la llave de encendido en posición "ON". Después de un check-up inicial (~7 segundos) la información que aparece corresponde a las condiciones generales de la motocicleta en ese momento.

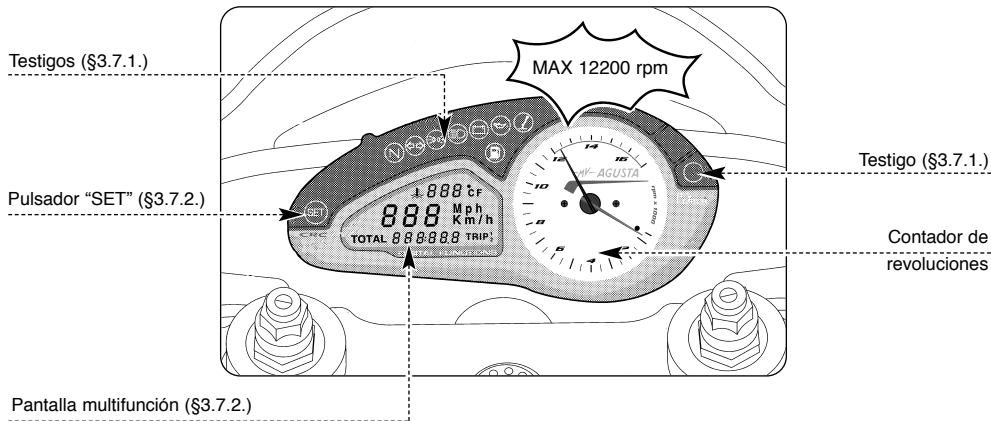



3.7.1. Testigos

Testigo luz carretera (azul)

Se enciende cuando está activada la luz de carretera.

Testigo carga batería (rojo)

Se enciende cuando el alternador no proporciona la corriente eléctrica suficiente para cargar la batería.

Si el encendido se produce durante la circulación diríjase a un centro de asistencia autorizado.

Testigo luz de cruce (verde)

Se enciende cuando está activada la luz de cruce.

Testigo apertura caballete lateral (rojo)

Se enciende cuando el caballete está bajado.

Testigo cambio en punto muerto (verde)

Se enciende cuando el cambio está en la posición punto muerto "Neutral".

Testigo limitador de revoluciones (rojo)

Se enciende cuando el motor supera las 12200 rpm; el limitador interviene a 13000 rpm.

Testigo indicadores de dirección (verde)

Se enciende cuando están activados los indicadores de dirección.

Testigo reserva combustible (naranja)

Se enciende cuando en el depósito hay aproximadamente cuatro litros de combustible.

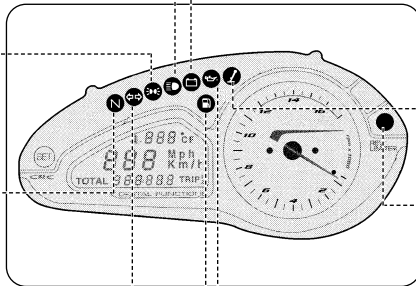

Testigo presión aceite motor (rojo)

Se enciende cuando el aceite está a una presión insuficiente.



Peligro-Atención: Si se enciende durante la circulación, deténgase inmediatamente, controle el nivel del aceite y si es necesario hace efectuar el relleno por un centro de asistencia autorizado MV Agusta (ver §3.8.). Si el testigo se enciende a pesar de que el nivel es correcto, no siga circulando y póngase en contacto con un centro de asistencia autorizado MV Agusta.



3.7.2. Pantalla multifunción

Velocímetro

Indica la velocidad. El valor puede aparecer en kilómetros por hora (km/h) o bien en millas por hora (Mph). El valor máximo es de 350 Km/h (218 Mph).

Pulsador "SET"

Si se aprieta, permite seleccionar las cifras de la pantalla para efectuar las regulaciones. Si se aprieta nuevamente permite confirmar las cifras introducidas.

Si es apretado junto al pulsador de arranque del motor, permite iniciar la función de cronómetro.

Cuentakilómetros total "TOTAL"

Indica el recorrido total, de 0 a 99999,9 (km o mi)

Cuentakilómetros parcial 1 "TRIP 1"

Indica el recorrido parcial, de 0 a 9999,9 (km o mi)

Cuentakilómetros parcial 2 "TRIP 2"

Indica el recorrido parcial, de 0 a 9999,9 (km o mi)

Reloj

Indica la hora (0÷24).

Termómetro

Indica la temperatura del líquido de refrigeración. El valor puede aparecer en grados centígrados (°C) o bien en grados Fahrenheit (°F).

El campo de indicación está comprendido entre 40° y 140° C (104° y 284°F):

- por debajo de 40°C (104°F) la indicación no aparece pero aparecen tres líneas que centellean; es la señal de temperatura muy baja;
- entre 40° y 49°C (104° y 120°F) la indicación centellea, es la señal de temperatura baja;
- entre 50° y 111°C (122° y 232°F) la indicación es fija;
- entre 112° y 140°C (234° y 284°F) la indicación centellea; es la señal de temperatura alta.

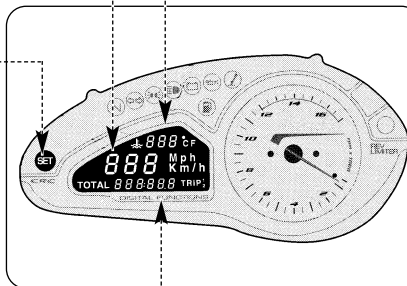

Peligro - Atención: si la temperatura supera los 120°C (248°F) detenga la motocicleta, controle el nivel del líquido de refrigeración. En el caso fuera necesario llenar, póngase en contacto con un centro de asistencia autorizado MV Agusta (ver § 3.8.). Si el testigo se enciende a pesar de que el nivel es el correcto, no siga circulando y póngase en contacto con un centro de asistencia autorizado MV Agusta.



3.8. Tabla lubricantes y líquidos

Descripción	Producto aconsejado	Características
Aceite lubricación motor	AGIP RACING 4T 10W/60 (*)	SAE 10W/60 - API SJ
Líquido de refrigeración	AGIP ECO - PERMANENT	Glicol - Etilénico diluido con 50% de agua destilada
Fluido mando embrague y frenos	AGIP BRAKE FLUID DOT4	DOT4
Aceite lubricación cadena	MOTUL CHAIN LUBE ROAD	-

* : Para encontrar fácilmente los productos recomendados, MV Agusta aconseja dirigirse directamente a los propios concesionarios autorizados. El aceite para motor AGIP Racing 4T 10W/60 ha sido realizado especialmente para el motor de la motocicleta F4. En el caso que el lubricante descrito no se consiga, MV Agusta aconseja utilizar aceites completamente sintéticos con características conformes o superiores a las siguientes normas:

- Conforme API SJ
- Conforme ACEA A3
- Conforme JASO MA
- Gradación SAE 20 W-50 o 10 W-60

NOTA

Las especificaciones indicadas deben estar presentes, por sí solas o junto a otras, en el envase del aceite lubricante.





4.1. Uso de la motocicleta

En esta sección se exponen los principales temas para el correcto uso de la motocicleta.



ATENCIÓN

Su motocicleta tiene altas características de potencia y prestaciones; por lo tanto, para su utilización es necesario un adecuado nivel de conocimiento del vehículo. Cuando usted utiliza la motocicleta para la primera vez, es necesario adoptar una actitud prudente. Una agresiva o temeraria actitud de conducción podría aumentar el peligro de accidentes y comportar un grave peligro para su incolumidad o para la de otras personas.



ATENCIÓN

LAS RESTRICCIONES DE USO DEL VEHÍCULO ESTÁN INDICADAS EN LA SECCIÓN “INFORMACIÓN PARA LA SEGURIDAD”.



PRUDENCIA

Las altas temperaturas causadas por el uso del vehículo en los circuitos podían comprometer la eficacia del convertidor catalítico y del dispositivo de escape; por lo tanto, sugerimos montar un dispositivo especial de escape al usar el vehículo en los circuitos.



4.2. Rodaje



Prudencia - Precaución: el incumplimiento de las indicaciones a continuación indicadas puede perjudicar la duración y las prestaciones de la motocicleta.

Es muy común considerar el rodaje como una fase aplicada sólo al motor. En realidad el rodaje es importante también para otras partes primordiales de la moto como son los neumáticos, los frenos, la cadena de transmisión, etc. Durante los primeros kilómetros adopte una conducción tranquila.

De 0 a 500 km (de 0 a 300 mi) (A)

Durante este recorrido varíe frecuentemente el régimen de rotación del motor. Si es posible, efectúe trayectos con colinas, con muchas curvas y evite largos tramos rectilíneos.

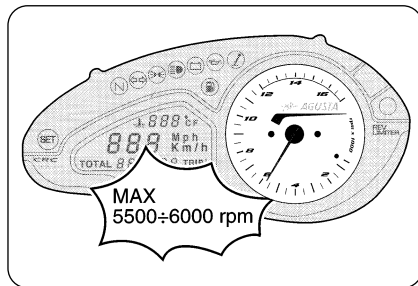

PELIGRO

Los neumáticos nuevos deben ser sometidos a un adecuado rodaje para alcanzar la completa eficiencia. Evitar acelerar, curvas y frenadas bruscas en los primeros 100 km. Si no se realiza un primer periodo de rodaje de los neumáticos, hay riesgo de resbalar o perder el control del vehículo con consiguiente peligro de accidentes.



❑ **De 500 a 1000 km (de 300 a 600 mi)**

Durante este recorrido evite mantener mucho tiempo el motor bajo esfuerzo.

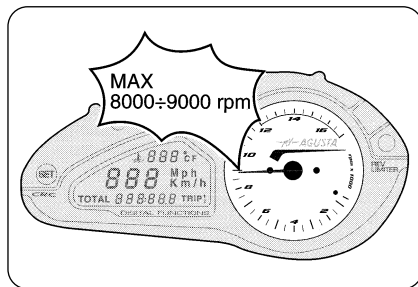

❑ **De 1000 a 2500 km (de 600 a 1600 mi)**

Durante este recorrido es posible pretender mayores prestaciones al motor pero sin superar el régimen de rotación indicado.

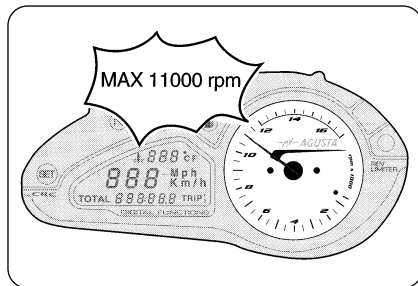



4.3. Arranque motor



PELIGRO

Dejar el motor prendido en un ambiente cerrado puede ser peligroso. Los gases de escape contienen monóxido carbónico, un tipo de gas sin color y sin olor que puede provocar la muerte o graves infortunios. Dejar funcionar el motor solo externamente.

► Girando el interruptor de encendido en posición "ON"; la instrumentación y las luces testigo efectúan el auto-diagnóstico; durante ésta fase, asegurarse que todas las luces testigo en el tablero se enciendan. Para que el sistema de interrupción del circuito de encendido del consentimiento al arranque, se debe haber dado una de las siguientes condiciones:

- El cambio en posición de neutro.
- El cambio se encuentra engranado en una marcha con la palanca del embrague accionada y el caballete lateral levantado.

❑ Arranque en frío

► Gire la palanca "CHOKE", sin girar la maneta del acelerador y presione el pulsador.

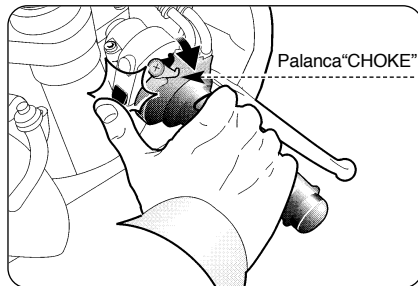



► Enseguida que el motor se pone en marcha, soltar el pulsador y después de un breve calentamiento retornar la leva en la posición inicial.

❑ **Arranque en caliente**

- Apriete el pulsador sin girar la maneta del acelerador.
- Apenas el motor arranca, suelte el pulsador.



Prudencia - Precaución:

- Para evitar daños a la instalación eléctrica no se debe accionar el arranque por mas de 5 segundos consecutivos.
- No dejar el motor en marcha por mucho tiempo con la moto parada. El consiguiente recalentamiento puede dañar los componentes internos del motor. Es preferible llevar el motor a la temperatura de ejercicio saliendo a una a baja velocidad.
- Para prolongar al máximo la durabilidad del motor, no acelerar a fondo cuando el motor está frío.

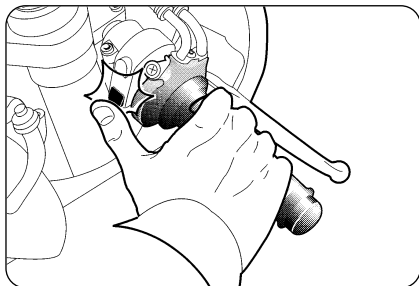



4.4. Selección y modificación de las funciones display

La instrumentación prevé la posibilidad de intervención en algunos de los parámetros principales de medición e iniciar la función cronómetro.

Las operaciones posibles son:

- Selección de las funciones:

Cuentakilómetros	Total	"TOTAL"
Cuentakilómetros	Parcial 1	"TRIP 1"
Cuentakilómetros	Parcial 2	"TRIP 2"
Reloj		
Cronómetro		

- Ajuste de la unidad de medida relativa a:

Velocidad
Distancia recorrida
Temperatura

- Anulación de las funciones cuentakilómetros parciales:

Cuentakilómetros	Parcial 1	"TRIP 1"
Cuentakilómetros	Parcial 2	"TRIP 2"

- Ajuste de la función reloj

- Poner en función cronómetro

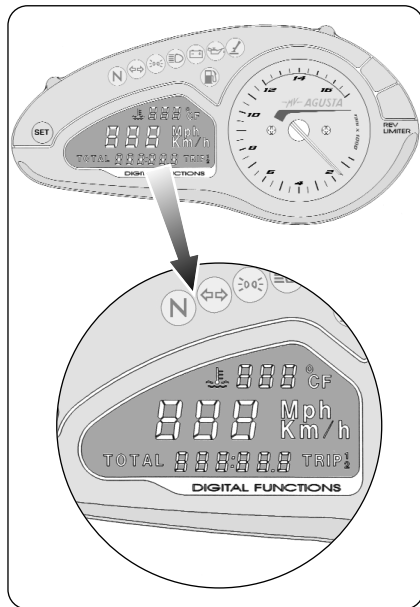



4.4.1. Selección de las funciones de la pantalla

La selección corresponde a las funciones:

- Cuantakilómetros Total "TOTAL"
- Cuantakilómetros parcial 1 "TRIP 1"
- Cuantakilómetros parcial 2 "TRIP 2"
- Reloj
- Cronómetro

► La representación visual de las funciones "TOTAL", "TRIP 1" y "TRIP 2", se realiza presionando el pulsador de arranque del motor. Actuando en éste pulsador aparecen en el display las funciones en modo cíclico. Seleccionar las funciones deseadas.

► La representación visual de las funciones cronómetro está ilustradas en la página siguiente.

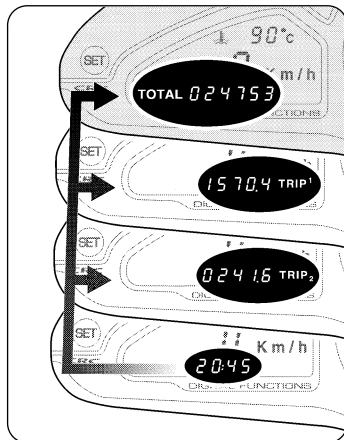
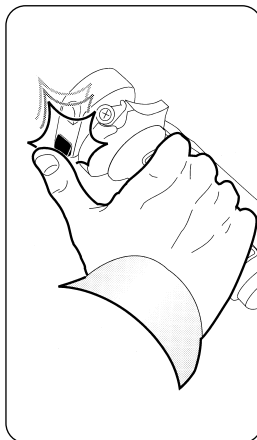

4 ES



PELIGRO

Las operaciones de modificación o ajuste de las funciones del display se deben realizar con motor encendido, cambio en neutro, motocicleta parada y los pies en el suelo.

Está prohibido ajustar el display durante la marcha.



❑ Cronómetro

► La activación del cronómetro es posible solo si en el display aparece una de las siguientes funciones:

- Cuentakilómetros Total "TOTAL"
- Cuentakilómetros Parcial 1 "TRIP 1"
- Cuentakilómetros Parcial 2 "TRIP 2"
- Reloj

► Apretar al mismo tiempo el pulsador "SET" y el pulsador de arranque del motor por al menos 2 segundos.

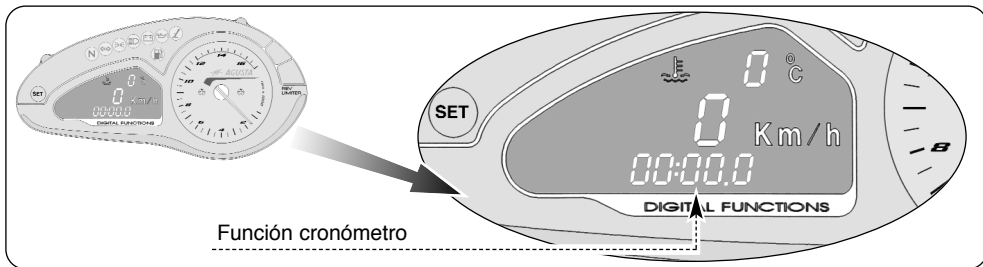
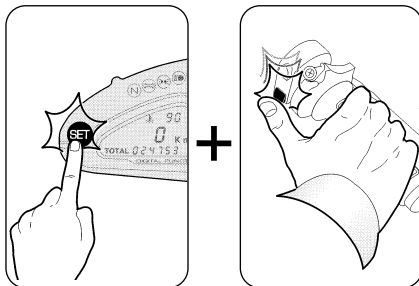

El funcionamiento del cronómetro está ilustrado en los párrafos sucesivos (§ 4.4.5).



4.4.2. Ajuste de la unidad de medida

Es posible efectuar la modificación de la unidad de medida.



PELIGRO

Las operaciones de modificación o regulación de las funciones display se deben realizar con el motor en marcha, cambio de velocidades en neutro, motocicleta parada y los pies en el suelo. Está prohibido realizar las regulaciones en el display durante la marcha.

❑ Velocímetro (km/h - Mph)

- ▶ Apretar varias veces el pulsador de puesta en marcha del motor hasta que aparezca la función del cuentakilómetros total "TOTAL".
- ▶ Apriete el pulsador "SET", la unidad de medida del velocímetro empieza a centellear.

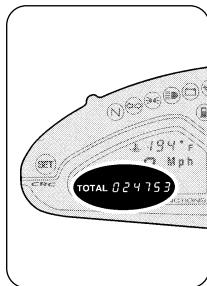
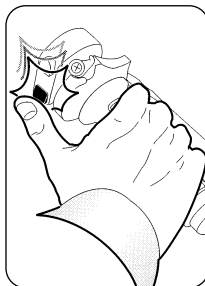

4 ES

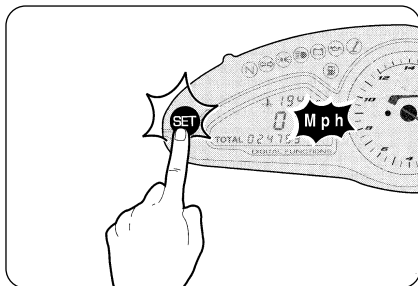



► Apretar el pulsador de puesta en marcha del motor para pasar de km/h a Mph o viceversa. Variando la unidad de medida del velocímetro, también varía automáticamente la del cuentakilómetros (total o parcial).

Recordamos que 1 mi = 1,609 Km.

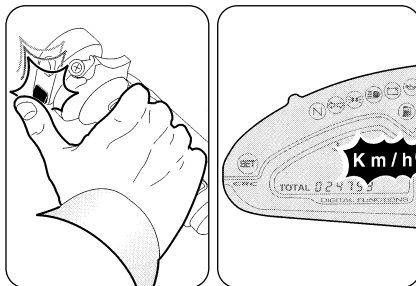

► Apriete el pulsador “SET”; la unidad de medida del velocímetro queda confirmada y la unidad de medida del termómetro empieza a centellear. Se puede efectuar la siguiente regulación.

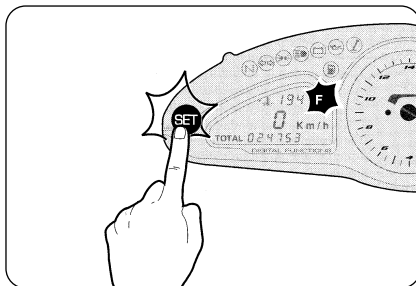



❑ Termómetro (° C - ° F)

▶ Apretar el pulsador de puesta en marcha del motor para pasar de °C a °F o viceversa.

Recordamos que $T (^{\circ}\text{F}) = 1,8 \cdot t (^{\circ}\text{C}) + 32$

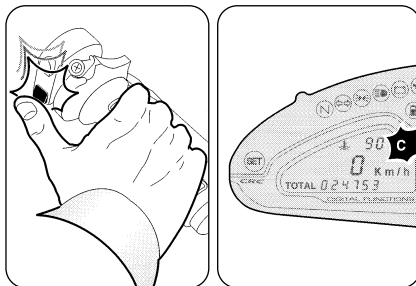

▶ Apriete el pulsador "SET" para confirmar la unidad de medida.

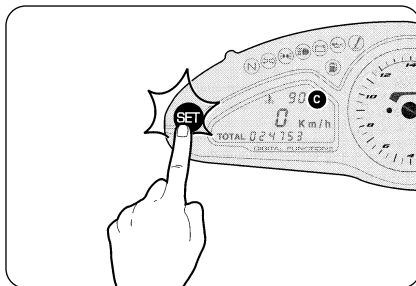



4.4.3. Anulación de las funciones cuentakilómetros parciales

Los valores de las funciones “TRIP1” y “TRIP2” se pueden ajustar a cero de la siguiente manera.



PELIGRO

Las operaciones de modificación o ajuste de las funciones del display se deben realizar con motor encendido, cambio en neutro, motocicleta parada y los pies en el suelo. Está prohibido ajustar el display durante la marcha.

► Presionando el pulsador de arranque del motor activar la función “TRIP 1”.

► Presionar el pulsador de arranque del motor por más de cuatro segundos; el valor “TRIP 1” comienza a destellar.

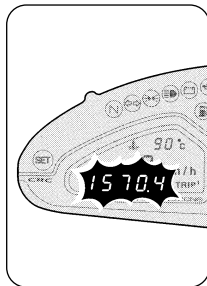
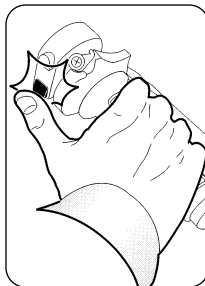
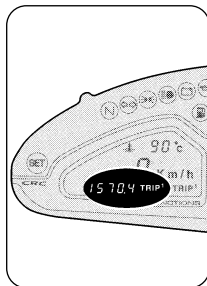
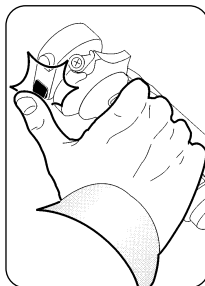



► Presionando ahora el pulsador de arranque del motor por menos de cuatro segundos el valor va a cero. Si en cambio se presiona el pulsador de arranque del motor por más de cuatro segundos el proceso de reseteo se interrumpe.

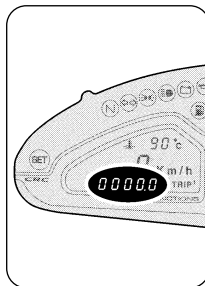
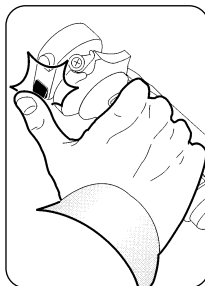

► Apretando el pulsador de arranque del motor activar la función "TRIP 2".

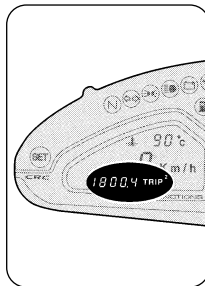
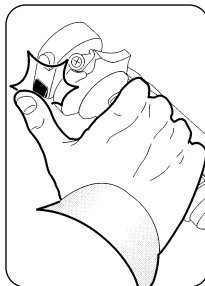



► Presionar el pulsador de arranque del motor por mas de cuatro segundos; el valor “TRIP 2” comienza a destellar.

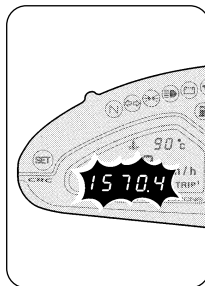
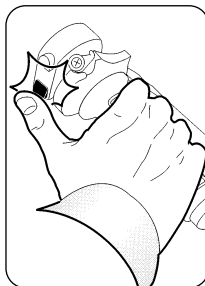

► Presionando ahora el pulsador de arranque del motor por manos de cuatro segundos el valor va a cero. Si en cambio se presiona el pulsador de arranque del motor por mas de cuatro segundos el proceso de reseteo se interrumpe.

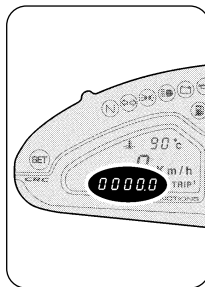
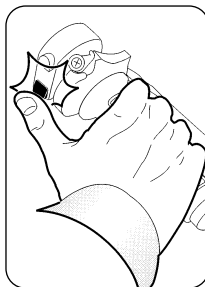



4.4.4. Ajuste de la función reloj

Es posible efectuar el ajuste de la función reloj.



PELIGRO

Las operaciones de modificación o ajuste de las funciones del display se deben realizar con motor encendido, cambio en neutro, motocicleta parada y los pies en el suelo. Está prohibido ajustar el display durante la marcha.

- ▶ Presionar varias veces el pulsador de arranque del motor hasta que aparece la función del reloj.
- ▶ Apriete el pulsador "SET"; la primera cifra de la hora empieza a centellear.

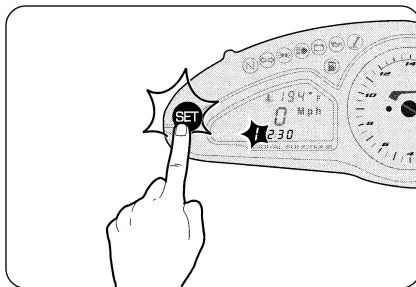
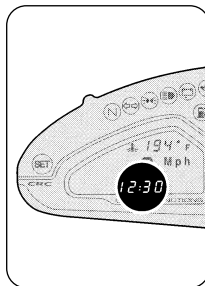
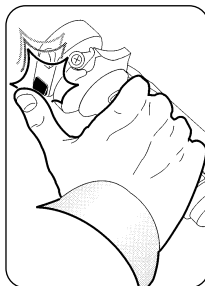



► Presionar el pulsador de arranque del motor para ajustar la cifra; dejar apenas aparezca la cifra deseada.

NOTA

Para que las cifras pasen rápidamente tener presionado el pulsador de arranque del motor por mas de dos segundos.

► Apretar el pulsador “SET” para confirmar y para proceder con el ajuste de la cifra sucesiva.

► Repetir el procedimiento para el ajuste de la segunda cifra de la hora, la primera y la segunda cifra de los minutos.

► Apretar el pulsador “SET” para confirmar el ajuste de la hora y para interrumpir la selección (el destello).

NOTA

La instrumentación dispone de una memoria integral que conserva todos los parámetros también con el motor apagado. Con excepción del reloj, el cual se anula, todos los demás parámetros quedan en la memoria aún desconectando la batería.

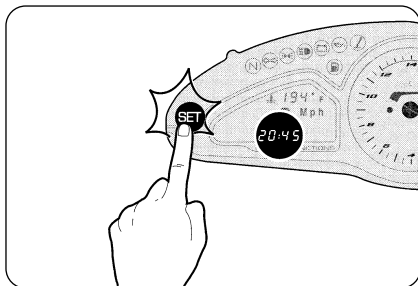
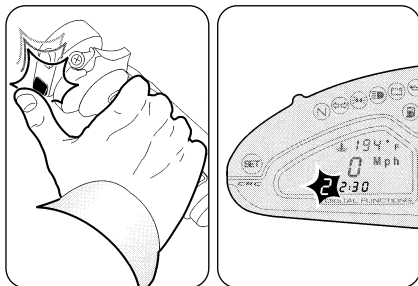



4.4.5. Cronómetro

► La activación del cronómetro es posible solo si en el display aparece una de las siguientes funciones:

- Cuentalómetros Total "TOTAL"
- Cuentalómetros Parcial 1 "TRIP 1"
- Cuentalómetros Parcial 2 "TRIP 2"
- Reloj

► Apretar al mismo tiempo el pulsador "SET" y el pulsador de arranque del motor por al menos 2 segundos. De ésta manera se inicia la función cronómetro. En el display aparece la cifra "00:00:0".



PELIGRO

Las operaciones de modificación o regulación de las funciones display se deben realizar con el motor en marcha, cambio de velocidades en neutro, motocicleta parada y los pies en el suelo. Está prohibido realizar las regulaciones en el display durante la marcha.

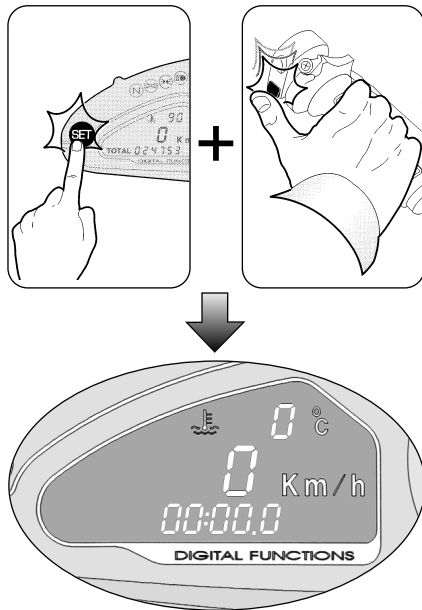



❑ Adquisición Datos

Después de haber activado la función cronómetro es posible iniciar la adquisición de datos accionando el pulsador del destello luz de carretera. La ejecución de dicha operación determina el inicio de la medición del tiempo. Los puntos que separan los minutos de los segundos y décimas de segundos inician a destellar. El instrumento está adquiriendo los tiempos.

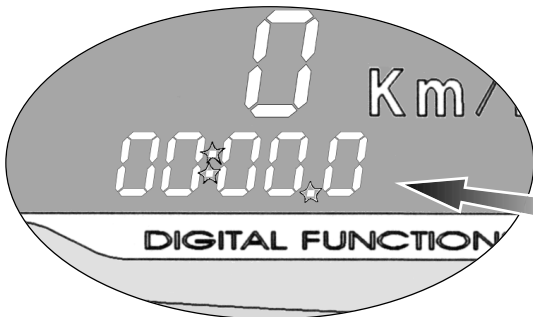
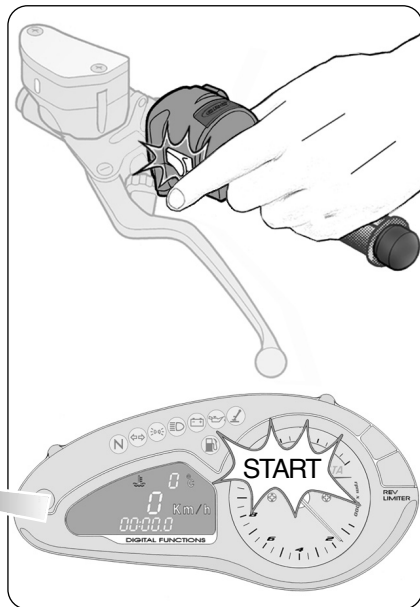



Apretando nuevamente el pulsador del destello luz de carretera es registrada la medición del tiempo correspondiente a la 1ª vuelta recorrida. Al mismo tiempo el instrumento inicia a adquirir el tiempo correspondiente a la segunda vuelta.

La medición del tiempo correspondiente a la primera vuelta es conservado en la memoria y queda representada en el display hasta la adquisición de la siguiente vuelta.

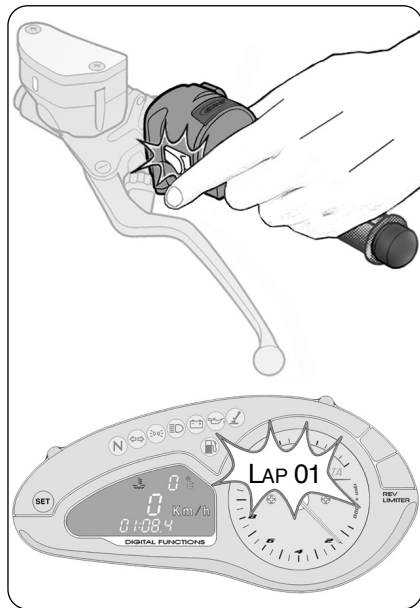



Si se continúa a utilizar el cronómetro, cada vez que accionamos el pulsador de destello es registrado un tiempo.

El instrumento tiene la capacidad para realizar máximo 80 memorizaciones consecutivas.

En el caso que el tiempo de la vuelta apenas anotado haya sido inferior al tiempo medido durante la vuelta precedente, el instrumento visualiza el símbolo “ - ” delante de la cifra.

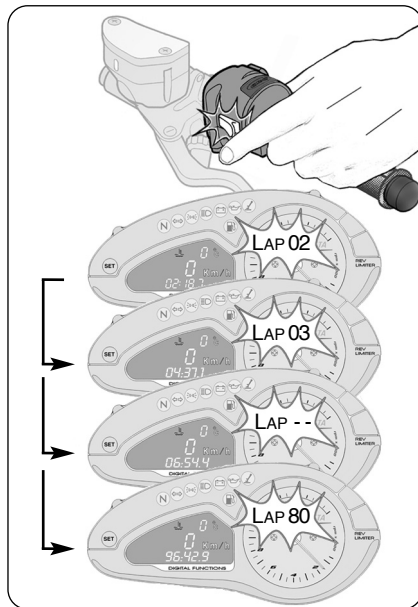
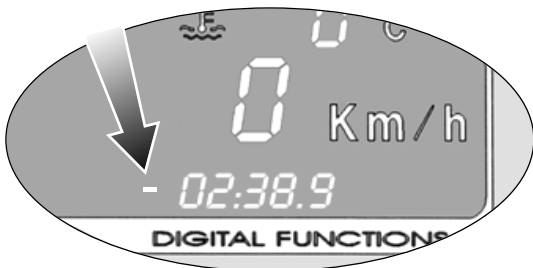



□ Representación visual de datos

Una vez acabada la fase de adquisición tiempos es posible ver los datos representados.

NOTA

Tener cuidado en no apagar el motor. En la eventualidad de que el motor se apague los datos memorizados se perderían.

► Apretar el pulsador SET por un tiempo comprendido entre 0,25 y 2 segundos.

NOTA

Apretando el pulsador SET por un tiempo superior a 2 segundos se anulan todos los datos en la memoria.

► En el display aparece la indicación "LAP 01"; después de 1 segundo aparece el tiempo correspondiente a la 1ª vuelta en la memoria.

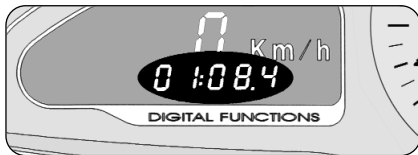
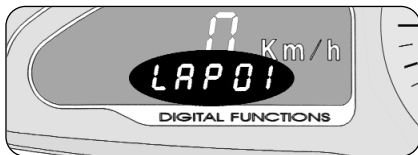
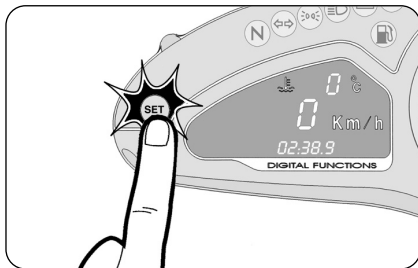



► Accionando el pulsador del destello luces de carretera, en el display aparece la indicación "LAP 02"; después de 1 segundo aparece el tiempo correspondiente a la 2ª vuelta en la memoria.

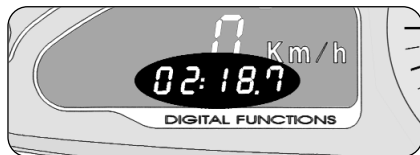
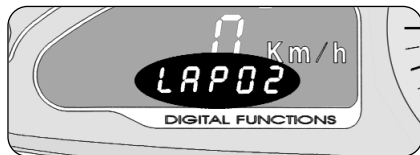

► Si seguimos apretando el pulsador de destello, van apareciendo los datos de las vueltas sucesivas. Después de la representación de los datos de la última vuelta en memoria, apretando nuevamente el pulsador de destello retornamos a la representación visual de los datos de la 1ª vuelta ("LAP 01").



□ Representación visual de los datos de la vuelta más veloz

- ▶ Comprobar que el display se encuentre en la modalidad de representación visual datos, y que en él aparezca el tiempo correspondiente a la 1ª vuelta en la memoria (“LAP 01”).
- ▶ Apretar el pulsador “SET” por 2 segundos o más.

NOTA

Apretando el pulsador “SET” por menos de 2 segundos, salimos de la modalidad representación visual datos.

- ▶ En el display aparece el número de la vuelta en el cual ha sido realizado el mejor tiempo; después de 1 segundo aparece el tiempo correspondiente.

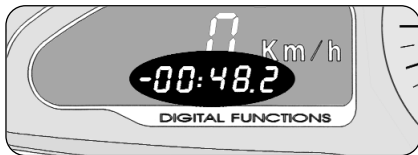
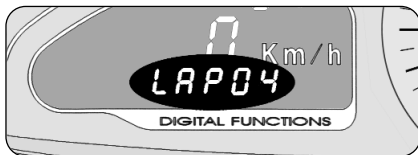
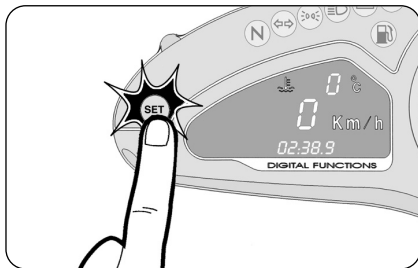



❑ Retorno a la modalidad adquisición datos

▶ Apretando el pulsador “SET” por un tiempo comprendido entre 0,25 y 2 segundos, retornamos a la modalidad de adquisición datos; de ésta manera es posible seguir adquiriendo tiempos, o comenzar una sesión de cronometraje.

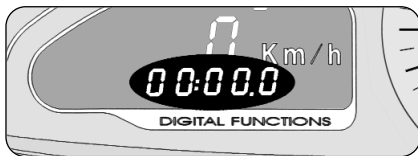
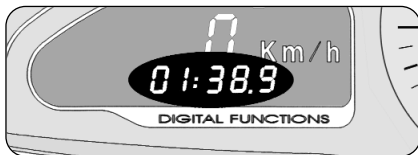
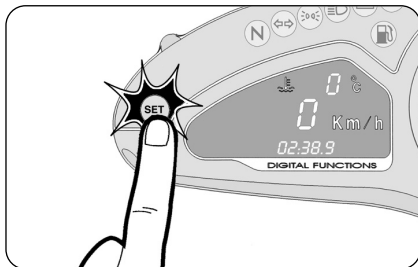

▶ Después de haber apretado el pulsador “SET”, en el display aparecen los datos correspondientes a la última vuelta en la memoria.

NOTA

Retornando a la modalidad adquisición datos, si anteriormente no ha sido memorizado ningún dato, en el display aparecerá la indicación “00:00.0”.



❑ Borrado de datos

Para borrar todos los datos en la memoria se debe apretar por 2 segundos el pulsador "SET".

NOTA

Los datos borrados no se pueden recuperar. La operación de limpieza de datos se puede realizar también con el cronometro activo. En ésta condición se interrumpe la operación de cronometraje.

Después del borrado en el cronometro aparece la indicación "00:00.0".

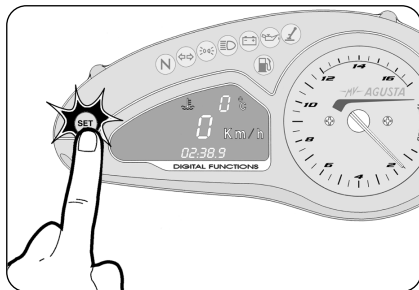

4 ES

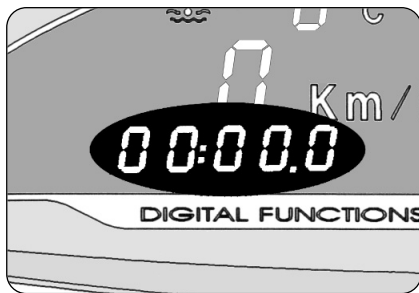



4.5. Reabastecimiento combustible



Peligro – Atención: la gasolina y sus vapores son extremadamente inflamables y dañosos.

Evitar el contacto y la inhalación.

Durante el abastecimiento apagar el motor, no fumar, tener lejos llamas, chispas y fuentes de calor. Efectuar el llenado en un lugar abierto o en un sitio bien ventilado.



Prudencia – Precaución: utilizar exclusivamente gasolina super sin plomo con 95 octanos (R.O.N.) o mas. Esta necesidad es recordada por un punto verde en la parte inferior de la tapa del deposito.

- ▶ Levante la tapa parapolvo.
- ▶ Introduzca la llave, gírela en sentido horario y levante el tapón.
- ▶ Después del abastecimiento presione el tapón hacia abajo girando contemporáneamente la llave en sentido horario para facilitar el cierre. Suelte la llave y extráigala.

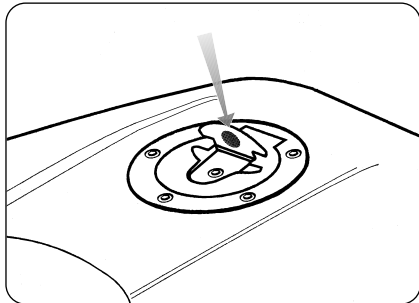
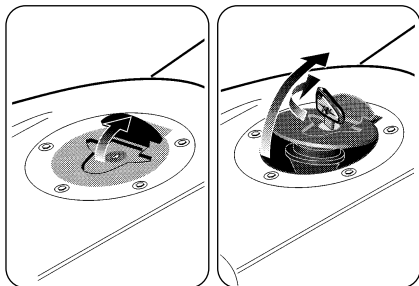

**PELIGRO**

Llenando excesivamente el depósito puede provocar derrame del carburante debido a la expansión del calor provocada por el calor del motor o a la exposición de la motocicleta a la luz del sol. Eventual derrame de carburante puede provocar incendios. El nivel del carburante en el depósito no debe superar nunca la base de la boca de llenado.



Prudencia - Precaución: secar enseguida con un trapo limpio eventual carburante derramado, puesto que podría dañar la superficie pintada o de plástico.

**PELIGRO**

Verificar que la tapa del depósito del carburante esté cerrada correctamente antes de utilizar el vehículo.

4 ES

4.6. Acceso al hueco portaobjetos

- ▶ Introduzca la llave.
- ▶ Presionar la cola en la parte terminal y al mismo tiempo girar la llave hacia la derecha.
- ▶ Levantar levemente la cola en la extremidad trasera; dejarlo deslizar hacia atrás y levantarlo completamente hasta que toque el depósito del carburante.

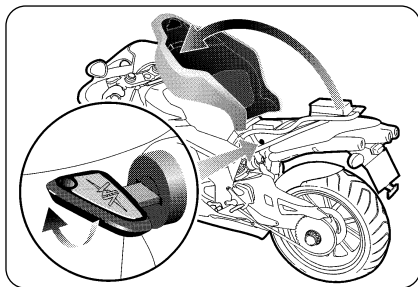



4.7. Estacionamiento de la motocicleta

❑ Estacionamiento con caballete lateral



PRUDENCIA – PRECAUCION

- Aparcar la motocicleta en condiciones de seguridad y en un terreno estable.
- En las pendientes estacionar la moto con la rueda delantera hacia la subida y con la primera velocidad engranada; recordarse de retornar el cambio en neutro antes de poner en marcha el vehículo.
- No dejar el vehículo sin custodia con la llave de encendido introducida en el cuadro.

- ▶ Bajar el caballete con el pié hasta el tope e inclinar lentamente la motocicleta para colocar el pié de apoyo a contacto con el suelo.

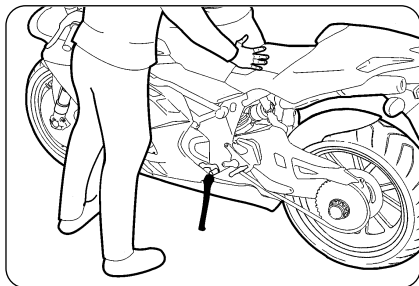

**PELIGRO**

Cuando el vehículo esté parado sobre el caballete lateral, es peligroso sentarse sobre él cargando todo el peso sobre el único apoyo de estacionamiento.

**PELIGRO**

Antes de ponerse en marcha verificar el buen funcionamiento del interruptor de seguridad cerciorandose que la luz testigo del caballete lateral ubicada en el tablero se apague; de todas maneras verificar que el caballete lateral haya retornado.

Si se nota una imperfección, hacer controlar la instalación por un concesionario MV Agusta antes de utilizar el vehículo.

□ Estacionamiento con caballete trasero

Introducir el perno del caballete en el orificio del eje de la rueda trasera en el lado izquierdo de la moto; apoyar el caballete en el suelo y empujándolo, levantar el vehículo hasta que el vehículo esté estable.

**PRUDENCIA - PRECAUCION**

Esta operación se debe realizar por dos personas.

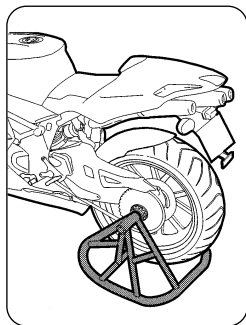
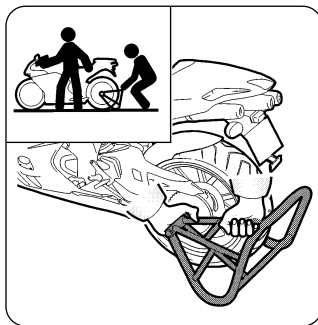



5.1. Lista regulaciones

La motocicleta posee una amplia posibilidad de regulaciones que pueden mejorar la ergonomía, la estabilidad y la seguridad.

Sin embargo algunas de estas regulaciones pueden ser realizadas exclusivamente por los Centros de Asistencia MV Agusta, dado que una regulación errónea de ciertos componentes sumamente importantes puede provocar una situación de peligro.



PELIGRO

Las regulaciones se deben realizar con el vehículo parado.



(F) Regulación espejo retrovisor (§5.5.)

(A) Regulación palanca embrague (§5.4.)

(F) Regulación espejo retrovisor (§5.5.)

(C) Ajuste reposapiés derecho (§5.2.)

(E) Regulación palanca freno trasero (§5.2.)

(B) Regulación palanca freno delantero (§5.3.)

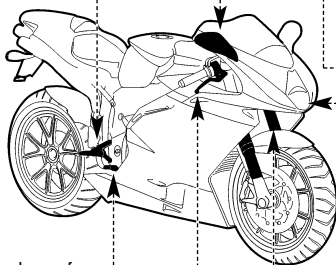

(G) Regulación amortiguador de dirección (§5.6.)

(D) Regulación palanca cambio (§5.2.)

(L) Regulación suspensión trasera (§5.8.)

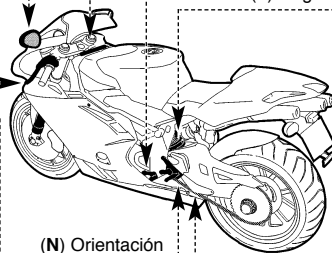

(N) Orientación faro (§5.9.)

(M) Regulación cadena (§5.2.)

(C) Ajuste reposapiés izquierdo (§5.2.)

(H) Regulación suspensión delantera (§5.7.)



5.2. Tabla de las regulaciones



A - Regulación palanca embrague: para optimizar el funcionamiento según las exigencias del motociclista (§5.4).



B - Regulación palanca freno delantero: para optimizar el funcionamiento según las exigencias del motociclista (§5.3).



C - Ajuste reposapiés (derecho e izquierdo): para colocar el reposapiés de la manera más conveniente según las exigencias del conductor.



D - Regulación palanca cambio: para optimizar el movimiento del mando en función de las exigencias del motociclista.



E - Regulación palanca freno trasero: para optimizar el movimiento de los mandos en función de las exigencias del motociclista.



F - Regulación espejos retrovisores: para optimizar la orientación (§5.5).



G - Regulación amortiguador de dirección: para adaptar la dureza del manillar a las preferencias del motociclista (§5.6).



H - Regulación suspensión delantera: para adaptar su respuesta a las preferencias del motociclista se pueden regular:

- precarga muelle (§5.7.1.)
- dispositivo hidráulico de frenado en extensión (§5.7.2.)
- dispositivo hidráulico de frenado en compresión (§5.7.3.)



L - Regulación suspensión trasera: para adaptar su respuesta a las preferencias del motociclista se pueden regular:

- altura rectificado
- precarga muelle (§5.8.1.)
- dispositivo hidráulico de frenado en extensión (§5.8.2.)
- dispositivo hidráulico de frenado en compresión para alta velocidad (§5.8.3.)
- dispositivo hidráulico de frenado en compresión para baja velocidad (§5.8.4.)



M - Regulación cadena: para la eficacia y la seguridad de la transmisión.



N - Orientación faro: para optimizar la profundidad del haz luminoso en función del equilibrado (§5.9).



5.3. Regulación de la palanca del freno delantero

Tire de la palanca para neutralizar el empuje del muelle y, contemporáneamente, ajuste la posición girando la virola en sentido horario o contrario a las agujas del reloj. En sentido horario: la palanca se aleja de la maneta. En sentido contrario a las agujas del reloj: la palanca se acerca a la maneta.

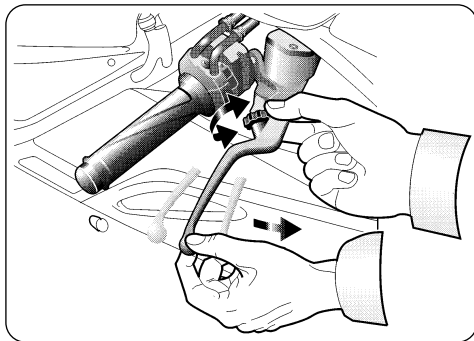

5.4. Regulación de la palanca del embrague

Tire de la palanca para neutralizar el empuje del muelle y, contemporáneamente, ajuste la posición girando la virola en sentido horario o contrario a las agujas del reloj. En sentido horario: la palanca se aleja de la maneta. En sentido contrario a las agujas del reloj: la palanca se acerca a la maneta.

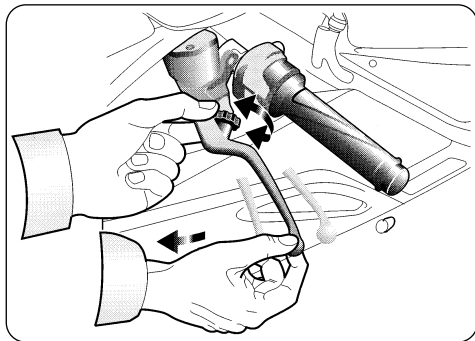



5.5. Regulación de los espejos retrovisores

Apriete los puntos puestos en evidencia para regular la posición en las cuatro direcciones.

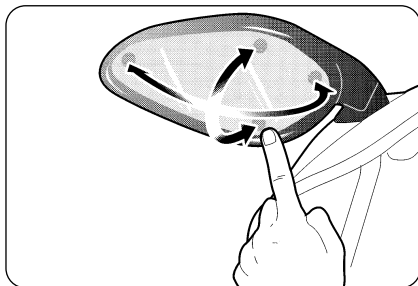

5

5.6. Regulación del amortiguador de dirección

La regulación estándar se obtiene girando el botón en sentido contrario a las agujas del reloj hasta el final de la carrera; en esta posición el amortiguador da la menor resistencia a la acción de la dirección.

Sobre la base de las propias necesidades de conducción es posible aumentar de manera gradual la acción de frenado del amortiguador de la dirección girando el botón en el sentido de las agujas del reloj.

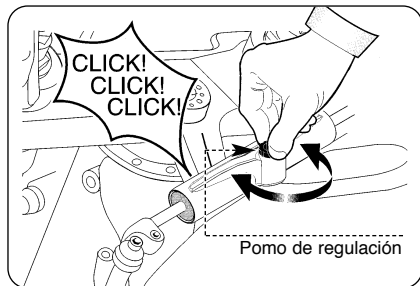



5.7. Regulación de la suspensión delantera

**PELIGRO**

Es fundamental que las regulaciones de ambas barras de la horquilla se encuentren en la misma posición.

NOTA

La regulación de las suspensiones se debe realizar preferiblemente con el depósito del combustible lleno.

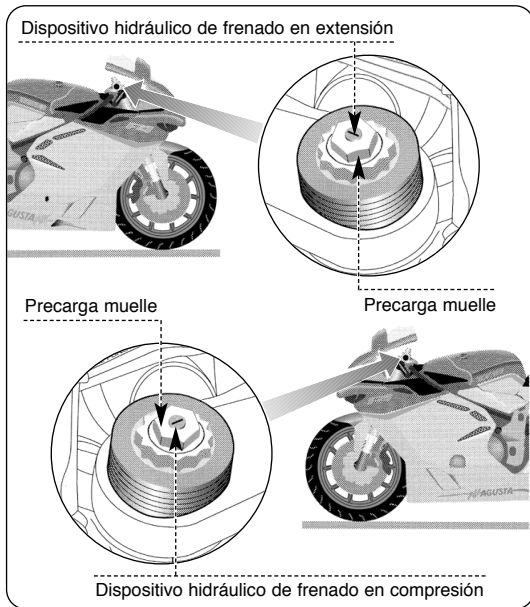



5.7.1. Precarga muelle (suspensión delantera)

La regulación se debe efectuar partiendo de la posición standard. Para encontrar tal posición es necesario girar en sentido contrario a las agujas del reloj hasta el tope, después en sentido horario hasta la posición standard (véase tabla adjunta). Gire en sentido horario para aumentar la precarga muelle, o bien gire en sentido contrario a las agujas del reloj para disminuirla.

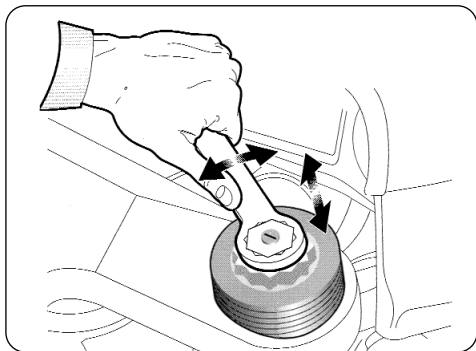

5.7.2. Dispositivo hidráulico de frenado en extensión (suspensión delantera)

La regulación se debe efectuar partiendo de la posición standard. Para encontrar tal posición es necesario girar en sentido horario hasta el tope, después en sentido contrario a las agujas del reloj hasta la posición standard (véase tabla). Gire en sentido horario para aumentar la acción de frenado, o bien gire en sentido contrario a las agujas del reloj para disminuirla.

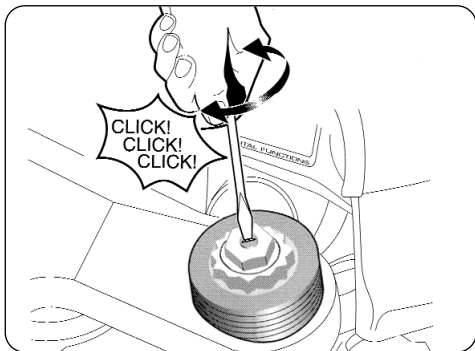



5.7.3. Dispositivo hidráulico de frenado en compresión (suspensión delantera)

La regulación se debe efectuar partiendo de la posición standard. Para encontrar tal posición es necesario girar en sentido horario hasta el tope, después en sentido contrario a las agujas del reloj hasta la posición standard (véase tabla). Gire en sentido horario para aumentar la acción de frenado, o bien gire en sentido contrario a las agujas del reloj para disminuirla.

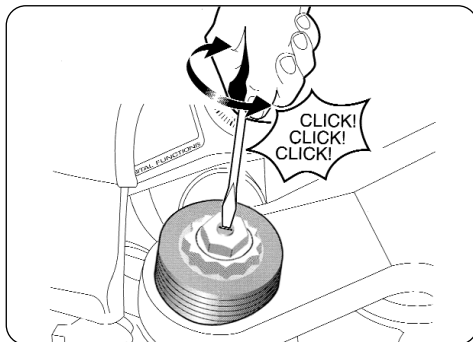



5.8. Regulación de la suspensión trasera



PELIGRO: La alta temperatura del tubo de escape puede provocar quemaduras. Apagar el motor y esperar que los tubos de escape se hayan enfriado antes de efectuar la regulación.



PELIGRO: El amortiguador contiene gas de alta presión. No intentar de ninguna manera efectuar el desmontaje.



PRUDENCIA: Para evaluar el ajuste de la suspensión no actuar de ninguna manera sobre los terminales de carga, puesto que se dañarían.

NOTA: A la entrega, la suspensión trasera se regula en la posición standard (ver tabla adjunta).

NOTA: La regulación de las suspensiones se debe realizar preferiblemente con el depósito del combustible lleno.

ES 5

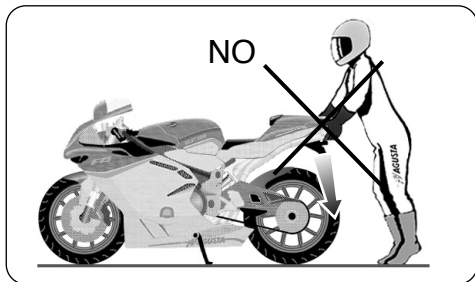
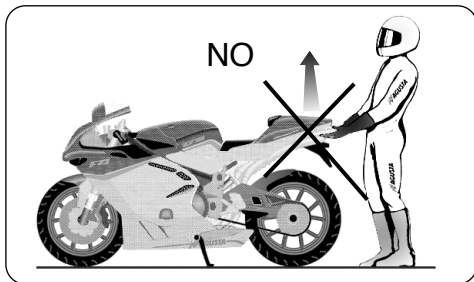



Precarga muelle Dispositivo hidráulico de frenado en compresión (para alta velocidad)

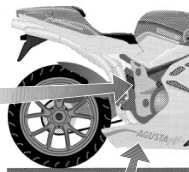
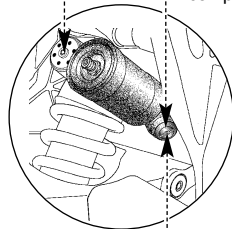

Dispositivo hidráulico de frenado en compresión (para baja velocidad)

Dispositivo hidráulico de frenado en extensión

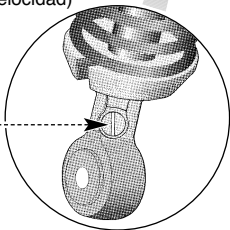

5.8.1. Precarga muelle (suspensión trasera)

La regulación se debe efectuar partiendo de la posición standard. Para encontrar tal posición es necesario girar en sentido contrario a las agujas del reloj hasta el tope, después en sentido horario hasta la posición standard (véase tabla adjunta). Gire en sentido horario para aumentar la precarga muelle, o bien gire en sentido contrario a las agujas del reloj para disminuirla.



PRUDENCIA: No rote el tornillo más allá de su posición completamente a la derecha o a la izquierda, para evitar el daño del dispositivo hidráulico.

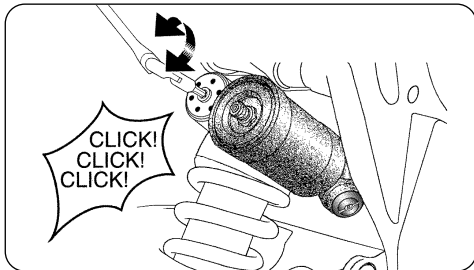



5.8.2. Dispositivo hidráulico de frenado en extensión (suspensión trasera)

El ajuste se debe efectuar partiendo de la posición standard. Para encontrar tal posición es necesario girar en sentido horario hasta el tope, después en sentido contrario a las agujas del reloj hasta la posición standard (véase tabla). Gire en sentido horario para aumentar la acción de frenado, o bien gire en sentido contrario a las agujas del reloj para disminuirla.

5.8.3. Dispositivo hidráulico de frenado en compresión para alta velocidad (suspensión trasera)

La regulación se debe efectuar partiendo de la posición standard. Para encontrar tal posición es necesario girar en sentido contrario a las agujas del reloj hasta el tope, después en sentido horario hasta la posición standard (véase tabla). Gire en sentido horario para aumentar la acción de frenado, o bien gire en sentido contrario a las agujas del reloj para disminuirla.

5.8.4. Dispositivo hidráulico de frenado en compresión para baja velocidad (suspensión trasera)

La regulación se debe efectuar partiendo de la posición standard. Para encontrar tal posición es necesario girar en sentido horario hasta el tope, después en sentido contrario a las agujas del reloj hasta la posición standard (véase tabla). Gire en sentido horario para aumentar la acción de frenado, o bien gire en sentido contrario a las agujas del reloj para disminuirla.

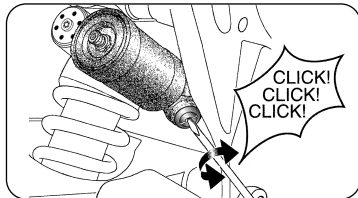
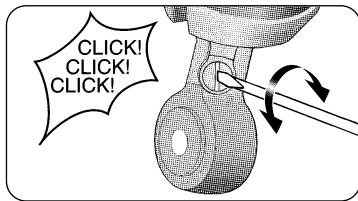



5.9. Ajuste proyector delantero

Colocar el vehículo a 10 metros de distancia de una pared vertical.

Asegurarse que el piso esté plano y que el eje óptico del proyector se encuentre perpendicular a la pared. El vehículo debe estar en posición vertical. Medir la altura del centro del proyector desde el suelo y marcar a esa altura la pared con una cruz.

Prendiendo la luz de cruce, el límite de demarcación entre la zona oscura y la zona iluminada debe resultar a una altura no superior a $9/10$ de la altura desde el suelo del centro del proyector.

Para la regulación horizontal del faro el range de valores es de $\pm 4^\circ$.

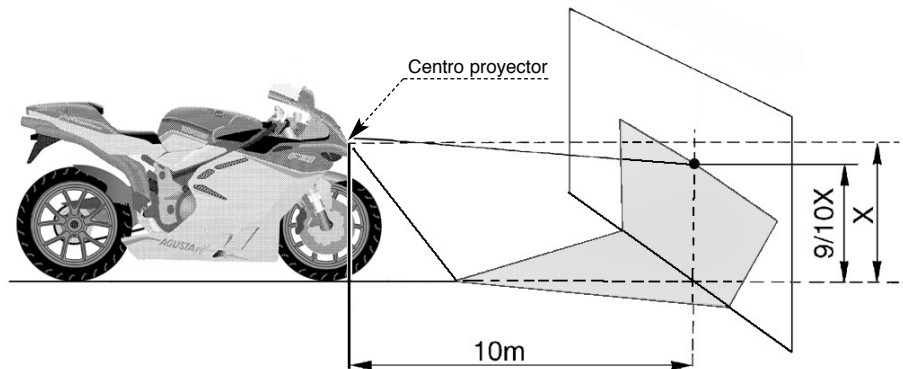



Nota informativa

MV Agusta S.p.A. está comprometida en una política de continuo mejoramiento de sus productos; por este motivo es posible encontrar ligeras diferencias entre el contenido de éste documento y el vehículo adquirido por Ustedes. Los modelos MV Agusta son exportados en muchos Países, en los cuales el Código del Tránsito y a los procedimientos de homologación son distintos a los nuestros.

Confiamos en Vuestra comprensión. MV Agusta S.p.A. considera por lo tanto necesario reservarse el derecho de aportar modificaciones a sus productos y a la documentación técnica en cualquier momento y sin ningún aviso previo.

Sugerimos para visitar a menudo el sitio Internet **www.mvagusta.it** para obtener informaciones y actualizaciones sobre los productos MV Agusta y la documentación relacionada.



Respetemos y defendamos el medioambiente

Todo lo que hacemos tiene repercusiones para todo el planeta y en sus recursos.

MV Agusta, a tutela de los intereses de la comunidad, sensibiliza los Clientes y los operadores de la asistencia técnica a adoptar una utilización del vehículo y de eliminación de sus partes, respetando plenamente las normativas vigentes en términos de contaminación del medio ambiente, eliminación y reciclaje de los desechos.

© 2007

Está prohibida la reproducción aunque sea parcial de éste documento sin el consentimiento escrito por MV Agusta S.p.A.

Part. n° 8000B1113

Edición n° 1 - Noviembre 2007

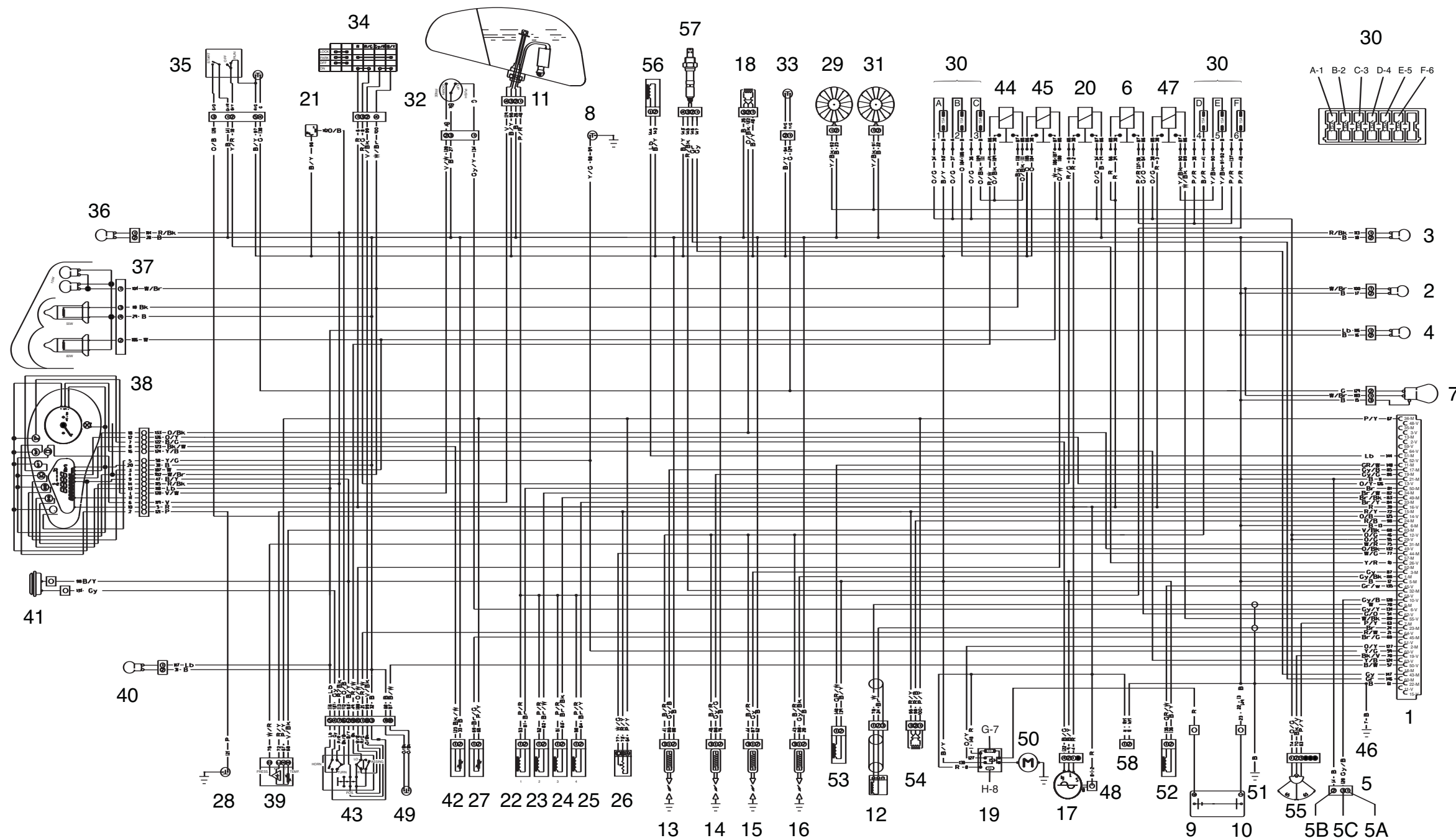

Legenda componenti	
Rif.	Descrizione
1	Centralina
2	Luce targa
3	Indicatore destro
4	Indicatore sinistro
5	Connettore diagnosi (5A-Linea seriale RX; 5B-Ground; 5C-Linea seriale TX)
6	Relé di potenza
7	Fanale posteriore - Stop
8	Interruttore folle
9-10	Batteria
11	Pompa - Sonda benzina
12	Sensore giri motore
13-14	Bobine
15-16	Bobine
17	Alternatore
18	Sensore velocità
19	Teleruttore
20	Relé alimentazione generale

Legenda componenti	
Rif.	Descrizione
21	Intermittenza
22-23	Iniettori
24-25	Iniettori
26	Potenziometro farfalla
27	Sensore temperatura acqua per centralina
28	Interruttore olio
29	Elettroventola
30	Fusibili
31	Elettroventola
32	Interruttore stampella laterale
33	Interruttore stop posteriore
34	Interruttore chiave
35	Interruttore di sicurezza e stop anteriore
36	Indicatore destro
37	Fanale anteriore
38	Cruscotto
39	Sensore pressione/temperatura aria
40	Indicatore sinistro

Legenda componenti	
Rif.	Descrizione
41	Avvisatore acustico
42	Sensore temperatura acqua per cruscotto
43	Interruttore luci
44	Relé luce anabbagliante
45	Relé luce abbagliante
46	Massa telaio - centralina
47	Relé ventole
48	Ricarica batteria
49	Interruttore frizione
50	Motorino avviamento
51	Massa motore
52	Valvola antisaltellamento
53	Valvola TSS
54	Sensore giri camme
55	Interruttore angolare
56	Sistema aria secondaria
57	Sonda lambda
58	Connessione per kit ricarica batteria

Legenda colori cavi	
Lettera/e	Colore
R	Rosso
Y	Giallo
B	Blu
G	Verde
W	Bianco
Bk	Nero
P	Rosa
V	Viola
Sb	Azzurro
Gr	Grigio
O	Arancio
Br	Marrone

Nei colori combinati è indicato il colore di fondo e la marcatura. Es.: Br/Bk.

Legenda fusibili		
Rif.	Amperaggio (A)	Utilizzo
A-1	15	Cruscotto - Sensore velocità - Avvisatore acustico - Luci di posizione
B-2	15	Faro abbagliante
C-3	15	Faro anabbagliante
D-4	15	Bobine - Centralina
E-5	15	Ventole di raffreddamento
F-6	15	Pompa benzina - Iniettori
G-7	40	Ricarica batteria
H-8	40	Scorta per ricarica batteria

Parts list	
Ref.	Description
1	Power unit
2	Plate light
3	Turn indicator, right hand
4	Turn indicator, left hand
5	Diagnosis connector (5A-Serial line RX, 5B-Ground, 5C-Serial line TX)
6	Power relay
7	Brake light
8	Neutral switch
9-10	Battery
11	Pump - Low fuel probe
12	Engine rpm sensor
13	Coil
14	Coil

Parts list	
Ref.	Description
15	Coil
16	Coil
17	Alternator
18	Speed sensor
19	Solenoid starter
20	Main relay
21	Intermittence
22-23	Injectors
24-25	
26	Throttle potentiometer
27	Water temperature sensor for power unit
28	Oil switch
29	Heater fan
30	Fuses

Parts list	
Ref.	Description
31	Heater fan
32	Side stand switch
33	Rear brake switch
34	Key switch
35	Safety and front brake switch
36	Turn indicator, right hand
37	Front light
38	Display
39	Air pressure/temperature sensor
40	Turn indicator, left hand
41	Horn
42	Water temperature sensor for display thermometer
43	Light switch
44	Low beam relay

Parts list	
Ref.	Description
45	High beam relay
46	Frame-power unit ground
47	Heater fan relay
48	Battery recharge
49	Clutch switch
50	Starter
51	Engine ground
52	Antidumping solenoid
53	TSS valve
54	Camshaft rpm sensor
55	Angular switch
56	Secondary air system
57	Lambda sensor
58	Battery recharge kit connection

Wire colors list	
Letter(s)	Color
R	Red
Y	Yellow
B	Blue
G	Green
W	White
Bk	Black
P	Pink
V	Violet
Sb	Sky blue
Gr	Grey
O	Orange
Br	Brown

In combined colors, background and marking colors have been pointed out. E.g. : Br/Bk.

Fuses list		
Ref.	Amperage (A)	Application
A-1	15	Display - Speed sensor - Horn - Parking lights
B-2	15	High beam
C-3	15	Low beam
D-4	15	Coils - Power unit
E-5	15	Heater fans
F-6	15	Fuel pump - Injectors
G-7	40	Battery recharge
H-8	40	Battery recharge supply

Légende des composants	
Réf.	Description
1	Boîtier d'allumage
2	Eclaireur de plaque
3	Clignotant D
4	Clignotant G.
5	Connecteur doagnostic (5A-ligne sérielle RX; 5B-Ground; 5C-ligne sérielle TX)
6	Relais de puissance
7	Feu arrière "Stop"
8	Contacteur de point mort
9-10	Batterie
11	Pompe - Sonde essence
12	Capteur compte tours
13	Bobine
14	Bobine

Légende des composants	
Réf.	Description
15	Bobine
16	Bobine
17	Alternateur
18	Capteur de vitesse
19	Télérupteur
20	Relais alimentation générale
21	Centrale clignotante
22-23	Injecteurs
24-25	
26	Potentiomètre papillon
27	Capteur de température d'eau pour boîtier
28	Manocontact d'huile
29	Electroventilateur
30	Fusibles

Légende des composants	
Réf.	Description
31	Electroventilateur
32	Contacteur de béquille latérale
33	Contacteur de stop arrière
34	Contacteur principal à clé
35	Contacteur de sûreté et stop avant
36	Clignotant D.
37	Feu avant
38	Tableau de bord
39	Capteur de pression / température d'air
40	Clignotant G.
41	Avertisseur sonore
42	Capteur température d'eau pour thermomètre de bord
43	Contacteur d'éclairage
44	Relais feu de croisement

Légende des composants	
Réf.	Description
45	Relais feu de route
46	Masse cadre - boîtier
47	Relais ventilateurs
48	Charge batterie
49	Contacteur embrayage
50	Démarrateur électrique
51	Masse moteur
52	Solenoid anti-houblonnage
53	Valve TSS
54	Capteur compte tours arbre a cames
55	Contacteur angulaire
56	Système de l'air secondaire
57	Sonde Lambda
58	Connexion pour kit recharge de batterie

Légende couleur des câbles	
Lettre(s)	Couleur
R	Rouge
Y	Jaune
B	Bleu
G	Vert
W	Blanc
Bk	Noir
P	Rose
V	Violet
Sb	Bleu ciel
Gr	Gris
O	Orange
Br	Marron

Pour les couleurs combinés, la couleur de fond et le marquage sont indiqués. Par ex. Br/Bk.

Légende des fusibles		
Réf.	Ampérage (A)	Emploi
A-1	15	Tableau de bord - Capteur de vitesse - Avertisseur - Feu de position
B-2	15	Feux de route
C-3	15	Feux de croisement
D-4	15	Bobines - Boîtier d'allumage
E-5	15	Ventilateurs de refroidissement
F-6	15	Pompe à essence - Injecteurs
G-7	40	Charge batterie
H-8	40	Recharge fusible de batterie

Zeichenerklärung Bauteile	
Nr.	Beschreibung
1	Zündbox
2	Nummernschildbeleuchtung
3	Rechter Blinker
4	Linker Blinker
5	Diagnoseanschluß (5A-serielle Linie RX; 5B-Erde; 5C-serielle Linie TX)
6	Kraftrelais
7	Rücklicht - Bremslicht
8	Schalter Leerlauf
9-10	Batterie
11	Pumpe - Benzinstandgeber
12	Sensor Motordrehzahl
13	Spule
14	Spule

Zeichenerklärung Bauteile	
Nr.	Beschreibung
15	Spule
16	Spule
17	Lichtmaschine
18	Geschwindigkeitssensor
19	Fernrelais
20	Relais Hauptversorgung
21	Blinkgeber
22-23	Einspritzdüsen
24-25	
26	Potentiometer Drosselventil
27	Temperaturfühler Wassertemperatur für Kontrollbox
28	Öldruckschalter
29	Gebälse
30	Sicherungen

Zeichenerklärung Bauteile	
Nr.	Beschreibung
31	Gebälse
32	Schalter Seitenständer
33	Hinterer Bremslichtschalter
34	Zündschloß
35	Sicherheits- und vorderer Bremslichtschalter
36	Rechter Blinker
37	Vorderer Scheinwerfer
38	Armaturenbrett
39	Drucksensor/Lufttemperatur
40	Linker Blinker
41	Hupe
42	Wassertemperaturfühler-Thermometer Armaturenbrett
43	Lichtschalter
44	Fahrlichtrelais

Zeichenerklärung Bauteile	
Nr.	Beschreibung
45	Fernlichtrelais
46	Masse Rahmen - Kontrollbox
47	Gebälserelais
48	Batterieladung
49	Kupplungsschalter
50	Anlassermotor
51	Masse Motor
52	Anti-Hopfen-Solenoid
53	Ventil TSS
54	Sensor Nockenwelledrehzahl
55	Eckiger Schalter
56	Sekundärluftsystem
57	Lambdasonde
58	Batterieladung Bausatz Anschluß

Zeichenerklärung Kabelfarben	
Buchstabe(n)	Farbe
R	Rot
Y	Gelb
B	Blau
G	Grün
W	Weiß
Bk	Schwarz
P	Rose
V	Violett
Sb	Hellblau
Gr	Grau
O	Orange
Br	Braun

Bei Farbkombinationen wird die Grundfarbe und die Markierung angegeben. Z. B. Br/Bk.

Zeichenerklärung Sicherungen		
Nr.	Ampereleistung (A)	Einsatz
A-1	15	Armaturenbrett - Geschwindigkeitssensor - Hupe - Standlicht
B-2	15	Fernlicht
C-3	15	Fahrlicht
D-4	15	Spulen - Zündbox
E-5	15	Kühlgebläse
F-6	15	Benzinpumpe - Einspritzdüsen
G-7	40	Batterieladung
H-8	40	Ersatz für Batterieladung

Leyenda Componentes	
Ref.	Descripción
1	Central
2	Luz matrícula
3	Indicador derecho
4	Indicador izquierdo
5	Conector diagnóstico (5A-Línea serial RX; 5B-Ground; 5C-Línea serial TX)
6	Relé de potencia
7	Faro trasero - Stop
8	Interruptor punto muerto
9-10	Batería
11	Bomba - Sonda gasolina
12	Sensor revoluciones motor
13	Bobina
14	Bobina

Leyenda Componentes	
Ref.	Descripción
15	Bobina
16	Bobina
17	Alternador
18	Sensor velocidad
19	Teleruptor
20	Relé alimentación general
21	Intermitencia
22-23	Inyectores
24-25	
26	Potenciómetro mariposa
27	Sensor temperatura agua para central
28	Interruptor aceite
29	Electroventilador
30	Fusibles

Leyenda Componentes	
Ref.	Descripción
31	Electroventilador
32	Interruptor pata lateral
33	Interruptor stop trasero
34	Interruptor llave
35	Interruptor de seguridad y stop delantero
36	Indicador derecho
37	Faro delantero
38	Cuadro mandos
39	Sensor presión/ temperatura aire
40	Indicador izquierdo
41	Claxon
42	Sensor temperatura agua para termómetro display
43	Interruptor luces
44	Relé luz cruce

Leyenda Componentes	
Ref.	Descripción
45	Relé luz carretera
46	Masa chasis - central
47	Relé ventiladores
48	Recarga batería
49	Interruptor embrague
50	Motor de arranque
51	Masa motor
52	Solenoid anti-lupulización
53	Válvula TSS
54	Sensor revoluciones árbol de levas
55	Interruptor angular
56	Sistema de aire secundario
57	Sonda Lambda
58	Conexión del kit recarga batería

Leyenda colores cables	
Letra/s	Color
R	Rojo
Y	Amarillo
B	Azul marino
G	Verde
W	Blanco
Bk	Negro
P	Rosa
V	Violeta
Sb	Azul
Gr	Gris
O	Naranja
Br	Marrón

En los colores combinados se indica el color de fondo y la marcación Ej. Br/Bk.

Leyenda fusibles		
Ref.	Amperaje (A)	Utilización
A-1	15	Cuadro mandos - Sensor velocidad - Claxon - Luces de posición
B-2	15	Faro carretera
C-3	15	Faro cruce
D-4	15	Bobinas - Central
E-5	15	Ventilador de refrigeración
F-6	15	Bomba gasolina - Inyectores
G-7	40	Recarga batería
H-8	40	Repuesto para recarga batería

I Posizionamento e montaggio dei terminali (capicorda) sulla batteria.

- Effettuare la carica iniziale della batteria secondo le istruzioni riportate nella rispettiva confezione.
- Applicare il termoriflettente (**Part. N. 8000A2762**) sulla batteria secondo la disposizione indicata in **Fig. A**. Inserire la batteria nell'apposito supporto posizionato sul telaio posteriore.
- Montare il terminale positivo (+) sul relativo polo della batteria come indicato in **Fig. B** e in **Fig. C**. Stringere la vite utilizzando una coppia di serraggio pari a **7÷8 Nm**.
- A montaggio avvenuto sistemare la **cuffia di protezione** sul polo positivo (**Fig. D**).
- Montare i **2 terminali negativi (-)** sul relativo polo della batteria (**Fig. E**). Stringere la vite utilizzando una coppia di serraggio pari a **7÷8 Nm**.

⚠ ATTENZIONE: Assicurarsi che il cavo del terminale positivo sia posizionato all'interno della struttura del telaio posteriore (Vedi Fig. E).

- I cavi di collegamento alla batteria devono passare al di sotto del **supporto rotazione sella**.

GB Terminals (wire terminals) positioning and fitting on the battery.

- Perform the initial charge of the battery according to the instruction sheet enclosed in its package.
- Apply the thermoreflector (**Part No. 8000A2762**) on the battery according to the configuration shown in **Fig. A**. Insert the battery in the corresponding support placed on the rear frame.
- Fit the positive terminal (+) on the relevant battery pole, as shown in **Fig. B** and **Fig. C**. Tighten the screw at torque **7÷8 Nm**.

- Afterwards, fit the **protection cap** on the positive pole (**Fig. D**).

- Fit the **2 negative terminals (-)** on the relevant battery pole (**Fig. E**). Tighten the screw at torque **7÷8 Nm**.

⚠ WARNING: Make sure that the wire of the positive terminal is placed within the rear frame (See Fig. E).

- The battery connection cables must pass under the **saddle rotation support**.

F Positionnement et montage des terminaux (cosses) sur la batterie.

- Exécutez la charge initiale de la batterie selon les instructions incluses en son paquet.
- Appliquez le thermoreflecteur (**Pièce N. 8000A2762**) sur la batterie selon la configuration représentée sur la **Fig. A**. Insérez la batterie dans le support correspondant placé sur le cadre arrière.
- Monter le terminal positif (+) sur le pôle correspondant de la batterie comme montré en les **Fig. B** et **Fig. C**. Serrer la vis en utilisant un couple de serrage égal à **7÷8 Nm**.
- Au terme du montage, placer la **calotte de protection** sur le pôle positif (**Fig. D**).
- Monter les **deux** terminaux négatifs (-) sur le pôle correspondant de la batterie (**Fig. E**). Serrer la vis en utilisant un couple de serrage égal à **7÷8 Nm**.

⚠ ATTENTION: Veiller à ce que le câble de la borne du positif soit positionné à l'intérieur de la structure du cadre arrière (voir Fig. E).

- Les câbles de connexion à la batterie doivent passer sous le **support de rotation de la selle**.

D Anbringung und Montage der Kabelanschlüsse an der Batterie

- Führen Sie die Batterieaufladung, nach Instruktionen aus, die in seinem Paket eingeschlossen sind.
- Wenden Sie das Hitzeschutz (**Teil Nr. 8000A2762**) auf der Batterie nach der Konfiguration an, die auf der **Fig. A** dargestellt wurde. Fügen Sie die Batterie in den Träger ein, der auf den hinterer Rahmen gesetzt wurde.
- Das Pluskabelende (+) am Pluspol der Batterie anbringen, wie in **Fig. B** und **Fig. C** gezeigt. Die Schraube mit einem Drehmoment von **7 ÷ 8 Nm** festziehen.
- Nach der Montage die **Schutzkappe** über den Pluspol ziehen (**Fig. D**).
- Die beiden Kabelanschlüsse (-) am Minuspol der Batterie anbringen (**Fig. E**). Die Schraube mit einem Drehmoment von **7 ÷ 8 Nm** festziehen.

⚠ ACHTUNG: Sicherstellen, dass das Kabel zum Pluspol der Batterie innerhalb der Struktur des hinteren kleinen Rahmens angebracht wird (siehe Fig. E).

- Die Batteriekabel müssen unter dem **Sattel-Drehpunkt** durchgeführt werden.

E Colocación y montaje de los terminales (terminales de cable) en la batería.

- Realice la carga inicial de la batería según las instrucciones incluidas en su paquete.
- Aplique el termoreverberante (**Pieza N. 8000A2762**) en la batería según la configuración demostrada en la **Fig. A**. Inserte la batería en el correspondiente soporte puesto en el chasis trasero.
- Montar el terminal positivo (+) sobre el correspondiente polo de la batería, según lo demostrado en la **Fig. B** y en la **Fig. C**. Apretar el tornillo utilizando un par de apriete igual a **7÷8 Nm**.
- Una vez finalizado el montaje colocar el **capuchón de protección** sobre el polo positivo (**Fig. D**).
- Montar los **dos** terminales negativos (-) sobre el correspondiente polo de la batería (**Fig. E**). Apretar el tornillo utilizando un par de apriete igual a **7÷8 Nm**.

⚠ PELIGRO: Asegurarse que el cable del terminal positivo se encuentre en el interior de la estructura del chasis trasero (Ver Fig. E).

- Los cables de conexión a la batería deben pasar por debajo del **soporte rotación sillín**.

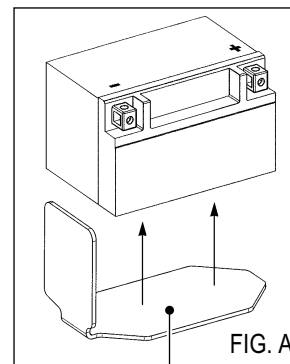

TERMORIFLETTENTE
THERMOREFLECTOR
THERMOREFLECTEUR
HITZESCHUTZ
TERMOREVERBERANTE

SUPPORTO ROTAZIONE SELLA
SADDLE ROTATION SUPPORT
SUPPORT DE ROTATION DE LA SELLE
SATTEL-DREHPUNKT
SOPORTE ROTACIÓN SILLÍN

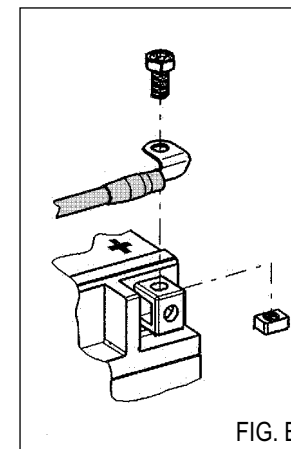

FIG. B

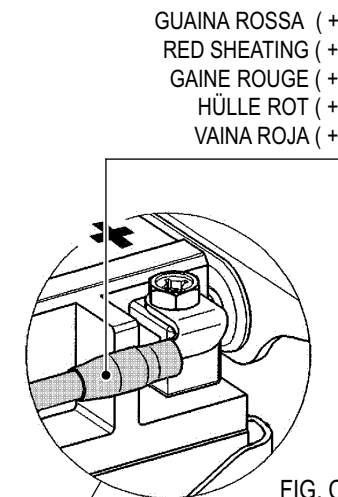
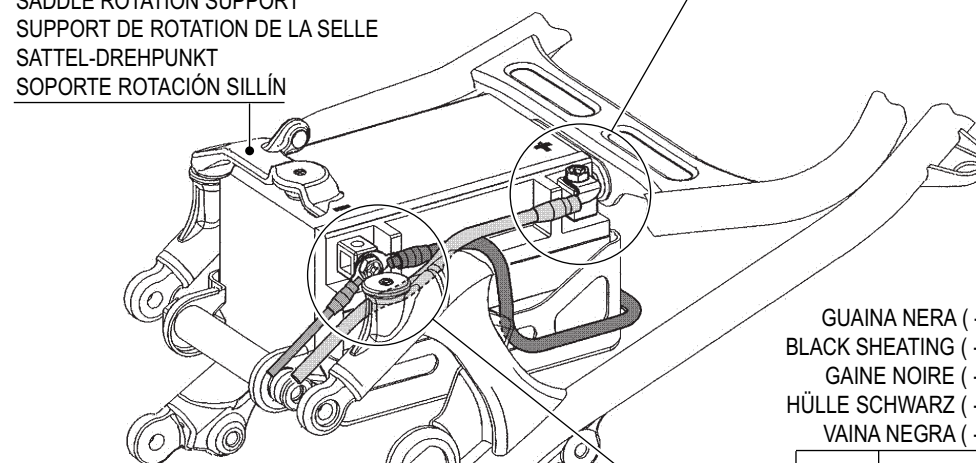

FIG. C

GUAINA ROSSA (+)
RED SHEATING (+)
GAINE ROUGE (+)
HÜLLE ROT (+)
VAINA ROJA (+)



GUAINA NERA (-)
BLACK SHEATING (-)
GAINE NOIRE (-)
HÜLLE SCHWARZ (-)
VAINA NEGRA (-)

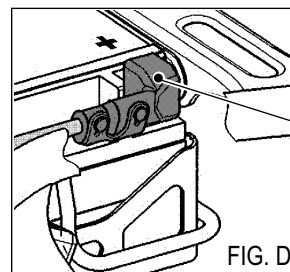

FIG. D

CUFFIA DI PROTEZIONE
PROTECTION CAP
CALOTTE DE PROTECTION
SCHUTZKAPPE
CAPUCHÓN DE PROTECCIÓN

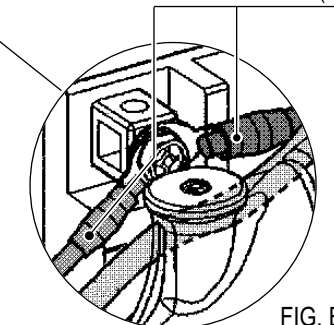

FIG. E

- Dispositivo idraulico di frenatura in estensione
- Rebound damping hydraulic device
- Dispositif hydraulique de freinage en détente
- Hydraulische Ausdehnungsbremse
- Dispositivo hidráulico de frenado en extensión

- Dispositivo idraulico di frenatura in compressione (Alta velocità)
- Compression damping hydraulic device (High speed)
- Dispositif hydraulique de freinage en compression (Vitesse élevée)
- Hydraulische Kompressionsbremse (Hohe Gänge)
- Dispositivo hidráulico de frenado en compresión (Alta velocidad)

- Dispositivo idraulico di frenatura in compressione (Bassa velocità)
- Compression damping hydraulic device (Low speed)
- Dispositif hydraulique de freinage en compression (Vitesse basse)
- Hydraulische Kompressionsbremse (Niedrige Gänge)
- Dispositivo hidráulico de frenado en compresión (Baja velocidad)

- Precarico molla
- Spring preload
- Précharge du ressort
- Federvorspannung
- Precarga muelle

Precarico molla • Spring preload • Précharge du ressort • Federvorspannung • Precarga muelle

Precarico molla • Spring preload • Précharge du ressort • Federvorspannung • Precarga muelle

Precarico molla • Spring preload • Précharge du ressort • Federvorspannung • Precarga muelle

Precarico molla • Spring preload • Précharge du ressort • Federvorspannung • Precarga muelle

		F4 1000 RR 312 / F4 1078 RR 312		F4 1000 RR 1+1 312 / F4 1078 RR 1+1 312	
		Tipo di assetto - Type of geometry - Type d'assiette - Einstellungsart - Tipo de equilibrado		Tipo di assetto - Type of geometry - Type d'assiette - Einstellungsart - Tipo de equilibrado	
Solo pilota - Rider only - Uniquement pilote - Nur Fahrer - Solo piloto	Sospensione anteriore Front suspension Suspension avant Vordere Federung Suspensión delantera	Su strada On road Sur route Auf Straße En la carretera	In pista On race circuit En circuit de course Auf Rennstrecken En circuito	Su strada On road Sur route Auf Straße En la carretera	In pista On race circuit En circuit de course Auf Rennstrecken En circuito
	Precarico molla Spring preload Précharge du ressort Federvorspannung Precarga muelle	4 giri turns tours Drehzahl revoluciones	3 giri turns tours Drehzahl revoluciones	4 giri turns tours Drehzahl revoluciones	3 giri turns tours Drehzahl revoluciones
	Frenatura in estensione Rebound damping Frein en détente Ausdehnungsbremse Freno en extensión	10 scatti clicks emboitements Rasten disparos	8 scatti clicks emboitements Rasten disparos	10 scatti clicks emboitements Rasten disparos	8 scatti clicks emboitements Rasten disparos
	Frenatura in compressione Compression damping Frein en compression Kompressionsbremse Freno en compresión	10 scatti clicks emboitements Rasten disparos	7 scatti clicks emboitements Rasten disparos	10 scatti clicks emboitements Rasten disparos	7 scatti clicks emboitements Rasten disparos
Con passeggero - With passenger - Avec passager - Mit Beifahrer - Con pasajero	Sospensione posteriore Rear suspension Suspension arrière Hintere Federung Suspensión trasera	Su strada On road Sur route Auf Straße En la carretera	In pista On race circuit En circuit de course Auf Rennstrecken En circuito	Su strada On road Sur route Auf Straße En la carretera	In pista On race circuit En circuit de course Auf Rennstrecken En circuito
	Precarico molla Spring preload Précharge du ressort Federvorspannung Precarga muelle	0 giri turns tours Drehzahl revoluciones	2 giri turns tours Drehzahl revoluciones	0 giri turns tours Drehzahl revoluciones	2 giri turns tours Drehzahl revoluciones
	Frenatura in estensione Rebound damping Freinage en détente Ausdehnungsbremse Frenado en extensión	16 scatti clicks emboitements Rasten disparos	18 scatti clicks emboitements Rasten disparos	16 scatti clicks emboitements Rasten disparos	18 scatti clicks emboitements Rasten disparos
	Frenatura in compressione Compression damping Freinage en compression Kompressionsbremse Frenado en compresión	0 scatti clicks emboitements Rasten disparos	18 scatti clicks emboitements Rasten disparos	0 scatti clicks emboitements Rasten disparos	18 scatti clicks emboitements Rasten disparos
	Frenatura in compressione Compression damping Freinage en compression Kompressionsbremse Frenado en compresión	18 scatti clicks emboitements Rasten disparos	12 scatti clicks emboitements Rasten disparos	18 scatti clicks emboitements Rasten disparos	12 scatti clicks emboitements Rasten disparos
	Precarico molla Spring preload Précharge du ressort Federvorspannung Precarga muelle	—	—	3 giri turns tours Drehzahl revoluciones	—
Frenatura in estensione Rebound damping Freinage en détente Ausdehnungsbremse Frenado en extensión	—	—	14 scatti clicks emboitements Rasten disparos	—	
Frenatura in compressione Compression damping Freinage en compression Kompressionsbremse Frenado en compresión	—	—	6 scatti clicks emboitements Rasten disparos	—	
Frenatura in compressione Compression damping Freinage en compression Kompressionsbremse Frenado en compresión	—	—	16 scatti clicks emboitements Rasten disparos	—	



Motorcycle Art



MV AGUSTA S.p.A. - Via G. Macchi, 144
21100 - Schiranna (VA) - ITALY
www.mvagusta.it Part. N. 8000B1113 Ed. n° 1

