

Wiring Devices – NEMA Wiring Diagrams

Reference material only. Please see Wiring Section in the catalog for product part number.

2-Pole 2-Wire

125V

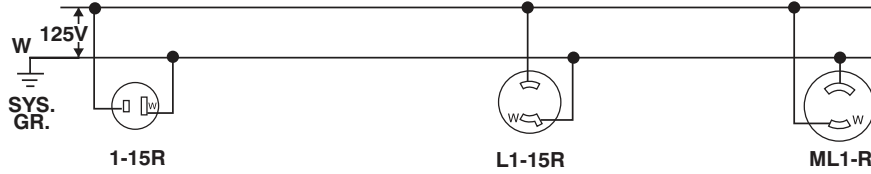

208V or 250V

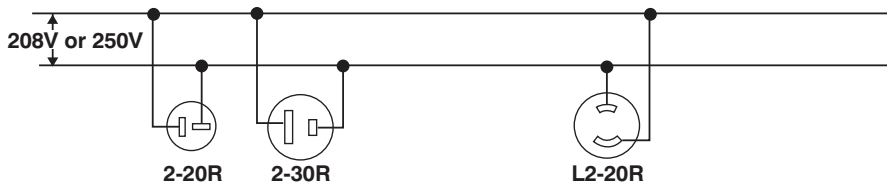

2-Pole 3-Wire Grounding

125V

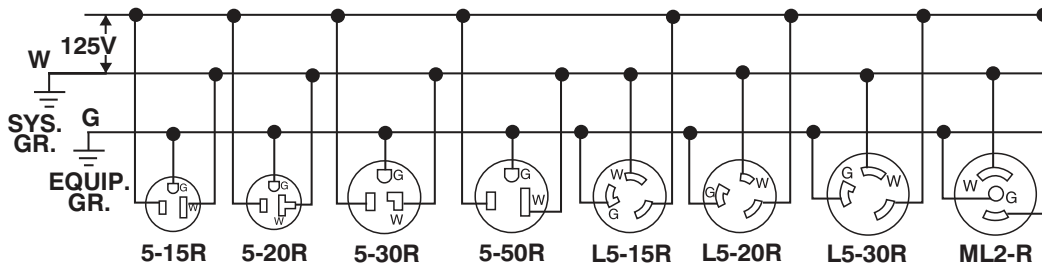

208V or 250V

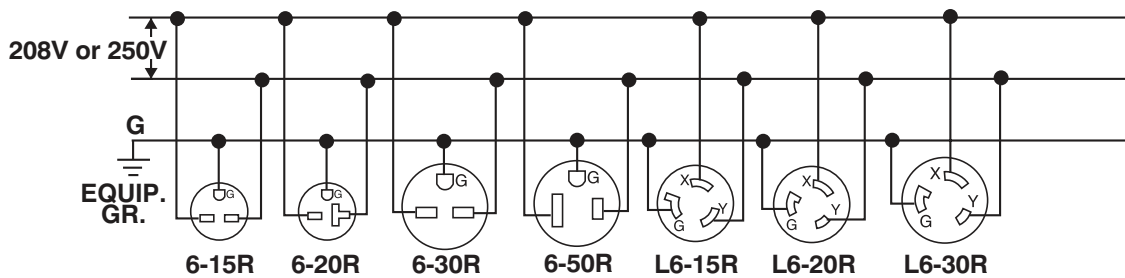

277V AC

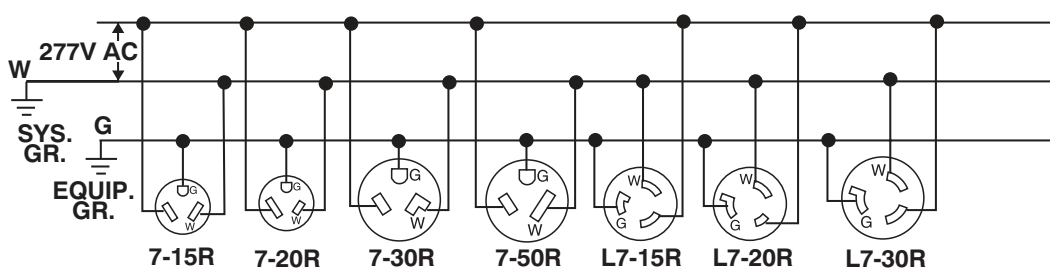

Wiring Devices – NEMA Wiring Diagrams

2-Pole 3-Wire Grounding

480V AC

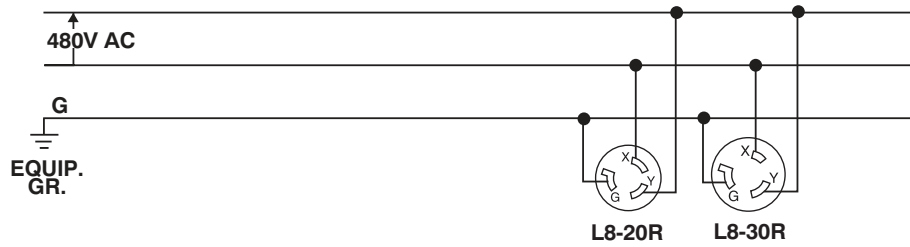

600V AC

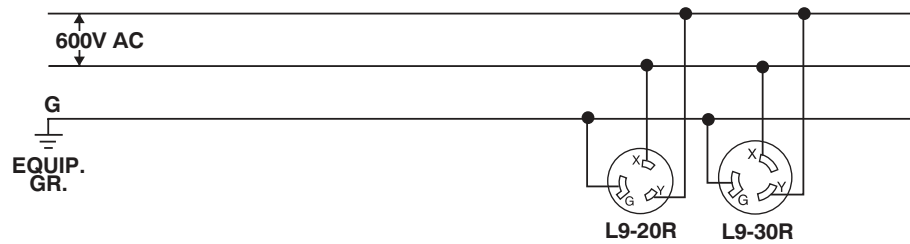

3-Pole 3-Wire

125V/250V AC

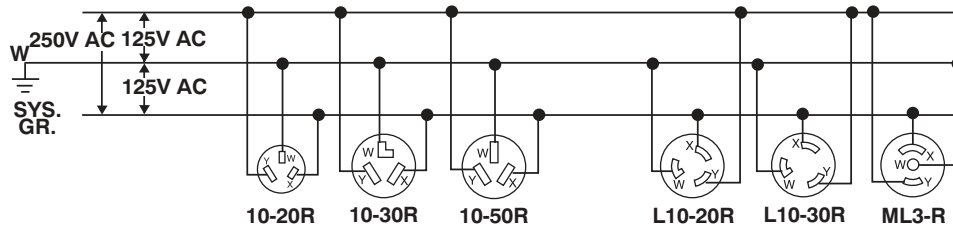

3Ø 250V AC

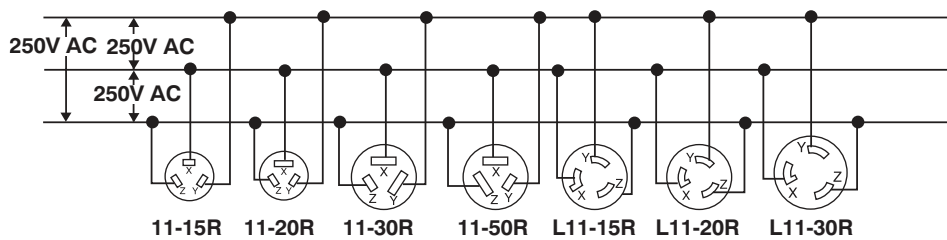

3Ø 480V AC

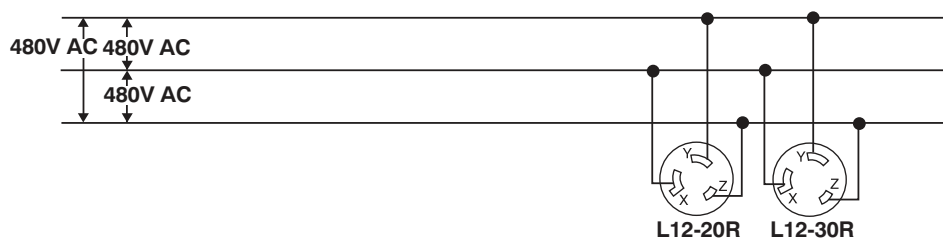

Wiring Devices – NEMA Wiring Diagrams

3-Pole 3-Wire Continued

3 ϕ 600V AC

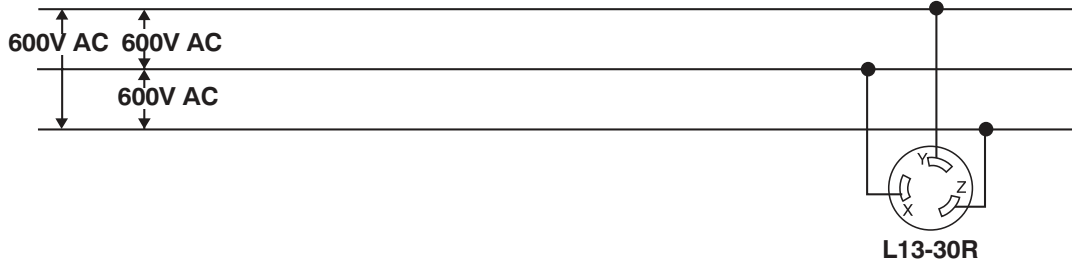

3-Pole 4-Wire Grounding

125/250V AC

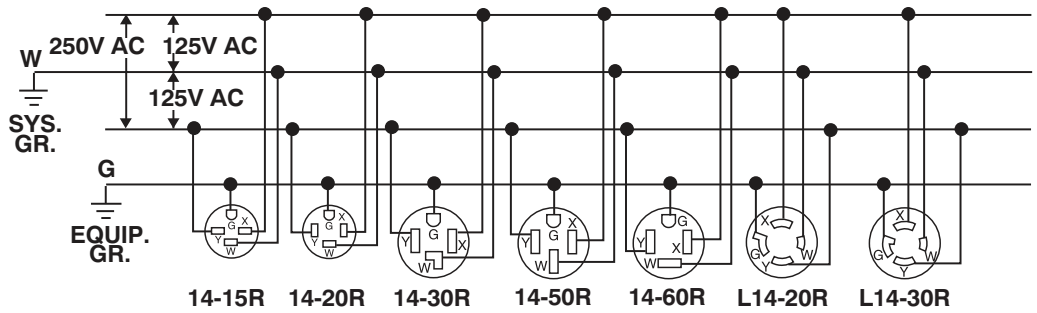

3 ϕ 250V AC

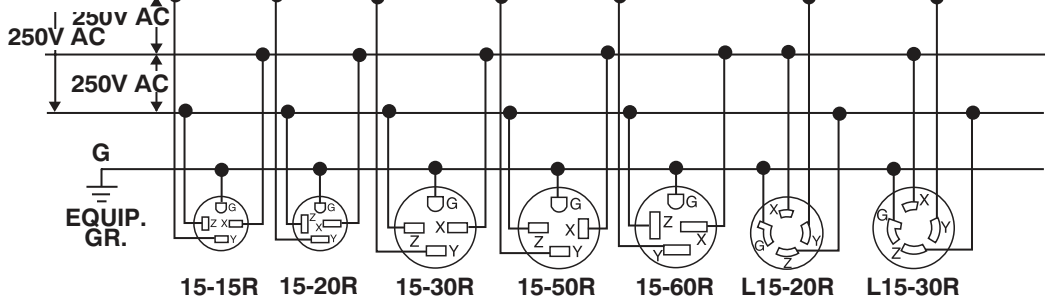

3 ϕ 480V AC

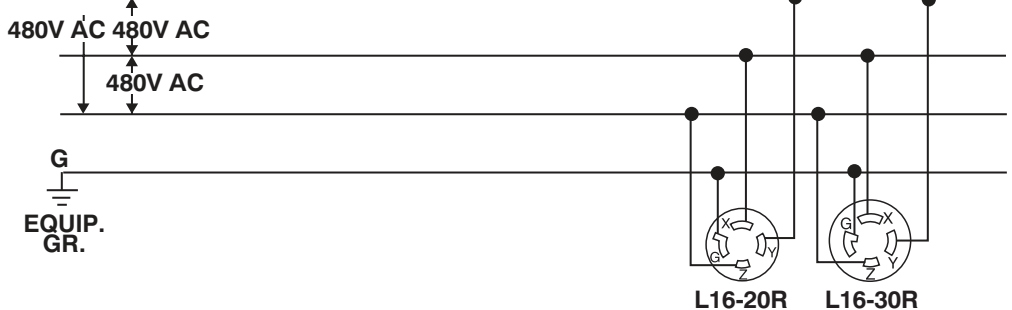

Wiring Devices – NEMA Wiring Diagrams

3-Pole 4-Wire Grounding Continued

3 ϕ 600V AC

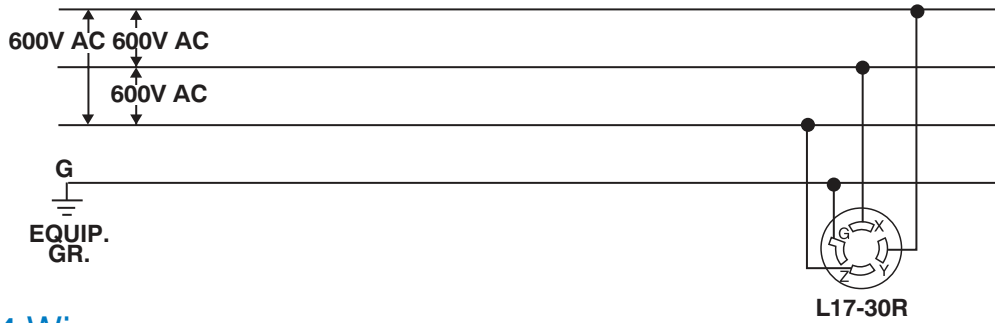

4-Pole 4-Wire

3 ϕ Y 120/208V AC

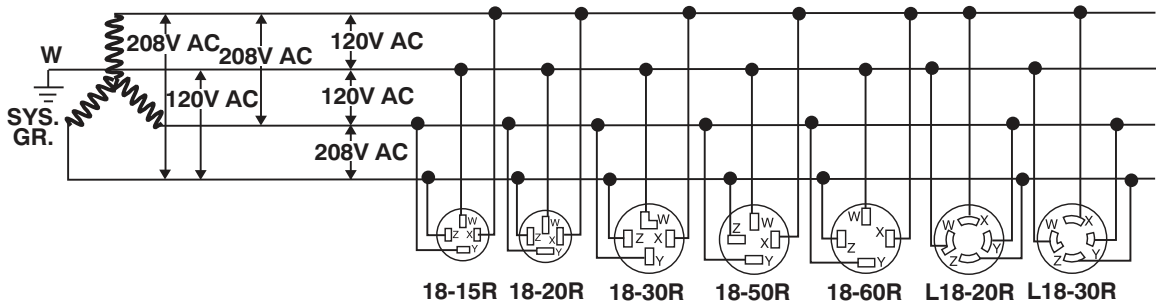

3 ϕ Y 277/480V AC

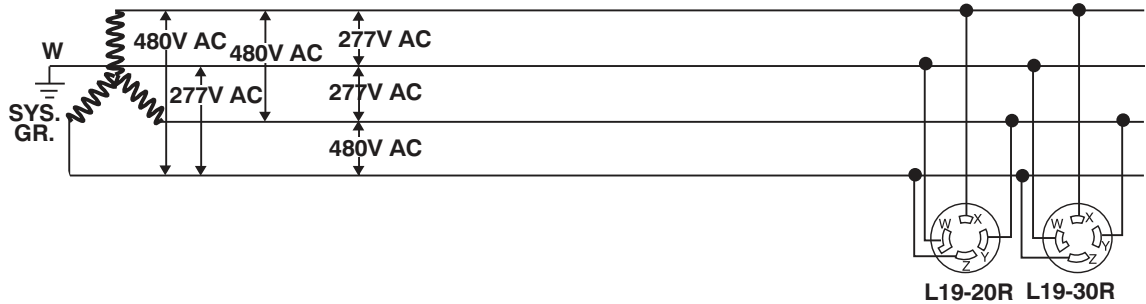

3 ϕ Y 347/600V AC

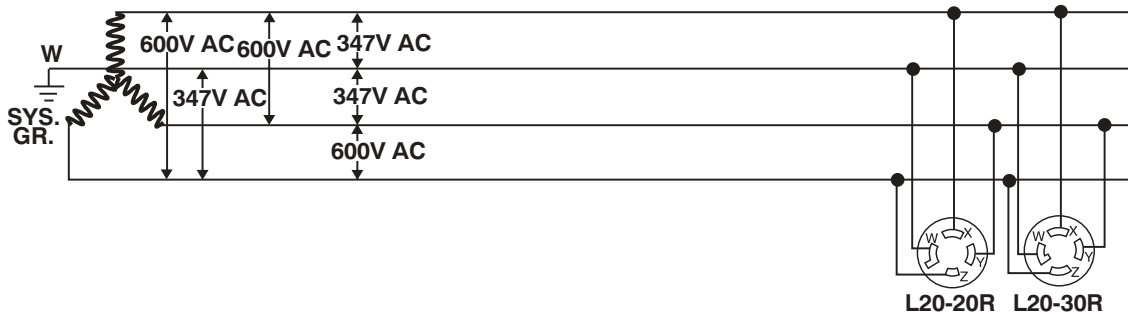

Wiring Devices – NEMA Wiring Diagrams

4-Pole 5-Wire Grounding

3 ϕ Y 120/208V AC

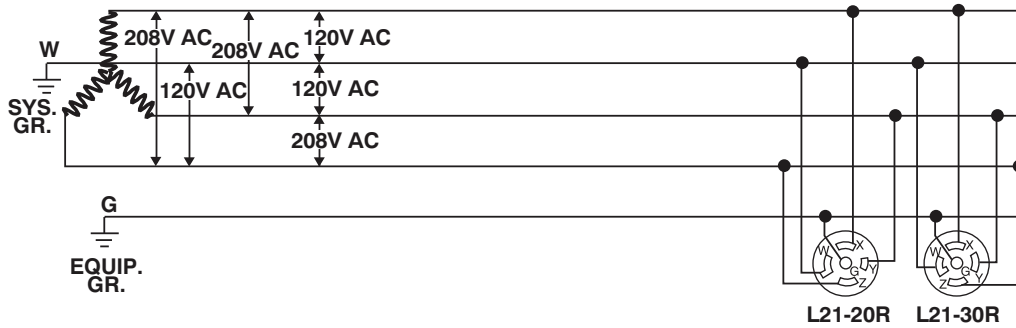

3 ϕ Y 277/480V AC

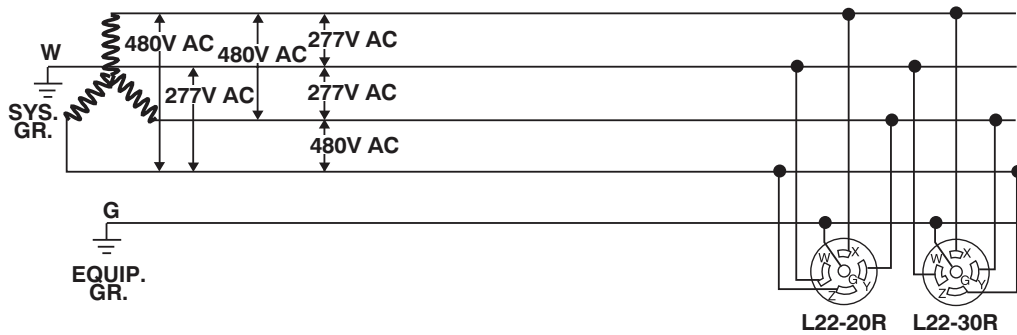

3 ϕ Y 347/600V AC

